

Full Catalog 2012B

**PE PASTERNAK®**



The Broadest Selection of RF & Microwave Components  
and Assemblies Available for Same-Day Shipping...

**Over 40 Years!**



[www.pasternack.com](http://www.pasternack.com)



866-727-8376





# CATALOG SECTION INDEX

Turn the page to the Table of Contents to find individual products, or use the Part Number Index on Pages 253-264 to find the product page for each Part Number.

<b>New Product Additions.....</b>	<b>3</b>	<b>New Product Additions</b>
Low PIM Products; Precision Connectors; High Frequency Attenuators and Terminations; Filters		
<b>Test and Measurement Products.....</b>	<b>5</b>	<b>Test and Measurement</b>
Bench Type Calibration Kits, 3 Port Field Type Calibration Kits; Calibration Kits Components; Bench Type Calibration Kits for VNA Test Cables; Interchangeable Connectors		
<b>Cable Assemblies.....</b>	<b>9</b>	<b>Cable Assemblies</b>
Cable Assemblies Selection Guide; Cable Assemblies Matrix; Cable Assemblies Locator (By Connector Type); Precision and Standard Cable Assemblies		
<b>Connectors.....</b>	<b>78</b>	<b>Connectors</b>
Connector Selection Guide; Connector Locator (By Connector Type); All Connectors		
<b>Adapters.....</b>	<b>137</b>	<b>Adapters</b>
Adapter Selection Guide; Adapters Matrix; Adapter Locator (Part Number Identifier); Adapters to all Connectors		
<b>Coaxial Cables.....</b>	<b>180</b>	<b>Coaxial Cables</b>
75 Ohm Broadcast; Communications; High Performance; RG MIL-C-17 Type Cables; Semi-Rigid & Formable; Twinax		
<b>Attenuators.....</b>	<b>185</b>	<b>Attenuators</b>
Fixed Attenuators; Step Attenuators; Programmable Attenuators; DC Bias Attenuators; Continuously Variable Attenuators		
<b>Terminations and Matching Pads.....</b>	<b>195</b>	<b>Terminations &amp; Matching Pads</b>
RF Load; Feed-Thru Load; Resistive Impedance Transformers		
<b>Couplers and Dividers.....</b>	<b>199</b>	<b>Couplers and Dividers</b>
Single Directional; Dual Directional; Hybrids; Resistive Power Dividers; Reactive Power Dividers		
<b>Misc. RF Components.....</b>	<b>204</b>	<b>Misc. RF Components</b>
Connector Caps; Connector Shorts; DC Blocks; Bias Tees; Bandpass Filters; Lowpass Filters; Highpass Filters; Circulators; Isolators; Phase Trimmers; Phase Shifters; In-Line Surge Protectors; Manual Coax Switch with Surge Protectors; Replacement Cartridges		
<b>Amplifiers, Mixers and Multipliers.....</b>	<b>212</b>	<b>Amplifiers, Mixers and Multipliers</b>
Broadband Amplifiers; Low Noise Amplifiers; Mixers; Multipliers		
<b>Detectors/Limiters &amp; Noise Sources.....</b>	<b>213</b>	<b>Detectors/Limiters &amp; Noise Sources</b>
Zero Biased Detectors; Biased Detectors; Log Detectors; PIN-PIN, PIN-Schottky; Medium Noise Sources; High Noise Sources		
<b>Switches.....</b>	<b>216</b>	<b>Switches</b>
Relay Switches; PIN Switches		
<b>Antennas.....</b>	<b>219</b>	<b>Antennas</b>
Omni Directional Antennas; Directional Antennas; Gain Horn Antennas; NMO Adapters; Magnetic NMO Mount		
<b>Waveguides.....</b>	<b>231</b>	<b>Waveguides</b>
Standard Waveguide Flanges; Grooved Waveguide Flanges; Precision Terminations; Waveguide Terminations; Medium Power Terminations; High Power Terminations		
<b>Fiber Optics.....</b>	<b>235</b>	<b>Fiber Optics</b>
F/O Mode Conditioning Cable Assemblies; F/O Cable Assemblies; Optical Audio Cable Assemblies; F/O Adapters; F/O Loopbacks; F/O Attenuators		
<b>Tools.....</b>	<b>236</b>	<b>Tools</b>
Field Replaceable Tab Contacts; Hermetic Seal Solder Contacts; EMI-RFI Gasket for SMA Connectors; Hardware Miscellaneous; Cable Cutters; Insertion/Extraction Tools; Torque Wrenches; Crimp Tools; Crimp Tool Dies		
<b>Appendix.....</b>	<b>241</b>	<b>Appendix</b>
Connector Identifiers; Mounting Holes; Pasternack REACH and RoHS Compliance Programs; Mailing List Changes; Binding Terms; Glossary of RF Terms; Part Number Index		

# TABLE OF CONTENTS

<b>Adapters</b>	D-Sub Contacts.....	117	Bias Tees.....	206
Adapters to All Connectors.....	F, 75 Ohm.....	128	Circulators.....	208
Locator (Part Number Identifier).....	FAKRA.....	115	Connector Caps and Shorts.....	204
Matrix.....	FME.....	104	DC Blocks.....	205
Quick Reference Guide.....	GR874.....	119	Highpass Filters.....	207
Selection Guide.....	HN.....	107	In-Line Surge Protectors.....	210
	LC.....	107	Isolators.....	208
<b>Amplifiers</b>	MC-CARD.....	117	Lowpass Filters.....	207
Broadband Amplifiers.....	MCX, 50 Ohm.....	111	Manual Coax Switch with Surge Protectors.....	210
Low Noise Amplifiers.....	MCX, 75 Ohm.....	130	Phase Shifters.....	209
	MHV.....	123	Phase Trimmers.....	209
<b>Antennas</b>	MINI SMB, 75 Ohm.....	132	Replacement Cartridges.....	210
Directional, Active GPS.....	MINI SMP.....	110		
Directional, Fixed.....	MINI UHF.....	103	<b>Mixers</b>	
Directional, In Ceiling Dome.....	MMCX.....	110	Mixers.....	212
Directional, Panel.....	N, 50 Ohm.....	94		
Directional, Passive GPS.....	N, 75 Ohm.....	125	<b>Multipliers</b>	
Directional, Yagi.....	QMA.....	108	Multipliers.....	213
Gain Horns.....	QN.....	109		
NMO Adapters.....	RCA.....	134	<b>Noise Generators</b>	
NMO Mount, Magnetic.....	SC.....	106	High Noise Source.....	216
Omni Directional, Fixed.....	SHV.....	124	Medium Noise Source.....	215
Omni Directional, Mobile.....	SMA.....	83		
Omni Directional, Portable.....	SMB, 50 Ohm.....	112	<b>Power Dividers</b>	
Omni Directional, Portable (Rubber Duck).....	SMB, 75 Ohm.....	130	Reactive.....	202
	SMC, 50 Ohm.....	104	Resistive.....	202
<b>Attenuators</b>	SMC, 75 Ohm.....	127		
Continuously Variable.....	SMP.....	109	<b>Switches</b>	
DC Bias.....	SSMA.....	93	PIN.....	217
Fixed.....	SSMB.....	114	Relay.....	216
Programmable.....	TNC, 50 Ohm.....	98		
Steps Attenuators, Dial.....	TNC, 75 Ohm.....	126	<b>Terminations</b>	
Steps Attenuators, Push Button.....	UHF.....	102	Feed-Thru Load.....	198
Steps Attenuators, Toggle.....	UMCX.....	110	RF Load.....	195
<b>Cable Assemblies</b>	<b>Couplers</b>		<b>Test and Measurement Products</b>	
Breakouts.....	Dual Directional.....	201	3 Port Field Type Calibration Kits.....	6
Locator (By connector Type).....	Hybrids.....	202	Bench Type Calibration Kits.....	6
Matrix.....	Single Directional.....	199	Bench Type Calibration Kits for	
Precision and Standard Cable Assemblies.....			VNA Test Cables.....	7
Quick Reference Guide.....	<b>Detectors</b>		Calibration Kits Components.....	6
Selection Guide.....	Biased Detectors.....	214	Interchangeable Connectors.....	7
	Log Detectors.....	214		
<b>Coax Cables</b>	Zero Biased Detectors.....	213	<b>Tools</b>	
75 Ohm Broadcast.....			Cable Cutters.....	238
Communications.....	<b>Fiber Optics</b>		Crimp Tool Dies.....	240
High Performance.....	Adapters.....	235	Crimp Tools.....	239
RG Mil-C-17 type Cables.....	Attenuators.....	235	EMI-RFI Gasket for SMA Connectors.....	237
Semi-Rigid & Formable.....	Cable Assemblies.....	235	Field Replaceable Tab Contacts.....	237
Twinax.....	Cable Assemblies, Mode Conditioning.....	235	Hardware Miscellaneous.....	238
	Cable Assemblies, Optical Audio.....	235	Hermetic Seal Solder Contacts.....	237
<b>Connector Frequency Range Chart</b>	Loopbacks.....	235	Insertion/Extraction Tools.....	239
Connector Frequency Range Chart.....			Torque Wrenches.....	239
	<b>Limiters</b>			
<b>Connectors</b>	PIN-PIN.....	214	<b>Waveguides</b>	
Locator.....	PIN-Schottky.....	215	Grooved Flanges.....	232
Quick Reference Guide.....			High Power Terminations.....	234
Selection Guide.....	<b>Matching Pads</b>		Medium Power Terminations.....	233
1.0/2.3.....	Resistive Impedance Transformers.....	198	Precision Terminations.....	232
1.6/5.6, 75 Ohm.....			Standard Flanges.....	231
1.85mm.....	<b>Misc. RF Components</b>		Waveguide Terminations.....	233
10-32.....	Bandpass Filters.....	207		
2.4mm.....				
2.92mm.....				
3.5mm.....				
3/4"-20 Threaded Twinax.....				
7/16 DIN.....				
Banana Plug.....				
BNC, 50 Ohm.....				
BNC, 75 Ohm.....				
BNC Twinax.....				
C.....				

HELPFUL RESOURCES			
Cable Assemblies Matrix.....	10	REACH-RoHS Compliance Program.....	247
Adapters Matrix.....	138	How to Place your Order.....	249
Connector Identifier.....	242	Terms & Conditions.....	250
Mounting Hole Layout.....	246	Part Number Index.....	253

© 2012 Pasternack Enterprises, Inc. All Rights Reserved, Printed in USA

ROHS & REACH COMPLIANT. CUSTOM-LENGTH CABLE ASSEMBLIES MAY BE ORDERED ON OUR WEBSITE.

[www.pasternack.com](http://www.pasternack.com)

Toll-Free: 866-727-8376

Phone: 949-261-1920

Fax: 949-261-7451

# NEW PRODUCT ADDITIONS

## New Low PIM Products from Pasternack



### Low PIM Cable Assemblies

Pasternack Enterprises' new 1/2" coaxial jumpers are used on many RF communications applications that benefit from low PIM. Examples of these applications include tower top jumpers, shelter/cabinet jumpers, antenna feed lines and 2-way land mobile radio installations. The new 1/2" corrugated coax jumpers from Pasternack are perfect for runs when, low PIM, low VSWR, low insertion loss, and/or RF Isolation are critical. Our coaxial jumpers are 100% RF tested for PIM and VSWR, ensuring optimum installed performance.

**See Page 9 for Cable Assembly Products**

### Low PIM Connectors

The new low passive intermodulation (PIM) connectors from Pasternack are designed for ease of installation in the field while providing outstanding electrical and mechanical performance. These connectors are ideal for installations where custom length coaxial cable jumpers are needed to provide low PIM levels and outstanding RF performance. Pasternack's new lines of low PIM connectors are perfect for building custom assemblies using our low PIM coaxial cable jumpers.

**See Page 78 for Connector Products**

### Low PIM Adapters

The new low PIM adapters from Pasternack are perfect for applications requiring high performance at ultra low VSWR. Pasternack's new line of precision low PIM adapters is ideal for portable PIM testing and portable sweep testing. Other low PIM adapter applications include installations in cellular/PCS, RF wireless infrastructure, OEM in-rack RF routing, in-building systems, and land mobile radio. Pasternack's new lines of low PIM adapters mate perfectly to our low PIM coaxial cable jumpers.

**See Page 137 for Adapter Products**

## PRECISION CONNECTORS



Pasternack Enterprises' precision connectors are designed to fit onto 086 and 141 type semi-rigid and formable cable. These connectors are available in multiple connector types including SMA, N, TNC, MCX and MMCX type precision connectors. Frequency ratings for these RF connectors range from 6 GHz to 18 GHz depending on type and style.

**See Page 78 for Connectors**

See Our Website For Real-Time Stock Availability!



Free Freight Available  
via UPS Ground  
to USA & Canada



Real-Time Stock  
Levels & Pricing  
On Our WebSite



Toll-Free Technical  
Support  
(866) 727-8376



Same-Day Shipping,  
Even Custom  
Cable Assemblies



# NEW PRODUCT ADDITIONS

## HIGH FREQUENCY ATTENUATORS

Pasternack has recently added 1 Watt 2.4mm and 2.92mm attenuators with operating frequencies up to 50 GHz. These attenuators have stainless steel bodies with anti-torque flats to assist in the application of proper torque during mating of the connectors. The 40 GHz 2.92mm attenuators are available in 1 db increments from 1 to 10 db as well as 12, 15, 20 and 30 db attenuation values. The 50 GHz, 2.4mm version is available in the following attenuation values: 3, 6, 10, 15, 20 and 30 db.

**See Page 185 for Attenuator Products**



## HIGH FREQUENCY TERMINATIONS

Pasternack's new terminations (RF loads) include 1 Watt 40 and 50 GHz versions. They are available with 2.92mm and 2.4mm connector options with male and female interfaces. We have also added a 2 Watt 40 GHz termination with 2.92mm connectors. The Male versions of these terminations are available with and without retaining chains.

**See Page 195 for Termination Products**



## FILTERS

Pasternack introduces its new line of low pass and high pass filters to compliment our broad line of bandpass filters. Our filters cover a frequency range from 30 MHz to 5.9 GHz, and the Comblin design results in Low Insertion Loss performance. Suitable for the following bands:

- ISM
- RFID
- WiFi
- Bluetooth
- Zigbee
- GPS
- GSM
- PCS
- UMTS
- AWS
- WIMAX
- Military Communications

**See Page 207 for Filters**



Low Pass



High Pass

See Our Website For Real-Time Stock Availability!



# INDEX GUIDE TO TEST AND MEASUREMENT PRODUCTS

## TEST AND MEASUREMENT PRODUCTS.....6

### CALIBRATION KITS.....6



Pasternack offers Type N, 3.5mm and 3 Port Field Calibration Kits. Type N and 3.5mm standard Calibration Kits are designed for use with a broad range of vector network analyzers (VNAs) that utilize a Short-Open-Load calibration technique.

With Pasternack's Type N kit, you can make error-corrected measurements of devices supplied with Type N connectors from DC to 18 GHz. With our 3.5mm kit, you can make error-corrected measurements of devices supplied with either 3.5mm or SMA connectors from DC to 26.5 GHz. This kit contains both Male (Plug) and Female (Jack) connector interfaces to perform full Two-Port error corrections. The Pasternack 3-Port Field Calibration Tools are designed to make error-corrected measurements of devices supplied with 3.5mm, N-Type, or 7/16 DIN connectors.

Bench Type Calibration Kits.....6 3 Port Field Type Calibration Kits.....6

### CALIBRATION KITS MISCELLANEOUS.....6



Our calibration Open, Shorts, and Broadband Loads are available in 3.5mm and Type N connector types. These components are the same parts used in our PE5500-KIT and PE5501-KIT. Each Open, Short, and Broadband Load has a serial number and Calibration data is sent with each component.

Calibration Kits Components.....6

### VNA TEST CABLES.....7



Microwave test cables for Agilent® and Anritsu® VNA's and additional test equipment with 3.5mm NMD connector ports. These highly flexible test cables have excellent electrical characteristics with outstanding phase and amplitude stability. The unique interchangeable connector head can be configured for DUT applications that require Precision 7mm (PC-7), Type N, 3.5mm, SMA or 2.92mm connectors.

Bench Type Calibration Kits.....7 Interchangeable Connectors.....7





# CALIBRATION KITS

## Bench Type Calibration Kits



PE5500-KIT



PE5501-KIT

Type	Impedance	Connector Series	Polarity	Gender	Frequency Range (MHz)	Max. Power	Model No	1-24	25-49	50-99	100+	ROW
VNA Bench Type Kit	50 Ohm	3.5 mm	Standard	Male/ Female	DC - 26,500	0.5 Watt	PE5500-KIT	\$3,872.22	\$3,601.16	\$3,330.11	\$3,097.78	1
		N					PE5501-KIT	\$4,877.01	\$4,535.62	\$4,194.23	\$3,901.61	2

## 3 Port Field Type Calibration Kits

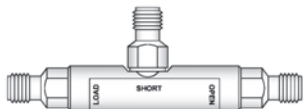

PE5510

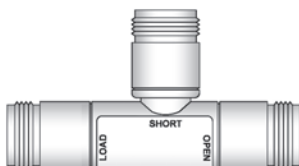

PE5512

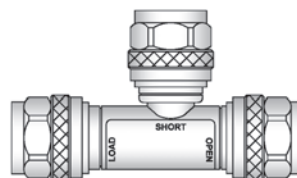

PE5513

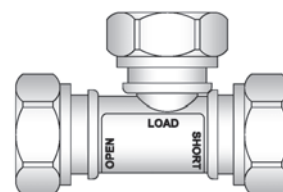

PE5515

Type	Impedance	Connector Series	Polarity	Gender	Frequency Range (MHz)	Max. Power	Model No	1-24	25-49	50-99	100+	ROW
3 Port Field Tool	50 Ohm	3.5 mm	Standard	Female	DC - 26,500	0.5 Watt	PE5510	\$1,070.30	\$995.38	\$920.46	\$856.24	3
				Male			PE5511	\$1,070.30	\$995.38	\$920.46	\$856.24	4
		N		Female			PE5512	\$670.40	\$623.47	\$576.54	\$536.32	5
				Male			PE5513	\$670.40	\$623.47	\$576.54	\$536.32	6
		7/16		Female			PE5514	\$783.13	\$728.31	\$673.49	\$626.50	7
				Male			PE5515	\$783.13	\$728.31	\$673.49	\$626.50	8

# CALIBRATION KITS MISCELLANEOUS

## Calibration Kits Components



PE5500-1



PE5500-2



PE5501-3

Type	Impedance	Connector Series	Polarity	Gender	Frequency Range (MHz)	Max. Power	Model No	1-24	25-49	50-99	100+	ROW
Open	50 Ohm	3.5 mm	Standard	Male	DC - 26,500	0.5 Watt	PE5500-1	\$588.68	\$547.47	\$506.26	\$470.94	9
				Female			PE5500-2	\$588.68	\$547.47	\$506.26	\$470.94	10
Short	50 Ohm	3.5 mm	Standard	Male	DC - 26,500	0.5 Watt	PE5500-3	\$588.68	\$547.47	\$506.26	\$470.94	11
				Female			PE5500-4	\$588.68	\$547.47	\$506.26	\$470.94	12
Open	50 Ohm	N	Standard	Male	DC - 18,000	0.5 Watt	PE5501-1	\$645.37	\$600.19	\$555.02	\$516.30	13
				Female			PE5501-2	\$645.37	\$600.19	\$555.02	\$516.30	14
Short	50 Ohm	N	Standard	Male	DC - 18,000	0.5 Watt	PE5501-3	\$591.56	\$550.15	\$508.74	\$473.25	15
				Female			PE5501-4	\$591.56	\$550.15	\$508.74	\$473.25	16

See Our Website For Real-Time Stock Availability!



# Calibration Kits Components



PE5500-5



PE5500-6



PE5501-6

Type	Impedance	Connector Series	Polarity	Gender	Frequency Range (MHz)	Max. Power	Model No	1-24	25-49	50-99	100+	ROW
Broadband Load	50 Ohm	3.5 mm	Standard	Male	DC - 26,500	0.5 Watt	PE5500-5	\$1,560.08	\$1,450.87	\$1,341.67	\$1,248.06	17
		N		Female			PE5500-6	\$1,560.08	\$1,450.87	\$1,341.67	\$1,248.06	18
				N	Male		DC - 18,000	PE5501-5	\$1,290.74	\$1,200.39	\$1,110.04	\$1,032.59
		Female			PE5501-6		\$1,290.74	\$1,200.39	\$1,110.04	\$1,032.59	20	

# VNA TEST CABLES

## Bench Type Calibration Kits



PE310-KIT

Type	Impedance	Connector Series	Polarity	Gender	Frequency Range (MHz)	Max. Power	Model No	1-24	25-49	50-99	100+	ROW
Cable for Interchangeable Connectors	50 Ohm	3.5mm NMD	Standard	Interchangeable	DC - 26,500	0.5 Watt	PE310-KIT	\$4,229.97	\$3,933.87	\$3,637.77	\$3,383.98	21

## Interchangeable Connectors

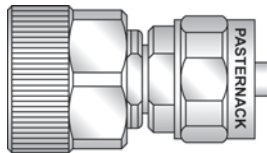

PE44484

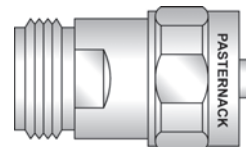

PE44486

Type	Impedance	Connector Series	Polarity	Gender	Frequency Range (MHz)	Max. Power	Model No	1-24	25-49	50-99	100+	ROW	
Connector	50 Ohm	7 mm	Standard	Male	DC - 26,500	0.5 Watt	PE44484	\$311.89	\$290.06	\$268.23	\$249.51	22	
		N		Female			PE44485	\$311.89	\$290.06	\$268.23	\$249.51	23	
				3.5mm			Male	PE44486	\$311.89	\$290.06	\$268.23	\$249.51	24
		Female					PE44487	\$311.89	\$290.06	\$268.23	\$249.51	25	
		3.5mm					Male	PE44488	\$311.89	\$290.06	\$268.23	\$249.51	26
							Female	PE44488	\$311.89	\$290.06	\$268.23	\$249.51	26

Eric E. Winston invented the F connector in the early 1950's.

Test and Measurement

See Our Website For Real-Time Stock Availability!



Free Freight Available via UPS Ground to USA & Canada



Real-Time Stock Levels & Pricing On Our WebSite



Toll-Free Technical Support (866) 727-8376



Same-Day Shipping, Even Custom Cable Assemblies



# CONNECTOR FREQUENCY RANGE CHART

Test and Measurement

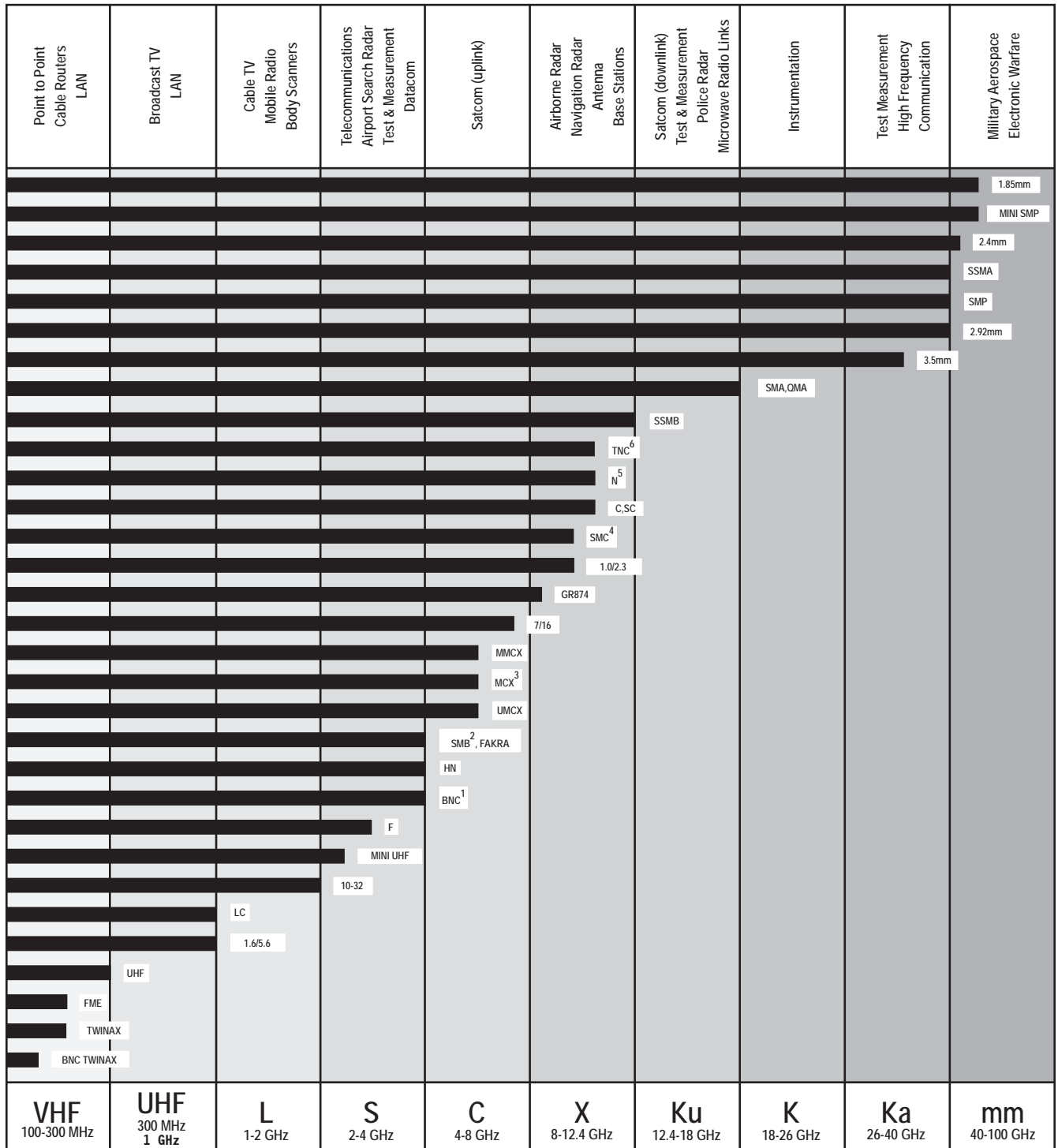

**Notes:**

- 1: BNC-75 Ohm connectors operate up to 1 GHz
- 2: SMB-75 Ohm & Mini SMB-75 Ohm connectors operate up to 4 GHz
- 3: MCX-75 Ohm connectors operate up to 6 GHz
- 4: SMC-75 Ohm connectors operate up to 10 GHz
- 5: N-75 Ohm connectors operate up to 1.5 GHz
- 6: TNC-75 Ohm connectors operate up to 1 GHz

See Our Website For Real-Time Stock Availability!



# Coaxial Cable Assemblies Selection Guide

Do you need a cable assembly that isn't in our catalog?  
 Visit our website to view our entire selection of available assemblies or  
 to build your own custom length cable assembly!

## 3 Easy Ways to Find your Product.....

### 1. Search by PE Part Number

If you know the PE part number you are searching for, please reference our Part Number Index on Page 253.

### 2. Quick Reference Guide

See pages 10-11 for our **Cable Assemblies Matrix**.

(Page number refers to first appearance of product in the Cable Assemblies Section)

Cable Connector	Page	Cable Connector	Page	Cable Connector	Page	Cable Connector	Page	Cable Connector	Page
<b>Precision Cable Assembly</b>		2.92mm	45	HN	58	QN	51	SMC-50 Ohm	39
1.85mm	23	3.5mm	45	LC	58	RCA-75 Ohm	71	SMC-75 Ohm	70
2.4mm	23	3/4"-20 Twinax	73	MC-Card	41	Reverse Polarity SMA	34	SMP	39
2.92mm	17	7/16 DIN	50	MCX	44	Reverse Polarity TNC	39	SSMA	36
3.5mm	16	Alligator Clips	67	MHV	68	Reverse Thread SMA	45	SSMB	59
MCX	25	Banana Plug	67	Miniature Alligator Clips	67	Safety Hooks	68	Tip Plugs	68
MMCX	25	BNC-50 Ohm	41	Miniature Banana Plugs	68	SC	58	Standard Banana Plugs	67
N	15	BNC-75 Ohm	69	Mini SMB-75 Ohm	71	SHV	68	TNC-50 Ohm	38
SMA	15	BNC Twinax	73	Mini UHF	51	Single Wire Patch Cords	73	TNC-75 Ohm	69
TNC	15	Breakouts	76	MMCX	40	SMA	30	UHF	55
<b>Standard Cable Assembly</b>		C	69	N-50 Ohm	36	SMB-50 Ohm	40	UMCX	39
1.85mm	45	FAKRA	40	N-75 Ohm	69	SMB-75 Ohm	71	Unterminated Wires	68
10-32	57	FME	56	QMA	39				
2.4mm	36	GR874	64						

### 3. Cable Assembly Locator

(Cable Assembly Locator on Page 12-13 to locate the Cable Assembly you need by either connector end.)



SMA Female Bulkhead to MCX Plug Right Angle  
 PE39421-12

SMA FEMALE BULKHEAD TO:	EXAMPLE
<b>MCX PLUG RIGHT ANGLE</b> .....	<b>23</b>
MMCX PLUG RIGHT ANGLE .....	23
SMA FEMALE BULKHEAD .....	43
SMA MALE .....	17,23,31,32
SMA MALE RIGHT ANGLE .....	17,23,40,41
UMCX PLUG .....	76

MCX PLUG RIGHT ANGLE TO:	EXAMPLE
MCX PLUG .....	78
MCX PLUG RIGHT ANGLE .....	79
N FEMALE BULKHEAD .....	25
<b>SMA FEMALE BULKHEAD</b> .....	<b>23</b>
TNC FEMALE BULKHEAD .....	27
UMCX PLUG .....	76

The Cable Assembly Locator example above includes Between-Series Cable Assembly part numbers in two configurations:  
**Connector 1 to Connector 2 as well as Connector 2 to Connector 1 will be found in the same location.**

Products can only be found under the first instance of the series combination. As an example, PE39421-12 above will be found in only one location in the Cable Assembly Section.

All Pasternack coaxial cable assembly part number indicate the length of the assembly (in inches) following the hyphen.  
 Example: PE300-24 and PE300-26.5 are 24 inches and 26.5 inches in length respectively

**NOTE:** All cable assemblies have a length tolerance of 1.5% or  $\pm 3/8"$ , whichever is greater.



# Cable Assemblies Matrix

Additional configurations can be found on our website.

Cable Assemblies

Connectors	1.65.6 75 Ohm	1.85mm	1032	2.4mm	2.92mm	3.5mm	3.5mm NMD	3/4"- 20	7/16 DIN	Alligator	Banana	BNC 75 Ohm	BNC	BNC Twinax	C	F 75 Ohm	FAKRA	FC (FO)	FME	GR874	HDMI 75 Ohm	HN	Hook	LC (FO)	LC	MCCard	MCX	MHV	Mini Alligator	Mini Banana	Mini SMB 75 Ohm
1.65.6 75 Ohm	W											71	W																		
1.85mm		46		46	45	W																									
1032			57										57																		
2.4mm		46		45	45																										
2.92mm		45		45	45																										
3.5mm		W				45																									
3.5mm NMD																															
3/4"- 20								73																							
7/16 DIN									55																						
Alligator										74	73	67																			
Banana										73	73	67																	74		
BNC 75 Ohm	71											72				70															71
BNC	W		57							67	67	64			W				56	64			68					67	68	W	
BNC Twinax														73																	
C															69																
F 75 Ohm											70	W			70																
FAKRA																	63														
FC (FO)																															
FME													56						56												
GR874													64								64										
HDMI 75 Ohm																						W									
HN																							58								
Hook												68																			
LC (FO)																															
LC																									58						
MCCard																											W				
MCX																												60			
MHV																													68		
Mini Alligator											74	67																	75		
Mini Banana												68																			
Mini SMB 75 Ohm											71	W																			71
Mini UHF																															
MMCX													60																		
MTRJ (FO)																															
N 75 Ohm												69																			
N								50				51									W							52			
NMO Mount													68						56												
Open																															
QMA																															
QN																															
RCA 75 Ohm																															
SC (FO)																															
SC																															
SHV																														68	
SMA		W		36					W			41				40											41	44			
SMB 75 Ohm												71																			
SMB													62																		
SMC 75 Ohm												70																			
SMC													57																		
SMP																															
Spade										74	74																				
SSMA																															
SSMB																															
ST (FO)																															
Tip														68																	
TNC 75 Ohm												69																			
TNC													54															54			
TOSLINK																															
UHF											W	55																			
UMCX																			56									59			
Unterminated Lead													68																		
VF45 (FO)																															

W = See Website

ROHS & REACH COMPLIANT. CUSTOM-LENGTH CABLE ASSEMBLIES MAY BE ORDERED ON OUR WEBSITE.

Visit Our Website for More Information. We Build Custom Cables.  
Notes: Cable assembly max frequency may be lower than connector or coax max frequency

# Cable Assemblies Matrix

Additional configurations can be found on our website.

Connectors	Mini UHF	MMCX	MTRJ (FO)	N 75 Ohm	N	NMO Mount	Open	QMA	QN	RCA 75 Ohm	SC (FO)	SC	SHV	SMA	SMB 75 Ohm	SMB	SMC 75 Ohm	SMC	SMP	Spade	SSMA	SSMB	ST (FO)	Tip	TNC 75 Ohm	TNC	TOSLINK	UHF	UMCX	Unterminated Lead	VF45 (FO)
1.65.6 75 Ohm																															
1.85mm														W																	
1032																															
2.4mm														36																	
2.92mm																															
3.5mm																															
3.5mm NMD																															
3/4" - 20																															
7/16 DIN					50									W																	
Alligator																					74										
Banana																					74								W		
BNC 75 Ohm				69											71		70									69					
BNC		60			51	68								41		62		57							68		54		55		68
BNC Twinax																															
C																															
F 75 Ohm																															
FAKRA														40																	
FC (FO)																															
FME						56																								56	
GR874					W																										
HDMI 75 Ohm																															
HN																															
Hook																															
LC (FO)																															
LC																															
MCCard															41																
MCX					52										44											54			59		
MHV													68																		
Mini Alligator																															
Mini Banana																															
Mini SMB 75 Ohm																															
Mini UHF	56				51	W								W																	
MMCX		59			52										40											54			59		
MTRJ (FO)																															
N 75 Ohm				69																											
N	51	52			46	52			51					36												50		W	51		
NMO Mount	W				52									42												W					
Open																														59	
QMA									58						39																
QN					51				58																						
RCA 75 Ohm										71																					
SC (FO)																															
SC													58																		
SHV														69																	
SMA	W	40			36	42		39						30		40		39	39								38			39	
SMB 75 Ohm															71																
SMB														40		61															
SMC 75 Ohm																		70													
SMC														39					56								W			57	
SMP														39							58										
Spade																															
SSMA														36									46								
SSMB																								63						59	
ST (FO)																															
Tip																															
TNC 75 Ohm																										69					
TNC		54			50	W								38						W							52			54	
TOSLINK																															
UHF					W																									55	
UMCX		59			51		59							39												54				59	
Unterminated Lead																															
VF45 (FO)																															

W = See Website

Cable Assemblies

Visit Our Website for More Information. We Build Custom Cables.  
Notes: Cable assembly max frequency may be lower than connector or coax max frequency

 Free Freight Available via UPS Ground to USA & Canada

 Real-Time Stock Levels & Pricing On Our WebSite

 Toll-Free Technical Support (866) 727-8376

 Same-Day Shipping, Even Custom Cable Assemblies



# Cable Assembly Locator

Connector Type	Page
<b>1.85mm MALE</b>	
1.85mm MALE.....	23, 46
2.4mm MALE.....	23, 46
2.92mm MALE.....	23, 45
<b>10-32 MALE</b>	
10-32 MALE.....	57
10-32 MALE RIGHT ANGLE.....	57
BNC MALE.....	57
<b>10-32 MALE RIGHT ANGLE</b>	
10-32 MALE.....	57
<b>2.4mm FEMALE</b>	
2.4mm MALE.....	46
<b>2.4mm MALE</b>	
1.85mm MALE.....	23, 46
2.4mm FEMALE.....	46
2.4mm MALE.....	23, 45
2.92mm MALE.....	23, 45
SMA MALE.....	36
<b>2.92mm FEMALE</b>	
2.92mm MALE.....	45
<b>2.92mm FEMALE BULKHEAD</b>	
2.92mm MALE.....	45
<b>2.92mm MALE</b>	
1.85mm MALE.....	23, 45
2.4mm MALE.....	23, 45
2.92mm FEMALE.....	45
2.92mm FEMALE BULKHEAD.....	45
2.92mm MALE.....	17, 23, 45
2.92mm FEMALE.....	17
<b>2.92mm FEMALE</b>	
2.92mm MALE.....	17
<b>3.5mm FEMALE</b>	
3.5mm MALE.....	16, 45
<b>3.5mm FEMALE</b>	
3.5mm MALE.....	45
<b>3.5mm MALE</b>	
3.5mm FEMALE.....	16, 45
3.5mm FEMALE.....	45
3.5mm MALE.....	16, 45
<b>3/4" - 20 MALE</b>	
3/4"-20 MALE.....	73
<b>7/16 DIN FEMALE</b>	
7/16 DIN MALE.....	55
<b>7/16 DIN MALE</b>	
7/16 DIN FEMALE.....	55
7/16 DIN MALE.....	55
7/16 DIN MALE RIGHT ANGLE.....	55
N MALE.....	50
<b>7/16 DIN MALE RIGHT ANGLE</b>	
7/16 DIN MALE.....	55
<b>75 OHM 1.6/5.6 PLUG</b>	
75 OHM BNC MALE.....	71
<b>75 OHM BNC FEMALE</b>	
75 OHM BNC FEMALE.....	73
75 OHM BNC MALE.....	72
<b>75 OHM BNC FEMALE BULKHEAD</b>	
75 OHM BNC MALE.....	72
<b>75 OHM BNC MALE</b>	
75 OHM 1.6/5.6 PLUG.....	71
75 OHM BNC FEMALE.....	72
75 OHM BNC FEMALE BULKHEAD.....	72
75 OHM BNC MALE.....	72
75 OHM BNC MALE RIGHT ANGLE.....	72
75 OHM F MALE.....	70
75 OHM MINI SMB PLUG.....	71
75 OHM N MALE.....	69
75 OHM SMB PLUG.....	71
75 OHM SMC PLUG.....	70
75 OHM TNC MALE.....	69

Connector Type	Page
<b>75 OHM BNC MALE RIGHT ANGLE</b>	
75 OHM BNC MALE.....	72
75 OHM BNC MALE RIGHT ANGLE.....	73
<b>75 OHM F MALE</b>	
75 OHM BNC MALE.....	70
75 OHM F MALE.....	70
75 OHM F MALE RIGHT ANGLE.....	70
<b>75 OHM F MALE RIGHT ANGLE</b>	
75 OHM F MALE.....	70
<b>75 OHM MCX JACK</b>	
N FEMALE BULKHEAD.....	52
SMA FEMALE BULKHEAD.....	44
TNC FEMALE BULKHEAD.....	54
<b>75 OHM MCX PLUG</b>	
UMCX PLUG.....	59
<b>75 OHM MINI SMB PLUG</b>	
75 OHM BNC MALE.....	71
75 OHM MINI SMB PLUG.....	71
75 OHM MINI SMB PLUG RIGHT ANGLE.....	71
<b>75 OHM MINI SMB PLUG RIGHT ANGLE</b>	
75 OHM MINI SMB PLUG.....	71
75 OHM MINI SMB PLUG RIGHT ANGLE.....	71
<b>75 OHM N MALE</b>	
75 OHM BNC MALE.....	69
75 OHM N MALE.....	69
<b>75 OHM RCA FEMALE BULKHEAD</b>	
75 OHM RCAMALE.....	71
<b>75 OHM RCA MALE</b>	
75 OHM RCA FEMALE BULKHEAD.....	71
<b>75 OHM SMB PLUG</b>	
75 OHM BNC MALE.....	71
75 OHM SMB PLUG.....	71
<b>75 OHM SMC PLUG</b>	
75 OHM BNC MALE.....	70
75 OHM SMC PLUG.....	70
<b>75 OHM TNC MALE</b>	
75 OHM BNC MALE.....	69
75 OHM TNC MALE.....	69
<b>ALLIGATOR CLIP</b>	
ALLIGATOR CLIP.....	74
BANANA PLUG.....	73
BNC MALE.....	67
SPADE LUG.....	74
<b>BANANA PLUG</b>	
ALLIGATOR CLIP.....	73
BANANA PLUG.....	73
BNC MALE.....	67
MINI ALLIGATOR CLIP.....	74
SPADE LUG.....	74
<b>BNC FEMALE</b>	
BNC FEMALE.....	67
BNC MALE.....	66
NMO MOUNT CONNECTOR.....	68
<b>BNC FEMALE BULKHEAD</b>	
BNC MALE.....	66
MMCX PLUG RIGHT ANGLE.....	60
<b>BNC MALE</b>	
10-32 MALE.....	57
ALLIGATOR CLIP.....	67
BANANA PLUG.....	67
BNC FEMALE.....	66
BNC FEMALE BULKHEAD.....	66
BNC MALE.....	64
BNC MALE RIGHT ANGLE.....	65
FME JACK.....	56
GR874.....	64
HOOK.....	68
MINI ALLIGATOR CLIP.....	67
MINI BANANA PLUG.....	68
N MALE.....	51
NMO MOUNT CONNECTOR.....	68

Connector Type	Page
REVERSE POLARITY SMA MALE.....	44
REVERSE POLARITY TNC MALE.....	54
SMA MALE.....	41
SMA MALE RIGHT ANGLE.....	42
SMB PLUG.....	62
SMC PLUG.....	57
TIP PLUG.....	68
TNC MALE.....	54
UHF MALE.....	55
UNTERMINATED LEAD.....	68
<b>BNC MALE RIGHT ANGLE</b>	
BNC MALE.....	65
BNC MALE RIGHT ANGLE.....	66
<b>BNC TWINAX PLUG</b>	
BNC TWINAX PLUG.....	73
<b>BREAKOUTS</b>	
BREAKOUTS.....	76
<b>C MALE</b>	
C MALE.....	69
<b>FAKRA JACK</b>	
FAKRA JACK.....	64
FAKRA PLUG.....	63
SMA FEMALE.....	43
SMA MALE.....	41
<b>FAKRA JACK RIGHT ANGLE</b>	
FAKRA PLUG.....	64
<b>FAKRA PLUG</b>	
FAKRA JACK.....	63
FAKRA JACK RIGHT ANGLE.....	64
FAKRA PLUG.....	63
SMA FEMALE.....	43
SMA MALE.....	40
<b>FME JACK</b>	
BNC MALE.....	56
FME JACK.....	56
NMO MOUNT CONNECTOR.....	56
<b>FME JACK BULKHEAD</b>	
UMCX PLUG.....	56
<b>FME PLUG</b>	
NMO MOUNT CONNECTOR.....	56
<b>GR874</b>	
BNC MALE.....	64
GR874.....	64
<b>HN MALE</b>	
HN MALE.....	58
<b>HOOK</b>	
BNC MALE.....	68
<b>LC MALE</b>	
LC MALE.....	58
<b>MC-CARD PLUG</b>	
SMA MALE.....	41
<b>MCX JACK BULKHEAD</b>	
UMCX PLUG RIGHT ANGLE.....	59
<b>MCX PLUG</b>	
MCX PLUG.....	60
MCX PLUG RIGHT ANGLE.....	60
UMCX PLUG RIGHT ANGLE.....	59
<b>MCX PLUG RIGHT ANGLE</b>	
MCX PLUG.....	60
MCX PLUG RIGHT ANGLE.....	60
TNC FEMALE BULKHEAD.....	29, 54
UMCX PLUG RIGHT ANGLE.....	59
<b>MCX PLUG RIGHT ANGLE</b>	
N FEMALE BULKHEAD.....	27, 52
SMA FEMALE BULKHEAD.....	25, 44
TNC FEMALE BULKHEAD.....	29, 54
<b>MHV MALE</b>	
MHV MALE.....	68
SHV PLUG.....	68

Connector Type	Page
<b>MINI ALLIGATOR CLIP</b>	
BANANA PLUG.....	74
BNC MALE.....	67
MINI ALLIGATOR CLIP.....	75
<b>MINI BANANA PLUG</b>	
BNC MALE.....	68
<b>MINI UHF MALE</b>	
MINI UHF MALE.....	56
N MALE.....	51
<b>MMCX PLUG</b>	
MMCX PLUG.....	59
MMCX PLUG RIGHT ANGLE.....	60
N FEMALE BULKHEAD.....	27, 52
SMA FEMALE BULKHEAD.....	44
SMA MALE.....	40
<b>MMCX PLUG RIGHT ANGLE</b>	
BNC FEMALE BULKHEAD.....	60
MMCX PLUG.....	60
SMA FEMALE BULKHEAD.....	44
SMA MALE.....	40
TNC FEMALE BULKHEAD.....	29, 54
UMCX PLUG RIGHT ANGLE.....	59
<b>MMCX PLUG RIGHT ANGLE</b>	
N FEMALE BULKHEAD.....	27, 52
SMA FEMALE BULKHEAD.....	25, 44
TNC FEMALE BULKHEAD.....	29, 54
<b>N FEMALE</b>	
N MALE.....	27, 48
NMO MOUNT CONNECTOR.....	52
ON MALE.....	52
ON MALE RIGHT ANGLE.....	52
<b>N FEMALE BULKHEAD</b>	
N MALE.....	19, 21, 48
SMA MALE.....	19, 21, 27, 37
<b>N FEMALE BULKHEAD</b>	
75 OHM MCX JACK.....	52
MMCX PLUG.....	27, 52
N MALE.....	48
N MALE RIGHT ANGLE.....	49
SMA MALE.....	37
SMA MALE RIGHT ANGLE.....	42
<b>N FEMALE BULKHEAD</b>	
MCX PLUG RIGHT ANGLE.....	27, 52
MMCX PLUG RIGHT ANGLE.....	27, 52
N MALE.....	15
SMA MALE.....	19, 21, 27, 37
SMA MALE RIGHT ANGLE.....	27, 42
<b>N MALE</b>	
7/16 DIN MALE.....	50
BNC MALE.....	51
MINI UHF MALE.....	51
N FEMALE.....	27, 48
N FEMALE BULKHEAD.....	19, 21, 48
N FEMALE BULKHEAD.....	48
N FEMALE BULKHEAD.....	15
N MALE.....	15, 19, 21, 26, 46
N MALE RIGHT ANGLE.....	15, 27, 47
N MALE RIGHT ANGLE.....	15
NMO MOUNT CONNECTOR.....	52
ON MALE.....	51
ON MALE RIGHT ANGLE.....	51
REVERSE POLARITY SMA MALE.....	44
REVERSE POLARITY TNC MALE.....	50
SMA FEMALE.....	15, 43
SMA MALE.....	15, 19, 21, 36
TNC MALE.....	50
UMCX PLUG RIGHT ANGLE.....	51
<b>N MALE RIGHT ANGLE</b>	
N FEMALE BULKHEAD.....	49
N MALE.....	15, 27, 47
N MALE RIGHT ANGLE.....	49

# Cable Assembly Locator

Connector Type	Page
<b>N MALE RIGHT ANGLE</b>	
N MALE .....	15
N MALE RIGHT ANGLE .....	15, 27
<b>NMO MOUNT CONNECTOR</b>	
BNC FEMALE .....	68
BNC MALE .....	68
FME JACK .....	56
FME PLUG .....	56
N FEMALE .....	52
N MALE .....	52
SMA FEMALE .....	43
SMA MALE .....	42
<b>OPEN</b>	
UMCX PLUG RIGHT ANGLE .....	59
<b>PUSH ON SMA MALE</b>	
SMA MALE .....	15, 31
<b>QD SMA MALE</b>	
SMA MALE .....	15, 31
<b>QMA MALE</b>	
QMA MALE .....	58
SMA FEMALE .....	43
SMA MALE .....	39
<b>QN MALE</b>	
N FEMALE .....	52
N MALE .....	51
QN MALE .....	58
<b>QN MALE RIGHT ANGLE</b>	
N FEMALE .....	52
N MALE .....	51
<b>REVERSE POLARITY MCX JACK BULKHEAD</b>	
UMCX PLUG RIGHT ANGLE .....	59
<b>REVERSE POLARITY SMA FEMALE BULKHEAD</b>	
UMCX PLUG RIGHT ANGLE .....	45
<b>REVERSE POLARITY SMA MALE</b>	
BNC MALE .....	44
N MALE .....	44
SMA MALE .....	34
TNC MALE .....	44
<b>REVERSE POLARITY TNC FEMALE BULKHEAD</b>	
UMCX PLUG RIGHT ANGLE .....	55
<b>REVERSE POLARITY TNC MALE</b>	
BNC MALE .....	54
N MALE .....	50
SMA MALE .....	39
TNC MALE .....	53
<b>REVERSE THREAD SMA FEMALE BULKHEAD</b>	
UMCX PLUG RIGHT ANGLE .....	45
<b>SC MALE</b>	
SC MALE .....	58
<b>SHV PLUG</b>	
MHV MALE .....	68
SHV PLUG .....	69
<b>SMA FEMALE</b>	
FAKRA JACK .....	43
FAKRA PLUG .....	43
N MALE .....	15, 43
NMO MOUNT CONNECTOR .....	43
QMA MALE .....	43
SMA FEMALE .....	35
SMA MALE .....	25, 32
<b>SMA FEMALE 2 HOLE PANEL</b>	
SMA FEMALE 2 HOLE PANEL .....	36
<b>SMA FEMALE 4 HOLE PANEL</b>	
SMA FEMALE 4 HOLE PANEL .....	36
<b>SMA FEMALE BULKHEAD</b>	
75 OHM MCX JACK .....	44
MMCX PLUG .....	44

Connector Type	Page
<b>MMCX PLUG RIGHT ANGLE</b>	44
SMA FEMALE BULKHEAD .....	36
SMA MALE .....	19, 25, 33
SMA MALE RIGHT ANGLE .....	35
UMCX PLUG .....	43
UMCX PLUG RIGHT ANGLE .....	44
<b>SMA FEMALE BULKHEAD</b>	
MCX PLUG RIGHT ANGLE .....	25, 44
MMCX PLUG RIGHT ANGLE .....	25, 44
SMA MALE .....	19
SMA MALE RIGHT ANGLE .....	19, 25, 35
<b>SMA MALE</b>	
2.4mm MALE .....	36
BNC MALE .....	41
FAKRA JACK .....	41
FAKRA PLUG .....	40
MC-CARD PLUG .....	41
MMCX PLUG .....	40
MMCX PLUG RIGHT ANGLE .....	40
N FEMALE BULKHEAD .....	19, 21, 27, 37
N FEMALE BULKHEAD .....	37
N FEMALE BULKHEAD .....	19, 21, 27, 37
N MALE .....	15, 19, 21, 36
NMO MOUNT CONNECTOR .....	42
PUSH ON SMA MALE .....	15, 31
QD SMA MALE .....	15, 31
QMA MALE .....	39
REVERSE POLARITY SMA MALE .....	34
REVERSE POLARITY TNC MALE .....	39
SMA FEMALE .....	25, 32
SMA FEMALE BULKHEAD .....	19, 25, 33
SMA FEMALE BULKHEAD .....	19
SMA MALE .....	15, 21, 24, 30
SMA MALE PUSH-ON .....	15, 31
SMA MALE OD .....	15, 31
SMA MALE RIGHT ANGLE .....	15, 19, 21, 25, 31
SMA MALE RIGHT ANGLE .....	15
SMB PLUG .....	40
SMC PLUG .....	39
SMP FEMALE .....	39
SSMA MALE .....	36
TNC FEMALE BULKHEAD .....	39
TNC FEMALE BULKHEAD .....	29, 39
TNC MALE .....	15, 19, 38
TNC MALE RIGHT ANGLE .....	15, 39
TNC MALE RIGHT ANGLE .....	15
UMCX PLUG RIGHT ANGLE .....	39
<b>SMA MALE PUSH-ON</b>	
SMA MALE .....	15, 31
<b>SMA MALE QD</b>	
SMA MALE .....	15, 31
<b>SMA MALE RIGHT ANGLE</b>	
BNC MALE .....	42
N FEMALE BULKHEAD .....	42
SMA FEMALE BULKHEAD .....	35
SMA MALE .....	15, 19, 21, 25, 31
SMA MALE RIGHT ANGLE .....	34
TNC FEMALE BULKHEAD .....	42
<b>SMA MALE RIGHT ANGLE</b>	
N FEMALE BULKHEAD .....	27, 42
SMA FEMALE BULKHEAD .....	19, 25, 35
SMA MALE .....	15
SMA MALE RIGHT ANGLE .....	19, 21, 25, 34
TNC FEMALE BULKHEAD .....	29, 42
<b>SMB JACK BULKHEAD</b>	
SMB PLUG .....	61
SMB PLUG RIGHT ANGLE .....	62
<b>SMB PLUG</b>	
BNC MALE .....	62
SMA MALE .....	40
SMB JACK BULKHEAD .....	61
SMB PLUG .....	61
SMB PLUG RIGHT ANGLE .....	61
<b>SMB PLUG RIGHT ANGLE</b>	
SMB JACK BULKHEAD .....	62

Connector Type	Page
<b>SMB PLUG</b>	61
SMB PLUG RIGHT ANGLE .....	62
<b>SMC JACK BULKHEAD</b>	
SMC PLUG .....	57
SMC PLUG RIGHT ANGLE .....	57
UMCX PLUG RIGHT ANGLE .....	57
<b>SMC PLUG</b>	
BNC MALE .....	57
SMA MALE .....	39
SMC JACK BULKHEAD .....	57
SMC PLUG .....	56
SMC PLUG RIGHT ANGLE .....	56
<b>SMC PLUG RIGHT ANGLE</b>	
SMC JACK BULKHEAD .....	57
SMC PLUG .....	56
SMC PLUG RIGHT ANGLE .....	57
<b>SMP FEMALE</b>	
SMA MALE .....	39
SMP FEMALE .....	58
SMP FEMALE RIGHT ANGLE .....	58
<b>SMP FEMALE RIGHT ANGLE</b>	
SMP FEMALE .....	58
<b>SPADE LUG</b>	
ALLIGATOR CLIP .....	74
BANANA PLUG .....	74
<b>SSMA MALE</b>	
SMA MALE .....	36
SSMA MALE .....	46
<b>SSMB PLUG</b>	
UMCX PLUG RIGHT ANGLE .....	59
<b>SSMB PLUG RIGHT ANGLE</b>	
SSMB PLUG RIGHT ANGLE .....	63
<b>TIP PLUG</b>	
BNC MALE .....	68
<b>TNC FEMALE</b>	
TNC MALE .....	29, 53
<b>TNC FEMALE BULKHEAD</b>	
75 OHM MCX JACK .....	54
MCX PLUG RIGHT ANGLE .....	29, 54
MMCX PLUG RIGHT ANGLE .....	29, 54
SMA MALE .....	39
SMA MALE RIGHT ANGLE .....	42
UMCX PLUG RIGHT ANGLE .....	54
<b>TNC FEMALE BULKHEAD</b>	
MCX PLUG RIGHT ANGLE .....	29, 54
MMCX PLUG RIGHT ANGLE .....	29, 54
SMA MALE .....	29, 39
SMA MALE RIGHT ANGLE .....	29, 42
<b>TNC MALE</b>	
BNC MALE .....	54
N MALE .....	50
REVERSE POLARITY SMA MALE .....	44
REVERSE POLARITY TNC MALE .....	53
SMA MALE .....	15, 19, 38
TNC FEMALE .....	29, 53
TNC MALE .....	19, 28, 52
TNC MALE RIGHT ANGLE .....	29, 53
TNC MALE RIGHT ANGLE .....	29
<b>TNC MALE RIGHT ANGLE</b>	
SMA MALE .....	15, 39
TNC MALE .....	29, 53
TNC MALE RIGHT ANGLE .....	53
<b>TNC MALE RIGHT ANGLE</b>	
SMA MALE .....	15
TNC MALE .....	29
TNC MALE RIGHT ANGLE .....	29, 53
<b>UHF MALE</b>	
BNC MALE .....	55
UHF MALE .....	55

Connector Type	Page
<b>UMCX PLUG</b>	
75 OHM MCX PLUG .....	59
FME JACK BULKHEAD .....	56
SMA FEMALE BULKHEAD .....	43
UMCX PLUG .....	59
<b>UMCX PLUG RIGHT ANGLE</b>	
MCX JACK BULKHEAD .....	59
MCX PLUG .....	59
MCX PLUG RIGHT ANGLE .....	59
MMCX PLUG RIGHT ANGLE .....	59
N MALE .....	51
OPEN .....	59
REVERSE POLARITY MCX JACK BULKHEAD .....	59
REVERSE POLARITY SMA FEMALE BULKHEAD .....	45
REVERSE POLARITY TNC FEMALE BULKHEAD .....	55
REVERSE THREAD SMA FEMALE BULKHEAD .....	45
SMA FEMALE BULKHEAD .....	44
SMA MALE .....	39
SMC JACK BULKHEAD .....	57
SSMB PLUG .....	59
TNC FEMALE BULKHEAD .....	54
<b>UNTERMINATED LEAD</b>	
BNC MALE .....	68
<b>BREAKOUTS</b>	
BREAKOUTS .....	76

**Microwaves are classified as wavelengths ranging between one millimeter and one meter.**





# 18 GHZ TEST CABLE ASSEMBLIES

## Product Features

- Stainless Steel Connectors
- Reinforced Connector Back Shell
- Molded Strain Relief Boot
- Triple Shield Cable
- RoHS Compliant

## Description

The 18 GHz test cable series offers a reinforced cable/connector interface with a molded, heavy-duty strain relief boot to minimize interface stress in demanding test environments. Its triple-shield cable design ensures excellent RF shielding of >100dB. The Right Angle connector designs utilize a swept coaxial transition for improved high frequency performance.

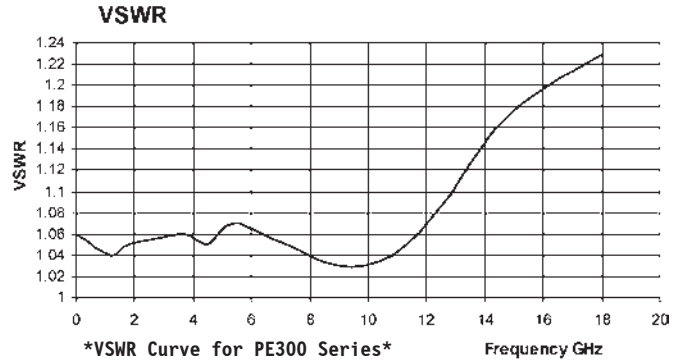
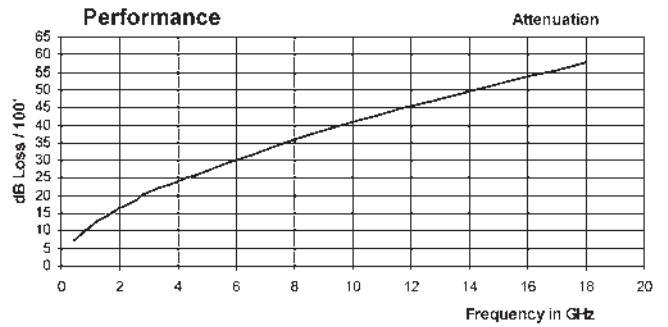

## Electrical Specifications <sup>(1)</sup>

Parameter	Units	Value	Description
Impedance	Ohms	50Ω	
Frequency	GHz	18	
*Maximum VSWR	GHz	DC-2, 2-8, 8-18	DC-2 GHz, 1:06:1 / 2-8 GHz, 1.09:1 / 8-18 GHz, 1.4:1
Insertion Loss (Typ.)	dB/100ft	58	58 dB per 100 ft @ 18 GHz
Max Operating Voltage	V	1000	RMS
Nominal Capacitance	pF / ft.	29.4	
Velocity of Propagation	%	70	
RF Shielding	dB	<-110	Triple shield design

\*See Website for detailed VSWR Specifications for each PE Part Number.

## Mechanical Specifications <sup>(1)</sup>

Parameter	Units	Value	Description
Connector A		Stainless Steel	N, SMA, TNC
Connector B		Stainless Steel	N, SMA, TNC
Minimum Bend Radius	in. [cm]	0.75 [1.91]	
Operating Temperature	C	-55° to +125°	
Inner Conductor Diameter	in. [cm]	0.037 [.09]	Solid Silver plated Cu Clad Steel
Dielectric Diameter	in. [cm]	0.117 [.29]	Solid PTFE
Jacket Diameter	in. [cm]	0.163 [.41]	FEP

(1) Pasternack reserves the right to change specifications or information without notice.

Visit Our Website for More Information. We Build Custom Cables.  
Notes: Cable assembly max frequency may be lower than connector or coax max frequency

# 18 GHZ TEST CABLE ASSEMBLIES

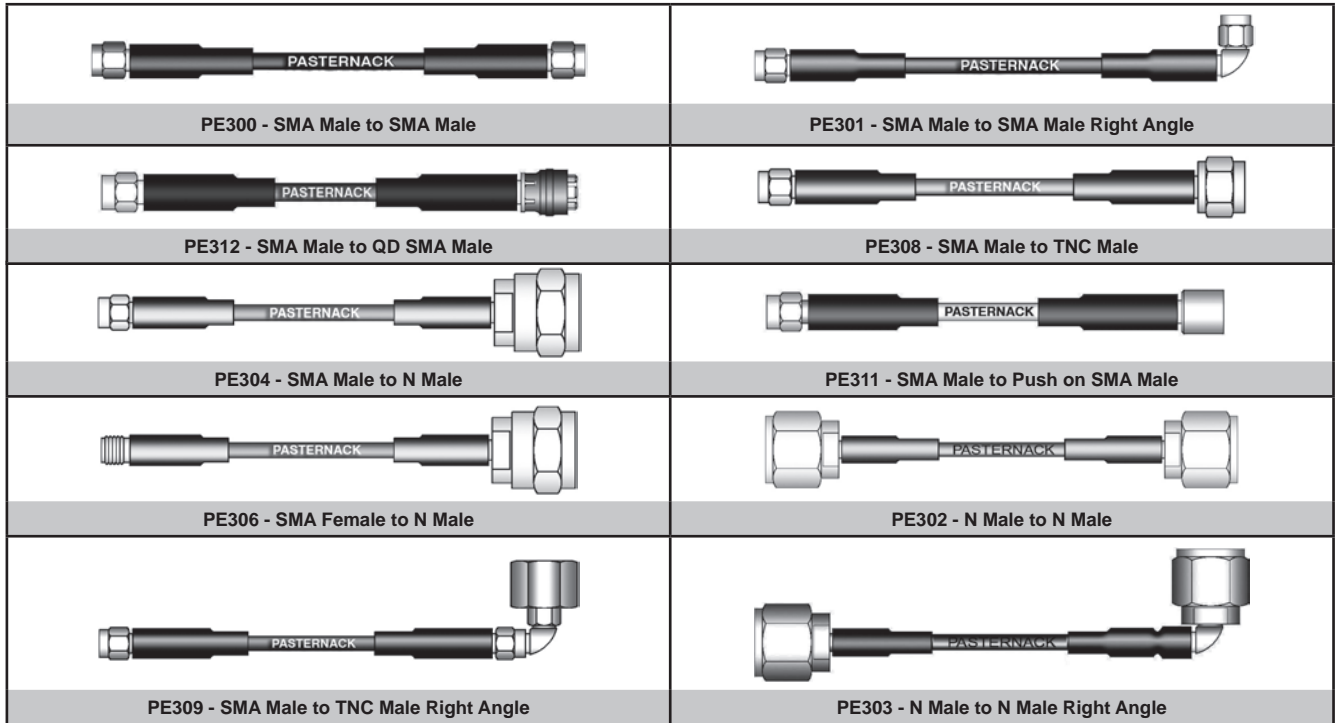

Cable Assemblies

## Standard Length Pricing

P/N	Connector 1	Connector 2	Price Breaks	Length (in.)						ROW	
				-12	-24	-36	-48	-60	-72		-120
PE300	SMA Male	SMA Male	1-9	\$88.56	\$91.20	\$95.20	\$99.05	\$102.65	\$104.37	\$152.55	1
			10-24	82.36	84.82	88.54	92.12	95.46	97.06	141.87	
			25 +	76.16	78.43	81.87	85.18	88.28	89.76	131.19	
PE301	SMA Male	SMA Male Right Angle	1-9	110.70	114.00	122.51	123.72	126.97	130.26	190.55	2
			10-24	102.95	106.02	113.93	115.06	118.08	121.14	177.21	
			25 +	95.20	98.04	105.36	106.40	109.19	112.02	163.87	
PE302	N Male	N Male	1-9	124.84	128.59	133.05	137.40	142.72	145.26	162.33	3
			10-24	116.10	119.59	123.74	127.78	132.73	135.09	150.97	
			25 +	107.36	110.59	114.42	118.16	122.74	124.92	139.60	
PE303	N Male	N Male Right Angle	1-9	137.86	141.15	145.16	149.36	152.15	154.93	178.09	4
			10-24	128.21	131.27	135.00	138.90	141.50	144.08	165.62	
			25 +	118.56	121.39	124.84	128.45	130.85	133.24	153.16	
PE304	SMA Male	N Male	1-9	119.42	125.45	128.03	136.90	141.86	146.93	155.29	5
			10-24	111.06	116.67	119.07	127.32	131.93	136.64	144.42	
			25 +	102.70	107.89	110.11	117.73	122.00	126.36	133.55	
PE306	SMA Female	N Male	1-9	141.15	150.93	152.70	164.86	172.21	177.12	195.41	6
			10-24	131.27	140.36	142.01	153.32	160.16	164.72	181.73	
			25 +	121.39	129.80	131.32	141.78	148.10	152.32	168.05	
PE308	SMA Male	TNC Male	1-9	124.84	128.64	132.39	136.09	138.57	141.10	157.57	7
			10-24	116.10	119.64	123.12	126.56	128.87	131.22	146.54	
			25 +	107.36	110.63	113.86	117.04	119.17	121.35	135.51	
PE309	SMA Male	TNC Male Right Angle	1-9	142.22	146.57	150.83	155.14	157.92	160.86	184.98	8
			10-24	132.26	136.31	140.27	144.28	146.87	149.60	172.03	
			25 +	122.31	126.05	129.71	133.42	135.81	138.34	159.08	
PE311	SMA Male	Push on SMA Male	1-9	104.78	110.91	112.32	118.61	119.92	123.72	138.97	9
			10-24	97.45	103.15	104.46	110.31	111.53	115.06	129.24	
			25 +	90.11	95.38	96.60	102.00	103.13	106.40	119.51	
PE312	SMA Male	QD SMA Male	1-9	104.78	108.52	112.32	116.17	119.92	123.72	138.97	10
			10-24	97.45	100.92	104.46	108.04	111.53	115.06	129.24	
			25 +	90.11	93.33	96.60	99.91	103.13	106.40	119.51	

Visit Our Website for More Information. We Build Custom Cables. Notes: Cable assembly max frequency may be lower than connector or coax max frequency.

Free Freight Available via UPS Ground to USA & Canada

Real-Time Stock Levels & Pricing On Our WebSite

Toll-Free Technical Support (866) 727-8376

Same-Day Shipping, Even Custom Cable Assemblies



# 26.5 GHZ ARMORED TEST CABLE ASSEMBLIES

## Product Features

- Rugged Armored Jacket
- 1.38 Inch [3.5cm] Bend Radius
- RoHS Compliant

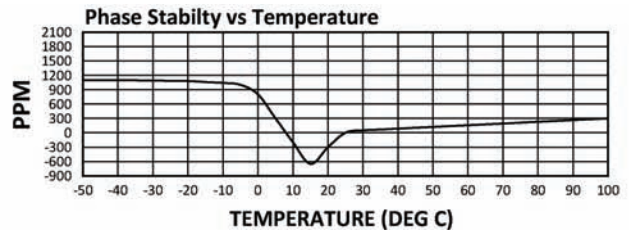
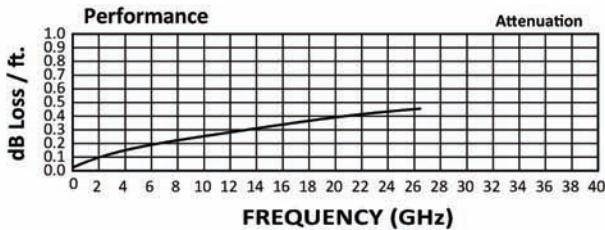

## Description

The 26.5 GHz Test Cables are highly suitable for severe test environments where rugged construction is necessary, or in any location where higher phase stability is needed. Their low-loss PTFE dielectric and solid center conductor ensure low insertion loss and outstanding phase & amplitude stability. Durable Passivated Stainless Steel connectors ensure repeated secure matings, while external armoring prevents bending the cable beyond it's minimum bend radius.

## Electrical Specifications <sup>(1)</sup>

Parameter	Units	Value	Description
Frequency Range	GHz	DC-26.5	
Impedance	Ohms	50Ω	
*Maximum VSWR	GHz	DC-10, 10-18, 18-26.5	DC-10 GHz, 1:15:1 / 10-18 GHz, 1.20:1 / 18-26.5 GHz, 1.35:1
Velocity of Propagation	%	77.0	
Max Operating Voltage	V	1000	RMS
Phase Stability	Degs	1500 PPM (Max)	from 0° C to 60° C
RF Shielding (at 1 GHz)	dB	<-100	
Power Rating (CW)	Watts	286	@ 10 GHz

\*See Website for detailed VSWR Specifications for each PE Part Number.

## Mechanical Specifications <sup>(1)</sup>

Parameter	Units	Value	Description
Minimum Bend Radius	in. [cm]	1.38 [3.51]	
Temperature Range	C	-55° to +165°	
Flex Life Bending		10,000	Min
Mating Torque	in.-lbs. [N-M]	8 [.90]	
Jacket Diameter	in. [cm]	0.47 [1.19]	Armored



PE315 - 3.5mm Male to 3.5mm Male



PE317 - 3.5mm Male to 3.5mm Female

## Standard Length Pricing

P/N	Connector 1	Connector 2	Price Breaks	Length (in.)			ROW
				-24	-36	-72	
PE315	3.5mm Male	3.5mm Male	1-9	\$660.11	\$807.60	\$1,103.79	1
			10-24	613.90	751.07	1026.52	
			25 +	567.69	694.54	949.26	
PE317	3.5mm Male	3.5mm Female	1-9	700.49	809.07	1134.90	2
			10-24	651.46	752.44	1055.46	
			25 +	602.42	695.80	976.01	

Visit our website at [www.Pasternack.com](http://www.Pasternack.com) to see our wide selection of RF products.

(1) Pasternack reserves the right to change specifications or information without notice.

ROHS & REACH COMPLIANT. CUSTOM-LENGTH CABLE ASSEMBLIES MAY BE ORDERED ON OUR WEBSITE.

[www.pasternack.com](http://www.pasternack.com)

Toll-Free: 866-727-8376

Phone: 949-261-1920

Fax: 949-261-7451

# 40 GHZ ARMORED TEST CABLE ASSEMBLIES

## Product Features

- Rugged Armored Jacket
- 1.38 Inch [3.5cm] Bend Radius
- RoHS Compliant

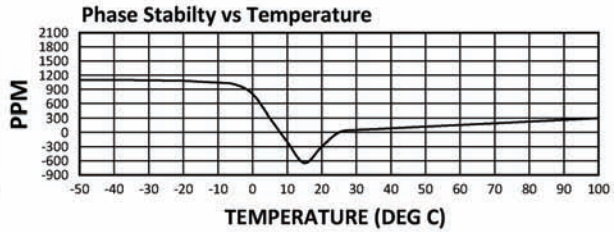
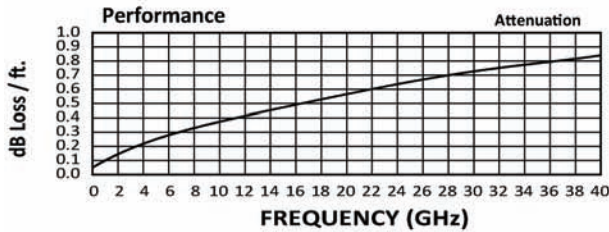

## Description

The 40 GHz Test Cables are highly suitable for severe test environments where rugged construction is necessary, or in any location where higher phase stability is needed. Their low-loss PTFE dielectric and solid center conductor ensure low insertion loss and outstanding phase & amplitude stability. Durable Passivated Stainless Steel connectors ensure repeated secure matings, while external armoring prevents bending the cable beyond its minimum bend radius.

## Electrical Specifications <sup>(1)</sup>

Parameter	Units	Value	Description
Frequency Range	GHz	DC-40	
Impedance	Ohms	50Ω	
*Maximum VSWR	GHz	DC-18, 18-26, 26-40	DC-18 GHz, 1:20:1 / 18-26 GHz, 1.25:1 / 26-40 GHz, 1.35:1
Velocity of Propagation	%	77.0	
Max Operating Voltage	V	1000	RMS
Phase Stability	Degs	1500 PPM (Max)	from 0° C to 60° C
RF Shielding (at 1 GHz)	dB	<-100	
Power Rating (CW)	Watts	150	@ 10 GHz

\*See Website for detailed VSWR Specifications for each PE Part Number.

## Mechanical Specifications <sup>(1)</sup>

Parameter	Units	Value	Description
Minimum Bend Radius	in. [cm]	1.38 [3.51]	
Temperature Range	C	-55° to +165°	
Flex Life Bending		10,000	Min
Mating Torque	in.-lbs. [N-M]	8 [.90]	
Jacket Diameter	in. [cm]	0.36 [0.91]	Armored



PE319 - 2.92mm Male to 2.92mm Male



PE321 - 2.92mm Male to 2.92mm Female

## Standard Length Pricing

P/N	Connector 1	Connector 2	Price Breaks	Length (in.)			ROW
				-24	-36	-72	
PE319	2.92mm Male	2.92mm Male	1-9	\$809.07	\$961.12	\$1,417.25	1
			10-24	752.44	893.84	1318.04	
			25 +	695.80	826.56	1218.84	
PE321	2.92mm Male	2.92mm Female	1-9	863.38	1015.43	1471.56	2
			10-24	802.94	944.35	1368.55	
			25 +	742.51	873.27	1265.54	

Visit our website at [www.Pasternack.com](http://www.Pasternack.com) to see our wide selection of RF products.

(1) Pasternack reserves the right to change specifications or information without notice.

# 150 SERIES CABLE ASSEMBLIES

## Product Features

- 18 GHz N & TNC, 26.5 GHz SMA
- Reinforced Coaxial Interface
- 1 Inch [2.5cm] Bend Radius
- Single Shielded Coax Cable

## Description

The 26.5 GHz Flexible Cable Assembly series offer precision N & TNC connectors that operate to 18 GHz, and an SMA connector with excellent performance to 26.5 GHz. The coax provides excellent isolation and low loss performance to 26.5 GHz.

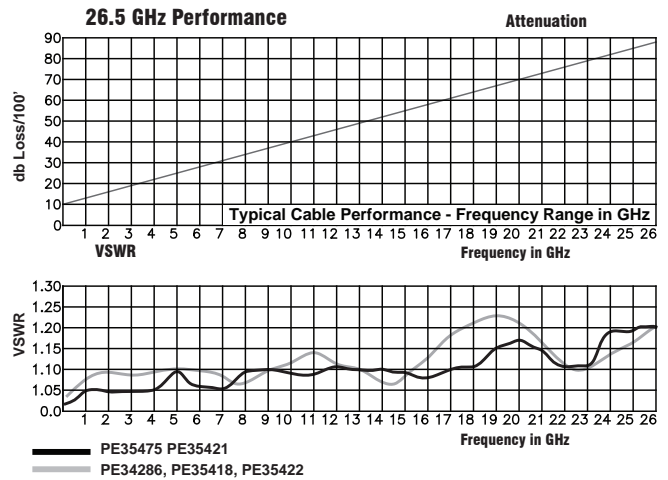
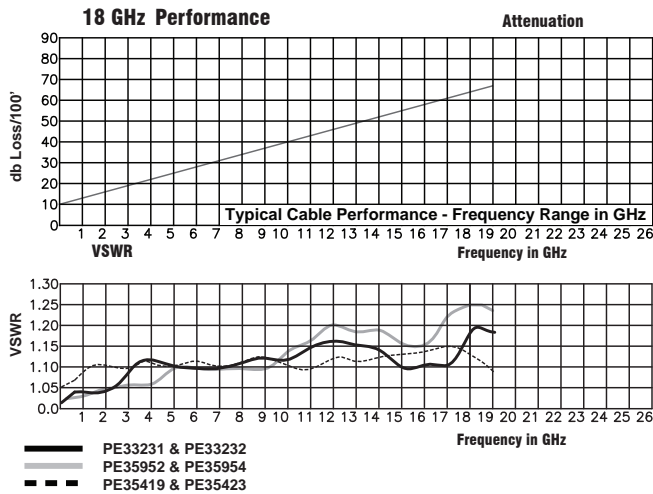

## Electrical Specifications <sup>(1)</sup>

Parameter	Units	Value	Description
Impedance	Ohms	50Ω	
Frequency	GHz	DC to 18, 26.5	TNC & N Connector to 18 GHz, SMA to 26.5 GHz
*Maximum VSWR	GHz	DC to 12, 12-26	DC-12 GHz, 1:20:1 / 12-26 GHz, 1.30:1
Cutoff Frequency	GHz	35	
Max Operating Voltage	V	1900	RMS
Nominal Capacitance	pF / ft.	29.4	
Velocity of Propagation	%	69.5	
RF Shielding	dB	>90	

\*See Website for detailed VSWR Specifications for each PE Part Number.

## Mechanical Specifications <sup>(1)</sup>









Parameter	Units	Value	Description
Minimum Bend Radius	in. [cm]	1.0 [2.5]	
Operating Temperature	C	-50° to +205°	
Inner Conductor Diameter	in. [cm]	0.036 [.09]	Silver plated Cu Clad Steel
Dielectric Diameter	in. [cm]	0.116 [.29]	PTFE
Jacket Diameter	in. [cm]	0.150 [.38]	FEP

(1) Pasternack reserves the right to change specifications or information without notice.



# 150 SERIES CABLE ASSEMBLIES

See Page 246 for Mounting Holes

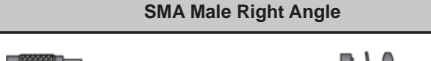
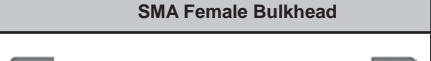
		 Mounting Hole B02
PE34286 - SMA Male to SMA Male	PE35418 - SMA Male to SMA Male R/A	PE35475 - SMA Male to SMA Female Bulkhead
	 Mounting Hole G01	
PE33231 - SMA Male to N Male	PE35954 - SMA Male to N Female Bulkhead	PE35419 - SMA Male to TNC Male
	 Mounting Hole B02	
PE35422 - SMA Male Right Angle to SMA Male Right Angle	PE35421 - SMA Male Right Angle to SMA Female Bulkhead	PE33232 - N Male to N Male
 Mounting Hole G01		<b>For Custom Lengths or Special Configurations, Please call (949) 261-1920 or Visit <a href="http://www.pasternack.com">www.pasternack.com</a></b>
PE35952 - N Male to N Female Bulkhead	PE35423 - TNC Male to TNC Male	

Cable Assemblies

## Standard Length Pricing

P/N	Connector 1	Connector 2	Freq GHz	Price Breaks	Length (in.)								ROW	
					-6	-12	-18	-24	-30	-36	-48	-60		-72
PE34286	SMA Male	SMA Male	26.5	1-24	\$61.30	\$64.40	\$67.33	\$70.42	\$73.67	\$76.55	\$82.74	\$88.87	\$94.90	1
				25-49	57.01	59.89	62.62	65.49	68.51	71.19	76.95	82.65	88.26	
				50-99	52.72	55.38	57.90	60.56	63.36	65.83	71.16	76.43	81.61	
PE35418	SMA Male	SMA Male Right Angle	26.5	1-24	106.75	110.30	113.89	117.44	121.09	124.59	131.63	142.98	145.92	2
				25-49	99.28	102.58	105.92	109.22	112.61	115.87	122.42	132.97	135.71	
				50-99	91.81	94.86	97.95	101.00	104.14	107.15	113.20	122.96	125.49	
PE35475	SMA Male	SMA Female Bulkhead	26.5	1-24	79.49	82.38	85.22	88.06	90.94	93.88	99.61	105.38	111.11	3
				25-49	73.93	76.61	79.25	81.90	84.57	87.31	92.64	98.00	103.33	
				50-99	68.36	70.85	73.29	75.73	78.21	80.74	85.66	90.63	95.55	
PE33231	SMA Male	N Male	18	1-24	79.49	82.38	85.22	88.06	90.94	93.88	99.61	105.38	111.11	4
				25-49	73.93	76.61	79.25	81.90	84.57	87.31	92.64	98.00	103.33	
				50-99	68.36	70.85	73.29	75.73	78.21	80.74	85.66	90.63	95.55	
PE35954	SMA Male	N Female Bulkhead	18	1-24	91.45	94.24	97.07	99.91	102.60	105.38	111.01	116.68	122.31	5
				25-49	85.05	87.64	90.28	92.92	95.42	98.00	103.24	108.51	113.75	
				50-99	78.65	81.05	83.48	85.92	88.24	90.63	95.47	100.34	105.19	
PE35419	SMA Male	TNC Male	18	1-24	96.01	99.30	102.50	105.69	108.93	112.07	118.40	124.99	131.27	6
				25-49	89.29	92.35	95.33	98.29	101.30	104.23	110.11	116.24	122.08	
				50-99	82.57	85.40	88.15	90.89	93.68	96.38	101.82	107.49	112.89	
PE35422	SMA Male Right Angle	SMA Male Right Angle	26.5	1-24	141.91	145.61	149.11	152.70	156.25	159.85	166.89	173.93	181.03	7
				25-49	131.98	135.42	138.67	142.01	145.31	148.66	155.21	161.75	168.36	
				50-99	122.04	125.22	128.23	131.32	134.38	137.47	143.53	149.58	155.69	
PE35421	SMA Male Right Angle	SMA Female Bulkhead	26.5	1-24	108.22	111.36	114.30	117.44	120.63	123.62	129.85	136.04	142.22	8
				25-49	100.64	103.56	106.30	109.22	112.19	114.97	120.76	126.52	132.26	
				50-99	93.07	95.77	98.30	101.00	103.74	106.31	111.67	116.99	122.31	
PE33232	N Male	N Male	18	1-24	90.74	93.78	96.77	99.86	102.85	105.84	111.87	117.95	123.93	9
				25-49	84.39	87.22	90.00	92.87	95.65	98.43	104.04	109.69	115.25	
				50-99	78.04	80.65	83.22	85.88	88.45	91.02	96.21	101.44	106.58	
PE35952	N Male	N Female Bulkhead	18	1-24	102.85	105.74	108.68	111.67	114.45	117.39	123.42	129.25	135.12	10
				25-49	95.65	98.34	101.07	103.85	106.44	109.17	114.78	120.20	125.66	
				50-99	88.45	90.94	93.46	96.04	98.43	100.96	106.14	111.16	116.20	
PE35423	TNC Male	TNC Male	18	1-24	108.22	111.36	114.30	117.44	120.58	123.62	129.85	136.04	142.22	11
				25-49	100.64	103.56	106.30	109.22	112.14	114.97	120.76	126.52	132.26	
				50-99	93.07	95.77	98.30	101.00	103.70	106.31	111.67	116.99	122.31	

Visit Our Website for More Information. We Build Custom Cables. Notes: Cable assembly max frequency may be lower than connector or coax max frequency

 Free Freight Available via UPS Ground to USA & Canada

 Real-Time Stock Levels & Pricing On Our Website

 Toll-Free Technical Support (866) 727-8376

 Same-Day Shipping, Even Custom Cable Assemblies

# 165 SERIES CABLE ASSEMBLIES

## Product Features

- 18 GHz N & 26.5 GHz SMA
- Reinforced Coaxial Interface
- 1 Inch [2.5cm] Bend Radius
- Triple Shielded Coax Cable

## Description

The 26.5 GHz Flexible Cable Assembly series offer precision N connectors that operate to 18 GHz, and an SMA connector with excellent performance to 26.5 GHz. The coax provides excellent isolation and low loss performance to 26.5 GHz. These cable assemblies are constructed using non-magnetic materials.

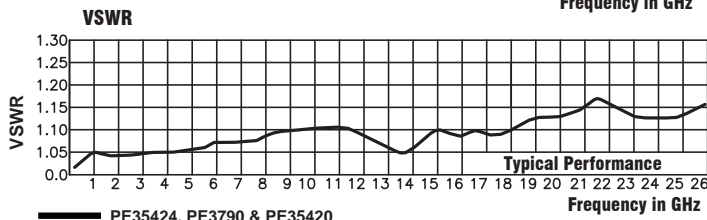
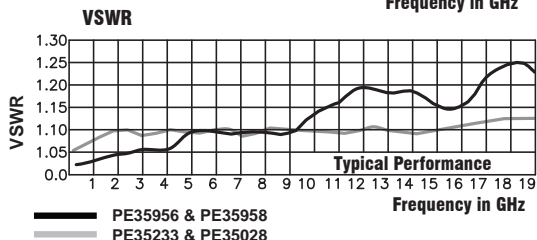
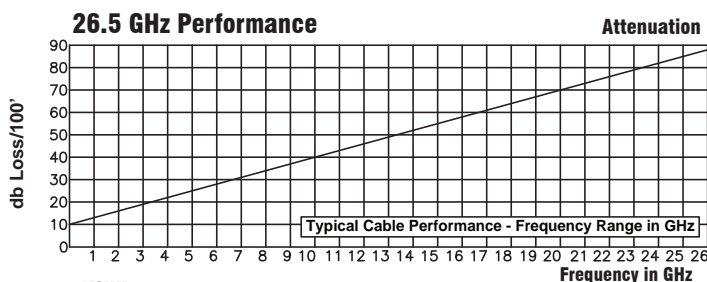
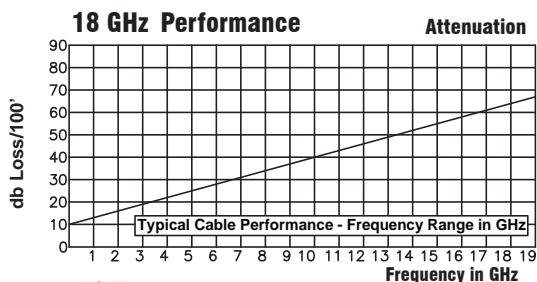

Visit Our Website for More Information. We Build Custom Cables.  
Notes: Cable assembly max frequency may be lower than connector or coax max frequency

## Electrical Specifications <sup>(1)</sup>

Parameter	Units	Value	Description
Impedance	Ohms	50Ω	
Frequency	GHz	DC to 18, 26.5	N Connector to 18 GHz, SMA to 26.5
*Maximum VSWR	GHz	DC-18, 18-26.5	DC-18 GHz, 1:15:1 / 18-26.5 GHz, 1.25:1
Cutoff Frequency	GHz	35	
Max Operating Voltage	V	1900	RMS
Nominal Capacitance	pF / ft.	29.4	
Velocity of Propagation	%	69.5	
RF Shielding	dB	>90	

\*See Website for detailed VSWR Specifications for each PE Part Number.

## Mechanical Specifications <sup>(1)</sup>





Parameter	Units	Value	Description
Minimum Bend Radius	in. [cm]	1.0 [2.5]	
Operating Temperature	C	-50° to +205°	
Inner Conductor Diameter	in. [cm]	0.036 [.09]	Silver plated Beryllium Cu
Dielectric Diameter	in. [cm]	0.116 [.29]	PTFE
Jacket Diameter	in. [cm]	0.165 [.42]	FEP

(1) Pasternack reserves the right to change specifications or information without notice.

ROHS & REACH COMPLIANT. CUSTOM-LENGTH CABLE ASSEMBLIES MAY BE ORDERED ON OUR WEBSITE.

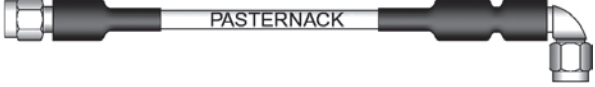
# 165 SERIES CABLE ASSEMBLIES

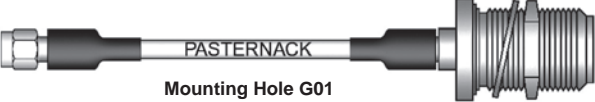
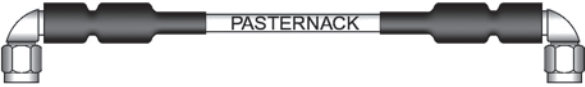
See Page 246 for Mounting Holes

	
PE3790 - SMA Male to SMA Male	PE35420 - SMA Male to SMA Male Right Angle
	
PE33233 - SMA Male to N Male	PE35958 - SMA Male to N Female Bulkhead Mounting Hole G01
	
PE35424 - SMA Male Right Angle to SMA Male Right Angle	PE35028 - N Male to N Male
	<p><b>For Custom Lengths or Special Configurations, Please call (949) 261-1920 or Visit <a href="http://www.pasternack.com">www.pasternack.com</a></b></p>
PE35956 - N Male to N Female Bulkhead Mounting Hole G01	

Cable Assemblies

Visit Our Website for More Information. We Build Custom Cables.  
Notes: Cable assembly max frequency may be lower than connector or coax max frequency.

## Standard Length Pricing

P/N	Connector 1	Connector 2	Freq GHz	Price Breaks	Length (in.)								ROW	
					-6	-12	-18	-24	-30	-36	-48	-60		-72
PE3790	SMA Male	SMA Male	26.5	1-24	\$89.68	\$94.90	\$100.32	\$105.69	\$111.01	\$116.58	\$127.27	\$137.96	\$148.75	1
				25-49	83.40	88.26	93.30	98.29	103.24	108.42	118.36	128.30	138.34	
				50-99	77.12	81.61	86.28	90.89	95.47	100.26	109.45	118.65	127.93	
PE35420	SMA Male	SMA Male Right Angle	26.5	1-24	137.30	142.42	147.59	152.70	157.87	162.99	173.43	182.09	193.95	2
				25-49	127.69	132.45	137.26	142.01	146.82	151.58	161.29	169.34	180.37	
				50-99	118.08	122.48	126.93	131.32	135.77	140.17	149.15	156.60	166.80	
PE33233	SMA Male	N Male	18	1-24	107.21	112.53	117.95	123.37	130.51	137.66	144.75	157.26	166.13	3
				25-49	99.71	104.65	109.69	114.73	121.37	128.02	134.62	146.25	154.50	
				50-99	92.20	96.78	101.44	106.10	112.24	118.39	124.49	135.24	142.87	
PE35958	SMA Male	N Female Bulkhead	18	1-24	113.69	116.83	120.03	123.37	126.61	129.85	136.29	142.82	149.41	4
				25-49	105.73	108.65	111.63	114.73	117.75	120.76	126.75	132.82	138.95	
				50-99	97.77	100.47	103.23	106.10	108.88	111.67	117.21	122.83	128.49	
PE35424	SMA Male Right Angle	SMA Male Right Angle	26.5	1-24	172.56	177.83	182.75	188.02	193.13	198.10	208.33	218.52	228.60	5
				25-49	160.48	165.38	169.96	174.86	179.61	184.23	193.75	203.22	212.60	
				50-99	148.40	152.93	157.17	161.70	166.09	170.37	179.16	187.93	196.60	
PE35028	N Male	N Male	18	1-24	118.76	124.18	129.65	135.12	140.60	146.17	157.06	169.68	186.04	6
				25-49	110.45	115.49	120.57	125.66	130.76	135.94	146.07	157.80	173.02	
				50-99	102.13	106.79	111.50	116.20	120.92	125.71	135.07	145.92	159.99	
PE35956	N Male	N Female Bulkhead	18	1-24	135.88	139.43	143.13	146.83	150.42	154.07	161.32	168.56	175.76	7
				25-49	126.37	129.67	133.11	136.55	139.89	143.29	150.03	156.76	163.46	
				50-99	116.86	119.91	123.09	126.27	129.36	132.50	138.74	144.96	151.15	

For Custom Lengths or Special Configurations, Please call (949) 261-1920 or visit [www.Pasternack.com](http://www.Pasternack.com) for Pricing.



Real-Time Stock Levels & Pricing On Our WebSite



Toll-Free Technical Support (866) 727-8376



Same-Day Shipping, Even Custom Cable Assemblies



# 095 SERIES CABLE ASSEMBLIES

Cable Assemblies

## Product Features

- Operation to 65 GHz using 1.85mm connectors
- Double shielding construction for high isolation
- Flexible .095 inch [0.24cm] coaxial diameter
- A bend radius of 1 inch [2.54cm]

## Description

A miniature and flexible cable with frequency of operation to 65 GHz is designed with a silver plated ribbon and braid for excellent isolation. Its flexibility is great for routing within communications hardware. The cable assemblies are offered in a combination of 2.92mm, 2.4mm and 1.85mm connectors to meet a wide variety of millimeter wave applications.

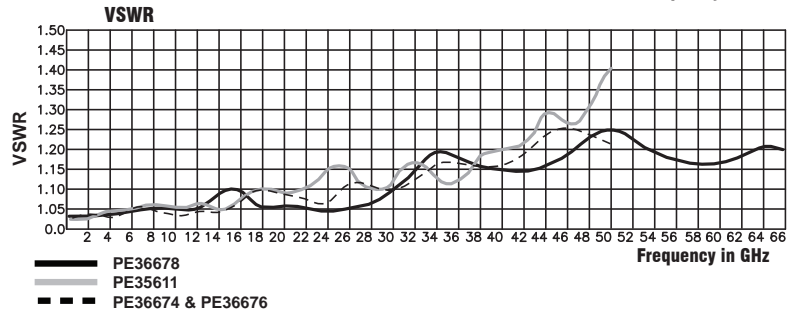
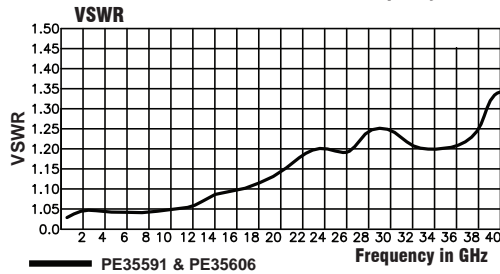
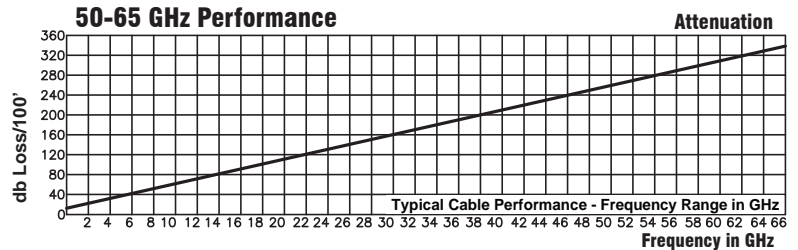
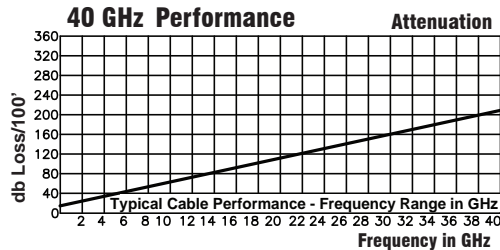

## Electrical Specifications <sup>(1)</sup>

Parameter	Units	Value	Description
Impedance	Ohms	50Ω	
Frequency	GHz	DC to 40, 50, 65	2.92mm-40 GHz, 2.4mm-50 GHz, 1.85mm-65 GHz
*Maximum VSWR	GHz	DC-6, 6-18, 27-65	DC-6 GHz, 1:10:1 / 6-18 GHz, 1.15:1 / 27-65 GHz, 1.20:1
Cutoff Frequency	GHz	60	
Max Operating Voltage	V	1200	RMS
Nominal Capacitance	pF / ft.	29.4	
Velocity of Propagation	%	69.5	
RF Shielding	dB	>90	

\*See Website for detailed VSWR Specifications for each PE Part Number.

## Mechanical Specifications <sup>(1)</sup>

Parameter	Units	Value	Description
Minimum Bend Radius	in. [cm]	1 [2.54]	
Operating Temperature	C	-50° to +205°	
Inner Conductor Diameter	in. [cm]	0.020 [.05]	Silver plated Cu Clad Steel
Dielectric Diameter	in. [cm]	0.066 [.17]	PTFE
Jacket Diameter	in. [cm]	0.095 [.24]	FEP







(1) Pasternack reserves the right to change specifications or information without notice.

ROHS & REACH COMPLIANT. CUSTOM-LENGTH CABLE ASSEMBLIES MAY BE ORDERED ON OUR WEBSITE.

Visit Our Website for More Information. We Build Custom Cables.  
Notes: Cable assembly max frequency may be lower than connector or coax max frequency

# 095 SERIES CABLE ASSEMBLIES

Cable Assemblies

	
PE35591 - 2.92mm Male to 2.92mm Male	PE35606 - 2.92mm Male to 2.4mm Male
	
PE36674 - 2.92mm Male to 1.85mm Male	PE35611 - 2.4mm Male to 2.4mm Male
	
PE36676 - 2.4mm Male to 1.85mm Male	PE36678 - 1.85mm Male to 1.85mm Male

**For Custom Lengths or Special Configurations,  
Please call (949) 261-1920 or  
Visit [www.pasternack.com](http://www.pasternack.com)**

## Standard Length Pricing

P/N	Connector 1	Connector 2	Freq GHz	Price Breaks	Length (in.)								ROW	
					-6	-12	-18	-24	-30	-36	-48	-60		-72
PE35591	2.92mm Male	2.92mm Male	40	1-24	\$114.50	\$118.25	\$122.20	\$123.37	\$129.75	\$133.60	\$141.20	\$145.81	\$153.16	1
				25-49	106.49	109.97	113.65	114.73	120.67	124.25	131.32	135.60	142.44	
				50-99	98.47	101.70	105.09	106.10	111.59	114.90	121.43	125.40	131.72	
PE35606	2.92mm Male	2.4mm Male	40	1-24	118.40	122.05	125.60	129.20	136.29	139.99	143.48	150.73	157.97	2
				25-49	110.11	113.51	116.81	120.16	126.75	130.19	133.44	140.18	146.91	
				50-99	101.82	104.96	108.02	111.11	117.21	120.39	123.39	129.63	135.85	
PE36674	2.92mm Male	1.85mm Male	40	1-24	124.43	127.98	131.48	135.12	138.72	142.22	149.41	156.35	163.55	3
				25-49	115.72	119.02	122.28	125.66	129.01	132.26	138.95	145.41	152.10	
				50-99	107.01	110.06	113.07	116.20	119.30	122.31	128.49	134.46	140.65	
PE35611	2.4mm Male	2.4mm Male	50	1-24	124.43	127.98	134.31	138.01	141.36	150.73	152.65	156.35	163.55	4
				25-49	115.72	119.02	124.91	128.35	131.46	140.18	141.96	145.41	152.10	
				50-99	107.01	110.06	115.51	118.69	121.57	129.63	131.28	134.46	140.65	
PE36676	2.4mm Male	1.85mm Male	50	1-24	130.46	133.91	137.50	141.00	144.45	148.09	155.19	162.23	169.12	5
				25-49	121.33	124.54	127.88	131.13	134.34	137.72	144.33	150.87	157.28	
				50-99	112.20	115.16	118.25	121.26	124.23	127.36	133.46	139.52	145.44	
PE36678	1.85mm Male	1.85mm Male	65	1-24	141.71	145.26	149.01	152.70	156.30	159.95	167.19	174.49	181.79	6
				25-49	131.79	135.09	138.58	142.01	145.36	148.75	155.49	162.28	169.06	
				50-99	121.87	124.92	128.15	131.32	134.42	137.56	143.78	150.06	156.34	

**For Custom Lengths or Special Configurations, Please call (949) 261-1920 or  
visit [www.Pasternack.com](http://www.Pasternack.com) for Pricing.**

Visit Our Website for More Information. We Build Custom Cables.  
Notes: Cable assembly max frequency may be lower than connector or coax max frequency



Real-Time Stock Levels & Pricing On Our WebSite



Toll-Free Technical Support (866) 727-8376



Same-Day Shipping, Even Custom Cable Assemblies

**NEW**

# SMA FORMABLE PRECISION CABLE ASSEMBLIES

Pasternack's Formable Precision Cable Assemblies are 100% RF tested. These precision cable assemblies are available in 086 type and 141 type formable cable and can be ordered with or without a Black FEP Jacket material. Standard lengths from 6 to 24 inches are available for same day shipment. Custom length cables are also available upon request by contacting Pasternack Customer Service, directly, or through our website at [www.pasternack.com](http://www.pasternack.com).

## Product Features

- 100% VSWR Tested to Max Frequency
- 100% Hi-Pot & Continuity Tested
- Stainless Steel coupling nut Ni/Au-plated brass body
- Anti Torque Straight SMA connectors
- Hand formable flexible semirigid
- ROHS Compliant

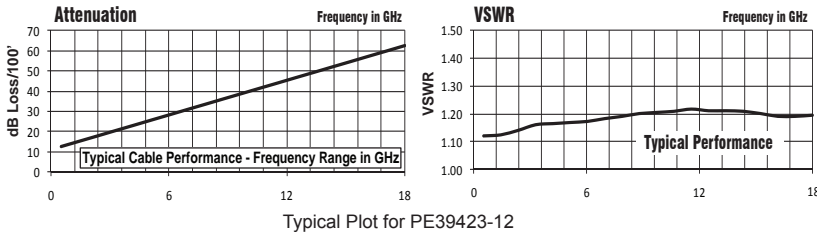

## Electrical Specifications <sup>(1)</sup>

Parameter	Units	SMA Straight	SMA Right Angle	MCX/ MMCX
Frequency	GHz	DC to 18 GHz	DC to 10 GHz	DC to 6 GHz
Maximum VSWR		1.35:1	1.35:1	1.35:1
Impedance	Ohms	50		
Velocity of Propagation	%	69.5		
RF Shielding	dB	>100 dB		
Max Operating Voltage	Volts	335 VRMS	335 VRMS	170 VRMS

## Mechanical Specifications <sup>(1)</sup>

Parameter	Units	086 Tin Braid	086 Jacketed	141 Tin Braid	141 Jacketed
Jacket Diameter	Inches	0.086	0.100	0.141	0.161
Outer Conductor Dia.	Inches	0.086		0.141	0.141
Dielectric Diameter	Inches	0.065		0.116	
Inner Conductor Dia.	Inches	0.020		0.036	
Min Bend Radius	Inches	0.37		0.75	
Jacket Material		Tinned Braid	Black FEP	Tinned Braid	Black FEP
Operating Temperature	Deg C	-65° to +125°			

(1) Pasternack reserves the right to change specifications or information without notice.

See Page 246 for Mounting Holes

SMA Male to SMA Male	SMA Male to SMA Male R/A	SMA Male R/A to SMA Male R/A
SMA Male to SMA Female	SMA Male to SMA Female Bulkhead	SMA Male R/A to SMA Female Bulkhead
		<p><b>For Custom Lengths or Special Configurations, Please call (949) 261-1920 or Visit <a href="http://www.pasternack.com">www.pasternack.com</a></b></p>
SMA Female Bulkhead to MMCX Plug R/A	SMA Female Bulkhead to MCX Plug R/A	

Connector 1	Connector 2	Freq GHz	Cable Dia.	Jacketed	P/N	Price Breaks	Length (in.)					ROW
							-6	-9	-12	-18	-24	
SMA Male	SMA Male	18	.100"	X	PE39429	1-24	\$37.24	\$39.52	\$41.80	\$46.36	\$50.92	1
						25-49	34.63	36.75	38.87	43.11	47.36	
						50-99	32.03	33.99	35.95	39.87	43.79	
			.086"		PE39415	1-24	\$35.47	\$37.75	\$40.03	\$44.59	\$49.15	2
						25-49	32.99	35.11	37.23	41.47	45.71	
						50-99	30.50	32.47	34.43	38.35	42.27	
			.161"	X	PE39437	1-24	\$37.24	\$39.37	\$41.49	\$45.75	\$50.01	3
						25-49	34.63	36.61	38.59	42.55	46.51	
						50-99	32.03	33.86	35.68	39.35	43.01	
			.141"		PE39423	1-24	\$35.47	\$37.59	\$39.72	\$43.98	\$48.23	4
						25-49	32.99	34.96	36.94	40.90	44.85	
						50-99	30.50	32.33	34.16	37.82	41.48	

Cable Assemblies

Visit Our Website for More Information. We Build Custom Cables. Notes: Cable assembly max frequency may be lower than connector or coax max frequency

ROHS & REACH COMPLIANT. CUSTOM-LENGTH CABLE ASSEMBLIES MAY BE ORDERED ON OUR WEBSITE.



Connector 1	Connector 2	Freq GHz	Cable Dia.	Jacketed	P/N	Price Breaks	Length (in.)					ROW
							-6	-9	-12	-18	-24	
SMA Male	SMA Male Right Angle	10	.100"	X	PE39431	1-24	\$39.77	\$42.05	\$44.33	\$48.89	\$53.45	1
						25-49	36.99	39.11	41.23	45.47	49.71	
						50-99	34.20	36.16	38.12	42.05	45.97	
			.086"		PE39417	1-24	\$38.00	\$40.28	\$42.56	\$47.12	\$51.68	2
						25-49	35.34	37.46	39.58	43.82	48.06	
						50-99	32.68	34.64	36.60	40.52	44.44	
		.161"	X	PE39439	1-24	\$39.77	\$41.90	\$44.03	\$48.28	\$52.54	3	
					25-49	36.99	38.97	40.95	44.90	48.86		
					50-99	34.20	36.03	37.87	41.52	45.18		
		.141"		PE39425	1-24	\$38.00	\$40.13	\$42.25	\$46.51	\$50.77	4	
					25-49	35.34	37.32	39.29	43.25	47.22		
					50-99	32.68	34.51	36.34	40.00	43.66		
SMA Male Right Angle	SMA Male Right Angle	10	.100"	X	PE39430	1-24	\$42.31	\$44.59	\$46.87	\$51.42	\$55.98	5
						25-49	39.35	41.47	43.59	47.82	52.06	
						50-99	36.39	38.35	40.31	44.22	48.14	
			.086"		PE39416	1-24	\$40.53	\$42.81	\$45.09	\$49.65	\$54.21	6
						25-49	37.69	39.81	41.93	46.17	50.42	
						50-99	34.86	36.82	38.78	42.70	46.62	
		.161"	X	PE39438	1-24	\$42.31	\$44.43	\$46.56	\$50.82	\$55.07	7	
					25-49	39.35	41.32	43.30	47.26	51.22		
					50-99	36.39	38.21	40.04	43.71	47.36		
		.141"		PE39424	1-24	\$40.53	\$42.66	\$44.79	\$49.04	\$53.30	8	
					25-49	37.69	39.67	41.65	45.61	49.57		
					50-99	34.86	36.69	38.52	42.17	45.84		
SMA Male	SMA Female	18	.100"	X	PE39432	1-24	\$42.31	\$44.59	\$46.87	\$51.42	\$55.98	9
						25-49	39.35	41.47	43.59	47.82	52.06	
						50-99	36.39	38.35	40.31	44.22	48.14	
			.086"		PE39418	1-24	\$40.53	\$42.81	\$45.09	\$49.65	\$54.21	10
						25-49	37.69	39.81	41.93	46.17	50.42	
						50-99	34.86	36.82	38.78	42.70	46.62	
		.161"	X	PE39440	1-24	\$42.31	\$44.43	\$46.56	\$50.82	\$55.07	11	
					25-49	39.35	41.32	43.30	47.26	51.22		
					50-99	36.39	38.21	40.04	43.71	47.36		
		.141"		PE39426	1-24	\$40.53	\$42.66	\$44.79	\$49.04	\$53.30	12	
					25-49	37.69	39.67	41.65	45.61	49.57		
					50-99	34.86	36.69	38.52	42.17	45.84		
SMA Male	SMA Female Bulkhead	18	.100"	X	PE39433	1-24	\$42.31	\$44.59	\$46.87	\$51.42	\$55.98	13
						25-49	39.35	41.47	43.59	47.82	52.06	
						50-99	36.39	38.35	40.31	44.22	48.14	
			.086"		PE39419	1-24	\$40.53	\$42.81	\$45.09	\$49.65	\$54.21	14
						25-49	37.69	39.81	41.93	46.17	50.42	
						50-99	34.86	36.82	38.78	42.70	46.62	
		.161"	X	PE39441	1-24	\$42.31	\$44.43	\$46.56	\$50.82	\$55.07	15	
					25-49	39.35	41.32	43.30	47.26	51.22		
					50-99	36.39	38.21	40.04	43.71	47.36		
		.141"		PE39427	1-24	\$40.53	\$42.66	\$44.79	\$49.04	\$53.30	16	
					25-49	37.69	39.67	41.65	45.61	49.57		
					50-99	34.86	36.69	38.52	42.17	45.84		
SMA Male Right Angle	SMA Female Bulkhead	10	.100"	X	PE39434	1-24	\$43.32	\$45.60	\$47.88	\$52.44	\$57.00	17
						25-49	40.29	42.41	44.53	48.77	53.01	
						50-99	37.26	39.22	41.18	45.10	49.02	
			.086"		PE39420	1-24	\$41.55	\$43.83	\$46.11	\$50.67	\$55.22	18
						25-49	38.64	40.76	42.88	47.12	51.35	
						50-99	35.73	37.69	39.65	43.58	47.49	
		.161"	X	PE39442	1-24	\$43.32	\$45.45	\$47.57	\$51.83	\$56.09	19	
					25-49	40.29	42.27	44.24	48.20	52.16		
					50-99	37.26	39.09	40.91	44.57	48.24		
		.141"		PE39428	1-24	\$41.55	\$43.67	\$45.80	\$50.06	\$54.31	20	
					25-49	38.64	40.61	42.59	46.56	50.51		
					50-99	35.73	37.56	39.39	43.05	46.71		
SMA Female Bulkhead	MMCX Plug Right Angle	6	.100"	X	PE39436	1-24	\$43.32	\$45.60	\$47.88	\$52.44	\$57.00	21
						25-49	40.29	42.41	44.53	48.77	53.01	
						50-99	37.26	39.22	41.18	45.10	49.02	
		.086"		PE39422	1-24	\$41.55	\$43.83	\$46.11	\$50.67	\$55.22	22	
					25-49	38.64	40.76	42.88	47.12	51.35		
					50-99	35.73	37.69	39.65	43.58	47.49		
SMA Female Bulkhead	MCX Plug Right Angle	6	.100"	X	PE39435	1-24	\$41.55	\$43.83	\$46.11	\$50.67	\$55.22	23
						25-49	38.64	40.76	42.88	47.12	51.35	
						50-99	35.73	37.69	39.65	43.58	47.49	
		.086"		PE39421	1-24	\$39.52	\$41.80	\$44.08	\$48.64	\$53.20	24	
					25-49	36.75	38.87	40.99	45.24	49.48		
					50-99	33.99	35.95	37.91	41.83	45.75		

**NEW**

# N FORMABLE PRECISION CABLE ASSEMBLIES

Pasternack's Formable Precision Cable Assemblies are 100% RF tested. These precision cable assemblies are available in 086 type and 141 type formable cable and can be ordered with or without a Black FEP Jacket material. Standard lengths from 6 to 24 inches are available for same day shipment. Custom length cables are also available upon request by contacting Pasternack Customer Service, directly, or through our website at [www.pasternack.com](http://www.pasternack.com).

## Product Features

- 100% VSWR Tested to Max Frequency
- 100% Hi-Pot & Continuity Tested
- Ni plated brass coupling nut and brass body
- Hand formable flexible semirigid
- ROHS Compliant

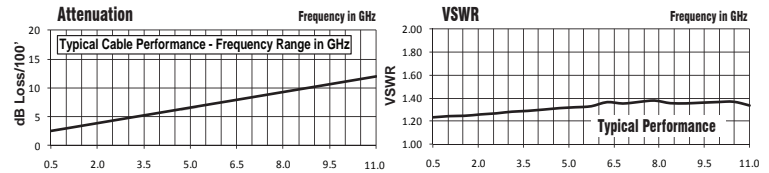

Typical Plot for PE39451-12

## Electrical Specifications <sup>(1)</sup>

Parameter	Units	N Straight	N Right Angle	MCX/ MMCX
Frequency	GHz	DC to 11 GHz	DC to 11 GHz	DC to 6 GHz
Maximum VSWR		1.35:1 (Male) / 1.50:1 (Female)	1.50:1	1.35:1
Impedance	Ohms	50		
Velocity of Propagation	%	69.5		
RF Shielding	dB	>100 dB		
Max Operating Voltage	Volts	350 VRMS	350 VRMS	170 VRMS

## Mechanical Specifications <sup>(1)</sup>

Parameter	Units	086 Tin Braid	086 Jacketed	141 Tin Braid	141 Jacketed
Jacket Diameter	Inches	0.086	0.100	0.141	0.161
Outer Conductor Dia.	Inches	0.086		0.141	
Dielectric Diameter	Inches	0.065		0.116	
Inner Conductor Dia.	Inches	0.020		0.036	
Min Bend Radius	Inches	0.37		0.75	
Jacket Material		Tinned Braid	Black FEP	Tinned Braid	Black FEP
Operating Temperature	Deg C	-65° to +125°			

<sup>(1)</sup> Pasternack reserves the right to change specifications or information without notice.

See Page 246 for Mounting Holes

N Male to N Male	N Male to N Male R/A	N Male R/A to N Male R/A
N Male to N Female	N Female Bulkhead to SMA Male	N Female Bulkhead to SMA Male R/A
		<p><b>For Custom Lengths or Special Configurations, Please call (949) 261-1920 or Visit <a href="http://www.pasternack.com">www.pasternack.com</a></b></p>
N Female Bulkhead to MMCX Plug R/A	N Female Bulkhead to MCX Plug R/A	

Connector 1	Connector 2	Freq GHz	Cable Dia.	Jacketed	P/N	Price Breaks	Length (in.)					ROW	
							-6	-9	-12	-18	-24		
N Male	N Male	11	.100"	X	PE39457	1-24	\$49.40	\$51.68	\$53.96	\$58.52	\$63.08	1	
						25-49	45.94	48.06	50.18	54.42	58.66		
						50-99	42.48	44.44	46.41	50.33	54.25		
						1-24	\$47.88	\$50.16	\$52.44	\$57.00	\$61.56		2
						25-49	44.53	46.65	48.77	53.01	57.25		
						50-99	41.18	43.14	45.10	49.02	52.94		
			1-24	\$49.40	\$51.53	\$53.65	\$57.91	\$62.17	3				
			25-49	45.94	47.92	49.89	53.86	57.82					
			50-99	42.48	44.32	46.14	49.80	53.47					
			1-24	\$47.88	\$50.01	\$52.13	\$56.39	\$60.65		4			
			25-49	44.53	46.51	48.48	52.44	56.40					
			50-99	41.18	43.01	44.83	48.50	52.16					

ROHS & REACH COMPLIANT. CUSTOM-LENGTH CABLE ASSEMBLIES MAY BE ORDERED ON OUR WEBSITE.

[www.pasternack.com](http://www.pasternack.com)

Toll-Free: 866-727-8376

Phone: 949-261-1920

Fax: 949-261-7451

Connector 1	Connector 2	Freq GHz	Cable Dia.	Jacketed	P/N	Price Breaks	Length (in.)					ROW
							-6	-9	-12	-18	-24	
N Male	N Male Right Angle	11	.100"	X	PE39459	1-24	\$54.46	\$56.74	\$59.02	\$63.58	\$68.14	1
						25-49	50.65	52.77	54.89	59.13	63.37	
						50-99	46.84	48.80	50.76	54.68	58.60	
			.086"		PE39445	1-24	\$52.94	\$55.22	\$57.50	\$62.06	\$66.62	2
						25-49	49.23	51.35	53.48	57.72	61.96	
						50-99	45.53	47.49	49.45	53.37	57.29	
			.161"	X	PE39467	1-24	\$54.46	\$56.59	\$58.72	\$62.98	\$67.23	3
						25-49	50.65	52.63	54.61	58.57	62.52	
						50-99	46.84	48.67	50.50	54.16	57.82	
			.141"		PE39453	1-24	\$52.94	\$55.07	\$57.20	\$61.46	\$65.71	4
						25-49	49.23	51.22	53.20	57.16	61.11	
						50-99	45.53	47.36	49.19	52.86	56.51	
N Male Right Angle	N Male Right Angle	11	.100"	X	PE39458	1-24	\$60.04	\$62.32	\$64.60	\$69.16	\$73.72	5
						25-49	55.84	57.96	60.08	64.32	68.56	
						50-99	51.63	53.60	55.56	59.48	63.40	
			.086"		PE39444	1-24	\$58.26	\$60.54	\$62.82	\$67.38	\$71.94	6
						25-49	54.18	56.30	58.42	62.66	66.90	
						50-99	50.10	52.06	54.03	57.95	61.87	
			.161"	X	PE39466	1-24	\$60.04	\$62.17	\$64.29	\$68.55	\$72.81	7
						25-49	55.84	57.82	59.79	63.75	67.71	
						50-99	51.63	53.47	55.29	58.95	62.62	
			.141"		PE39452	1-24	\$58.26	\$60.39	\$62.52	\$66.78	\$71.03	8
						25-49	54.18	56.16	58.14	62.11	66.06	
						50-99	50.10	51.94	53.77	57.43	61.09	
N Male	N Female	11	.100"	X	PE39460	1-24	\$50.16	\$52.44	\$54.72	\$59.28	\$63.84	9
						25-49	46.65	48.77	50.89	55.13	59.37	
						50-99	43.14	45.10	47.06	50.98	54.90	
			.086"		PE39446	1-24	\$48.64	\$50.92	\$53.20	\$57.76	\$62.32	10
						25-49	45.24	47.36	49.48	53.72	57.96	
						50-99	41.83	43.79	45.75	49.67	53.60	
			.161"	X	PE39468	1-24	\$50.16	\$52.29	\$54.41	\$58.67	\$62.93	11
						25-49	46.65	48.63	50.60	54.56	58.52	
						50-99	43.14	44.97	46.79	50.46	54.12	
			.141"		PE39454	1-24	\$48.64	\$50.77	\$52.89	\$57.15	\$61.41	12
						25-49	45.24	47.22	49.19	53.15	57.11	
						50-99	41.83	43.66	45.49	49.15	52.81	
N Female Bulkhead	SMA Male	11	.100"	X	PE39461	1-24	\$54.46	\$56.74	\$59.02	\$63.58	\$68.14	13
						25-49	50.65	52.77	54.89	59.13	63.37	
						50-99	46.84	48.80	50.76	54.68	58.60	
			.086"		PE39447	1-24	\$52.94	\$55.22	\$57.50	\$62.06	\$66.62	14
						25-49	49.23	51.35	53.48	57.72	61.96	
						50-99	45.53	47.49	49.45	53.37	57.29	
			.161"	X	PE39469	1-24	\$54.46	\$56.59	\$58.72	\$62.98	\$67.23	15
						25-49	50.65	52.63	54.61	58.57	62.52	
						50-99	46.84	48.67	50.50	54.16	57.82	
			.141"		PE39455	1-24	\$52.94	\$55.07	\$57.20	\$61.46	\$65.71	16
						25-49	49.23	51.22	53.20	57.16	61.11	
						50-99	45.53	47.36	49.19	52.86	56.51	
N Female Bulkhead	SMA Male Right Angle	10	.100"	X	PE39462	1-24	\$49.40	\$51.68	\$53.96	\$58.52	\$63.08	17
						25-49	45.94	48.06	50.18	54.42	58.66	
						50-99	42.48	44.44	46.41	50.33	54.25	
			.086"		PE39448	1-24	\$47.88	\$50.16	\$52.44	\$57.00	\$61.56	18
						25-49	44.53	46.65	48.77	53.01	57.25	
						50-99	41.18	43.14	45.10	49.02	52.94	
			.161"	X	PE39470	1-24	\$49.40	\$51.53	\$53.65	\$57.91	\$62.17	19
						25-49	45.94	47.92	49.89	53.86	57.82	
						50-99	42.48	44.32	46.14	49.80	53.47	
			.141"		PE39456	1-24	\$47.88	\$50.01	\$52.13	\$56.39	\$60.65	20
						25-49	44.53	46.51	48.48	52.44	56.40	
						50-99	41.18	43.01	44.83	48.50	52.16	
N Female Bulkhead	MMCX Plug Right Angle	6	.100"	X	PE39464	1-24	\$49.40	\$51.68	\$53.96	\$58.52	\$63.08	21
						25-49	45.94	48.06	50.18	54.42	58.66	
						50-99	42.48	44.44	46.41	50.33	54.25	
			.086"		PE39450	1-24	\$47.88	\$50.16	\$52.44	\$57.00	\$61.56	22
						25-49	44.53	46.65	48.77	53.01	57.25	
						50-99	41.18	43.14	45.10	49.02	52.94	
N Female Bulkhead	MCX Plug Right Angle	6	.100"	X	PE39463	1-24	\$47.88	\$50.16	\$52.44	\$57.00	\$61.56	23
						25-49	44.53	46.65	48.77	53.01	57.25	
						50-99	41.18	43.14	45.10	49.02	52.94	
			.086"		PE39449	1-24	\$46.11	\$48.39	\$50.67	\$55.22	\$59.78	24
						25-49	42.88	45.00	47.12	51.35	55.60	
						50-99	39.65	41.62	43.58	47.49	51.41	



# NEW TNC FORMABLE PRECISION CABLE ASSEMBLIES

Pasternack's Formable Precision Cable Assemblies are 100% RF tested. These precision cable assemblies are available in 086 type and 141 type formable cable and can be ordered with or without a Black FEP Jacket material. Standard lengths from 6 to 24 inches are available for same day shipment. Custom length cables are also available upon request by contacting Pasternack Customer Service, directly, or through our website at [www.pasternack.com](http://www.pasternack.com).

## Product Features

- 100% VSWR Tested to Max Frequency
- 100% Hi-Pot & Continuity Tested
- Ni plated brass coupling nut and brass body
- Hand formable flexible semirigid
- ROHS Compliant

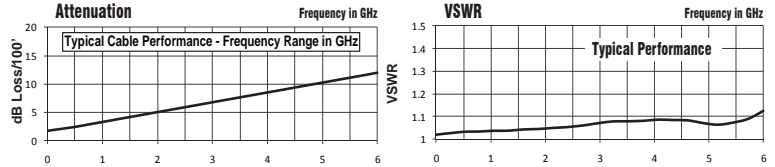

Typical Plot for PE39479-12

## Electrical Specifications <sup>(1)</sup>

Parameter	Units	TNC Straight	TNC Right Angle	MCX/ MMCX
Frequency	GHz	DC to 6 GHz	DC to 6 GHz	DC to 6 GHz
Maximum VSWR		1.35:1	1.50:1	1.35:1
Impedance	Ohms	50		
Velocity of Propagation	%	69.5		
RF Shielding	dB	>100 dB		
Max Operating Voltage	Volts	500 VRMS	500 VRMS	170 VRMS

## Mechanical Specifications <sup>(1)</sup>

Parameter	Units	086 Tin Braid	086 Jacketed	141 Tin Braid	141 Jacketed
Jacket Diameter	Inches	0.086	0.100	0.141	0.161
Outer Conductor Dia.	Inches	0.086		0.141	
Dielectric Diameter	Inches	0.065		0.116	
Inner Conductor Dia.	Inches	0.020		0.036	
Min Bend Radius	Inches	0.37		0.75	
Jacket Material		Tinned Braid	Black FEP	Tinned Braid	Black FEP
Operating Temperature	Deg C	-65° to +125°			

(1) Pasternack reserves the right to change specifications or information without notice.

See Page 246 for Mounting Holes

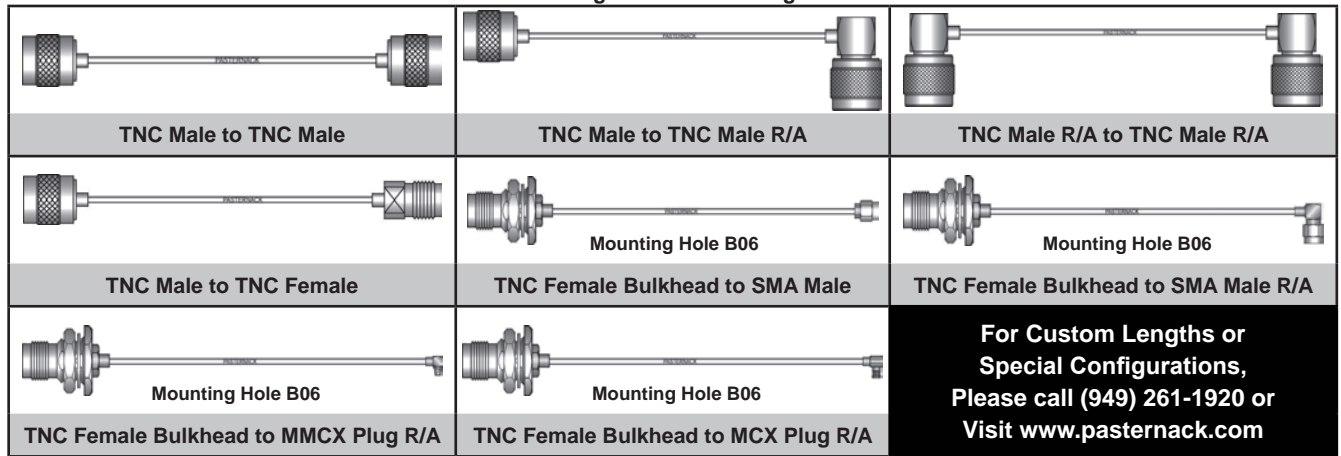



Connector 1	Connector 2	Freq GHz	Cable Dia.	Jacketed	P/N	Price Breaks	Length (in.)					ROW				
							-6	-9	-12	-18	-24					
TNC Male	TNC Male	6	.100"	X	PE39485	1-24	\$40.79	\$43.07	\$45.35	\$49.91	\$54.46	1				
						25-49	37.93	40.06	42.18	46.42	50.65					
						50-99	35.08	37.04	39.00	42.92	46.84					
						1-24	\$39.27	\$41.55	\$43.83	\$48.39	\$52.94		2			
						25-49	36.52	38.64	40.76	45.00	49.23					
						50-99	33.77	35.73	37.69	41.62	45.53					
			.161"	X	PE39493	1-24	\$40.79	\$42.91	\$45.04	\$49.30	\$53.55	3				
						25-49	37.93	39.91	41.89	45.85	49.80					
						50-99	35.08	36.90	38.73	42.40	46.05					
						.141"		PE39479	1-24	\$39.27	\$41.39		\$43.52	\$47.78	\$52.03	4
									25-49	36.52	38.49		40.47	44.44	48.39	
									50-99	33.77	35.60		37.43	41.09	44.75	

Connector 1	Connector 2	Freq GHz	Cable Dia.	Jacketed	P/N	Price Breaks	Length (in.)					ROW
							-6	-9	-12	-18	-24	
TNC Male	TNC Male Right Angle	6	.100"	X	PE39487	1-24	\$43.32	\$45.60	\$47.88	\$52.44	\$57.00	1
						25-49	40.29	42.41	44.53	48.77	53.01	2
						50-99	37.26	39.22	41.18	45.10	49.02	3
			.086"		PE39473	1-24	\$41.80	\$44.08	\$46.36	\$50.92	\$55.48	4
						25-49	38.87	40.99	43.11	47.36	51.60	5
						50-99	35.95	37.91	39.87	43.79	47.71	6
			.161"	X	PE39495	1-24	\$43.32	\$45.45	\$47.57	\$51.83	\$56.09	7
						25-49	40.29	42.27	44.24	48.20	52.16	8
						50-99	37.26	39.09	40.91	44.57	48.24	9
			.141"		PE39481	1-24	\$41.80	\$43.93	\$46.05	\$50.31	\$54.57	10
						25-49	38.87	40.85	42.83	46.79	50.75	11
						50-99	35.95	37.78	39.60	43.27	46.93	12
TNC Male Right Angle	TNC Male Right Angle	6	.100"	X	PE39486	1-24	\$45.85	\$48.13	\$50.41	\$54.97	\$59.53	13
						25-49	42.64	44.76	46.88	51.12	55.36	14
						50-99	39.43	41.39	43.35	47.27	51.20	15
			.086"		PE39472	1-24	\$44.33	\$46.61	\$48.89	\$53.45	\$58.01	16
						25-49	41.23	43.35	45.47	49.71	53.95	17
						50-99	38.12	40.08	42.05	45.97	49.89	18
			.161"	X	PE39494	1-24	\$45.85	\$47.98	\$50.11	\$54.36	\$58.62	19
						25-49	42.64	44.62	46.60	50.55	54.52	20
						50-99	39.43	41.26	43.09	46.75	50.41	21
			.141"		PE39480	1-24	\$44.33	\$46.46	\$48.59	\$52.84	\$57.10	22
						25-49	41.23	43.21	45.19	49.14	53.10	23
						50-99	38.12	39.96	41.79	45.44	49.11	24
TNC Male	TNC Female	6	.100"	X	PE39488	1-24	\$40.79	\$43.07	\$45.35	\$49.91	\$54.46	25
						25-49	37.93	40.06	42.18	46.42	50.65	26
						50-99	35.08	37.04	39.00	42.92	46.84	27
			.086"		PE39474	1-24	\$39.27	\$41.55	\$43.83	\$48.39	\$52.94	28
						25-49	36.52	38.64	40.76	45.00	49.23	29
						50-99	33.77	35.73	37.69	41.62	45.53	30
			.161"	X	PE39496	1-24	\$40.79	\$42.91	\$45.04	\$49.30	\$53.55	31
						25-49	37.93	39.91	41.89	45.85	49.80	32
						50-99	35.08	36.90	38.73	42.40	46.05	33
			.141"		PE39482	1-24	\$39.27	\$41.39	\$43.52	\$47.78	\$52.03	34
						25-49	36.52	38.49	40.47	44.44	48.39	35
						50-99	33.77	35.60	37.43	41.09	44.75	36
TNC Female Bulkhead	SMA Male	6	.100"	X	PE39489	1-24	\$47.88	\$50.16	\$52.44	\$57.00	\$61.56	37
						25-49	44.53	46.65	48.77	53.01	57.25	38
						50-99	41.18	43.14	45.10	49.02	52.94	39
			.086"		PE39475	1-24	\$46.11	\$48.39	\$50.67	\$55.22	\$59.78	40
						25-49	42.88	45.00	47.12	51.35	55.60	41
						50-99	39.65	41.62	43.58	47.49	51.41	42
			.161"	X	PE39497	1-24	\$47.88	\$50.01	\$52.13	\$56.39	\$60.65	43
						25-49	44.53	46.51	48.48	52.44	56.40	44
						50-99	41.18	43.01	44.83	48.50	52.16	45
			.141"		PE39483	1-24	\$46.11	\$48.23	\$50.36	\$54.62	\$58.87	46
						25-49	42.88	44.85	46.83	50.80	54.75	47
						50-99	39.65	41.48	43.31	46.97	50.63	48
TNC Female Bulkhead	SMA Male Right Angle	6	.100"	X	PE39490	1-24	\$46.87	\$49.15	\$51.42	\$55.98	\$60.54	49
						25-49	43.59	45.71	47.82	52.06	56.30	50
						50-99	40.31	42.27	44.22	48.14	52.06	51
			.086"		PE39476	1-24	\$45.09	\$47.37	\$49.65	\$54.21	\$58.77	52
						25-49	41.93	44.05	46.17	50.42	54.66	53
						50-99	38.78	40.74	42.70	46.62	50.54	54
			.161"	X	PE39498	1-24	\$46.87	\$48.99	\$51.12	\$55.38	\$59.63	55
						25-49	43.59	45.56	47.54	51.50	55.46	56
						50-99	40.31	42.13	43.96	47.63	51.28	57
			.141"		PE39484	1-24	\$45.09	\$47.22	\$49.35	\$53.60	\$57.86	58
						25-49	41.93	43.91	45.90	49.85	53.81	59
						50-99	38.78	40.61	42.44	46.10	49.76	60
TNC Female Bulkhead	MMCX Plug Right Angle	6	.100"	X	PE39492	1-24	\$46.87	\$49.15	\$51.42	\$55.98	\$60.54	61
						25-49	43.59	45.71	47.82	52.06	56.30	62
						50-99	40.31	42.27	44.22	48.14	52.06	63
			.086"		PE39478	1-24	\$45.09	\$47.37	\$49.65	\$54.21	\$58.77	64
						25-49	41.93	44.05	46.17	50.42	54.66	65
						50-99	38.78	40.74	42.70	46.62	50.54	66
TNC Female Bulkhead	MCX Plug Right Angle	6	.100"	X	PE39491	1-24	\$45.09	\$47.37	\$49.65	\$54.21	\$58.77	67
						25-49	41.93	44.05	46.17	50.42	54.66	68
						50-99	38.78	40.74	42.70	46.62	50.54	69
			.086"		PE39477	1-24	\$43.57	\$45.85	\$48.13	\$52.69	\$57.25	70
						25-49	40.52	42.64	44.76	49.00	53.24	71
						50-99	37.47	39.43	41.39	45.31	49.24	72

Cable Assemblies

\*Coax Performance at 1 GHz  
Notes: Cable assembly max frequency may be lower than connector or coax max frequency

SMA MALE TO SMA MALE									
									
Cable Dia.	Atten.*	Max Power*	Length	Model No.	1-24	25-49	50-99		
<b>Precision Flexible Cable Assemblies</b>									
<b>Please see precision section, page 6-29</b>									
50 Ohm, 150 Series Coax				PE34286					1
50 Ohm, 165 Non-Magnetic Series Coax				PE3790					2
50 Ohm, 300 Series Coax				PE300					3
<b>Precision Formable Cable Assemblies</b>									
<b>Please see precision section, page 6-29</b>									
50 Ohm, PE-SR402FL Coax				PE39423					4
50 Ohm, PE-SR402FLJ Jacketed Coax				PE39437					5
50 Ohm, PE-SR405FL Coax				PE39415					6
50 Ohm, PE-SR405FLJ Jacketed Coax				PE39429					7
<b>Standard Flexible Cable Assemblies</b>									
<b>See website for the following cable(s)</b>									
50 Ohm, RG8X Coax				PE39087					8
53.5 Ohm, RG55B/U Coax				PE3572					9
<b>50 Ohm, RG58C/U Coax</b>									
0.195" dia.	20 dB / 100 ft.	44 W	12"	PE3369-12	\$37.15	\$34.55	\$31.95		10
			24"	PE3369-24	\$37.50	\$34.88	\$32.25		
			36"	PE3369-36	\$37.90	\$35.25	\$32.59		
			48"	PE3369-48	\$38.35	\$35.67	\$32.98		
			60"	PE3369-60	\$38.85	\$36.13	\$33.41		
			Any	PE3369-XX	See Website for Pricing				
<b>See website for the following cable(s)</b>									
93 Ohm, RG62A/U Coax				PE3899					11
<b>50 Ohm, RG142B/U Coax</b>									
0.195" dia.	13 dB / 100 ft.	650 W	12"	PE3385-12	\$41.00	\$38.13	\$35.26		12
			24"	PE3385-24	\$43.70	\$40.64	\$37.58		
			36"	PE3385-36	\$46.45	\$43.20	\$39.95		
			48"	PE3385-48	\$49.15	\$45.71	\$42.27		
			60"	PE3385-60	\$51.90	\$48.27	\$44.63		
Any	PE3385-XX	See Website for Pricing							
<b>50 Ohm, RG174A/U Coax</b>									
0.100" dia.	31 dB / 100 ft.	16 W	12"	PE3353-12	\$38.15	\$35.48	\$32.81		13
			24"	PE3353-24	\$38.60	\$35.90	\$33.20		
			36"	PE3353-36	\$39.05	\$36.32	\$33.58		
			48"	PE3353-48	\$39.45	\$36.69	\$33.93		
			60"	PE3353-60	\$39.90	\$37.11	\$34.31		
Any	PE3353-XX	See Website for Pricing							
<b>50 Ohm, RG178B/U Coax</b>									
0.750" dia.	45 dB / 100 ft.	78 W	12"	PE3574-12	\$52.40	\$48.73	\$45.06		14
			24"	PE3574-24	\$53.35	\$49.62	\$45.88		
			36"	PE3574-36	\$54.40	\$50.59	\$46.78		
			48"	PE3574-48	\$55.40	\$51.52	\$47.64		
			60"	PE3574-60	\$56.30	\$52.36	\$48.42		
Any	PE3574-XX	See Website for Pricing							
<b>See website for the following cable(s)</b>									
95 Ohm, RG180B/U Twinax				PE3245					15
<b>50 Ohm, RG188A/U Coax</b>									
0.110" dia.	30 dB / 100 ft.	160 W	12"	PE3361-12	\$39.45	\$36.69	\$33.93		16
			24"	PE3361-24	\$41.15	\$38.27	\$35.39		
			36"	PE3361-36	\$42.80	\$39.80	\$36.81		
			48"	PE3361-48	\$44.50	\$41.39	\$38.27		
			60"	PE3361-60	\$46.20	\$42.97	\$39.73		
Any	PE3361-XX	See Website for Pricing							
<b>See website for the following cable(s)</b>									
50 Ohm, RG188-DS Coax				PE3778					17

SMA MALE TO SMA MALE									
									
Cable Dia.	Atten.*	Max Power*	Length	Model No.	1-24	25-49	50-99		
<b>50 Ohm, RG214/U Coax</b>									
0.425" dia.	9 dB / 100 ft.	190 W	12"	PE3121-12	\$146.15	\$135.92	\$125.69		18
			24"	PE3121-24	\$151.90	\$141.27	\$130.63		
			36"	PE3121-36	\$157.65	\$146.61	\$135.58		
			48"	PE3121-48	\$163.40	\$151.96	\$140.52		
			60"	PE3121-60	\$169.15	\$157.31	\$145.47		
			Any	PE3121-XX	See Website for Pricing				
<b>50 Ohm, RG223/U Coax</b>									
0.216" dia.	16.5 dB / 100 ft.	53 W	12"	PE3377-12	\$37.55	\$34.92	\$32.29		19
			24"	PE3377-24	\$38.95	\$36.22	\$33.50		
			36"	PE3377-36	\$40.25	\$37.43	\$34.62		
			48"	PE3377-48	\$41.60	\$38.69	\$35.78		
			60"	PE3377-60	\$43.00	\$39.99	\$36.98		
			Any	PE3377-XX	See Website for Pricing				
<b>50 Ohm, RG316/U Coax</b>									
0.102" dia.	30 dB / 100 ft.	160 W	12"	PE3573-12	\$40.15	\$37.34	\$34.53		20
			24"	PE3573-24	\$42.50	\$39.53	\$36.55		
			36"	PE3573-36	\$44.90	\$41.76	\$38.61		
			48"	PE3573-48	\$47.30	\$43.99	\$40.68		
			60"	PE3573-60	\$49.70	\$46.22	\$42.74		
			Any	PE3573-XX	See Website for Pricing				
<b>50 Ohm, RG316-DS Coax</b>									
0.114" dia.	30 dB / 100 ft.	160 W	12"	PE3704-12	\$38.50	\$35.81	\$33.11		21
			24"	PE3704-24	\$40.75	\$37.90	\$35.05		
			36"	PE3704-36	\$43.05	\$40.04	\$37.02		
			48"	PE3704-48	\$45.30	\$42.13	\$38.96		
			60"	PE3704-60	\$47.60	\$44.27	\$40.94		
Any	PE3704-XX	See Website for Pricing							
<b>50 Ohm, RG400/U Coax</b>									
0.195" dia.	13 dB / 100 ft.	650 W	12"	PE3500-12	\$41.00	\$38.13	\$35.26		22
			24"	PE3500-24	\$43.85	\$40.78	\$37.71		
			36"	PE3500-36	\$49.25	\$45.80	\$42.36		
			48"	PE3500-48	\$54.70	\$50.87	\$47.04		
			60"	PE3500-60	\$60.15	\$55.94	\$51.73		
Any	PE3500-XX	See Website for Pricing							
<b>See website for the following cable(s)</b>									
50 Ohm, PE-C100 Coax				PE37908					23
<b>50 Ohm, PE-C195 Coax</b>									
0.195" dia.	11.5 dB / 100 ft.	150 W	12"	PE35784-12	\$27.55	\$25.62	\$23.69		24
			24"	PE35784-24	\$28.65	\$26.64	\$24.64		
			36"	PE35784-36	\$29.75	\$27.67	\$25.59		
			48"	PE35784-48	\$30.85	\$28.69	\$26.53		
			60"	PE35784-60	\$32.00	\$29.76	\$27.52		
Any	PE35784-XX	See Website for Pricing							
<b>50 Ohm, PE-C240 Coax</b>									
0.240" dia.	8 dB / 100 ft.	250 W	12"	PE38628-12	\$40.85	\$37.99	\$35.13		25
			24"	PE38628-24	\$43.20	\$40.18	\$37.15		
			36"	PE38628-36	\$45.55	\$42.36	\$39.17		
			48"	PE38628-48	\$47.85	\$44.50	\$41.15		
			60"	PE38628-60	\$50.20	\$46.69	\$43.17		
Any	PE38628-XX	See Website for Pricing							
<b>See website for the following cable(s)</b>									
75 Ohm, RG59B/U Coax				PE3814					26
<b>75 Ohm, RG179B/U Coax</b>									
0.100" dia.	25 dB / 100 ft.	200 W	12"	PE3739-12	\$39.65	\$36.87	\$34.10		27
			24"	PE3739-24	\$41.50	\$38.60	\$35.69		
			36"	PE3739-36	\$43.40	\$40.36	\$37.32		
			48"	PE3739-48	\$45.25	\$42.08	\$38.92		
			60"	PE3739-60	\$47.15	\$43.85	\$40.55		
Any	PE3739-XX	See Website for Pricing							

Continued on Next Page

Continued from Previous Page

SMA MALE TO SMA MALE							
							
Cable Dia.	Atten.*	Max Power*	Length	Model No.	1-24	25-49	50-99
<b>50 Ohm, PE-P195 Coax</b>							
0.195" dia.	12.5 dB / 100 ft.	650 W	12"	PE3138-12	\$56.50	\$52.55	\$48.59
			24"	PE3138-24	\$60.20	\$55.99	\$51.77
			36"	PE3138-36	\$63.85	\$59.38	\$54.91
			48"	PE3138-48	\$67.65	\$62.91	\$58.18
			60"	PE3138-60	\$71.40	\$66.40	\$61.40
		Any	PE3138-XX	See Website for Pricing			
Standard Formable Cable Assemblies							
See website for the following cable(s)							
50 Ohm, PE-SR047FL Coax				PE34186			
<b>50 Ohm, PE-SR401FL Coax</b>							
0.250" dia.	7 dB / 100 ft.	1400 W	12"	PE34188-12	\$121.20	\$112.72	\$104.23
			24"	PE34188-24	\$128.60	\$119.60	\$110.60
			36"	PE34188-36	\$136.00	\$126.48	\$116.96
			48"	PE34188-48	\$143.60	\$133.55	\$123.50
			60"	PE34188-60	\$151.85	\$141.22	\$130.59
		Any	PE34188-XX	See Website for Pricing			
<b>50 Ohm, PE-SR402FL Coax</b>							
0.141" dia.	12 dB / 100 ft.	450 W	12"	PE3481-12	\$38.60	\$35.90	\$33.20
			24"	PE3481-24	\$44.55	\$41.43	\$38.31
			36"	PE3481-36	\$50.50	\$46.97	\$43.43
			48"	PE3481-48	\$56.45	\$52.50	\$48.55
			60"	PE3481-60	\$62.45	\$58.08	\$53.71
		Any	PE3481-XX	See Website for Pricing			
<b>50 Ohm, PE-SR405FL Coax</b>							
0.085" dia.	22 dB / 100 ft.	130 W	12"	PE3867-12	\$39.30	\$36.55	\$33.80
			24"	PE3867-24	\$47.50	\$44.18	\$40.85
			36"	PE3867-36	\$55.75	\$51.85	\$47.95
			48"	PE3867-48	\$61.35	\$57.06	\$52.76
			60"	PE3867-60	\$66.55	\$61.89	\$57.23
		Any	PE3867-XX	See Website for Pricing			
Standard Semirigid Cable Assemblies							
See website for the following cable(s)							
50 Ohm, PE-020SR Coax				PE34191			
50 Ohm, PE-034SR Coax				PE34193			
<b>50 Ohm, PE-047SR Coax</b>							
0.047" dia.	40 dB / 100 ft.	32 W	12"	PE3656-12	\$65.90	\$61.29	\$56.67
			24"	PE3656-24	\$72.00	\$66.96	\$61.92
			36"	PE3656-36	\$77.50	\$72.08	\$66.65
			48"	PE3656-48	\$82.60	\$76.82	\$71.04
			60"	PE3656-60	\$88.30	\$82.12	\$75.94
		Any	PE3656-XX	See Website for Pricing			
See website for the following cable(s)							
50 Ohm, PE-SR047AL Coax				PE3387			
50 Ohm, PE-SR401AL Coax				PE34184			
<b>50 Ohm, PE-SR402AL Coax</b>							
0.141" dia.	13 dB / 100 ft.	450 W	12"	PE34180-12	\$39.85	\$37.06	\$34.27
			24"	PE34180-24	\$46.95	\$43.66	\$40.38
			36"	PE34180-36	\$52.30	\$48.64	\$44.98
			48"	PE34180-48	\$57.45	\$53.43	\$49.41
			60"	PE34180-60	\$62.80	\$58.40	\$54.01
		Any	PE34180-XX	See Website for Pricing			
<b>50 Ohm, PE-SR405AL Coax</b>							
0.085" dia.	23 dB / 100 ft.	130 W	12"	PE34182-12	\$37.70	\$35.06	\$32.42
			24"	PE34182-24	\$44.35	\$41.25	\$38.14
			36"	PE34182-36	\$50.95	\$47.38	\$43.82
			48"	PE34182-48	\$57.60	\$53.57	\$49.54
			60"	PE34182-60	\$64.25	\$59.75	\$55.26
		Any	PE34182-XX	See Website for Pricing			
See website for the following cable(s)							
50 Ohm, RG401/U Coax				PE33003			

SMA MALE TO SMA MALE							
							
Cable Dia.	Atten.*	Max Power*	Length	Model No.	1-24	25-49	50-99
<b>50 Ohm, RG402/U Coax</b>							
0.141" dia.	13 dB / 100 ft.	650 W	12"	PE3492-12	\$37.70	\$35.06	\$32.42
			24"	PE3492-24	\$42.85	\$39.85	\$36.85
			36"	PE3492-36	\$48.30	\$44.92	\$41.54
			48"	PE3492-48	\$53.55	\$49.80	\$46.05
			60"	PE3492-60	\$58.80	\$54.68	\$50.57
		Any	PE3492-XX	See Website for Pricing			
<b>50 Ohm, RG405/U Coax</b>							
0.085" dia.	22 dB / 100 ft.	130 W	12"	PE3818-12	\$36.35	\$33.81	\$31.26
			24"	PE3818-24	\$41.60	\$38.69	\$35.78
			36"	PE3818-36	\$46.90	\$43.62	\$40.33
			48"	PE3818-48	\$52.15	\$48.50	\$44.85
			60"	PE3818-60	\$57.45	\$53.43	\$49.41
		Any	PE3818-XX	See Website for Pricing			

SMA MALE TO SMA MALE PUSH-ON							
							
Cable	Model No.						
Precision Flexible Cable Assemblies							
Please see precision section, page 6-29							
50 Ohm, 300 Series Coax				PE311			

SMA MALE TO SMA MALE QD							
							
Cable	Model No.						
Precision Flexible Cable Assemblies							
Please see precision section, page 6-29							
50 Ohm, 300 Series Coax				PE312			

SMA MALE TO SMA MALE RIGHT ANGLE							
							
Cable Dia.	Atten.*	Max Power*	Length	Model No.	1-24	25-49	50-99
Precision Flexible Cable Assemblies							
Please see precision section, page 6-29							
50 Ohm, 150 Series Coax				PE35418			
50 Ohm, 165 Non-Magnetic Series Coax				PE35420			
50 Ohm, 300 Series Coax				PE301			
Precision Formable Cable Assemblies							
Please see precision section, page 6-29							
50 Ohm, PE-SR402FL Coax				PE39425			
50 Ohm, PE-SR402FLJ Jacketed Coax				PE39439			
50 Ohm, PE-SR405FL Coax				PE39417			
50 Ohm, PE-SR405FLJ Jacketed Coax				PE39431			
Standard Flexible Cable Assemblies							
<b>50 Ohm, RG58C/U Coax</b>							
0.195" dia.	20 dB / 100 ft.	44 W	12"	PE3319-12	\$43.95	\$40.87	\$37.80
			24"	PE3319-24	\$44.40	\$41.29	\$38.18
			36"	PE3319-36	\$44.75	\$41.62	\$38.49
			48"	PE3319-48	\$45.15	\$41.99	\$38.83
			60"	PE3319-60	\$45.60	\$42.41	\$39.22
		Any	PE3319-XX	See Website for Pricing			

Cable Assemblies

\*Coax Performance at 1 GHz  
Notes: Cable assembly max frequency may be lower than connector or coax max frequency

Continued on Next Page



Continued from Previous Page

### SMA MALE TO SMA MALE RIGHT ANGLE



Cable Dia.	Atten.*	Max Power*	Length	Model No.	1-24	25-49	50-99
<b>50 Ohm, RG142B/U Coax</b>							
0.195" dia.	13 dB / 100 ft.	650 W	12"	PE3512-12	\$47.75	\$44.41	\$41.07
			24"	PE3512-24	\$50.50	\$46.97	\$43.43
			36"	PE3512-36	\$53.25	\$49.52	\$45.80
			48"	PE3512-48	\$56.00	\$52.08	\$48.16
			60"	PE3512-60	\$58.70	\$54.59	\$50.48
Any	PE3512-XX	See Website for Pricing					
<b>50 Ohm, RG174A/U Coax</b>							
0.100" dia.	31 dB / 100 ft.	16 W	12"	PE3420-12	\$45.00	\$41.85	\$38.70
			24"	PE3420-24	\$45.45	\$42.27	\$39.09
			36"	PE3420-36	\$45.85	\$42.64	\$39.43
			48"	PE3420-48	\$46.30	\$43.06	\$39.82
			60"	PE3420-60	\$46.75	\$43.48	\$40.21
Any	PE3420-XX	See Website for Pricing					
<b>See website for the following cable(s)</b>							
50 Ohm, RG178B/U Coax				PE3865			
95 Ohm, RG180B/U Twinax				PE3352			
<b>50 Ohm, RG188A/U Coax</b>							
0.110" dia.	30 dB / 100 ft.	160 W	12"	PE3510-12	\$46.25	\$43.01	\$39.78
			24"	PE3510-24	\$47.95	\$44.59	\$41.24
			36"	PE3510-36	\$49.65	\$46.17	\$42.70
			48"	PE3510-48	\$51.35	\$47.76	\$44.16
			60"	PE3510-60	\$53.05	\$49.34	\$45.62
Any	PE3510-XX	See Website for Pricing					
<b>See website for the following cable(s)</b>							
50 Ohm, RG188-DS Coax				PE3779			
<b>50 Ohm, RG223/U Coax</b>							
0.216" dia.	16.5 dB / 100 ft.	53 W	12"	PE3429-12	\$44.45	\$41.34	\$38.23
			24"	PE3429-24	\$45.75	\$42.55	\$39.35
			36"	PE3429-36	\$47.05	\$43.76	\$40.46
			48"	PE3429-48	\$48.45	\$45.06	\$41.67
			60"	PE3429-60	\$49.90	\$46.41	\$42.91
Any	PE3429-XX	See Website for Pricing					
<b>50 Ohm, RG316/U Coax</b>							
0.102" dia.	30 dB / 100 ft.	160 W	12"	PE3513-12	\$46.95	\$43.66	\$40.38
			24"	PE3513-24	\$49.35	\$45.90	\$42.44
			36"	PE3513-36	\$51.75	\$48.13	\$44.51
			48"	PE3513-48	\$54.15	\$50.36	\$46.57
			60"	PE3513-60	\$56.55	\$52.59	\$48.63
Any	PE3513-XX	See Website for Pricing					
<b>50 Ohm, RG316-DS Coax</b>							
0.114" dia.	30 dB / 100 ft.	160 W	12"	PE3344-12	\$47.65	\$44.31	\$40.98
			24"	PE3344-24	\$50.15	\$46.64	\$43.13
			36"	PE3344-36	\$52.60	\$48.92	\$45.24
			48"	PE3344-48	\$55.15	\$51.29	\$47.43
			60"	PE3344-60	\$57.60	\$53.57	\$49.54
Any	PE3344-XX	See Website for Pricing					
<b>50 Ohm, RG400/U Coax</b>							
0.195" dia.	13 dB / 100 ft.	650 W	12"	PE3003-12	\$47.75	\$44.41	\$41.07
			24"	PE3003-24	\$53.05	\$49.34	\$45.62
			36"	PE3003-36	\$58.50	\$54.41	\$50.31
			48"	PE3003-48	\$63.90	\$59.43	\$54.95
			60"	PE3003-60	\$69.35	\$64.50	\$59.64
Any	PE3003-XX	See Website for Pricing					
<b>See website for the following cable(s)</b>							
50 Ohm, PE-C195 Coax				PE36475			
50 Ohm, PE-C240 Coax				PE38624			
75 Ohm, RG179B/U Coax				PE3459			
<b>Standard Formable Cable Assemblies</b>							
<b>See website for the following cable(s)</b>							
50 Ohm, PE-SR401FL Coax				PE34202			

### SMA MALE TO SMA MALE RIGHT ANGLE



Cable Dia.	Atten.*	Max Power*	Length	Model No.	1-24	25-49	50-99
<b>50 Ohm, PE-SR402FL Coax</b>							
0.141" dia.	12 dB / 100 ft.	450 W	12"	PE3483-12	\$52.70	\$49.01	\$45.32
			24"	PE3483-24	\$58.65	\$54.54	\$50.44
			36"	PE3483-36	\$64.60	\$60.08	\$55.56
			48"	PE3483-48	\$70.60	\$65.66	\$60.72
			60"	PE3483-60	\$76.40	\$71.05	\$65.70
Any	PE3483-XX	See Website for Pricing					
<b>50 Ohm, PE-SR405FL Coax</b>							
0.085" dia.	22 dB / 100 ft.	130 W	12"	PE3958-12	\$54.70	\$50.87	\$47.04
			24"	PE3958-24	\$62.55	\$58.17	\$53.79
			36"	PE3958-36	\$67.70	\$62.96	\$58.22
			48"	PE3958-48	\$73.10	\$67.98	\$62.87
			60"	PE3958-60	\$78.30	\$72.82	\$67.34
Any	PE3958-XX	See Website for Pricing					
<b>Standard Semirigid Cable Assemblies</b>							
<b>See website for the following cable(s)</b>							
50 Ohm, PE-SR402AL Coax				PE34195			
50 Ohm, RG402/U Coax				PE3821			
50 Ohm, RG405/U Coax				PE3822			

### SMA MALE TO SMA FEMALE



Cable Dia.	Atten.*	Max Power*	Length	Model No.	1-24	25-49	50-99
<b>Precision Formable Cable Assemblies</b>							
<b>Please see precision section, page 6-29</b>							
50 Ohm, PE-SR402FL Coax				PE39426			
50 Ohm, PE-SR402FLJ Jacketed Coax				PE39440			
50 Ohm, PE-SR405FL Coax				PE39418			
50 Ohm, PE-SR405FLJ Jacketed Coax				PE39432			
<b>Standard Flexible Cable Assemblies</b>							
<b>50 Ohm, RG58C/U Coax</b>							
0.195" dia.	20 dB / 100 ft.	44 W	12"	PE3078-12	\$43.95	\$40.87	\$37.80
			24"	PE3078-24	\$44.40	\$41.29	\$38.18
			36"	PE3078-36	\$44.75	\$41.62	\$38.49
			48"	PE3078-48	\$45.15	\$41.99	\$38.83
			60"	PE3078-60	\$45.60	\$42.41	\$39.22
Any	PE3078-XX	See Website for Pricing					
<b>50 Ohm, RG142B/U Coax</b>							
0.195" dia.	13 dB / 100 ft.	650 W	12"	PE3611-12	\$47.75	\$44.41	\$41.07
			24"	PE3611-24	\$50.50	\$46.97	\$43.43
			36"	PE3611-36	\$53.25	\$49.52	\$45.80
			48"	PE3611-48	\$56.00	\$52.08	\$48.16
			60"	PE3611-60	\$58.70	\$54.59	\$50.48
Any	PE3611-XX	See Website for Pricing					
<b>See website for the following cable(s)</b>							
50 Ohm, RG174A/U Coax				PE3715			
50 Ohm, RG178B/U Coax				PE3056			
50 Ohm, RG188A/U Coax				PE3706			
<b>50 Ohm, RG223/U Coax</b>							
0.216" dia.	16.5 dB / 100 ft.	53 W	12"	PE3697-12	\$44.45	\$41.34	\$38.23
			24"	PE3697-24	\$45.75	\$42.55	\$39.35
			36"	PE3697-36	\$47.05	\$43.76	\$40.46
			48"	PE3697-48	\$48.45	\$45.06	\$41.67
			60"	PE3697-60	\$49.90	\$46.41	\$42.91
Any	PE3697-XX	See Website for Pricing					

Cable Assemblies

\*Coax Performance at 1 GHz  
Notes: Cable assembly max frequency may be lower than connector or coax max frequency

Continued on Next Page

ROHS & REACH COMPLIANT. CUSTOM-LENGTH CABLE ASSEMBLIES MAY BE ORDERED ON OUR WEBSITE.

Continued from Previous Page

### SMA MALE TO SMA FEMALE



Cable Dia.	Atten.*	Max Power*	Length	Model No.	1-24	25-49	50-99
<b>50 Ohm, RG316/U Coax</b>							
0.102" dia.	30 dB / 100 ft.	160 W	12"	PE3832-12	\$44.25	\$41.15	\$38.06
			24"	PE3832-24	\$46.15	\$42.92	\$39.69
			36"	PE3832-36	\$48.55	\$45.15	\$41.75
			48"	PE3832-48	\$50.95	\$47.38	\$43.82
			60"	PE3832-60	\$53.35	\$49.62	\$45.88
Any	PE3832-XX	See Website for Pricing					
<b>50 Ohm, RG316-DS Coax</b>							
0.114" dia.	30 dB / 100 ft.	160 W	12"	PE3171-12	\$47.65	\$44.31	\$40.98
			24"	PE3171-24	\$50.15	\$46.64	\$43.13
			36"	PE3171-36	\$52.60	\$48.92	\$45.24
			48"	PE3171-48	\$55.15	\$51.29	\$47.43
			60"	PE3171-60	\$57.60	\$53.57	\$49.54
Any	PE3171-XX	See Website for Pricing					
<b>50 Ohm, RG400/U Coax</b>							
0.195" dia.	13 dB / 100 ft.	650 W	12"	PE3864-12	\$47.75	\$44.41	\$41.07
			24"	PE3864-24	\$50.50	\$46.97	\$43.43
			36"	PE3864-36	\$53.25	\$49.52	\$45.80
			48"	PE3864-48	\$57.00	\$53.01	\$49.02
			60"	PE3864-60	\$62.40	\$58.03	\$53.66
Any	PE3864-XX	See Website for Pricing					
<b>See website for the following cable(s)</b>							
50 Ohm, PE-C240 Coax				PE38638			
75 Ohm, RG179B/U Coax				PE3102			
50 Ohm, PE-P195 Coax				PE3160			
<b>Standard Formable Cable Assemblies</b>							
<b>See website for the following cable(s)</b>							
50 Ohm, PE-SR401FL Coax				PE34233			
<b>50 Ohm, PE-SR402FL Coax</b>							
0.141" dia.	12 dB / 100 ft.	450 W	12"	PE3443-12	\$41.90	\$38.97	\$36.03
			24"	PE3443-24	\$47.85	\$44.50	\$41.15
			36"	PE3443-36	\$53.80	\$50.03	\$46.27
			48"	PE3443-48	\$59.75	\$55.57	\$51.39
			60"	PE3443-60	\$65.75	\$61.15	\$56.55
Any	PE3443-XX	See Website for Pricing					
<b>See website for the following cable(s)</b>							
50 Ohm, PE-SR405FL Coax				PE3651			
<b>Standard Semirigid Cable Assemblies</b>							
<b>See website for the following cable(s)</b>							
50 Ohm, PE-034SR Coax				PE34226			
50 Ohm, PE-047SR Coax				PE3188			
50 Ohm, PE-SR401AL Coax				PE34230			
50 Ohm, PE-SR402AL Coax				PE34235			
50 Ohm, PE-SR405AL Coax				PE34237			
<b>50 Ohm, RG402/U Coax</b>							
0.141" dia.	13 dB / 100 ft.	650 W	12"	PE3823-12	\$41.55	\$38.64	\$35.73
			24"	PE3823-24	\$47.15	\$43.85	\$40.55
			36"	PE3823-36	\$52.80	\$49.10	\$45.41
			48"	PE3823-48	\$58.40	\$54.31	\$50.22
			60"	PE3823-60	\$64.05	\$59.57	\$55.08
Any	PE3823-XX	See Website for Pricing					
<b>See website for the following cable(s)</b>							
50 Ohm, RG405/U Coax				PE3824			

The GR874 connector or General Radio Type 874, was invented by its namesake company, General Radio Corporation in the 1960's.

### SMA MALE TO SMA FEMALE BULKHEAD

SEE MOUNTING HOLE SECTION ON PAGE 246



Cable Dia.	Atten.*	Max Power*	Length	Model No.	1-24	25-49	50-99
<b>Precision Flexible Cable Assemblies</b>							
<b>Please see precision section, page 6-29</b>							
50 Ohm, 150 Series Coax				PE35475			
<b>Precision Formable Cable Assemblies</b>							
<b>Please see precision section, page 6-29</b>							
50 Ohm, PE-SR402FL Coax				PE39427			
50 Ohm, PE-SR402FLJ Jacketed Coax				PE39441			
50 Ohm, PE-SR405FL Coax				PE39419			
50 Ohm, PE-SR405FLJ Jacketed Coax				PE39433			
<b>Standard Flexible Cable Assemblies</b>							
<b>See website for the following cable(s)</b>							
50 Ohm, RG58C/U Coax				PE3956			
50 Ohm, RG142B/U Coax				PE3494			
<b>50 Ohm, RG174A/U Coax</b>							
0.100" dia.	31 dB / 100 ft.	16 W	12"	PE3184-12	\$46.55	\$43.29	\$40.03
			24"	PE3184-24	\$46.80	\$43.52	\$40.25
			36"	PE3184-36	\$47.05	\$43.76	\$40.46
			48"	PE3184-48	\$47.40	\$44.08	\$40.76
			60"	PE3184-60	\$47.65	\$44.31	\$40.98
Any	PE3184-XX	See Website for Pricing					
<b>See website for the following cable(s)</b>							
50 Ohm, RG178B/U Coax				PE3959			
<b>50 Ohm, RG188A/U Coax</b>							
0.110" dia.	30 dB / 100 ft.	160 W	12"	PE3051-12	\$46.90	\$43.62	\$40.33
			24"	PE3051-24	\$47.95	\$44.59	\$41.24
			36"	PE3051-36	\$48.90	\$45.48	\$42.05
			48"	PE3051-48	\$49.95	\$46.45	\$42.96
			60"	PE3051-60	\$50.85	\$47.29	\$43.73
Any	PE3051-XX	See Website for Pricing					
<b>50 Ohm, RG223/U Coax</b>							
0.216" dia.	16.5 dB / 100 ft.	53 W	12"	PE3553-12	\$47.05	\$43.76	\$40.46
			24"	PE3553-24	\$48.45	\$45.06	\$41.67
			36"	PE3553-36	\$49.90	\$46.41	\$42.91
			48"	PE3553-48	\$51.25	\$47.66	\$44.08
			60"	PE3553-60	\$52.55	\$48.87	\$45.19
Any	PE3553-XX	See Website for Pricing					
<b>50 Ohm, RG316/U Coax</b>							
0.102" dia.	30 dB / 100 ft.	160 W	12"	PE3835-12	\$46.90	\$43.62	\$40.33
			24"	PE3835-24	\$47.95	\$44.59	\$41.24
			36"	PE3835-36	\$48.90	\$45.48	\$42.05
			48"	PE3835-48	\$50.25	\$46.73	\$43.22
			60"	PE3835-60	\$52.65	\$48.96	\$45.28
Any	PE3835-XX	See Website for Pricing					
<b>See website for the following cable(s)</b>							
50 Ohm, RG316-DS Coax				PE3973			
50 Ohm, RG400/U Coax				PE3924			
50 Ohm, PE-C195 Coax				PE36417			
<b>75 Ohm, RG179B/U Coax</b>							
0.100" dia.	25 dB / 100 ft.	200 W	12"	PE3967-12	\$46.90	\$43.62	\$40.33
			24"	PE3967-24	\$47.95	\$44.59	\$41.24
			36"	PE3967-36	\$48.90	\$45.48	\$42.05
			48"	PE3967-48	\$49.95	\$46.45	\$42.96
			60"	PE3967-60	\$50.85	\$47.29	\$43.73
Any	PE3967-XX	See Website for Pricing					
<b>See website for the following cable(s)</b>							
50 Ohm, PE-P195 Coax				PE3799			
<b>Standard Formable Cable Assemblies</b>							
<b>See website for the following cable(s)</b>							
50 Ohm, PE-SR047FL Coax				PE34245			
50 Ohm, PE-SR401FL Coax				PE34249			

Cable Assemblies

\*Coax Performance at 1 GHz  
Notes: Cable assembly max frequency may be lower than connector or coax max frequency

Continued on Next Page

Continued from Previous Page

### SMA MALE TO SMA FEMALE BULKHEAD

SEE MOUNTING HOLE SECTION ON PAGE 246



Cable Dia.	Atten.*	Max Power*	Length	Model No.	1-24	25-49	50-99
<b>50 Ohm, PE-SR402FL Coax</b>							
0.141" dia.	12 dB / 100 ft.	450 W	12"	PE3468-12	\$42.60	\$39.62	\$36.64
			24"	PE3468-24	\$48.55	\$45.15	\$41.75
			36"	PE3468-36	\$54.50	\$50.69	\$46.87
			48"	PE3468-48	\$60.45	\$56.22	\$51.99
			60"	PE3468-60	\$66.40	\$61.75	\$57.10
Any	PE3468-XX	See Website for Pricing					
<b>50 Ohm, PE-SR405FL Coax</b>							
0.085" dia.	22 dB / 100 ft.	130 W	12"	PE3961-12	\$47.15	\$43.85	\$40.55
			24"	PE3961-24	\$55.40	\$51.52	\$47.64
			36"	PE3961-36	\$63.60	\$59.15	\$54.70
			48"	PE3961-48	\$71.85	\$66.82	\$61.79
			60"	PE3961-60	\$80.05	\$74.45	\$68.84
Any	PE3961-XX	See Website for Pricing					
<b>Standard Semirigid Cable Assemblies</b>							
<b>See website for the following cable(s)</b>							
50 Ohm, PE-047SR Coax				PE3531			
50 Ohm, PE-SR402AL Coax				PE34252			
50 Ohm, PE-SR405AL Coax				PE34254			
50 Ohm, RG401/U Coax				PE34256			
50 Ohm, RG402/U Coax				PE3825			
50 Ohm, RG405/U Coax				PE3826			

### SMA MALE TO REVERSE POLARITY SMA MALE



Cable	Model No.
<b>Standard Flexible Cable Assemblies</b>	
<b>See website for the following cable(s)</b>	
50 Ohm, RG58C/U Coax	PE34116
50 Ohm, RG142B/U Coax	PE34614
50 Ohm, RG174A/U Coax	PE34331
50 Ohm, RG223/U Coax	PE34398
50 Ohm, RG316/U Coax	PE35212

### SMA MALE RIGHT ANGLE TO SMA MALE RIGHT ANGLE



Cable Dia.	Atten.*	Max Power*	Length	Model No.	1-24	25-49	50-99
<b>Precision Flexible Cable Assemblies</b>							
<b>Please see precision section, page 6-29</b>							
50 Ohm, 150 Series Coax				PE35422			
50 Ohm, 165 Non-Magnetic Series Coax				PE35424			
<b>Precision Formable Cable Assemblies</b>							
<b>Please see precision section, page 6-29</b>							
50 Ohm, PE-SR402FL Coax				PE39424			
50 Ohm, PE-SR402FLJ Jacketed Coax				PE39438			
50 Ohm, PE-SR405FL Coax				PE39416			
50 Ohm, PE-SR405FLJ Jacketed Coax				PE39430			

### SMA MALE RIGHT ANGLE TO SMA MALE RIGHT ANGLE



Cable Dia.	Atten.*	Max Power*	Length	Model No.	1-24	25-49	50-99
<b>Standard Flexible Cable Assemblies</b>							
<b>50 Ohm, RG58C/U Coax</b>							
0.195" dia.	20 dB / 100 ft.	44 W	12"	PE3655-12	\$46.65	\$43.38	\$40.12
			24"	PE3655-24	\$47.00	\$43.71	\$40.42
			36"	PE3655-36	\$47.50	\$44.18	\$40.85
			48"	PE3655-48	\$47.95	\$44.59	\$41.24
			60"	PE3655-60	\$48.35	\$44.97	\$41.58
Any	PE3655-XX	See Website for Pricing					
<b>50 Ohm, RG142B/U Coax</b>							
0.195" dia.	13 dB / 100 ft.	650 W	12"	PE3514-12	\$50.50	\$46.97	\$43.43
			24"	PE3514-24	\$53.25	\$49.52	\$45.80
			36"	PE3514-36	\$56.00	\$52.08	\$48.16
			48"	PE3514-48	\$59.15	\$55.01	\$50.87
			60"	PE3514-60	\$63.30	\$58.87	\$54.44
Any	PE3514-XX	See Website for Pricing					
<b>50 Ohm, RG174A/U Coax</b>							
0.100" dia.	31 dB / 100 ft.	16 W	12"	PE3775-12	\$47.45	\$44.13	\$40.81
			24"	PE3775-24	\$47.85	\$44.50	\$41.15
			36"	PE3775-36	\$48.30	\$44.92	\$41.54
			48"	PE3775-48	\$48.75	\$45.34	\$41.93
			60"	PE3775-60	\$49.15	\$45.71	\$42.27
Any	PE3775-XX	See Website for Pricing					
<b>50 Ohm, RG178B/U Coax</b>							
0.750" dia.	45 dB / 100 ft.	78 W	12"	PE3876-12	\$64.70	\$60.17	\$55.64
			24"	PE3876-24	\$65.65	\$61.05	\$56.46
			36"	PE3876-36	\$66.65	\$61.98	\$57.32
			48"	PE3876-48	\$67.65	\$62.91	\$58.18
			60"	PE3876-60	\$68.65	\$63.84	\$59.04
Any	PE3876-XX	See Website for Pricing					
<b>See website for the following cable(s)</b>							
95 Ohm, RG180B/U Twinax				PE3141			
<b>50 Ohm, RG188A/U Coax</b>							
0.110" dia.	30 dB / 100 ft.	160 W	12"	PE3511-12	\$48.70	\$45.29	\$41.88
			24"	PE3511-24	\$50.40	\$46.87	\$43.34
			36"	PE3511-36	\$52.10	\$48.45	\$44.81
			48"	PE3511-48	\$53.75	\$49.99	\$46.23
			60"	PE3511-60	\$55.45	\$51.57	\$47.69
Any	PE3511-XX	See Website for Pricing					
<b>50 Ohm, RG188-DS Coax</b>							
0.122" dia.	30 dB / 100 ft.	160 W	12"	PE3347-12	\$50.40	\$46.87	\$43.34
			24"	PE3347-24	\$52.85	\$49.15	\$45.45
			36"	PE3347-36	\$55.40	\$51.52	\$47.64
			48"	PE3347-48	\$57.85	\$53.80	\$49.75
			60"	PE3347-60	\$60.30	\$56.08	\$51.86
Any	PE3347-XX	See Website for Pricing					
<b>50 Ohm, RG223/U Coax</b>							
0.216" dia.	16.5 dB / 100 ft.	53 W	12"	PE3428-12	\$47.05	\$43.76	\$40.46
			24"	PE3428-24	\$48.45	\$45.06	\$41.67
			36"	PE3428-36	\$49.90	\$46.41	\$42.91
			48"	PE3428-48	\$51.45	\$47.85	\$44.25
			60"	PE3428-60	\$53.65	\$49.89	\$46.14
Any	PE3428-XX	See Website for Pricing					
<b>50 Ohm, RG316/U Coax</b>							
0.102" dia.	30 dB / 100 ft.	160 W	12"	PE3515-12	\$49.40	\$45.94	\$42.48
			24"	PE3515-24	\$51.80	\$48.17	\$44.55
			36"	PE3515-36	\$54.20	\$50.41	\$46.61
			48"	PE3515-48	\$56.55	\$52.59	\$48.63
			60"	PE3515-60	\$58.95	\$54.82	\$50.70
Any	PE3515-XX	See Website for Pricing					

Cable Assemblies

\*Coax Performance at 1 GHz  
Notes: Cable assembly max frequency may be lower than connector or coax max frequency

Continued on Next Page

ROHS & REACH COMPLIANT. CUSTOM-LENGTH CABLE ASSEMBLIES MAY BE ORDERED ON OUR WEBSITE.

Continued from Previous Page

### SMA MALE RIGHT ANGLE TO SMA MALE RIGHT ANGLE



Cable Dia.	Atten.*	Max Power*	Length	Model No.	1-24	25-49	50-99
<b>50 Ohm, RG316-DS Coax</b>							
0.114" dia.	30 dB / 100 ft.	160 W	12"	PE3987-12	\$50.40	\$46.87	\$43.34
			24"	PE3987-24	\$52.85	\$49.15	\$45.45
			36"	PE3987-36	\$55.40	\$51.52	\$47.64
			48"	PE3987-48	\$57.85	\$53.80	\$49.75
			60"	PE3987-60	\$60.30	\$56.08	\$51.86
			Any	PE3987-XX	See Website for Pricing		
<b>50 Ohm, RG400/U Coax</b>							
0.195" dia.	13 dB / 100 ft.	650 W	12"	PE3713-12	\$52.45	\$48.78	\$45.11
			24"	PE3713-24	\$57.85	\$53.80	\$49.75
			36"	PE3713-36	\$63.30	\$58.87	\$54.44
			48"	PE3713-48	\$68.75	\$63.94	\$59.13
			60"	PE3713-60	\$74.15	\$68.96	\$63.77
			Any	PE3713-XX	See Website for Pricing		
<b>See website for the following cable(s)</b>							
50 Ohm, PE-C195 Coax				PE35347			
50 Ohm, PE-C240 Coax				PE38920			
75 Ohm, RG59B/U Coax				PE3380			
<b>75 Ohm, RG179B/U Coax</b>							
0.100" dia.	25 dB / 100 ft.	200 W	12"	PE3858-12	\$48.90	\$45.48	\$42.05
			24"	PE3858-24	\$50.75	\$47.20	\$43.65
			36"	PE3858-36	\$52.65	\$48.96	\$45.28
			48"	PE3858-48	\$54.55	\$50.73	\$46.91
			60"	PE3858-60	\$56.40	\$52.45	\$48.50
			Any	PE3858-XX	See Website for Pricing		
<b>Standard Formable Cable Assemblies</b>							
<b>50 Ohm, PE-SR402FL Coax</b>							
0.141" dia.	12 dB / 100 ft.	450 W	12"	PE3417-12	\$71.20	\$66.22	\$61.23
			24"	PE3417-24	\$77.20	\$71.80	\$66.39
			36"	PE3417-36	\$83.15	\$77.33	\$71.51
			48"	PE3417-48	\$89.10	\$82.86	\$76.63
			60"	PE3417-60	\$95.05	\$88.40	\$81.74
			Any	PE3417-XX	See Website for Pricing		
<b>50 Ohm, PE-SR405FL Coax</b>							
0.085" dia.	22 dB / 100 ft.	130 W	12"	PE3646-12	\$74.55	\$69.33	\$64.11
			24"	PE3646-24	\$82.80	\$77.00	\$71.21
			36"	PE3646-36	\$91.00	\$84.63	\$78.26
			48"	PE3646-48	\$96.40	\$89.65	\$82.90
			60"	PE3646-60	\$101.65	\$94.53	\$87.42
			Any	PE3646-XX	See Website for Pricing		
<b>Standard Semirigid Cable Assemblies</b>							
<b>See website for the following cable(s)</b>							
50 Ohm, PE-SR402AL Coax				PE34208			
50 Ohm, PE-SR405AL Coax				PE34213			
50 Ohm, RG402/U Coax				PE3819			
50 Ohm, RG405/U Coax				PE3820			

### SMA MALE RIGHT ANGLE TO SMA FEMALE BULKHEAD

SEE MOUNTING HOLE SECTION ON PAGE 246



Cable Dia.	Atten.*	Max Power*	Length	Model No.	1-24	25-49	50-99
<b>Precision Flexible Cable Assemblies</b>							
<b>Please see precision section, page 6-29</b>							
50 Ohm, 150 Series Coax				PE35421			
<b>Precision Formable Cable Assemblies</b>							
<b>Please see precision section, page 6-29</b>							
50 Ohm, PE-SR402FL Coax				PE39428			
50 Ohm, PE-SR402FLJ Jacketed Coax				PE39442			

### SMA MALE RIGHT ANGLE TO SMA FEMALE BULKHEAD

SEE MOUNTING HOLE SECTION ON PAGE 246



Cable Dia.	Atten.*	Max Power*	Length	Model No.	1-24	25-49	50-99
<b>50 Ohm, PE-SR405FL Coax</b>							
50 Ohm, PE-SR405FL Coax				PE39420			
50 Ohm, PE-SR405FLJ Jacketed Coax				PE39434			
<b>Standard Flexible Cable Assemblies</b>							
<b>See website for the following cable(s)</b>							
50 Ohm, RG58C/U Coax				PE3156			
50 Ohm, RG142B/U Coax				PE3759			
50 Ohm, RG174A/U Coax				PE3149			
50 Ohm, RG178B/U Coax				PE3152			
50 Ohm, RG188A/U Coax				PE3050			
50 Ohm, RG188-DS Coax				PE34179			
<b>50 Ohm, RG223/U Coax</b>							
0.216" dia.	16.5 dB / 100 ft.	53 W	12"	PE3800-12	\$47.05	\$43.76	\$40.46
			24"	PE3800-24	\$48.45	\$45.06	\$41.67
			36"	PE3800-36	\$49.90	\$46.41	\$42.91
			48"	PE3800-48	\$51.25	\$47.66	\$44.08
			60"	PE3800-60	\$52.55	\$48.87	\$45.19
			Any	PE3800-XX	See Website for Pricing		
<b>50 Ohm, RG316/U Coax</b>							
0.102" dia.	30 dB / 100 ft.	160 W	12"	PE3836-12	\$49.90	\$46.41	\$42.91
			24"	PE3836-24	\$52.30	\$48.64	\$44.98
			36"	PE3836-36	\$54.70	\$50.87	\$47.04
			48"	PE3836-48	\$57.10	\$53.10	\$49.11
			60"	PE3836-60	\$59.45	\$55.29	\$51.13
			Any	PE3836-XX	See Website for Pricing		
<b>See website for the following cable(s)</b>							
50 Ohm, RG316-DS Coax				PE34061			
50 Ohm, RG400/U Coax				PE34192			
<b>Standard Formable Cable Assemblies</b>							
<b>See website for the following cable(s)</b>							
50 Ohm, PE-SR402FL Coax				PE34299			
50 Ohm, PE-SR405FL Coax				PE34313			
<b>Standard Semirigid Cable Assemblies</b>							
<b>See website for the following cable(s)</b>							
50 Ohm, PE-SR405AL Coax				PE34311			

### SMA FEMALE TO SMA FEMALE



Cable	Model No.
<b>Standard Flexible Cable Assemblies</b>	
<b>See website for the following cable(s)</b>	
50 Ohm, RG58C/U Coax	PE33547
50 Ohm, RG174A/U Coax	PE33120
50 Ohm, RG223/U Coax	PE33254
50 Ohm, RG316/U Coax	PE33047
<b>Standard Formable Cable Assemblies</b>	
<b>See website for the following cable(s)</b>	
50 Ohm, PE-SR047FL Coax	PE34833
50 Ohm, PE-SR402FL Coax	PE33964
50 Ohm, PE-SR405FL Coax	PE34292
<b>Standard Semirigid Cable Assemblies</b>	
<b>See website for the following cable(s)</b>	
50 Ohm, PE-020SR Coax	PE34917
50 Ohm, PE-034SR Coax	PE34405
50 Ohm, PE-047SR Coax	PE3758
50 Ohm, PE-SR047AL Coax	PE34835
50 Ohm, PE-SR402AL Coax	PE34836
50 Ohm, PE-SR405AL Coax	PE34834
50 Ohm, RG401/U Coax	PE3521

Cable Assemblies

\*Coax Performance at 1 GHz  
Notes: Cable assembly max frequency may be lower than connector or coax max frequency

Continued on Next Page



Continued from Previous Page

### SMA FEMALE TO SMA FEMALE



Cable Model No.

50 Ohm, RG402/U Coax	PE3931	1
50 Ohm, RG405/U Coax	PE3109	2

### SMA FEMALE BULKHEAD TO SMA FEMALE BULKHEAD

SEE MOUNTING HOLE SECTION ON PAGE 246



Cable Model No.

Standard Flexible Cable Assemblies

See website for the following cable(s)

50 Ohm, RG58C/U Coax	PE35404	3
50 Ohm, RG174A/U Coax	PE33382	4
50 Ohm, RG316/U Coax	PE33158	5
50 Ohm, RG316-DS Coax	PE38184	6
50 Ohm, RG400/U Coax	PE36228	7

Standard Formable Cable Assemblies

See website for the following cable(s)

50 Ohm, PE-SR047FL Coax	PE34709	8
50 Ohm, PE-SR402FL Coax	PE33864	9
50 Ohm, PE-SR405FL Coax	PE34070	10

Standard Semirigid Cable Assemblies

See website for the following cable(s)

50 Ohm, PE-020SR Coax	PE3932	11
50 Ohm, PE-034SR Coax	PE3520	12
50 Ohm, PE-047SR Coax	PE33789	13
50 Ohm, PE-SR405AL Coax	PE34071	14
50 Ohm, RG402/U Coax	PE33518	15
50 Ohm, RG405/U Coax	PE33176	16

### SMA FEMALE 2 HOLE PANEL TO SMA FEMALE 2 HOLE PANEL



Cable Model No.

Standard Formable Cable Assemblies

See website for the following cable(s)

50 Ohm, PE-SR402FL Coax	PE35108	17
-------------------------	---------	----

Standard Semirigid Cable Assemblies

See website for the following cable(s)

50 Ohm, PE-047SR Coax	PE35064	18
50 Ohm, RG405/U Coax	PE33191	19

### SMA FEMALE 4 HOLE PANEL TO SMA FEMALE 4 HOLE PANEL



Cable Model No.

Standard Formable Cable Assemblies

See website for the following cable(s)

50 Ohm, PE-SR047FL Coax	PE35112	20
50 Ohm, PE-SR402FL Coax	PE35110	21
50 Ohm, PE-SR405FL Coax	PE35116	22

Standard Semirigid Cable Assemblies

See website for the following cable(s)

50 Ohm, PE-047SR Coax	PE35118	23
50 Ohm, RG402/U Coax	PE33502	24

### SMA FEMALE 4 HOLE PANEL TO SMA FEMALE 4 HOLE PANEL



Cable Model No.

50 Ohm, RG405/U Coax	PE3223	25
----------------------	--------	----

### SMA MALE TO 2.4MM MALE



Cable Model No.

Standard Semirigid Cable Assemblies

See website for the following cable(s)

50 Ohm, RG405/U Coax	PE35666	26
----------------------	---------	----

### SMA MALE TO SSMA MALE



Cable Model No.

Standard Flexible Cable Assemblies

See website for the following cable(s)

50 Ohm, RG174A/U Coax	PE35430	27
50 Ohm, RG178B/U Coax	PE3058	28
50 Ohm, RG316/U Coax	PE3669	29

### SMA MALE TO N MALE



Cable Dia.	Atten.*	Max Power*	Length	Model No.	1-24	25-49	50-99
------------	---------	------------	--------	-----------	------	-------	-------

Precision Flexible Cable Assemblies

Please see precision section, page 6-29

50 Ohm, 150 Series Coax	PE33231	30
50 Ohm, 165 Non-Magnetic Series Coax	PE33233	31
50 Ohm, 300 Series Coax	PE304	32

Standard Flexible Cable Assemblies

See website for the following cable(s)

52 Ohm, RG8A/U Coax	PE3323	33
53.5 Ohm, RG55B/U Coax	PE3654	34

0.195" dia.	20 dB / 100 ft.	44 W	12"	PE3662-12	\$33.85	\$31.48	\$29.11
			24"	PE3662-24	\$34.40	\$31.99	\$29.58
			36"	PE3662-36	\$34.90	\$32.46	\$30.01
			48"	PE3662-48	\$35.45	\$32.97	\$30.49
			60"	PE3662-60	\$36.00	\$33.48	\$30.96
Any	PE3662-XX	See Website for Pricing					

0.195" dia.	13 dB / 100 ft.	650 W	12"	PE3568-12	\$34.80	\$32.36	\$29.93
			24"	PE3568-24	\$38.95	\$36.22	\$33.50
			36"	PE3568-36	\$43.10	\$40.08	\$37.07
			48"	PE3568-48	\$47.20	\$43.90	\$40.59
			60"	PE3568-60	\$51.35	\$47.76	\$44.16
Any	PE3568-XX	See Website for Pricing					

0.100" dia.	31 dB / 100 ft.	16 W	12"	PE3291-12	\$38.70	\$35.99	\$33.28
			24"	PE3291-24	\$39.10	\$36.36	\$33.63
			36"	PE3291-36	\$39.55	\$36.78	\$34.01
			48"	PE3291-48	\$40.00	\$37.20	\$34.40
			60"	PE3291-60	\$40.40	\$37.57	\$34.74
Any	PE3291-XX	See Website for Pricing					

Cable Assemblies

\*Coax Performance at 1 GHz  
Notes: Cable assembly max frequency may be lower than connector or coax max frequency

Continued on Next Page

ROHS & REACH COMPLIANT. CUSTOM-LENGTH CABLE ASSEMBLIES MAY BE ORDERED ON OUR WEBSITE.

Continued from Previous Page

SMA MALE TO N MALE							
							
Cable Dia.	Atten.*	Max Power*	Length	Model No.	1-24	25-49	50-99
<b>See website for the following cable(s)</b>							
50 Ohm, RG178B/U Coax				PE3321			
50 Ohm, RG188A/U Coax				PE3911			
<b>50 Ohm, RG214/U Coax</b>							
0.425" dia.	9 dB / 100 ft.	190 W	12"	PE3422-12	\$95.25	\$88.58	\$81.92
			24"	PE3422-24	\$101.00	\$93.93	\$86.86
			36"	PE3422-36	\$106.75	\$99.28	\$91.81
			48"	PE3422-48	\$112.50	\$104.63	\$96.75
			60"	PE3422-60	\$118.25	\$109.97	\$101.70
Any			PE3422-XX	See Website for Pricing			
<b>50 Ohm, RG223/U Coax</b>							
0.216" dia.	16.5 dB / 100 ft.	53 W	12"	PE3519-12	\$32.85	\$30.55	\$28.25
			24"	PE3519-24	\$35.10	\$32.64	\$30.19
			36"	PE3519-36	\$37.30	\$34.69	\$32.08
			48"	PE3519-48	\$39.50	\$36.74	\$33.97
			60"	PE3519-60	\$41.70	\$38.78	\$35.86
Any			PE3519-XX	See Website for Pricing			
<b>50 Ohm, RG316/U Coax</b>							
0.102" dia.	30 dB / 100 ft.	160 W	12"	PE3234-12	\$40.65	\$37.80	\$34.96
			24"	PE3234-24	\$43.05	\$40.04	\$37.02
			36"	PE3234-36	\$45.45	\$42.27	\$39.09
			48"	PE3234-48	\$47.80	\$44.45	\$41.11
			60"	PE3234-60	\$50.20	\$46.69	\$43.17
Any			PE3234-XX	See Website for Pricing			
<b>50 Ohm, RG316-DS Coax</b>							
0.114" dia.	30 dB / 100 ft.	160 W	12"	PE3957-12	\$42.35	\$39.39	\$36.42
			24"	PE3957-24	\$44.80	\$41.66	\$38.53
			36"	PE3957-36	\$47.25	\$43.94	\$40.64
			48"	PE3957-48	\$49.80	\$46.31	\$42.83
			60"	PE3957-60	\$52.25	\$48.59	\$44.94
Any			PE3957-XX	See Website for Pricing			
<b>See website for the following cable(s)</b>							
50 Ohm, RG393/U Coax				PE3302			
<b>50 Ohm, RG400/U Coax</b>							
0.195" dia.	13 dB / 100 ft.	650 W	12"	PE3614-12	\$40.50	\$37.67	\$34.83
			24"	PE3614-24	\$45.95	\$42.73	\$39.52
			36"	PE3614-36	\$51.35	\$47.76	\$44.16
			48"	PE3614-48	\$56.80	\$52.82	\$48.85
			60"	PE3614-60	\$62.20	\$57.85	\$53.49
Any			PE3614-XX	See Website for Pricing			
<b>See website for the following cable(s)</b>							
50 Ohm, PE-C195 Coax				PE35981			
<b>50 Ohm, PE-C240 Coax</b>							
0.240" dia.	8 dB / 100 ft.	250 W	12"	PE38645-12	\$42.35	\$39.39	\$36.42
			24"	PE38645-24	\$44.70	\$41.57	\$38.44
			36"	PE38645-36	\$47.05	\$43.76	\$40.46
			48"	PE38645-48	\$49.35	\$45.90	\$42.44
			60"	PE38645-60	\$51.70	\$48.08	\$44.46
Any			PE38645-XX	See Website for Pricing			
<b>50 Ohm, PE-P195 Coax</b>							
0.195" dia.	12.5 dB / 100 ft.	650 W	12"	PE3318-12	\$54.60	\$50.78	\$46.96
			24"	PE3318-24	\$58.30	\$54.22	\$50.14
			36"	PE3318-36	\$62.05	\$57.71	\$53.36
			48"	PE3318-48	\$65.75	\$61.15	\$56.55
			60"	PE3318-60	\$69.45	\$64.59	\$59.73
Any			PE3318-XX	See Website for Pricing			
<b>Standard Formable Cable Assemblies</b>							
<b>See website for the following cable(s)</b>							
50 Ohm, PE-SR047FL Coax				PE34268			
50 Ohm, PE-SR401FL Coax				PE34263			

SMA MALE TO N MALE							
							
Cable Dia.	Atten.*	Max Power*	Length	Model No.	1-24	25-49	50-99
<b>50 Ohm, PE-SR402FL Coax</b>							
0.141" dia.	12 dB / 100 ft.	450 W	12"	PE3448-12	\$52.40	\$48.73	\$45.06
			24"	PE3448-24	\$56.10	\$52.17	\$48.25
			36"	PE3448-36	\$61.40	\$57.10	\$52.80
			48"	PE3448-48	\$67.35	\$62.64	\$57.92
			60"	PE3448-60	\$73.30	\$68.17	\$63.04
Any			PE3448-XX	See Website for Pricing			
<b>See website for the following cable(s)</b>							
50 Ohm, PE-SR405FL Coax				PE3657			
<b>Standard Semirigid Cable Assemblies</b>							
<b>See website for the following cable(s)</b>							
50 Ohm, PE-SR402AL Coax				PE34265			
50 Ohm, PE-SR405AL Coax				PE34270			
50 Ohm, RG401/U Coax				PE33001			
<b>50 Ohm, RG402/U Coax</b>							
0.141" dia.	13 dB / 100 ft.	650 W	12"	PE3887-12	\$49.15	\$45.71	\$42.27
			24"	PE3887-24	\$54.75	\$50.92	\$47.09
			36"	PE3887-36	\$60.40	\$56.17	\$51.94
			48"	PE3887-48	\$66.00	\$61.38	\$56.76
			60"	PE3887-60	\$71.60	\$66.59	\$61.58
Any			PE3887-XX	See Website for Pricing			
<b>See website for the following cable(s)</b>							
50 Ohm, RG405/U Coax				PE3828			

SMA MALE TO N FEMALE BULKHEAD							
SEE MOUNTING HOLE SECTION ON PAGE 246							
							
Cable Dia.	Atten.*	Max Power*	Length	Model No.	1-24	25-49	50-99
<b>Precision Flexible Cable Assemblies</b>							
<b>Please see precision section, page 6-29</b>							
50 Ohm, 150 Series Coax				PE35954			
50 Ohm, 165 Non-Magnetic Series Coax				PE35958			
<b>Precision Formable Cable Assemblies</b>							
<b>Please see precision section, page 6-29</b>							
50 Ohm, PE-SR402FL Coax				PE39455			
50 Ohm, PE-SR402FLJ Jacketed Coax				PE39469			
<b>Please see precision section, page 6-29</b>							
50 Ohm, PE-SR405FL Coax				PE39447			
50 Ohm, PE-SR405FLJ Jacketed Coax				PE39461			
<b>Standard Flexible Cable Assemblies</b>							
<b>Please see precision section, page 6-29</b>							
53.5 Ohm, RG55B/U Coax				PE34169			
<b>See website for the following cable(s)</b>							
50 Ohm, RG58C/U Coax				PE3013			
<b>50 Ohm, RG142B/U Coax</b>							
0.195" dia.	13 dB / 100 ft.	650 W	12"	PE3345-12	\$50.50	\$46.97	\$43.43
			24"	PE3345-24	\$53.25	\$49.52	\$45.80
			36"	PE3345-36	\$56.00	\$52.08	\$48.16
			48"	PE3345-48	\$58.70	\$54.59	\$50.48
			60"	PE3345-60	\$61.45	\$57.15	\$52.85
Any			PE3345-XX	See Website for Pricing			
<b>See website for the following cable(s)</b>							
50 Ohm, RG174A/U Coax				PE34171			
50 Ohm, RG178B/U Coax				PE34174			
50 Ohm, RG214/U Coax				PE33481			

Cable Assemblies

\*Coax Performance at 1 GHz  
Notes: Cable assembly max frequency may be lower than connector or coax max frequency

Continued on Next Page

Continued from Previous Page

### SMA MALE TO N FEMALE BULKHEAD

SEE MOUNTING HOLE SECTION ON PAGE 246



Cable Dia.	Atten.*	Max Power*	Length	Model No.	1-24	25-49	50-99
<b>50 Ohm, RG223/U Coax</b>							
0.216" dia.	16.5 dB / 100 ft.	53 W	12"	PE3193-12	\$47.05	\$43.76	\$40.46
			24"	PE3193-24	\$48.45	\$45.06	\$41.67
			36"	PE3193-36	\$49.90	\$46.41	\$42.91
			48"	PE3193-48	\$51.25	\$47.66	\$44.08
			60"	PE3193-60	\$52.55	\$48.87	\$45.19
			Any	PE3193-XX	See Website for Pricing		
<b>50 Ohm, RG316/U Coax</b>							
0.102" dia.	30 dB / 100 ft.	160 W	12"	PE33555-12	\$48.70	\$45.29	\$41.88
			24"	PE33555-24	\$51.10	\$47.52	\$43.95
			36"	PE33555-36	\$53.50	\$49.76	\$46.01
			48"	PE33555-48	\$55.85	\$51.94	\$48.03
			60"	PE33555-60	\$58.25	\$54.17	\$50.10
			Any	PE33555-XX	See Website for Pricing		
<b>See website for the following cable(s)</b>							
50 Ohm, RG316-DS Coax				PE33929			
<b>50 Ohm, RG400/U Coax</b>							
0.195" dia.	13 dB / 100 ft.	650 W	12"	PE33117-12	\$50.50	\$46.97	\$43.43
			24"	PE33117-24	\$53.25	\$49.52	\$45.80
			36"	PE33117-36	\$56.00	\$52.08	\$48.16
			48"	PE33117-48	\$59.75	\$55.57	\$51.39
			60"	PE33117-60	\$65.15	\$60.59	\$56.03
			Any	PE33117-XX	See Website for Pricing		
<b>See website for the following cable(s)</b>							
50 Ohm, PE-P195 Coax				PE34178			
<b>Standard Formable Cable Assemblies</b>							
<b>See website for the following cable(s)</b>							
50 Ohm, PE-SR401FL Coax				PE34163			
<b>50 Ohm, PE-SR402FL Coax</b>							
0.141" dia.	12 dB / 100 ft.	450 W	12"	PE33996-12	\$87.90	\$81.75	\$75.59
			24"	PE33996-24	\$91.60	\$85.19	\$78.78
			36"	PE33996-36	\$95.35	\$88.68	\$82.00
			48"	PE33996-48	\$99.10	\$92.16	\$85.23
			60"	PE33996-60	\$102.75	\$95.56	\$88.37
			Any	PE33996-XX	See Website for Pricing		
<b>See website for the following cable(s)</b>							
50 Ohm, PE-SR405FL Coax				PE33844			
<b>Standard Semirigid Cable Assemblies</b>							
<b>See website for the following cable(s)</b>							
50 Ohm, RG402/U Coax				PE3769			
50 Ohm, RG405/U Coax				PE3367			

### SMA MALE TO TNC MALE



Cable Dia.	Atten.*	Max Power*	Length	Model No.	1-24	25-49	50-99
<b>Precision Flexible Cable Assemblies</b>							
<b>Please see precision section, page 6-29</b>							
50 Ohm, 150 Series Coax				PE35419			
50 Ohm, 300 Series Coax				PE308			
<b>Standard Flexible Cable Assemblies</b>							
<b>50 Ohm, RG58C/U Coax</b>							
0.195" dia.	20 dB / 100 ft.	44 W	12"	PE3154-12	\$32.75	\$30.46	\$28.17
			24"	PE3154-24	\$33.20	\$30.88	\$28.55
			36"	PE3154-36	\$33.65	\$31.29	\$28.94
			48"	PE3154-48	\$34.05	\$31.67	\$29.28
			60"	PE3154-60	\$34.45	\$32.04	\$29.63
			Any	PE3154-XX	See Website for Pricing		

### SMA MALE TO TNC MALE



Cable Dia.	Atten.*	Max Power*	Length	Model No.	1-24	25-49	50-99
<b>50 Ohm, RG142B/U Coax</b>							
0.195" dia.	13 dB / 100 ft.	650 W	12"	PE3664-12	\$33.00	\$30.69	\$28.38
			24"	PE3664-24	\$37.15	\$34.55	\$31.95
			36"	PE3664-36	\$41.30	\$38.41	\$35.52
			48"	PE3664-48	\$45.45	\$42.27	\$39.09
			60"	PE3664-60	\$49.60	\$46.13	\$42.66
			Any	PE3664-XX	See Website for Pricing		
<b>50 Ohm, RG174A/U Coax</b>							
0.100" dia.	31 dB / 100 ft.	16 W	12"	PE3178-12	\$41.10	\$38.22	\$35.35
			24"	PE3178-24	\$41.55	\$38.64	\$35.73
			36"	PE3178-36	\$42.00	\$39.06	\$36.12
			48"	PE3178-48	\$42.40	\$39.43	\$36.46
			60"	PE3178-60	\$42.85	\$39.85	\$36.85
			Any	PE3178-XX	See Website for Pricing		
<b>See website for the following cable(s)</b>							
50 Ohm, RG188A/U Coax				PE33361			
50 Ohm, RG213/U Coax				PE33673			
<b>50 Ohm, RG214/U Coax</b>							
0.425" dia.	9 dB / 100 ft.	190 W	12"	PE3176-12	\$103.15	\$95.93	\$88.71
			24"	PE3176-24	\$108.90	\$101.28	\$93.65
			36"	PE3176-36	\$114.65	\$106.62	\$98.60
			48"	PE3176-48	\$120.40	\$111.97	\$103.54
			60"	PE3176-60	\$126.15	\$117.32	\$108.49
			Any	PE3176-XX	See Website for Pricing		
<b>50 Ohm, RG223/U Coax</b>							
0.216" dia.	16.5 dB / 100 ft.	53 W	12"	PE3535-12	\$32.75	\$30.46	\$28.17
			24"	PE3535-24	\$34.15	\$31.76	\$29.37
			36"	PE3535-36	\$35.55	\$33.06	\$30.57
			48"	PE3535-48	\$37.70	\$35.06	\$32.42
			60"	PE3535-60	\$39.95	\$37.15	\$34.36
			Any	PE3535-XX	See Website for Pricing		
<b>50 Ohm, RG316/U Coax</b>							
0.102" dia.	30 dB / 100 ft.	160 W	12"	PE3174-12	\$43.10	\$40.08	\$37.07
			24"	PE3174-24	\$45.45	\$42.27	\$39.09
			36"	PE3174-36	\$47.85	\$44.50	\$41.15
			48"	PE3174-48	\$50.25	\$46.73	\$43.22
			60"	PE3174-60	\$52.65	\$48.96	\$45.28
			Any	PE3174-XX	See Website for Pricing		
<b>See website for the following cable(s)</b>							
50 Ohm, RG316-DS Coax				PE34246			
50 Ohm, RG393/U Coax				PE34253			
<b>50 Ohm, RG400/U Coax</b>							
0.195" dia.	13 dB / 100 ft.	650 W	12"	PE33948-12	\$38.70	\$35.99	\$33.28
			24"	PE33948-24	\$44.15	\$41.06	\$37.97
			36"	PE33948-36	\$49.60	\$46.13	\$42.66
			48"	PE33948-48	\$55.00	\$51.15	\$47.30
			60"	PE33948-60	\$60.45	\$56.22	\$51.99
			Any	PE33948-XX	See Website for Pricing		
<b>See website for the following cable(s)</b>							
50 Ohm, PE-C195 Coax				PE36058			
50 Ohm, PE-C240 Coax				PE38642			
75 Ohm, RG59B/U Coax				PE36848			
<b>Standard Formable Cable Assemblies</b>							
<b>See website for the following cable(s)</b>							
50 Ohm, PE-SR402FL Coax				PE33928			
<b>Standard Semirigid Cable Assemblies</b>							
<b>See website for the following cable(s)</b>							
50 Ohm, PE-SR402AL Coax				PE34406			
50 Ohm, PE-SR405AL Coax				PE34414			

Cable Assemblies

\*Coax Performance at 1 GHz  
Notes: Cable assembly max frequency may be lower than connector or coax max frequency

### SMA MALE TO TNC MALE RIGHT ANGLE



Cable	Model No.
Precision Flexible Cable Assemblies	
<b>Please see precision section, page 6-29</b>	
50 Ohm, 300 Series Coax	PE309

### SMA MALE TO TNC FEMALE BULKHEAD

SEE MOUNTING HOLE SECTION ON PAGE 246



Cable	Model No.
Precision Formable Cable Assemblies	
<b>Please see precision section, page 6-29</b>	
50 Ohm, PE-SR402FL Coax	PE39483
50 Ohm, PE-SR402FLJ Jacketed Coax	PE39497
50 Ohm, PE-SR405FL Coax	PE39475
50 Ohm, PE-SR405FLJ Jacketed Coax	PE39489

### SMA MALE TO REVERSE POLARITY TNC MALE



Cable	Model No.
Standard Flexible Cable Assemblies	
<b>See website for the following cable(s)</b>	
50 Ohm, RG58C/U Coax	PE34853
50 Ohm, RG142B/U Coax	PE34854
50 Ohm, RG223/U Coax	PE34397
50 Ohm, RG316/U Coax	PE34396
50 Ohm, RG400/U Coax	PE35246
50 Ohm, PE-C195 Coax	PE37120

### SMA MALE TO SMC PLUG



Cable	Model No.
Standard Flexible Cable Assemblies	
<b>See website for the following cable(s)</b>	
50 Ohm, RG58C/U Coax	PE3210
50 Ohm, RG174A/U Coax	PE3944
50 Ohm, RG178B/U Coax	PE3561
50 Ohm, RG188-DS Coax	PE34458
50 Ohm, RG316/U Coax	PE3809
50 Ohm, RG316-DS Coax	PE34456
50 Ohm, RG400/U Coax	PE34454

### SMA MALE TO QMA MALE



Cable	Model No.
Standard Flexible Cable Assemblies	
<b>See website for the following cable(s)</b>	
50 Ohm, RG58C/U Coax	PE38275

### SMA MALE TO QMA MALE



Cable Dia.	Atten.*	Max Power*	Length	Model No.	1-24	25-49	50-99
<b>50 Ohm, RG316/U Coax</b>							
0.102" dia.	30 dB / 100 ft.	160 W	12"	PE38273-12	\$42.90	\$39.90	\$36.89
			24"	PE38273-24	\$45.25	\$42.08	\$38.92
			36"	PE38273-36	\$47.65	\$44.31	\$40.98
			48"	PE38273-48	\$50.05	\$46.55	\$43.04
			60"	PE38273-60	\$52.45	\$48.78	\$45.11
Any	PE38273-XX	See Website for Pricing					
<b>See website for the following cable(s)</b>							
				50 Ohm, RG316-DS Coax	PE38274		
				50 Ohm, PE-C195 Coax	PE38116		

### SMA MALE TO SMP FEMALE



Cable Dia.	Atten.*	Max Power*	Length	Model No.	1-24	25-49	50-99
Standard Formable Cable Assemblies							
<b>50 Ohm, PE-SR047FL Coax</b>							
0.047" dia.	40 dB / 100 ft.	32 W	12"	PE36164-12	\$65.95	\$61.33	\$56.72
			24"	PE36164-24	\$71.60	\$66.59	\$61.58
			36"	PE36164-36	\$77.25	\$71.84	\$66.44
			48"	PE36164-48	\$82.95	\$77.14	\$71.34
			60"	PE36164-60	\$88.60	\$82.40	\$76.20
Any	PE36164-XX	See Website for Pricing					
<b>50 Ohm, PE-SR405FL Coax</b>							
0.085" dia.	22 dB / 100 ft.	130 W	12"	PE36168-12	\$60.30	\$56.08	\$51.86
			24"	PE36168-24	\$68.50	\$63.71	\$58.91
			36"	PE36168-36	\$76.75	\$71.38	\$66.01
			48"	PE36168-48	\$84.95	\$79.00	\$73.06
			60"	PE36168-60	\$93.20	\$86.68	\$80.15
Any	PE36168-XX	See Website for Pricing					
Standard Semirigid Cable Assemblies							
<b>See website for the following cable(s)</b>							
				50 Ohm, PE-047SR Coax	PE36162		
				50 Ohm, RG405/U Coax	PE36166		

### SMA MALE TO UMCX PLUG RIGHT ANGLE



Cable Dia.	Atten.*	Max Power*	Length	Model No.	1-24	25-49	50-99
Standard Flexible Cable Assemblies							
<b>50 Ohm, RG178B/U Coax</b>							
0.750" dia.	45 dB / 100 ft.	78 W	3"	PE38881-3	\$49.55	\$46.08	\$42.61
			6"	PE38881-6	\$49.55	\$46.08	\$42.61
			9"	PE38881-9	\$49.55	\$46.08	\$42.61
			12"	PE38881-12	\$50.25	\$46.73	\$43.22
			18"	PE38881-18	\$52.45	\$48.78	\$45.11
24"	PE38881-24	\$54.65	\$50.82	\$47.00			
Any	PE38881-XX	See Website for Pricing					

The SMA connector or "Sub-Miniature version A" was invented in the 1960's.

\*Coax Performance at 1 GHz  
Notes: Cable assembly max frequency may be lower than connector or coax max frequency





Cable Assemblies

\*Coax Performance at 1 GHz  
Notes: Cable assembly max frequency may be lower than connector or coax max frequency

SMA MALE TO MMCX PLUG							
							
Cable Dia.	Atten.*	Max Power*	Length	Model No.	1-24	25-49	50-99
Standard Flexible Cable Assemblies							
50 Ohm, RG174A/U Coax							
0.100" dia.	31 dB / 100 ft.	16 W	12"	PE34069-12	\$38.10	\$35.43	\$32.77
			24"	PE34069-24	\$38.50	\$35.81	\$33.11
			36"	PE34069-36	\$38.95	\$36.22	\$33.50
			48"	PE34069-48	\$39.35	\$36.60	\$33.84
			60"	PE34069-60	\$39.80	\$37.01	\$34.23
			Any	PE34069-XX	See Website for Pricing		
50 Ohm, RG178B/U Coax							
0.750" dia.	45 dB / 100 ft.	78 W	12"	PE34374-12	\$40.35	\$37.53	\$34.70
			24"	PE34374-24	\$41.10	\$38.22	\$35.35
			36"	PE34374-36	\$41.80	\$38.87	\$35.95
			48"	PE34374-48	\$42.55	\$39.57	\$36.59
			60"	PE34374-60	\$43.25	\$40.22	\$37.20
Any	PE34374-XX	See Website for Pricing					
See website for the following cable(s)							
50 Ohm, RG188A/U Coax				PE34887			
50 Ohm, RG316/U Coax							
0.102" dia.	30 dB / 100 ft.	160 W	12"	PE34122-12	\$40.05	\$37.25	\$34.44
			24"	PE34122-24	\$42.45	\$39.48	\$36.51
			36"	PE34122-36	\$44.80	\$41.66	\$38.53
			48"	PE34122-48	\$47.20	\$43.90	\$40.59
			60"	PE34122-60	\$49.60	\$46.13	\$42.66
Any	PE34122-XX	See Website for Pricing					

SMA MALE TO MMCX PLUG RIGHT ANGLE							
							
Cable Dia.	Atten.*	Max Power*	Length	Model No.	1-24	25-49	50-99
Standard Flexible Cable Assemblies							
50 Ohm, RG178B/U Coax							
0.750" dia.	45 dB / 100 ft.	78 W	12"	PE34777-12	\$46.10	\$42.87	\$39.65
			24"	PE34777-24	\$46.85	\$43.57	\$40.29
			36"	PE34777-36	\$47.60	\$44.27	\$40.94
			48"	PE34777-48	\$48.30	\$44.92	\$41.54
			60"	PE34777-60	\$49.05	\$45.62	\$42.18
			Any	PE34777-XX	See Website for Pricing		

SMA MALE TO SMB PLUG							
							
Cable Dia.	Atten.*	Max Power*	Length	Model No.	1-24	25-49	50-99
Standard Flexible Cable Assemblies							
See website for the following cable(s)							
50 Ohm, PE-B100 Coax				PE34455			
50 Ohm, RG58C/U Coax							
0.195" dia.	20 dB / 100 ft.	44 W	12"	PE3172-12	\$37.15	\$34.55	\$31.95
			24"	PE3172-24	\$37.50	\$34.88	\$32.25
			36"	PE3172-36	\$37.90	\$35.25	\$32.59
			48"	PE3172-48	\$38.35	\$35.67	\$32.98
			60"	PE3172-60	\$38.85	\$36.13	\$33.41
Any	PE3172-XX	See Website for Pricing					
See website for the following cable(s)							
50 Ohm, RG142B/U Coax				PE3181			

SMA MALE TO SMB PLUG							
							
Cable Dia.	Atten.*	Max Power*	Length	Model No.	1-24	25-49	50-99
Standard Flexible Cable Assemblies							
50 Ohm, RG174A/U Coax							
0.100" dia.	31 dB / 100 ft.	16 W	12"	PE3908-12	\$37.10	\$34.50	\$31.91
			24"	PE3908-24	\$37.30	\$34.69	\$32.08
			36"	PE3908-36	\$37.55	\$34.92	\$32.29
			48"	PE3908-48	\$37.80	\$35.15	\$32.51
			60"	PE3908-60	\$38.15	\$35.48	\$32.81
			Any	PE3908-XX	See Website for Pricing		
See website for the following cable(s)							
50 Ohm, RG178B/U Coax				PE3548			
50 Ohm, RG188A/U Coax							
0.110" dia.	30 dB / 100 ft.	160 W	12"	PE3755-12	\$37.40	\$34.78	\$32.16
			24"	PE3755-24	\$38.40	\$35.71	\$33.02
			36"	PE3755-36	\$39.65	\$36.87	\$34.10
			48"	PE3755-48	\$41.35	\$38.46	\$35.56
			60"	PE3755-60	\$43.05	\$40.04	\$37.02
			Any	PE3755-XX	See Website for Pricing		
See website for the following cable(s)							
50 Ohm, RG188-DS Coax				PE3722			
50 Ohm, RG223/U Coax							
0.216" dia.	16.5 dB / 100 ft.	53 W	12"	PE3187-12	\$37.55	\$34.92	\$32.29
			24"	PE3187-24	\$38.95	\$36.22	\$33.50
			36"	PE3187-36	\$40.25	\$37.43	\$34.62
			48"	PE3187-48	\$41.60	\$38.69	\$35.78
			60"	PE3187-60	\$43.35	\$40.32	\$37.28
			Any	PE3187-XX	See Website for Pricing		
50 Ohm, RG316/U Coax							
0.102" dia.	30 dB / 100 ft.	160 W	12"	PE3810-12	\$37.40	\$34.78	\$32.16
			24"	PE3810-24	\$39.40	\$36.64	\$33.88
			36"	PE3810-36	\$41.75	\$38.83	\$35.91
			48"	PE3810-48	\$44.15	\$41.06	\$37.97
			60"	PE3810-60	\$46.55	\$43.29	\$40.03
			Any	PE3810-XX	See Website for Pricing		
50 Ohm, RG316-DS Coax							
0.114" dia.	30 dB / 100 ft.	160 W	12"	PE33657-12	\$40.90	\$38.04	\$35.17
			24"	PE33657-24	\$43.35	\$40.32	\$37.28
			36"	PE33657-36	\$45.80	\$42.59	\$39.39
			48"	PE33657-48	\$48.30	\$44.92	\$41.54
			60"	PE33657-60	\$50.75	\$47.20	\$43.65
			Any	PE33657-XX	See Website for Pricing		
See website for the following cable(s)							
50 Ohm, RG400/U Coax				PE34452			
Standard Formable Cable Assemblies							
See website for the following cable(s)							
50 Ohm, PE-SR405FL Coax				PE34764			

SMA MALE TO FAKRA PLUG							
SEE FAKRA SPECIFICATION ON PAGE 243							
							
Cable	Model No.						
Standard Flexible Cable Assemblies							
See website for the following cable(s)							
50 Ohm, RG174A/U Coax	PE39197A						
	PE39197B						
	PE39197C						
	PE39197D						
	PE39197H						
	PE39197I						
	PE39197K						
	PE39197Z						

Continued on Next Page

Continued from Previous Page

SMA MALE TO FAKRA PLUG	
SEE FAKRA SPECIFICATION ON PAGE 243	
	
Cable	Model No.
50 Ohm, RG316/U Coax	PE39343A
	PE39343B
	PE39343C
	PE39343D
	PE39343H
	PE39343I
50 Ohm, PE-C100 Coax	PE39343K
	PE39343Z
	PE39342A
	PE39342B
	PE39342C
	PE39342D
PE39342H	
PE39342I	
PE39342K	
PE39342Z	

SMA MALE TO FAKRA JACK	
SEE FAKRA SPECIFICATION ON PAGE 243	
	
Cable	Model No.
Standard Flexible Cable Assemblies	
See website for the following cable(s)	
50 Ohm, RG174A/U Coax	PE39199A
	PE39199B
	PE39199C
	PE39199D
	PE39199H
	PE39199I
50 Ohm, RG316/U Coax	PE39199K
	PE39199Z
	PE39348A
	PE39348B
	PE39348C
	PE39348D
50 Ohm, PE-C100 Coax	PE39348H
	PE39348I
	PE39348K
	PE39348Z
	PE39347A
	PE39347B
PE39347C	
PE39347D	
PE39347H	
PE39347I	
PE39347K	
PE39347Z	

SMA MALE TO MC-CARD PLUG	
	
Cable	Model No.
Standard Flexible Cable Assemblies	
See website for the following cable(s)	
50 Ohm, RG316/U Coax	PE36108

SMA MALE TO BNC MALE								
								
Cable Dia.	Atten. *	Max Power *	Length	Model No.	1-24	25-49	50-99	
Standard Flexible Cable Assemblies								
See website for the following cable(s)								
53.5 Ohm, RG55B/U Coax					PE3479		7	
50 Ohm, RG58C/U Coax								
0.195" dia.	20 dB / 100 ft.	44 W	12"	PE3615-12	\$28.05	\$26.09	\$24.12	8
			24"	PE3615-24	\$28.60	\$26.60	\$24.60	
			36"	PE3615-36	\$29.10	\$27.06	\$25.03	
			48"	PE3615-48	\$29.65	\$27.57	\$25.50	
			60"	PE3615-60	\$30.20	\$28.09	\$25.97	
Any	PE3615-XX		See Website for Pricing					
See website for the following cable(s)								
93 Ohm, RG71B/U Coax					PE38700		9	
50 Ohm, RG142B/U Coax								
0.195" dia.	13 dB / 100 ft.	650 W	12"	PE3696-12	\$32.75	\$30.46	\$28.17	10
			24"	PE3696-24	\$35.55	\$33.06	\$30.57	
			36"	PE3696-36	\$38.25	\$35.57	\$32.90	
			48"	PE3696-48	\$41.00	\$38.13	\$35.26	
			60"	PE3696-60	\$44.35	\$41.25	\$38.14	
Any	PE3696-XX		See Website for Pricing					
50 Ohm, RG174A/U Coax								
0.100" dia.	31 dB / 100 ft.	16 W	12"	PE3745-12	\$33.50	\$31.16	\$28.81	11
			24"	PE3745-24	\$33.95	\$31.57	\$29.20	
			36"	PE3745-36	\$34.40	\$31.99	\$29.58	
			48"	PE3745-48	\$34.80	\$32.36	\$29.93	
			60"	PE3745-60	\$35.25	\$32.78	\$30.32	
Any	PE3745-XX		See Website for Pricing					
50 Ohm, RG178B/U Coax								
0.750" dia.	45 dB / 100 ft.	78 W	12"	PE33258-12	\$53.25	\$49.52	\$45.80	12
			24"	PE33258-24	\$54.30	\$50.50	\$46.70	
			36"	PE33258-36	\$55.25	\$51.38	\$47.52	
			48"	PE33258-48	\$56.20	\$52.27	\$48.33	
			60"	PE33258-60	\$57.25	\$53.24	\$49.24	
Any	PE33258-XX		See Website for Pricing					
50 Ohm, RG188A/U Coax								
0.110" dia.	30 dB / 100 ft.	160 W	12"	PE3885-12	\$34.75	\$32.32	\$29.89	13
			24"	PE3885-24	\$36.45	\$33.90	\$31.35	
			36"	PE3885-36	\$38.15	\$35.48	\$32.81	
			48"	PE3885-48	\$39.85	\$37.06	\$34.27	
			60"	PE3885-60	\$41.55	\$38.64	\$35.73	
Any	PE3885-XX		See Website for Pricing					
See website for the following cable(s)								
50 Ohm, RG196A/U Coax					PE33523		14	
50 Ohm, RG213/U Coax					PE36661		15	
50 Ohm, RG214/U Coax					PE33519		16	
50 Ohm, RG223/U Coax								
0.216" dia.	16.5 dB / 100 ft.	53 W	12"	PE3562-12	\$31.40	\$29.20	\$27.00	17
			24"	PE3562-24	\$32.75	\$30.46	\$28.17	
			36"	PE3562-36	\$34.15	\$31.76	\$29.37	
			48"	PE3562-48	\$35.55	\$33.06	\$30.57	
			60"	PE3562-60	\$36.85	\$34.27	\$31.69	
Any	PE3562-XX		See Website for Pricing					
50 Ohm, RG316/U Coax								
0.102" dia.	30 dB / 100 ft.	160 W	12"	PE3658-12	\$35.50	\$33.02	\$30.53	18
			24"	PE3658-24	\$37.85	\$35.20	\$32.55	
			36"	PE3658-36	\$40.25	\$37.43	\$34.62	
			48"	PE3658-48	\$42.65	\$39.66	\$36.68	
			60"	PE3658-60	\$45.05	\$41.90	\$38.74	
Any	PE3658-XX		See Website for Pricing					
See website for the following cable(s)								
50 Ohm, RG316-DS Coax					PE33559		19	
50 Ohm, RG393/U Coax					PE33521		20	

Cable Assemblies

\*Coax Performance at 1 GHz  
Notes: Cable assembly max frequency may be lower than connector or coax max frequency

Continued on Next Page

Continued from Previous Page

### SMA MALE TO BNC MALE



Cable Dia.	Atten.*	Max Power*	Length	Model No.	1-24	25-49	50-99
<b>50 Ohm, RG400/U Coax</b>							
0.195" dia.	13 dB / 100 ft.	650 W	12"	PE3613-12	\$33.50	\$31.16	\$28.81
			24"	PE3613-24	\$38.95	\$36.22	\$33.50
			36"	PE3613-36	\$44.35	\$41.25	\$38.14
			48"	PE3613-48	\$49.80	\$46.31	\$42.83
			60"	PE3613-60	\$55.25	\$51.38	\$47.52
Any	PE3613-XX	See Website for Pricing					
<b>75 Ohm, RG59B/U Coax</b>							
0.242" dia.	11.5 dB / 100 ft.	77 W	12"	PE3539-12	\$38.25	\$35.57	\$32.90
			24"	PE3539-24	\$38.70	\$35.99	\$33.28
			36"	PE3539-36	\$39.10	\$36.36	\$33.63
			48"	PE3539-48	\$39.50	\$36.74	\$33.97
			60"	PE3539-60	\$39.85	\$37.06	\$34.27
Any	PE3539-XX	See Website for Pricing					
<b>75 Ohm, RG179B/U Coax</b>							
0.100" dia.	25 dB / 100 ft.	200 W	12"	PE3626-12	\$34.95	\$32.50	\$30.06
			24"	PE3626-24	\$36.85	\$34.27	\$31.69
			36"	PE3626-36	\$38.75	\$36.04	\$33.33
			48"	PE3626-48	\$40.60	\$37.76	\$34.92
			60"	PE3626-60	\$42.50	\$39.53	\$36.55
Any	PE3626-XX	See Website for Pricing					
<b>See website for the following cable(s)</b>							
50 Ohm, PE-P195 Coax				PE33989			
<b>Standard Formable Cable Assemblies</b>							
<b>See website for the following cable(s)</b>							
50 Ohm, PE-SR402FL Coax				PE34008			
50 Ohm, PE-SR405FL Coax				PE35109			

### SMA MALE TO NMO MOUNT CONNECTOR

NMO MOUNT REQUIRES 3/4" HOLE, 1 1/8"-18 THREAD AND INSTALLS FROM ABOVE.



Cable	Model No.
<b>Standard Flexible Cable Assemblies</b>	
<b>See website for the following cable(s)</b>	
50 Ohm, RG58C/U Coax	PE37840

### SMA MALE RIGHT ANGLE TO N FEMALE BULKHEAD

SEE MOUNTING HOLE SECTION ON PAGE 246



Cable	Model No.
<b>Precision Formable Cable Assemblies</b>	
<b>Please see precision section, page 6-29</b>	
50 Ohm, PE-SR402FL Coax	PE39456
50 Ohm, PE-SR402FLJ Jacketed Coax	PE39470
50 Ohm, PE-SR405FL Coax	PE39448
50 Ohm, PE-SR405FLJ Jacketed Coax	PE39462

The Type N connector was invented in the 1940s by Paul Neill.

### SMA MALE RIGHT ANGLE TO TNC FEMALE BULKHEAD

SEE MOUNTING HOLE SECTION ON PAGE 246



Cable	Model No.
<b>Precision Formable Cable Assemblies</b>	
<b>Please see precision section, page 6-29</b>	
50 Ohm, PE-SR402FL Coax	PE39484
50 Ohm, PE-SR402FLJ Jacketed Coax	PE39498
50 Ohm, PE-SR405FL Coax	PE39476
50 Ohm, PE-SR405FLJ Jacketed Coax	PE39490

### SMA MALE RIGHT ANGLE TO BNC MALE



Cable Dia.	Atten.*	Max Power*	Length	Model No.	1-24	25-49	50-99
<b>Standard Flexible Cable Assemblies</b>							
<b>50 Ohm, RG142B/U Coax</b>							
0.195" dia.	13 dB / 100 ft.	650 W	12"	PE3780-12	\$45.05	\$41.90	\$38.74
			24"	PE3780-24	\$47.75	\$44.41	\$41.07
			36"	PE3780-36	\$50.50	\$46.97	\$43.43
			48"	PE3780-48	\$53.25	\$49.52	\$45.80
			60"	PE3780-60	\$56.00	\$52.08	\$48.16
Any	PE3780-XX	See Website for Pricing					
<b>50 Ohm, RG174A/U Coax</b>							
0.100" dia.	31 dB / 100 ft.	16 W	12"	PE3886-12	\$42.50	\$39.53	\$36.55
			24"	PE3886-24	\$42.75	\$39.76	\$36.77
			36"	PE3886-36	\$43.00	\$39.99	\$36.98
			48"	PE3886-48	\$43.25	\$40.22	\$37.20
			60"	PE3886-60	\$43.55	\$40.50	\$37.45
Any	PE3886-XX	See Website for Pricing					
<b>See website for the following cable(s)</b>							
50 Ohm, RG178B/U Coax				PE33257			
<b>50 Ohm, RG188A/U Coax</b>							
0.110" dia.	30 dB / 100 ft.	160 W	12"	PE3756-12	\$41.60	\$38.69	\$35.78
			24"	PE3756-24	\$43.30	\$40.27	\$37.24
			36"	PE3756-36	\$45.00	\$41.85	\$38.70
			48"	PE3756-48	\$46.70	\$43.43	\$40.16
			60"	PE3756-60	\$48.35	\$44.97	\$41.58
Any	PE3756-XX	See Website for Pricing					
<b>50 Ohm, RG223/U Coax</b>							
0.216" dia.	16.5 dB / 100 ft.	53 W	12"	PE3733-12	\$44.45	\$41.34	\$38.23
			24"	PE3733-24	\$45.75	\$42.55	\$39.35
			36"	PE3733-36	\$47.05	\$43.76	\$40.46
			48"	PE3733-48	\$48.45	\$45.06	\$41.67
			60"	PE3733-60	\$49.90	\$46.41	\$42.91
Any	PE3733-XX	See Website for Pricing					
<b>50 Ohm, RG316/U Coax</b>							
0.102" dia.	30 dB / 100 ft.	160 W	12"	PE3811-12	\$42.30	\$39.34	\$36.38
			24"	PE3811-24	\$44.70	\$41.57	\$38.44
			36"	PE3811-36	\$47.10	\$43.80	\$40.51
			48"	PE3811-48	\$49.50	\$46.04	\$42.57
			60"	PE3811-60	\$51.85	\$48.22	\$44.59
Any	PE3811-XX	See Website for Pricing					
<b>See website for the following cable(s)</b>							
50 Ohm, RG316-DS Coax				PE33600			
<b>50 Ohm, RG400/U Coax</b>							
0.195" dia.	13 dB / 100 ft.	650 W	12"	PE3642-12	\$45.05	\$41.90	\$38.74
			24"	PE3642-24	\$48.15	\$44.78	\$41.41
			36"	PE3642-36	\$53.60	\$49.85	\$46.10
			48"	PE3642-48	\$59.00	\$54.87	\$50.74
			60"	PE3642-60	\$64.45	\$59.94	\$55.43
Any	PE3642-XX	See Website for Pricing					

Cable Assemblies

\*Coax Performance at 1 GHz  
Notes: Cable assembly max frequency may be lower than connector or coax max frequency

Continued on Next Page

ROHS & REACH COMPLIANT. CUSTOM-LENGTH CABLE ASSEMBLIES MAY BE ORDERED ON OUR WEBSITE.

Continued from Previous Page

### SMA MALE RIGHT ANGLE TO BNC MALE



Cable Dia.	Atten.*	Max Power*	Length	Model No.	1-24	25-49	50-99
<b>See website for the following cable(s)</b>							
50 Ohm, PE-C195 Coax				PE38093			1

### SMA FEMALE TO N MALE



Cable	Model No.
<b>Precision Flexible Cable Assemblies</b>	
<b>Please see precision section, page 6-29</b>	
50 Ohm, 300 Series Coax	PE306

### SMA FEMALE TO QMA MALE



Cable	Model No.
<b>Standard Flexible Cable Assemblies</b>	
<b>See website for the following cable(s)</b>	
50 Ohm, RG58C/U Coax	PE38277
50 Ohm, RG316/U Coax	PE38276
50 Ohm, RG316-DS Coax	PE38052
50 Ohm, PE-C195 Coax	PE38278

### SMA FEMALE TO FAKRA PLUG

SEE FAKRA SPECIFICATION ON PAGE 243



Cable	Model No.
<b>Standard Flexible Cable Assemblies</b>	
<b>See website for the following cable(s)</b>	
50 Ohm, RG174A/U Coax	PE39345A
	PE39345B
	PE39345C
	PE39345D
	PE39345H
	PE39345I
50 Ohm, RG316/U Coax	PE39345K
	PE39345Z
	PE39346A
	PE39346B
	PE39346C
	PE39346D
	PE39346H
	PE39346I
50 Ohm, PE-C100 Coax	PE39346K
	PE39346Z
	PE39344A
	PE39344B
	PE39344C
	PE39344D
	PE39344H
	PE39344I

### SMA FEMALE TO FAKRA JACK

SEE FAKRA SPECIFICATION ON PAGE 243



Cable	Model No.
<b>Standard Flexible Cable Assemblies</b>	
<b>See website for the following cable(s)</b>	
50 Ohm, RG174A/U Coax	PE39350A
	PE39350B
	PE39350C
	PE39350D
	PE39350H
	PE39350I
50 Ohm, RG316/U Coax	PE39350K
	PE39350Z
	PE39351A
	PE39351B
	PE39351C
	PE39351D
50 Ohm, PE-C100 Coax	PE39351H
	PE39351I
	PE39351K
	PE39351Z
	PE39349A
	PE39349B
	PE39349C
	PE39349D
PE39349H	
PE39349I	
PE39349K	
PE39349Z	

### SMA FEMALE TO NMO MOUNT CONNECTOR

NMO MOUNT REQUIRES 3/4" HOLE, 1 1/8"-18 THREAD AND INSTALLS FROM ABOVE.



Cable	Model No.
<b>Standard Flexible Cable Assemblies</b>	
<b>See website for the following cable(s)</b>	
50 Ohm, RG58C/U Coax	PE37841

### SMA FEMALE BULKHEAD TO UMCX PLUG

SEE MOUNTING HOLE SECTION ON PAGE 246



Cable Dia.	Atten.*	Max Power*	Length	Model No.	1-24	25-49	50-99
<b>Standard Flexible Cable Assemblies</b>							
<b>50 Ohm, 1.13mm Coax</b>							
0.750" dia.	45 dB / 100 ft.	78 W	6"	PE38297-6	\$16.72	\$15.55	\$14.38
			12"	PE38297-12	\$17.38	\$16.16	\$14.95
			18"	PE38297-18	\$18.39	\$17.10	\$15.82
			Any	PE38297-XX	See Website for Pricing		

A GPS satellite circles the Earth roughly once every 12 hours.

Cable Assemblies

\*Coax Performance at 1 GHz  
Notes: Cable assembly max frequency may be lower than connector or coax max frequency

Continued on Next Page



Cable Assemblies

### SMA FEMALE BULKHEAD TO UMCX PLUG RIGHT ANGLE

SEE MOUNTING HOLE SECTION ON PAGE 246



Cable Model No.

Standard Flexible Cable Assemblies

See website for the following cable(s)	
50 Ohm, RG178B/U Coax	PE38299

1

### SMA FEMALE BULKHEAD TO MMCX PLUG

SEE MOUNTING HOLE SECTION ON PAGE 246



Cable Dia. Atten.\* Max Power\* Length Model No. 1-24 25-49 50-99

Precision Formable Cable Assemblies

Please see precision section, page 6-29	
50 Ohm, PE-SR405FL Coax	PE39422
50 Ohm, PE-SR405FLJ Jacketed Coax	PE39436

2

3

Standard Flexible Cable Assemblies

50 Ohm, RG316/U Coax							
0.102" dia.	30 dB / 100 ft.	160 W	12"	PE35575-12	\$43.00	\$39.99	\$36.98
			24"	PE35575-24	\$45.35	\$42.18	\$39.00
			36"	PE35575-36	\$47.75	\$44.41	\$41.07
			48"	PE35575-48	\$50.15	\$46.64	\$43.13
			60"	PE35575-60	\$52.55	\$48.87	\$45.19
			Any	PE35575-XX	See Website for Pricing		

4

### SMA FEMALE BULKHEAD TO MMCX PLUG RIGHT ANGLE

SEE MOUNTING HOLE SECTION ON PAGE 246



Cable Dia. Atten.\* Max Power\* Length Model No. 1-24 25-49 50-99

Standard Flexible Cable Assemblies

50 Ohm, RG316/U Coax							
0.102" dia.	30 dB / 100 ft.	160 W	12"	PE34686-12	\$50.40	\$46.87	\$43.34
			24"	PE34686-24	\$52.80	\$49.10	\$45.41
			36"	PE34686-36	\$55.20	\$51.34	\$47.47
			48"	PE34686-48	\$57.60	\$53.57	\$49.54
			60"	PE34686-60	\$60.00	\$55.80	\$51.60
			Any	PE34686-XX	See Website for Pricing		

5

### SMA FEMALE BULKHEAD TO 75 OHM MCX JACK

SEE MOUNTING HOLE SECTION ON PAGE 246



Cable Model No.

Precision Formable Cable Assemblies

Please see precision section, page 6-29	
50 Ohm, PE-SR405FL Coax	PE39421
50 Ohm, PE-SR405FLJ Jacketed Coax	PE39435

6

7

Japan's "Tokyo Skytree" is the world's tallest broadcasting tower at 2,080 ft tall.

### REVERSE POLARITY SMA MALE TO N MALE



Cable Dia. Atten.\* Max Power\* Length Model No. 1-24 25-49 50-99

Standard Flexible Cable Assemblies

50 Ohm, RG58C/U Coax							
0.195" dia.	20 dB / 100 ft.	44 W	12"	PE34727-12	\$42.50	\$39.53	\$36.55
			24"	PE34727-24	\$43.00	\$39.99	\$36.98
			36"	PE34727-36	\$43.55	\$40.50	\$37.45
			48"	PE34727-48	\$44.10	\$41.01	\$37.93
			60"	PE34727-60	\$44.65	\$41.52	\$38.40
			Any	PE34727-XX	See Website for Pricing		

8

50 Ohm, RG142B/U Coax							
0.195" dia.	13 dB / 100 ft.	650 W	12"	PE34361-12	\$39.75	\$36.97	\$34.19
			24"	PE34361-24	\$43.90	\$40.83	\$37.75
			36"	PE34361-36	\$48.05	\$44.69	\$41.32
			48"	PE34361-48	\$52.20	\$48.55	\$44.89
			60"	PE34361-60	\$56.30	\$52.36	\$48.42
			Any	PE34361-XX	See Website for Pricing		

9

50 Ohm, RG174A/U Coax							
0.100" dia.	31 dB / 100 ft.	16 W	12"	PE35221-12	\$41.00	\$38.13	\$35.26
			24"	PE35221-24	\$41.25	\$38.36	\$35.48
			36"	PE35221-36	\$41.50	\$38.60	\$35.69
			48"	PE35221-48	\$41.80	\$38.87	\$35.95
			60"	PE35221-60	\$42.25	\$39.29	\$36.34
			Any	PE35221-XX	See Website for Pricing		

10

See website for the following cable(s)	
50 Ohm, RG223/U Coax	PE35227
50 Ohm, RG400/U Coax	PE34323
50 Ohm, PE-C195 Coax	PE36072

11

12

13

### REVERSE POLARITY SMA MALE TO TNC MALE



Cable Dia. Atten.\* Max Power\* Length Model No. 1-24 25-49 50-99

Standard Flexible Cable Assemblies

50 Ohm, RG58C/U Coax							
0.195" dia.	20 dB / 100 ft.	44 W	12"	PE35214-12	\$39.95	\$37.15	\$34.36
			24"	PE35214-24	\$40.50	\$37.67	\$34.83
			36"	PE35214-36	\$41.05	\$38.18	\$35.30
			48"	PE35214-48	\$41.55	\$38.64	\$35.73
			60"	PE35214-60	\$42.10	\$39.15	\$36.21
			Any	PE35214-XX	See Website for Pricing		

14

See website for the following cable(s)	
50 Ohm, RG142B/U Coax	PE35216

15

### REVERSE POLARITY SMA MALE TO BNC MALE



Cable Model No.

Standard Flexible Cable Assemblies

See website for the following cable(s)	
50 Ohm, RG58C/U Coax	PE35207
50 Ohm, RG142B/U Coax	PE35209
50 Ohm, RG174A/U Coax	PE35211

16

17

18

\*Coax Performance at 1 GHz  
Notes: Cable assembly max frequency may be lower than connector or coax max frequency

### REVERSE POLARITY SMA FEMALE BULKHEAD TO UMCX PLUG RIGHT ANGLE

SEE MOUNTING HOLE SECTION ON PAGE 246



Cable	Model No.
Standard Flexible Cable Assemblies	
<b>See website for the following cable(s)</b>	
50 Ohm, RG178B/U Coax	PE38300

**1**

### REVERSE THREAD SMA FEMALE BULKHEAD TO UMCX PLUG RIGHT ANGLE

SEE MOUNTING HOLE SECTION ON PAGE 246



Cable	Model No.
Standard Flexible Cable Assemblies	
<b>See website for the following cable(s)</b>	
50 Ohm, RG178B/U Coax	PE38301

**2**

### 3.5MM MALE TO 3.5MM MALE



Cable	Model No.
Precision Flexible Cable Assemblies	
<b>Please see precision section, page 6-29</b>	
50 Ohm, VNA CABLE Coax	PE315
Standard Semirigid Cable Assemblies	
<b>See website for the following cable(s)</b>	
50 Ohm, PE-SR402AL Coax	PE34572

**3**

### 3.5MM MALE TO 3.5MM FEMALE



Cable	Model No.
Precision Flexible Cable Assemblies	
<b>Please see precision section, page 6-29</b>	
50 Ohm, VNA CABLE Coax	PE317

**5**

### 2.92MM MALE TO 2.92MM MALE



Cable	Model No.
Precision Flexible Cable Assemblies	
<b>Please see precision section, page 6-29</b>	
50 Ohm, VNA CABLE Coax	PE319
50 Ohm, 095 Series Coax	PE35591
Standard Formable Cable Assemblies	
<b>See website for the following cable(s)</b>	
50 Ohm, PE-SR402FL Coax	PE34733
50 Ohm, PE-SR405FL Coax	PE34737
Standard Semirigid Cable Assemblies	
<b>See website for the following cable(s)</b>	
50 Ohm, RG405/U Coax	PE34735

**6**  
**7**  
**8**  
**9**  
**10**

### 2.92MM MALE TO 2.92MM FEMALE



Cable	Model No.
Precision Flexible Cable Assemblies	
<b>Please see precision section, page 6-29</b>	
50 Ohm, VNA CABLE Coax	PE321

**11**

### 2.92MM MALE TO 2.92MM FEMALE BULKHEAD

SEE MOUNTING HOLE SECTION ON PAGE 246



Cable	Model No.
Standard Formable Cable Assemblies	
<b>See website for the following cable(s)</b>	
50 Ohm, PE-SR402FL Coax	PE34745
50 Ohm, PE-SR405FL Coax	PE34749
Standard Semirigid Cable Assemblies	
<b>See website for the following cable(s)</b>	
50 Ohm, PE-SR402AL Coax	PE34743
50 Ohm, RG402/U Coax	PE34741
50 Ohm, RG405/U Coax	PE34747

**12**  
**13**  
**14**  
**15**  
**16**

### 2.92MM MALE TO 2.4MM MALE



Cable	Model No.
Precision Flexible Cable Assemblies	
<b>Please see precision section, page 6-29</b>	
50 Ohm, 095 Series Coax	PE35606
Standard Formable Cable Assemblies	
<b>See website for the following cable(s)</b>	
50 Ohm, PE-SR405FL Coax	PE35664
Standard Semirigid Cable Assemblies	
<b>See website for the following cable(s)</b>	
50 Ohm, RG405/U Coax	PE35660

**17**  
**18**  
**19**

### 2.92MM MALE TO 1.85MM MALE



Cable	Model No.
Precision Flexible Cable Assemblies	
<b>Please see precision section, page 6-29</b>	
50 Ohm, 095 Series Coax	PE36674

**20**

### 2.4MM MALE TO 2.4MM MALE



Cable	Model No.
Precision Flexible Cable Assemblies	
<b>Please see precision section, page 6-29</b>	
50 Ohm, 095 Series Coax	PE35611
Standard Formable Cable Assemblies	
<b>See website for the following cable(s)</b>	
50 Ohm, PE-SR405FL Coax	PE35652

**21**  
**22**

Continued on Next Page

Continued from Previous Page

### 2.4MM MALE TO 2.4MM MALE



Cable Model No.

Standard Semirigid Cable Assemblies

**See website for the following cable(s)**

50 Ohm, RG405/U Coax	PE35639	1
----------------------	---------	---

### 2.4MM MALE TO 2.4MM FEMALE



Cable Model No.

Standard Formable Cable Assemblies

**See website for the following cable(s)**

50 Ohm, PE-SR405FL Coax	PE35658	2
-------------------------	---------	---

Standard Semirigid Cable Assemblies

**See website for the following cable(s)**

50 Ohm, RG405/U Coax	PE35654	3
----------------------	---------	---

### 2.4MM MALE TO 1.85MM MALE



Cable Model No.

Precision Flexible Cable Assemblies

**See website for the following cable(s)**

50 Ohm, 095 Series Coax	PE36676	4
-------------------------	---------	---

### 1.85MM MALE TO 1.85MM MALE



Cable Dia. Model No.

Precision Flexible Cable Assemblies

**See website for the following cable(s)**

50 Ohm, 095 Series Coax	PE36678	5
-------------------------	---------	---

Standard Formable Cable Assemblies

**See website for the following cable(s)**

50 Ohm, PE-SR047FL Coax	PE36521	6
-------------------------	---------	---

Standard Semirigid Cable Assemblies

**See website for the following cable(s)**

50 Ohm, PE-047SR Coax	PE36519	7
-----------------------	---------	---

### SSMA MALE TO SSMA MALE



Cable Model No.

Standard Flexible Cable Assemblies

**See website for the following cable(s)**

50 Ohm, RG174A/U Coax	PE3673	8
50 Ohm, RG178B/U Coax	PE33762	9
50 Ohm, RG316/U Coax	PE33071	10

There are currently more than 2,500 satellites orbiting Earth.

### N MALE TO N MALE



Cable Dia. Atten. \* Max Power \* Length Model No. 1-24 25-49 50-99

Precision Flexible Cable Assemblies

**Please see precision section, page 6-29**

50 Ohm, 150 Series Coax	PE33232	11
50 Ohm, 165 Non-Magnetic Series Coax	PE35028	12
50 Ohm, 300 Series Coax	PE302	13

Precision Formable Cable Assemblies

**Please see precision section, page 6-29**

50 Ohm, PE-SR402FL Coax	PE39451	14
50 Ohm, PE-SR402FLJ Jacketed Coax	PE39465	15
50 Ohm, PE-SR405FL Coax	PE39443	16
50 Ohm, PE-SR405FLJ Jacketed Coax	PE39457	17

Standard Flexible Cable Assemblies

**52 Ohm, RG8A/U Coax**

0.405" dia.	9 dB / 100 ft.	190 W	12"	PE3570-12	\$45.60	\$42.41	\$39.22
			24"	PE3570-24	\$47.80	\$44.45	\$41.11
			36"	PE3570-36	\$49.95	\$46.45	\$42.96
			48"	PE3570-48	\$52.15	\$48.50	\$44.85
			60"	PE3570-60	\$54.30	\$50.50	\$46.70
			Any	PE3570-XX	See Website for Pricing		

**See website for the following cable(s)**

53.5 Ohm, RG55B/U Coax	PE3499	19
------------------------	--------	----

**50 Ohm, RG58C/U Coax**

0.195" dia.	20 dB / 100 ft.	44 W	12"	PE3441-12	\$35.05	\$32.60	\$30.14
			24"	PE3441-24	\$35.50	\$33.02	\$30.53
			36"	PE3441-36	\$36.35	\$33.81	\$31.26
			48"	PE3441-48	\$36.85	\$34.27	\$31.69
			60"	PE3441-60	\$37.55	\$34.92	\$32.29
			Any	PE3441-XX	See Website for Pricing		

**See website for the following cable(s)**

50 Ohm, RG141A/U Coax	PE36589	21
-----------------------	---------	----

**50 Ohm, RG142B/U Coax**

0.195" dia.	13 dB / 100 ft.	650 W	12"	PE3455-12	\$36.90	\$34.32	\$31.73
			24"	PE3455-24	\$41.00	\$38.13	\$35.26
			36"	PE3455-36	\$45.15	\$41.99	\$38.83
			48"	PE3455-48	\$49.30	\$45.85	\$42.40
			60"	PE3455-60	\$53.45	\$49.71	\$45.97
			Any	PE3455-XX	See Website for Pricing		

**See website for the following cable(s)**

50 Ohm, RG174A/U Coax	PE36273	23
-----------------------	---------	----

50 Ohm, RG178B/U Coax	PE33527	24
-----------------------	---------	----

50 Ohm, RG188A/U Coax	PE33525	25
-----------------------	---------	----

**50 Ohm, RG213/U Coax**

0.405" dia.	9 dB / 100 ft.	190 W	12"	PE3496-12	\$44.70	\$41.57	\$38.44
			24"	PE3496-24	\$45.95	\$42.73	\$39.52
			36"	PE3496-36	\$47.15	\$43.85	\$40.55
			48"	PE3496-48	\$48.40	\$45.01	\$41.62
			60"	PE3496-60	\$49.65	\$46.17	\$42.70
			Any	PE3496-XX	See Website for Pricing		

**50 Ohm, RG214/U Coax**

0.425" dia.	9 dB / 100 ft.	190 W	12"	PE3062-12	\$48.75	\$45.34	\$41.93
			24"	PE3062-24	\$54.50	\$50.69	\$46.87
			36"	PE3062-36	\$60.25	\$56.03	\$51.82
			48"	PE3062-48	\$66.00	\$61.38	\$56.76
			60"	PE3062-60	\$71.75	\$66.73	\$61.71
			Any	PE3062-XX	See Website for Pricing		

**See website for the following cable(s)**

50 Ohm, RG217/U Coax	PE3997	28
----------------------	--------	----

50 Ohm, RG218/U Coax	PE33236	29
----------------------	---------	----

Cable Assemblies

\*Coax Performance at 1 GHz  
Notes: Cable assembly max frequency may be lower than connector or coax max frequency

Continued on Next Page

Continued from Previous Page

N MALE TO N MALE							
							
Cable Dia.	Atten.*	Max Power*	Length	Model No.	1-24	25-49	50-99
<b>50 Ohm, RG223/U Coax</b>							
0.216" dia.	16.5 dB / 100 ft.	53 W	12"	PE3447-12	\$34.95	\$32.50	\$30.06
			24"	PE3447-24	\$37.15	\$34.55	\$31.95
			36"	PE3447-36	\$39.35	\$36.60	\$33.84
			48"	PE3447-48	\$41.60	\$38.69	\$35.78
			60"	PE3447-60	\$43.80	\$40.73	\$37.67
			Any	PE3447-XX	See Website for Pricing		
<b>See website for the following cable(s)</b>							
50 Ohm, RG225/U Coax				PE33269			
<b>50 Ohm, RG316/U Coax</b>							
0.102" dia.	30 dB / 100 ft.	160 W	12"	PE3487-12	\$41.15	\$38.27	\$35.39
			24"	PE3487-24	\$43.55	\$40.50	\$37.45
			36"	PE3487-36	\$45.95	\$42.73	\$39.52
			48"	PE3487-48	\$48.35	\$44.97	\$41.58
			60"	PE3487-60	\$50.70	\$47.15	\$43.60
			Any	PE3487-XX	See Website for Pricing		
<b>See website for the following cable(s)</b>							
50 Ohm, RG316-DS Coax				PE33288			
<b>50 Ohm, RG393/U Coax</b>							
0.390" dia.	7.5 dB / 100 ft.	1700 W	12"	PE3607-12	\$55.05	\$51.20	\$47.34
			24"	PE3607-24	\$67.05	\$62.36	\$57.66
			36"	PE3607-36	\$79.05	\$73.52	\$67.98
			48"	PE3607-48	\$91.10	\$84.72	\$78.35
			60"	PE3607-60	\$103.10	\$95.88	\$88.67
			Any	PE3607-XX	See Website for Pricing		
<b>50 Ohm, RG400/U Coax</b>							
0.195" dia.	13 dB / 100 ft.	650 W	12"	PE3653-12	\$42.60	\$39.62	\$36.64
			24"	PE3653-24	\$48.00	\$44.64	\$41.28
			36"	PE3653-36	\$52.55	\$48.87	\$45.19
			48"	PE3653-48	\$56.30	\$52.36	\$48.42
			60"	PE3653-60	\$60.25	\$56.03	\$51.82
			Any	PE3653-XX	See Website for Pricing		
<b>See website for the following cable(s)</b>							
50 Ohm, PE-B400 Coax				PE3629			
<b>50 Ohm, PE-B405 Coax</b>							
0.405" dia.	4.5 dB / 100 ft.	344 W	12"	PE3279-12	\$46.45	\$43.20	\$39.95
			24"	PE3279-24	\$47.40	\$44.08	\$40.76
			36"	PE3279-36	\$48.40	\$45.01	\$41.62
			48"	PE3279-48	\$49.45	\$45.99	\$42.53
			60"	PE3279-60	\$50.85	\$47.29	\$43.73
			Any	PE3279-XX	See Website for Pricing		
<b>50 Ohm, PE-C195 Coax</b>							
0.195" dia.	11.5 dB / 100 ft.	150 W	36"	PE37940-36	\$34.35	\$31.95	\$29.54
			48"	PE37940-48	\$35.45	\$32.97	\$30.49
			60"	PE37940-60	\$36.60	\$34.04	\$31.48
			72"	PE37940-72	\$37.70	\$35.06	\$32.42
			120"	PE37940-120	\$42.15	\$39.20	\$36.25
			Any	PE37940-XX	See Website for Pricing		
<b>50 Ohm, PE-C240 Coax</b>							
0.240" dia.	8 dB / 100 ft.	250 W	36"	PE37941-36	\$38.15	\$35.48	\$32.81
			48"	PE37941-48	\$40.35	\$37.53	\$34.70
			60"	PE37941-60	\$42.70	\$39.71	\$36.72
			72"	PE37941-72	\$45.05	\$41.90	\$38.74
			120"	PE37941-120	\$54.40	\$50.59	\$46.78
			Any	PE37941-XX	See Website for Pricing		
<b>50 Ohm, PE-C300 Coax</b>							
0.300" dia.	6.5 dB / 100 ft.	350 W	12"	PE36634-12	\$48.35	\$44.97	\$41.58
			24"	PE36634-24	\$50.50	\$46.97	\$43.43
			36"	PE36634-36	\$52.70	\$49.01	\$45.32
			48"	PE36634-48	\$54.85	\$51.01	\$47.17
			60"	PE36634-60	\$57.05	\$53.06	\$49.06
			Any	PE36634-XX	See Website for Pricing		

N MALE TO N MALE									
									
Cable Dia.	Atten.*	Max Power*	Length	Model No.	1-24	25-49	50-99		
<b>50 Ohm, PE-C400 Coax</b>									
0.405" dia.	4.5 dB / 100 ft.	550 W	36"	PE37942-36	\$53.65	\$49.89	\$46.14		
			48"	PE37942-48	\$57.65	\$53.61	\$49.58		
			60"	PE37942-60	\$61.65	\$57.33	\$53.02		
			72"	PE37942-72	\$65.65	\$61.05	\$56.46		
			Any	PE37942-XX	See Website for Pricing				
			<b>See website for the following cable(s)</b>						
50 Ohm, PE-C500 Coax				PE35522					
<b>50 Ohm, PE-C600 Coax</b>									
0.590" dia.	3 dB / 100 ft.	900 W	36"	PE37943-36	\$76.70	\$71.33	\$65.96		
			48"	PE37943-48	\$81.60	\$75.89	\$70.18		
			60"	PE37943-60	\$86.50	\$80.45	\$74.39		
			72"	PE37943-72	\$91.40	\$85.00	\$78.60		
			120"	PE37943-120	\$111.00	\$103.23	\$95.46		
			Any	PE37943-XX	See Website for Pricing				
<b>See website for the following cable(s)</b>									
50 Ohm, PE-P195 Coax				PE33377					
Standard Formable Cable Assemblies									
<b>See website for the following cable(s)</b>									
50 Ohm, PE-SR401FL Coax				PE34149					
50 Ohm, PE-SR402FL Coax				PE3472					
50 Ohm, PE-SR405FL Coax				PE3963					
50 Ohm, 1/2" Helical Coax				PE37968					
Standard Semirigid Cable Assemblies									
<b>See website for the following cable(s)</b>									
50 Ohm, PE-047SR Coax				PE34142					
50 Ohm, PE-SR402AL Coax				PE34138					
50 Ohm, RG401/U Coax				PE3782					
<b>50 Ohm, RG402/U Coax</b>									
50 Ohm, RG402/U Coax				PE3827					
<b>See website for the following cable(s)</b>									
50 Ohm, RG405/U Coax				PE3920					

N MALE TO N MALE RIGHT ANGLE							
							
Cable Dia.	Atten.*	Max Power*	Length	Model No.	1-24	25-49	50-99
Precision Flexible Cable Assemblies							
<b>Please see precision section, page 6-29</b>							
50 Ohm, 300 Series Coax				PE303			
Precision Formable Cable Assemblies							
<b>Please see precision section, page 6-29</b>							
50 Ohm, PE-SR402FL Coax				PE39453			
50 Ohm, PE-SR402FLJ Jacketed Coax				PE39467			
50 Ohm, PE-SR405FL Coax				PE39445			
50 Ohm, PE-SR405FLJ Jacketed Coax				PE39459			
Standard Flexible Cable Assemblies							
<b>52 Ohm, RG8A/U Coax</b>							
0.405" dia.	9 dB / 100 ft.	190 W	12"	PE3699-12	\$61.25	\$56.96	\$52.68
			24"	PE3699-24	\$63.45	\$59.01	\$54.57
			36"	PE3699-36	\$65.60	\$61.01	\$56.42
			48"	PE3699-48	\$67.80	\$63.05	\$58.31
			60"	PE3699-60	\$69.95	\$65.05	\$60.16
			Any	PE3699-XX	See Website for Pricing		

**The N connector was one of the first connectors capable of carrying microwave-frequency signals.**

Cable Assemblies

\*Coax Performance at 1 GHz  
Notes: Cable assembly max frequency may be lower than connector or coax max frequency

Continued on Next Page



Continued from Previous Page

### N MALE TO N MALE RIGHT ANGLE



Cable Dia.	Atten.*	Max Power*	Length	Model No.	1-24	25-49	50-99
<b>50 Ohm, RG58C/U Coax</b>							
0.195" dia.	20 dB / 100 ft.	44 W	12"	PE3143-12	\$47.75	\$44.41	\$41.07
			24"	PE3143-24	\$48.25	\$44.87	\$41.50
			36"	PE3143-36	\$48.65	\$45.24	\$41.84
			48"	PE3143-48	\$49.10	\$45.66	\$42.23
			60"	PE3143-60	\$49.50	\$46.04	\$42.57
Any	PE3143-XX	See Website for Pricing					
<b>50 Ohm, RG142B/U Coax</b>							
0.195" dia.	13 dB / 100 ft.	650 W	12"	PE3726-12	\$47.75	\$44.41	\$41.07
			24"	PE3726-24	\$51.65	\$48.03	\$44.42
			36"	PE3726-36	\$55.80	\$51.89	\$47.99
			48"	PE3726-48	\$59.95	\$55.75	\$51.56
			60"	PE3726-60	\$64.10	\$59.61	\$55.13
Any	PE3726-XX	See Website for Pricing					
<b>50 Ohm, RG213/U Coax</b>							
0.405" dia.	9 dB / 100 ft.	190 W	12"	PE3797-12	\$60.35	\$56.13	\$51.90
			24"	PE3797-24	\$61.60	\$57.29	\$52.98
			36"	PE3797-36	\$62.80	\$58.40	\$54.01
			48"	PE3797-48	\$64.05	\$59.57	\$55.08
			60"	PE3797-60	\$65.30	\$60.73	\$56.16
Any	PE3797-XX	See Website for Pricing					
<b>50 Ohm, RG214/U Coax</b>							
0.425" dia.	9 dB / 100 ft.	190 W	12"	PE3071-12	\$67.50	\$62.78	\$58.05
			24"	PE3071-24	\$73.25	\$68.12	\$63.00
			36"	PE3071-36	\$79.00	\$73.47	\$67.94
			48"	PE3071-48	\$84.75	\$78.82	\$72.89
			60"	PE3071-60	\$90.50	\$84.17	\$77.83
Any	PE3071-XX	See Website for Pricing					
<b>50 Ohm, RG223/U Coax</b>							
0.216" dia.	16.5 dB / 100 ft.	53 W	12"	PE3168-12	\$47.75	\$44.41	\$41.07
			24"	PE3168-24	\$49.15	\$45.71	\$42.27
			36"	PE3168-36	\$50.50	\$46.97	\$43.43
			48"	PE3168-48	\$52.25	\$48.59	\$44.94
			60"	PE3168-60	\$54.45	\$50.64	\$46.83
Any	PE3168-XX	See Website for Pricing					
<b>See website for the following cable(s)</b>							
50 Ohm, RG225/U Coax				PE34203			
50 Ohm, RG316-DS Coax				PE34207			
50 Ohm, RG393/U Coax				PE3255			
<b>50 Ohm, RG400/U Coax</b>							
0.195" dia.	13 dB / 100 ft.	650 W	12"	PE33321-12	\$53.25	\$49.52	\$45.80
			24"	PE33321-24	\$58.65	\$54.54	\$50.44
			36"	PE33321-36	\$64.10	\$59.61	\$55.13
			48"	PE33321-48	\$69.50	\$64.64	\$59.77
			60"	PE33321-60	\$74.95	\$69.70	\$64.46
Any	PE33321-XX	See Website for Pricing					
<b>See website for the following cable(s)</b>							
50 Ohm, PE-B405 Coax				PE3962			
50 Ohm, PE-C195 Coax				PE37944			
50 Ohm, PE-C240 Coax				PE37945			
<b>50 Ohm, PE-C400 Coax</b>							
0.405" dia.	4.5 dB / 100 ft.	550 W	36"	PE37946-36	\$69.40	\$64.54	\$59.68
			48"	PE37946-48	\$73.40	\$68.26	\$63.12
			60"	PE37946-60	\$77.40	\$71.98	\$66.56
			72"	PE37946-72	\$81.40	\$75.70	\$70.00
			120"	PE37946-120	\$93.80	\$87.23	\$80.67
Any	PE37946-XX	See Website for Pricing					

### N MALE TO N MALE RIGHT ANGLE



Cable Dia.	Atten.*	Max Power*	Length	Model No.	1-24	25-49	50-99
<b>50 Ohm, PE-C600 Coax</b>							
0.590" dia.	3 dB / 100 ft.	900 W	36"	PE37947-36	\$84.80	\$78.86	\$72.93
			48"	PE37947-48	\$88.00	\$81.84	\$75.68
			60"	PE37947-60	\$91.20	\$84.82	\$78.43
			72"	PE37947-72	\$94.35	\$87.75	\$81.14
			120"	PE37947-120	\$107.10	\$99.60	\$92.11
Any	PE37947-XX	See Website for Pricing					
<b>Standard Formable Cable Assemblies</b>							
<b>See website for the following cable(s)</b>							
50 Ohm, 1/2" Helical Coax				PE37970			

### N MALE TO N FEMALE



Cable	Model No.
<b>Precision Formable Cable Assemblies</b>	
<b>Please see precision section, page 6-29</b>	
50 Ohm, PE-SR402FL Coax	PE39454
50 Ohm, PE-SR402FLJ Jacketed Coax	PE39468
50 Ohm, PE-SR405FL Coax	PE39446
50 Ohm, PE-SR405FLJ Jacketed Coax	PE39460
<b>Standard Flexible Cable Assemblies</b>	
<b>See website for the following cable(s)</b>	
50 Ohm, RG58C/U Coax	PE3714
50 Ohm, RG142B/U Coax	PE3996
50 Ohm, RG213/U Coax	PE3232
50 Ohm, RG214/U Coax	PE3650
50 Ohm, RG223/U Coax	PE3667
50 Ohm, RG316-DS Coax	PE34281
50 Ohm, RG393/U Coax	PE3977
50 Ohm, RG400/U Coax	PE3617
50 Ohm, PE-C195 Coax	PE37948
50 Ohm, PE-C240 Coax	PE37949
50 Ohm, PE-C400 Coax	PE37950
50 Ohm, PE-C600 Coax	PE37951
<b>Standard Formable Cable Assemblies</b>	
<b>See website for the following cable(s)</b>	
50 Ohm, PE-SR402FL Coax	PE3485
50 Ohm, 1/2" Helical Coax	PE37969
<b>Standard Semirigid Cable Assemblies</b>	
<b>See website for the following cable(s)</b>	
50 Ohm, PE-047SR Coax	PE34287
50 Ohm, PE-SR402AL Coax	PE34289
50 Ohm, RG401/U Coax	PE37979

### N MALE TO N FEMALE BULKHEAD

SEE MOUNTING HOLE SECTION ON PAGE 246



Cable Dia.	Atten.*	Max Power*	Length	Model No.	1-24	25-49	50-99
<b>Precision Flexible Cable Assemblies</b>							
<b>Please see precision section, page 6-29</b>							
50 Ohm, 150 Series Coax				PE35952			
50 Ohm, 165 Non-Magnetic Series Coax				PE35956			
<b>Standard Flexible Cable Assemblies</b>							
<b>See website for the following cable(s)</b>							
52 Ohm, RG8AU Coax				PE3966			

Cable Assemblies

\*Coax Performance at 1 GHz  
Notes: Cable assembly max frequency may be lower than connector or coax max frequency

Continued on Next Page

Continued from Previous Page

### N MALE TO N FEMALE BULKHEAD

SEE MOUNTING HOLE SECTION ON PAGE 246



Cable Dia.	Atten.*	Max Power*	Length	Model No.	1-24	25-49	50-99
<b>50 Ohm, RG58C/U Coax</b>							
0.195" dia.	20 dB / 100 ft.	44 W	12"	PE3320-12	\$46.45	\$43.20	\$39.95
			24"	PE3320-24	\$46.80	\$43.52	\$40.25
			36"	PE3320-36	\$47.25	\$43.94	\$40.64
			48"	PE3320-48	\$47.65	\$44.31	\$40.98
			60"	PE3320-60	\$48.15	\$44.78	\$41.41
			Any	PE3320-XX	See Website for Pricing		
<b>50 Ohm, RG142B/U Coax</b>							
0.195" dia.	13 dB / 100 ft.	650 W	12"	PE3034-12	\$46.45	\$43.20	\$39.95
			24"	PE3034-24	\$49.15	\$45.71	\$42.27
			36"	PE3034-36	\$51.90	\$48.27	\$44.63
			48"	PE3034-48	\$54.60	\$50.78	\$46.96
			60"	PE3034-60	\$57.35	\$53.34	\$49.32
			Any	PE3034-XX	See Website for Pricing		
<b>See website for the following cable(s)</b>							
50 Ohm, RG178B/U Coax				PE34201			
50 Ohm, RG213/U Coax				PE33543			
<b>50 Ohm, RG214/U Coax</b>							
0.425" dia.	9 dB / 100 ft.	190 W	12"	PE3217-12	\$59.00	\$54.87	\$50.74
			24"	PE3217-24	\$64.75	\$60.22	\$55.69
			36"	PE3217-36	\$70.50	\$65.57	\$60.63
			48"	PE3217-48	\$76.25	\$70.91	\$65.58
			60"	PE3217-60	\$82.00	\$76.26	\$70.52
			Any	PE3217-XX	See Website for Pricing		
<b>See website for the following cable(s)</b>							
50 Ohm, RG223/U Coax				PE3686			
50 Ohm, RG316/U Coax				PE33534			
50 Ohm, RG316-DS Coax				PE34198			
<b>50 Ohm, RG400/U Coax</b>							
0.195" dia.	13 dB / 100 ft.	650 W	12"	PE3227-12	\$46.45	\$43.20	\$39.95
			24"	PE3227-24	\$50.95	\$47.38	\$43.82
			36"	PE3227-36	\$56.40	\$52.45	\$48.50
			48"	PE3227-48	\$61.80	\$57.47	\$53.15
			60"	PE3227-60	\$67.25	\$62.54	\$57.84
			Any	PE3227-XX	See Website for Pricing		
<b>See website for the following cable(s)</b>							
50 Ohm, PE-B405 Coax				PE34196			
50 Ohm, PE-C240 Coax				PE38672			
<b>Standard Formable Cable Assemblies</b>							
<b>See website for the following cable(s)</b>							
50 Ohm, PE-SR401FL Coax				PE34150			
<b>50 Ohm, PE-SR402FL Coax</b>							
0.141" dia.	12 dB / 100 ft.	450 W	12"	PE3488-12	\$87.90	\$81.75	\$75.59
			24"	PE3488-24	\$91.60	\$85.19	\$78.78
			36"	PE3488-36	\$95.35	\$88.68	\$82.00
			48"	PE3488-48	\$99.10	\$92.16	\$85.23
			60"	PE3488-60	\$102.75	\$95.56	\$88.37
			Any	PE3488-XX	See Website for Pricing		
<b>Standard Semirigid Cable Assemblies</b>							
<b>See website for the following cable(s)</b>							
50 Ohm, RG402/U Coax				PE3830			
<b>N MALE RIGHT ANGLE TO N MALE RIGHT ANGLE</b>							
Cable Dia.	Atten.*	Max Power*	Length	Model No.	1-24	25-49	50-99
<b>Precision Formable Cable Assemblies</b>							
50 Ohm, PE-SR402FL Coax				PE39452			

### N MALE RIGHT ANGLE TO N MALE RIGHT ANGLE



Cable Dia.	Atten.*	Max Power*	Length	Model No.	1-24	25-49	50-99
<b>Standard Flexible Cable Assemblies</b>							
<b>52 Ohm, RG8A/U Coax</b>							
0.405" dia.	9 dB / 100 ft.	190 W	12"	PE33974-12	\$76.90	\$71.52	\$66.13
			24"	PE33974-24	\$79.10	\$73.56	\$68.03
			36"	PE33974-36	\$81.25	\$75.56	\$69.88
			48"	PE33974-48	\$83.45	\$77.61	\$71.77
			60"	PE33974-60	\$85.60	\$79.61	\$73.62
Any	PE33974-XX	See Website for Pricing					
<b>See website for the following cable(s)</b>							
50 Ohm, RG58C/U Coax				PE3698			
50 Ohm, RG142B/U Coax				PE3693			
50 Ohm, RG174A/U Coax				PE34231			
50 Ohm, RG213/U Coax				PE3272			
<b>50 Ohm, RG214/U Coax</b>							
0.425" dia.	9 dB / 100 ft.	190 W	12"	PE3781-12	\$86.20	\$80.17	\$74.13
			24"	PE3781-24	\$91.95	\$85.51	\$79.08
			36"	PE3781-36	\$97.70	\$90.86	\$84.02
			48"	PE3781-48	\$103.45	\$96.21	\$88.97
			60"	PE3781-60	\$109.20	\$101.56	\$93.91
			Any	PE3781-XX	See Website for Pricing		
<b>See website for the following cable(s)</b>							
50 Ohm, RG223/U Coax				PE3882			
50 Ohm, RG316/U Coax				PE34236			
50 Ohm, RG393/U Coax				PE3268			
50 Ohm, RG400/U Coax				PE3412			
50 Ohm, PE-B405 Coax				PE33168			
50 Ohm, PE-C195 Coax				PE36910			
50 Ohm, PE-C240 Coax				PE38699			
<b>Standard Formable Cable Assemblies</b>							
<b>See website for the following cable(s)</b>							
50 Ohm, PE-SR401FL Coax				PE34680			
50 Ohm, PE-SR402FL Coax				PE33977			
<b>N MALE RIGHT ANGLE TO N FEMALE BULKHEAD</b>							
SEE MOUNTING HOLE SECTION ON PAGE 246							
Cable Dia.	Atten.*	Max Power*	Length	Model No.	1-24	25-49	50-99
<b>Standard Flexible Cable Assemblies</b>							
50 Ohm, RG58C/U Coax				PE3407			
<b>50 Ohm, RG142B/U Coax</b>							
0.195" dia.	13 dB / 100 ft.	650 W	12"	PE33021-12	\$54.60	\$50.78	\$46.96
			24"	PE33021-24	\$57.35	\$53.34	\$49.32
			36"	PE33021-36	\$60.10	\$55.89	\$51.69
			48"	PE33021-48	\$62.90	\$58.50	\$54.09
			60"	PE33021-60	\$67.05	\$62.36	\$57.66
			Any	PE33021-XX	See Website for Pricing		
<b>See website for the following cable(s)</b>							
50 Ohm, RG188A/U Coax				PE34218			
50 Ohm, RG213/U Coax				PE33545			
50 Ohm, RG214/U Coax				PE33178			
50 Ohm, RG316-DS Coax				PE34227			
50 Ohm, RG393/U Coax				PE33532			
50 Ohm, RG400/U Coax				PE33528			

Cable Assemblies

\*Coax Performance at 1 GHz  
Notes: Cable assembly max frequency may be lower than connector or coax max frequency

Continued on Next Page

Continued from Previous Page

### N MALE RIGHT ANGLE TO N FEMALE BULKHEAD

SEE MOUNTING HOLE SECTION ON PAGE 246



Cable Dia.	Atten.*	Max Power*	Length	Model No.	1-24	25-49	50-99
<b>Standard Formable Cable Assemblies</b>							
<b>See website for the following cable(s)</b>							
50 Ohm, PE-SR401FL Coax				PE39082			1

### N MALE TO TNC MALE



Cable Dia.	Atten.*	Max Power*	Length	Model No.	1-24	25-49	50-99
<b>Standard Flexible Cable Assemblies</b>							
<b>See website for the following cable(s)</b>							
52 Ohm, RG8A/U Coax				PE33615			2

50 Ohm, RG58C/U Coax							
Cable Dia.	Atten.*	Max Power*	Length	Model No.	1-24	25-49	50-99
0.195" dia.	20 dB / 100 ft.	44 W	12"	PE3661-12	\$33.55	\$31.20	\$28.85
			24"	PE3661-24	\$34.10	\$31.71	\$29.33
			36"	PE3661-36	\$34.65	\$32.22	\$29.80
			48"	PE3661-48	\$35.15	\$32.69	\$30.23
			60"	PE3661-60	\$35.70	\$33.20	\$30.70
			Any	PE3661-XX	See Website for Pricing		

50 Ohm, RG142B/U Coax							
Cable Dia.	Atten.*	Max Power*	Length	Model No.	1-24	25-49	50-99
0.195" dia.	13 dB / 100 ft.	650 W	12"	PE3652-12	\$35.10	\$32.64	\$30.19
			24"	PE3652-24	\$39.25	\$36.50	\$33.76
			36"	PE3652-36	\$43.40	\$40.36	\$37.32
			48"	PE3652-48	\$47.50	\$44.18	\$40.85
			60"	PE3652-60	\$51.65	\$48.03	\$44.42
Any	PE3652-XX	See Website for Pricing				4	

**See website for the following cable(s)**

50 Ohm, RG174A/U Coax	PE34272						5
-----------------------	---------	--	--	--	--	--	---

50 Ohm, RG213/U Coax							
Cable Dia.	Atten.*	Max Power*	Length	Model No.	1-24	25-49	50-99
0.405" dia.	9 dB / 100 ft.	190 W	12"	PE3644-12	\$46.60	\$43.34	\$40.08
			24"	PE3644-24	\$47.85	\$44.50	\$41.15
			36"	PE3644-36	\$49.10	\$45.66	\$42.23
			48"	PE3644-48	\$50.30	\$46.78	\$43.26
			60"	PE3644-60	\$51.55	\$47.94	\$44.33
Any	PE3644-XX	See Website for Pricing				6	

**See website for the following cable(s)**

50 Ohm, RG214/U Coax	PE3991						7
----------------------	--------	--	--	--	--	--	---

50 Ohm, RG223/U Coax							
Cable Dia.	Atten.*	Max Power*	Length	Model No.	1-24	25-49	50-99
0.216" dia.	16.5 dB / 100 ft.	53 W	12"	PE3665-12	\$33.15	\$30.83	\$28.51
			24"	PE3665-24	\$35.40	\$32.92	\$30.44
			36"	PE3665-36	\$37.60	\$34.97	\$32.34
			48"	PE3665-48	\$39.80	\$37.01	\$34.23
			60"	PE3665-60	\$42.00	\$39.06	\$36.12
Any	PE3665-XX	See Website for Pricing				8	

**See website for the following cable(s)**

50 Ohm, RG316/U Coax	PE3989						9
----------------------	--------	--	--	--	--	--	---

50 Ohm, RG393/U Coax							
Cable Dia.	Atten.*	Max Power*	Length	Model No.	1-24	25-49	50-99
0.390" dia.	7.5 dB / 100 ft.	1700 W	12"	PE3982-12	\$62.95	\$58.54	\$54.14
			24"	PE3982-24	\$74.95	\$69.70	\$64.46
			36"	PE3982-36	\$87.00	\$80.91	\$74.82
			48"	PE3982-48	\$99.00	\$92.07	\$85.14
			60"	PE3982-60	\$111.05	\$103.28	\$95.50
Any	PE3982-XX	See Website for Pricing				10	

50 Ohm, RG400/U Coax							
Cable Dia.	Atten.*	Max Power*	Length	Model No.	1-24	25-49	50-99
0.195" dia.	13 dB / 100 ft.	650 W	12"	PE3666-12	\$40.80	\$37.94	\$35.09
			24"	PE3666-24	\$46.25	\$43.01	\$39.78
			36"	PE3666-36	\$50.60	\$47.06	\$43.52
			48"	PE3666-48	\$54.50	\$50.69	\$46.87
			60"	PE3666-60	\$58.35	\$54.27	\$50.18
Any	PE3666-XX	See Website for Pricing				11	

### N MALE TO TNC MALE



Cable Dia.	Atten.*	Max Power*	Length	Model No.	1-24	25-49	50-99
<b>See website for the following cable(s)</b>							
50 Ohm, PE-C195 Coax				PE35785			12
50 Ohm, PE-C240 Coax				PE36958			13
50 Ohm, PE-C300 Coax				PE37980			14
50 Ohm, PE-C400 Coax				PE34801			15

### N MALE TO REVERSE POLARITY TNC MALE



Cable Dia.	Atten.*	Max Power*	Length	Model No.	1-24	25-49	50-99
<b>Standard Flexible Cable Assemblies</b>							
<b>50 Ohm, RG58C/U Coax</b>							
0.195" dia.	20 dB / 100 ft.	44 W	12"	PE34554-12	\$34.85	\$32.41	\$29.97
			24"	PE34554-24	\$35.40	\$32.92	\$30.44
			36"	PE34554-36	\$35.90	\$33.39	\$30.87
			48"	PE34554-48	\$36.45	\$33.90	\$31.35
			60"	PE34554-60	\$37.00	\$34.41	\$31.82
			Any	PE34554-XX	See Website for Pricing		

**See website for the following cable(s)**

50 Ohm, RG142B/U Coax	PE34573						17
-----------------------	---------	--	--	--	--	--	----

50 Ohm, RG223/U Coax							
Cable Dia.	Atten.*	Max Power*	Length	Model No.	1-24	25-49	50-99
0.216" dia.	16.5 dB / 100 ft.	53 W	12"	PE35245-12	\$33.55	\$31.20	\$28.85
			24"	PE35245-24	\$35.50	\$33.02	\$30.53
			36"	PE35245-36	\$37.70	\$35.06	\$32.42
			48"	PE35245-48	\$39.90	\$37.11	\$34.31
			60"	PE35245-60	\$42.10	\$39.15	\$36.21
Any	PE35245-XX	See Website for Pricing				18	

**See website for the following cable(s)**

50 Ohm, RG316/U Coax	PE35247						19
50 Ohm, RG400/U Coax	PE34626						20

50 Ohm, PE-B405 Coax							
Cable Dia.	Atten.*	Max Power*	Length	Model No.	1-24	25-49	50-99
0.405" dia.	4.5 dB / 100 ft.	344 W	12"	PE35249-12	\$49.55	\$46.08	\$42.61
			24"	PE35249-24	\$51.60	\$47.99	\$44.38
			36"	PE35249-36	\$53.65	\$49.89	\$46.14
			48"	PE35249-48	\$55.70	\$51.80	\$47.90
			60"	PE35249-60	\$57.70	\$53.66	\$49.62
Any	PE35249-XX	See Website for Pricing				21	

### N MALE TO 7/16 DIN MALE



Cable Dia.	Atten.*	Max Power*	Length	Model No.	1-24	25-49	50-99
<b>Standard Flexible Cable Assemblies</b>							
<b>52 Ohm, RG8A/U Coax</b>							
0.405" dia.	9 dB / 100 ft.	190 W	12"	PE35284-12	\$50.35	\$46.83	\$43.30
			24"	PE35284-24	\$51.10	\$47.52	\$43.95
			36"	PE35284-36	\$51.85	\$48.22	\$44.59
			48"	PE35284-48	\$52.60	\$48.92	\$45.24
			60"	PE35284-60	\$53.40	\$49.66	\$45.92
Any	PE35284-XX	See Website for Pricing				22	

**See website for the following cable(s)**

50 Ohm, RG58C/U Coax	PE3207						23
----------------------	--------	--	--	--	--	--	----

Cable Assemblies

\*Coax Performance at 1 GHz  
Notes: Cable assembly max frequency may be lower than connector or coax max frequency

Continued on Next Page

Continued from Previous Page

N MALE TO 7/16 DIN MALE							
							
Cable Dia.	Atten.*	Max Power*	Length	Model No.	1-24	25-49	50-99
<b>50 Ohm, RG214/U Coax</b>							
0.425" dia.	9 dB / 100 ft.	190 W	12"	PE3218-12	\$122.40	\$113.83	\$105.26
			24"	PE3218-24	\$128.15	\$119.18	\$110.21
			36"	PE3218-36	\$133.90	\$124.53	\$115.15
			48"	PE3218-48	\$139.65	\$129.87	\$120.10
			60"	PE3218-60	\$145.40	\$135.22	\$125.04
Any	PE3218-XX	See Website for Pricing					
<b>See website for the following cable(s)</b>							
50 Ohm, RG217/U Coax			PE36170				
50 Ohm, RG393/U Coax			PE34357				
50 Ohm, RG400/U Coax			PE34359				
50 Ohm, PE-C600 Coax			PE38436				

N MALE TO MINI UHF MALE							
							
Cable Dia.	Atten.*	Max Power*	Length	Model No.	1-24	25-49	50-99
<b>Standard Flexible Cable Assemblies</b>							
<b>See website for the following cable(s)</b>							
50 Ohm, RG58C/U Coax			PE3282				
<b>50 Ohm, RG142B/U Coax</b>							
0.195" dia.	13 dB / 100 ft.	650 W	12"	PE3285-12	\$29.90	\$27.81	\$25.71
			24"	PE3285-24	\$34.00	\$31.62	\$29.24
			36"	PE3285-36	\$38.15	\$35.48	\$32.81
			48"	PE3285-48	\$42.30	\$39.34	\$36.38
			60"	PE3285-60	\$46.45	\$43.20	\$39.95
Any	PE3285-XX	See Website for Pricing					
<b>See website for the following cable(s)</b>							
50 Ohm, RG223/U Coax			PE3280				
50 Ohm, RG400/U Coax			PE3288				

N MALE TO QN MALE							
							
Cable	Model No.						
<b>Standard Flexible Cable Assemblies</b>							
<b>See website for the following cable(s)</b>							
50 Ohm, RG58C/U Coax			PE38452				
50 Ohm, RG213/U Coax			PE38450				
50 Ohm, RG223/U Coax			PE38451				
50 Ohm, PE-C195 Coax			PE38453				

N MALE TO QN MALE RIGHT ANGLE							
							
Cable	Model No.						
<b>Standard Flexible Cable Assemblies</b>							
<b>See website for the following cable(s)</b>							
50 Ohm, RG58C/U Coax			PE38489				
50 Ohm, RG213/U Coax			PE38491				
50 Ohm, RG223/U Coax			PE38492				
50 Ohm, PE-C195 Coax			PE38490				

N MALE TO UMCX PLUG RIGHT ANGLE							
							
Cable	Model No.						
<b>Standard Flexible Cable Assemblies</b>							
<b>See website for the following cable(s)</b>							
50 Ohm, RG178B/U Coax			PE38813				

N MALE TO BNC MALE							
							
Cable Dia.	Atten.*	Max Power*	Length	Model No.	1-24	25-49	50-99
<b>Standard Flexible Cable Assemblies</b>							
<b>See website for the following cable(s)</b>							
52 Ohm, RG8A/U Coax			PE3252				
53.5 Ohm, RG55B/U Coax			PE3477				
<b>50 Ohm, RG58C/U Coax</b>							
0.195" dia.	20 dB / 100 ft.	44 W	12"	PE3042-12	\$30.25	\$28.13	\$26.02
			24"	PE3042-24	\$30.80	\$28.64	\$26.49
			36"	PE3042-36	\$31.35	\$29.16	\$26.96
			48"	PE3042-48	\$31.90	\$29.67	\$27.43
			60"	PE3042-60	\$32.45	\$30.18	\$27.91
Any	PE3042-XX	See Website for Pricing					
<b>50 Ohm, RG142B/U Coax</b>							
0.195" dia.	13 dB / 100 ft.	650 W	12"	PE3061-12	\$29.90	\$27.81	\$25.71
			24"	PE3061-24	\$34.05	\$31.67	\$29.28
			36"	PE3061-36	\$38.15	\$35.48	\$32.81
			48"	PE3061-48	\$42.30	\$39.34	\$36.38
			60"	PE3061-60	\$46.45	\$43.20	\$39.95
Any	PE3061-XX	See Website for Pricing					
<b>See website for the following cable(s)</b>							
50 Ohm, RG174A/U Coax			PE3246				
50 Ohm, RG188A/U Coax			PE3248				
50 Ohm, RG213/U Coax			PE3750				

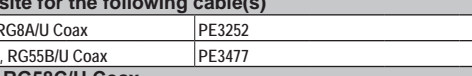
N MALE TO QN MALE RIGHT ANGLE							
							
Cable	Model No.						
<b>Standard Flexible Cable Assemblies</b>							
<b>See website for the following cable(s)</b>							
50 Ohm, RG214/U Coax			PE3097-12				
			PE3097-24				
			PE3097-36				
			PE3097-48				
			PE3097-60				
			PE3097-XX				
<b>50 Ohm, RG223/U Coax</b>							
0.216" dia.	16.5 dB / 100 ft.	53 W	12"	PE3476-12	\$27.95	\$25.99	\$24.04
			24"	PE3476-24	\$30.15	\$28.04	\$25.93
			36"	PE3476-36	\$32.40	\$30.13	\$27.86
			48"	PE3476-48	\$34.60	\$32.18	\$29.76
			60"	PE3476-60	\$36.80	\$34.22	\$31.65
Any	PE3476-XX	See Website for Pricing					
<b>50 Ohm, RG316/U Coax</b>							
0.102" dia.	30 dB / 100 ft.	160 W	12"	PE3250-12	\$36.85	\$34.27	\$31.69
			24"	PE3250-24	\$38.40	\$35.71	\$33.02
			36"	PE3250-36	\$40.75	\$37.90	\$35.05
			48"	PE3250-48	\$43.15	\$40.13	\$37.11
			60"	PE3250-60	\$45.55	\$42.36	\$39.17
Any	PE3250-XX	See Website for Pricing					
<b>See website for the following cable(s)</b>							
50 Ohm, RG316-DS Coax			PE3261				
50 Ohm, RG393/U Coax			PE3254				

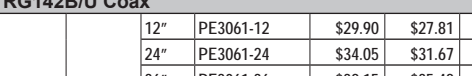
N MALE TO QN MALE RIGHT ANGLE							
							
Cable	Model No.						
<b>Standard Flexible Cable Assemblies</b>							
<b>See website for the following cable(s)</b>							
50 Ohm, RG214/U Coax			PE3097-12				
			PE3097-24				
			PE3097-36				
			PE3097-48				
			PE3097-60				
			PE3097-XX				
<b>50 Ohm, RG223/U Coax</b>							
0.216" dia.	16.5 dB / 100 ft.	53 W	12"	PE3476-12	\$27.95	\$25.99	\$24.04
			24"	PE3476-24	\$30.15	\$28.04	\$25.93
			36"	PE3476-36	\$32.40	\$30.13	\$27.86
			48"	PE3476-48	\$34.60	\$32.18	\$29.76
			60"	PE3476-60	\$36.80	\$34.22	\$31.65
Any	PE3476-XX	See Website for Pricing					
<b>50 Ohm, RG316/U Coax</b>							
0.102" dia.	30 dB / 100 ft.	160 W	12"	PE3250-12	\$36.85	\$34.27	\$31.69
			24"	PE3250-24	\$38.40	\$35.71	\$33.02
			36"	PE3250-36	\$40.75	\$37.90	\$35.05
			48"	PE3250-48	\$43.15	\$40.13	\$37.11
			60"	PE3250-60	\$45.55	\$42.36	\$39.17
Any	PE3250-XX	See Website for Pricing					
<b>See website for the following cable(s)</b>							
50 Ohm, RG316-DS Coax			PE3261				
50 Ohm, RG393/U Coax			PE3254				

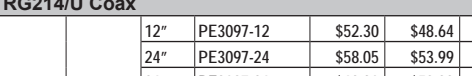
N MALE TO QN MALE RIGHT ANGLE							
							
Cable	Model No.						
<b>Standard Flexible Cable Assemblies</b>							
<b>See website for the following cable(s)</b>							
50 Ohm, RG214/U Coax			PE3097-12				
			PE3097-24				
			PE3097-36				
			PE3097-48				
			PE3097-60				
			PE3097-XX				
<b>50 Ohm, RG223/U Coax</b>							
0.216" dia.	16.5 dB / 100 ft.	53 W	12"	PE3476-12	\$27.95	\$25.99	\$24.04
			24"	PE3476-24	\$30.15	\$28.04	\$25.93
			36"	PE3476-36	\$32.40	\$30.13	\$27.86
			48"	PE3476-48	\$34.60	\$32.18	\$29.76
			60"	PE3476-60	\$36.80	\$34.22	\$31.65
Any	PE3476-XX	See Website for Pricing					
<b>50 Ohm, RG316/U Coax</b>							
0.102" dia.	30 dB / 100 ft.	160 W	12"	PE3250-12	\$36.85	\$34.27	\$31.69
			24"	PE3250-24	\$38.40	\$35.71	\$33.02
			36"	PE3250-36	\$40.75	\$37.90	\$35.05
			48"	PE3250-48	\$43.15	\$40.13	\$37.11
			60"	PE3250-60	\$45.55	\$42.36	\$39.17
Any	PE3250-XX	See Website for Pricing					
<b>See website for the following cable(s)</b>							
50 Ohm, RG316-DS Coax			PE3261				
50 Ohm, RG393/U Coax			PE3254				

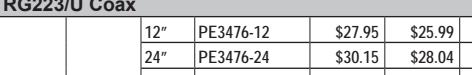
N MALE TO QN MALE RIGHT ANGLE							
							
Cable	Model No.						
<b>Standard Flexible Cable Assemblies</b>							
<b>See website for the following cable(s)</b>							
50 Ohm, RG214/U Coax			PE3097-12				
			PE3097-24				
			PE3097-36				
			PE3097-48				
			PE3097-60				
			PE3097-XX				
<b>50 Ohm, RG223/U Coax</b>							
0.216" dia.	16.5 dB / 100 ft.	53 W	12"	PE3476-12	\$27.95	\$25.99	\$24.04
			24"	PE3476-24	\$30.15	\$28.04	\$25.93
			36"	PE3476-36	\$32.40	\$30.13	\$27.86
			48"	PE3476-48	\$34.60	\$32.18	\$29.76
			60"	PE3476-60	\$36.80	\$34.22	\$31.65
Any	PE3476-XX	See Website for Pricing					
<b>50 Ohm, RG316/U Coax</b>							
0.102" dia.	30 dB / 100 ft.	160 W	12"	PE3250-12	\$36.85	\$34.27	\$31.69
			24"	PE3250-24	\$38.40	\$35.71	\$33.02
			36"	PE3250-36	\$40.75	\$37.90	\$35.05
			48"	PE3250-48	\$43.15	\$40.13	\$37.11
			60"	PE3250-60	\$45.55	\$42.36	\$39.17
Any	PE3250-XX	See Website for Pricing					
<b>See website for the following cable(s)</b>							
50 Ohm, RG316-DS Coax			PE3261				
50 Ohm, RG393/U Coax			PE3254				

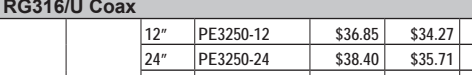
N MALE TO QN MALE RIGHT ANGLE							
							
Cable	Model No.						
<b>Standard Flexible Cable Assemblies</b>							
<b>See website for the following cable(s)</b>							
50 Ohm, RG214/U Coax			PE3097-12				
			PE3097-24				
			PE3097-36				
			PE3097-48				
			PE3097-60				
			PE3097-XX				
<b>50 Ohm, RG223/U Coax</b>							
0.216" dia.	16.5 dB / 100 ft.	53 W	12"	PE3476-12	\$27.95	\$25.99	\$24.04
			24"	PE3476-24	\$30.15	\$28.04	\$25.93
			36"	PE3476-36	\$32.40	\$30.13	\$27.86
			48"	PE3476-48	\$34.60	\$32.18	\$29.76
			60"	PE3476-60	\$36.80	\$34.22	\$31.65
Any	PE3476-XX	See Website for Pricing					
<b>50 Ohm, RG316/U Coax</b>							
0.102" dia.	30 dB / 100 ft.	160 W	12"	PE3250-12	\$36.85	\$34.27	\$31.69
			24"	PE3250-24	\$38.40	\$35.71	\$33.02
			36"	PE3250-36	\$40.75	\$37.90	\$35.05
			48"	PE3250-48	\$43.15	\$40.13	\$37.11
			60"	PE3250-60	\$45.55	\$42.36	\$39.17
Any	PE3250-XX	See Website for Pricing					
<b>See website for the following cable(s)</b>							
50 Ohm, RG316-DS Coax			PE3261				
50 Ohm, RG393/U Coax			PE3254				

Cable Assemblies

\*Coax Performance at 1 GHz  
Notes: Cable assembly max frequency may be lower than connector or coax max frequency

Continued on Next Page



Continued from Previous Page

### N MALE TO BNC MALE



Cable Dia.	Atten.*	Max Power*	Length	Model No.	1-24	25-49	50-99
<b>50 Ohm, RG400/U Coax</b>							
0.195" dia.	13 dB / 100 ft.	650 W	12"	PE3874-12	\$35.60	\$33.11	\$30.62
			24"	PE3874-24	\$41.00	\$38.13	\$35.26
			36"	PE3874-36	\$46.45	\$43.20	\$39.95
			48"	PE3874-48	\$51.90	\$48.27	\$44.63
			60"	PE3874-60	\$56.30	\$52.36	\$48.42
		Any	PE3874-XX	See Website for Pricing			

**See website for the following cable(s)**

50 Ohm, PE-B405 Coax	PE3256
50 Ohm, PE-C195 Coax	PE36065
50 Ohm, PE-C240 Coax	PE35269

### N MALE TO NMO MOUNT CONNECTOR

NMO MOUNT REQUIRES 3/4" HOLE, 1 1/8"-18 THREAD AND INSTALLS FROM ABOVE.



Cable	Model No.
<b>Standard Flexible Cable Assemblies</b>	
<b>See website for the following cable(s)</b>	
50 Ohm, RG58C/U Coax	PE37850

### N FEMALE TO QN MALE



Cable	Model No.
<b>Standard Flexible Cable Assemblies</b>	
<b>See website for the following cable(s)</b>	
50 Ohm, RG223/U Coax	PE38455

### N FEMALE TO QN MALE RIGHT ANGLE



Cable	Model No.
<b>Standard Flexible Cable Assemblies</b>	
<b>See website for the following cable(s)</b>	
50 Ohm, RG223/U Coax	PE38496
50 Ohm, PE-C195 Coax	PE38494

### N FEMALE TO NMO MOUNT CONNECTOR

NMO MOUNT REQUIRES 3/4" HOLE, 1 1/8"-18 THREAD AND INSTALLS FROM ABOVE.



Cable	Model No.
<b>Standard Flexible Cable Assemblies</b>	
<b>See website for the following cable(s)</b>	
50 Ohm, RG58C/U Coax	PE37851

### N FEMALE BULKHEAD TO MMCX PLUG

SEE MOUNTING HOLE SECTION ON PAGE 246



Cable	Model No.
<b>Precision Formable Cable Assemblies</b>	
<b>Please see precision section, page 6-29</b>	
50 Ohm, PE-SR405FL Coax	PE39450
50 Ohm, PE-SR405FLJ Jacketed Coax	PE39464

### N FEMALE BULKHEAD TO 75 OHM MCX JACK

SEE MOUNTING HOLE SECTION ON PAGE 246



Cable	Model No.
<b>Precision Formable Cable Assemblies</b>	
<b>Please see precision section, page 6-29</b>	
50 Ohm, PE-SR405FL Coax	PE39449
50 Ohm, PE-SR405FLJ Jacketed Coax	PE39463

### TNC MALE TO TNC MALE



Cable Dia.	Atten.*	Max Power*	Length	Model No.	1-24	25-49	50-99
<b>Precision Flexible Cable Assemblies</b>							
<b>Please see precision section, page 6-29</b>							
50 Ohm, 150 Series Coax				PE35423			
<b>Precision Formable Cable Assemblies</b>							
<b>Please see precision section, page 6-29</b>							
50 Ohm, PE-SR402FL Coax				PE39479	15		
50 Ohm, PE-SR402FLJ Jacketed Coax				PE39493	16		
50 Ohm, PE-SR405FL Coax				PE39471	17		
50 Ohm, PE-SR405FLJ Jacketed Coax				PE39485	18		
<b>Standard Flexible Cable Assemblies</b>							
<b>See website for the following cable(s)</b>							
52 Ohm, RG8A/U Coax				PE3418	19		
50 Ohm, RG8X Coax				PE35671	20		
53.5 Ohm, RG55B/U Coax				PE3504	21		
<b>50 Ohm, RG58C/U Coax</b>							
0.195" dia.	20 dB / 100 ft.	44 W	12"	PE3394-12	\$31.00	\$28.83	\$26.66
			24"	PE3394-24	\$31.55	\$29.34	\$27.13
			36"	PE3394-36	\$32.10	\$29.85	\$27.61
			48"	PE3394-48	\$32.65	\$30.36	\$28.08
			60"	PE3394-60	\$33.20	\$30.88	\$28.55
			Any	PE3394-XX	See Website for Pricing		
<b>50 Ohm, RG142B/U Coax</b>							
0.195" dia.	13 dB / 100 ft.	650 W	12"	PE3544-12	\$33.30	\$30.97	\$28.64
			24"	PE3544-24	\$37.45	\$34.83	\$32.21
			36"	PE3544-36	\$41.60	\$38.69	\$35.78
			48"	PE3544-48	\$45.75	\$42.55	\$39.35
			60"	PE3544-60	\$49.90	\$46.41	\$42.91
			Any	PE3544-XX	See Website for Pricing		
<b>See website for the following cable(s)</b>							
50 Ohm, RG174A/U Coax				PE3425	24		
50 Ohm, RG188A/U Coax				PE3434	25		
50 Ohm, RG213/U Coax				PE3421	26		

Cable Assemblies

\*Coax Performance at 1 GHz  
Notes: Cable assembly max frequency may be lower than connector or coax max frequency

Continued on Next Page

ROHS & REACH COMPLIANT. CUSTOM-LENGTH CABLE ASSEMBLIES MAY BE ORDERED ON OUR WEBSITE.

Continued from Previous Page

### TNC MALE TO TNC MALE



Cable Dia.	Atten.*	Max Power*	Length	Model No.	1-24	25-49	50-99
<b>50 Ohm, RG214/U Coax</b>							
0.425" dia.	9 dB / 100 ft.	190 W	12"	PE3435-12	\$64.60	\$60.08	\$55.56
			24"	PE3435-24	\$70.35	\$65.43	\$60.50
			36"	PE3435-36	\$76.10	\$70.77	\$65.45
			48"	PE3435-48	\$81.85	\$76.12	\$70.39
			60"	PE3435-60	\$87.60	\$81.47	\$75.34
Any	PE3435-XX	See Website for Pricing					
<b>50 Ohm, RG223/U Coax</b>							
0.216" dia.	16.5 dB / 100 ft.	53 W	12"	PE3414-12	\$31.40	\$29.20	\$27.00
			24"	PE3414-24	\$33.60	\$31.25	\$28.90
			36"	PE3414-36	\$35.80	\$33.29	\$30.79
			48"	PE3414-48	\$38.00	\$35.34	\$32.68
			60"	PE3414-60	\$40.25	\$37.43	\$34.62
Any	PE3414-XX	See Website for Pricing					
<b>See website for the following cable(s)</b>							
50 Ohm, RG303/U Coax				PE33013			
<b>50 Ohm, RG316/U Coax</b>							
0.102" dia.	30 dB / 100 ft.	160 W	12"	PE3747-12	\$40.80	\$37.94	\$35.09
			24"	PE3747-24	\$42.20	\$39.25	\$36.29
			36"	PE3747-36	\$43.75	\$40.69	\$37.63
			48"	PE3747-48	\$45.15	\$41.99	\$38.83
			60"	PE3747-60	\$46.55	\$43.29	\$40.03
Any	PE3747-XX	See Website for Pricing					
<b>See website for the following cable(s)</b>							
50 Ohm, RG316-DS Coax				PE34316			
50 Ohm, RG393/U Coax				PE33185			
<b>50 Ohm, RG400/U Coax</b>							
0.195" dia.	13 dB / 100 ft.	650 W	12"	PE3608-12	\$38.85	\$36.13	\$33.41
			24"	PE3608-24	\$42.75	\$39.76	\$36.77
			36"	PE3608-36	\$46.65	\$43.38	\$40.12
			48"	PE3608-48	\$50.60	\$47.06	\$43.52
			60"	PE3608-60	\$54.50	\$50.69	\$46.87
Any	PE3608-XX	See Website for Pricing					
<b>See website for the following cable(s)</b>							
50 Ohm, PE-C195 Coax				PE36555			
50 Ohm, PE-C240 Coax				PE35997			
50 Ohm, PE-C300 Coax				PE35100			
50 Ohm, PE-C400 Coax				PE35886			
<b>75 Ohm, RG59B/U Coax</b>							
0.242" dia.	11.5 dB / 100 ft.	77 W	12"	PE3402-12	\$26.75	\$24.88	\$23.01
			24"	PE3402-24	\$27.50	\$25.58	\$23.65
			36"	PE3402-36	\$28.25	\$26.27	\$24.30
			48"	PE3402-48	\$28.95	\$26.92	\$24.90
			60"	PE3402-60	\$29.70	\$27.62	\$25.54
Any	PE3402-XX	See Website for Pricing					
<b>See website for the following cable(s)</b>							
75 Ohm, RG179B/U Coax				PE3430			
<b>Standard Formable Cable Assemblies</b>							
<b>See website for the following cable(s)</b>							
50 Ohm, PE-SR401FL Coax				PE34282			
50 Ohm, PE-SR402FL Coax				PE3466			
<b>Standard Semirigid Cable Assemblies</b>							
<b>See website for the following cable(s)</b>							
50 Ohm, PE-SR402AL Coax				PE34279			
50 Ohm, RG401/U Coax				PE34271			
50 Ohm, RG402/U Coax				PE3074			

### TNC MALE TO TNC MALE RIGHT ANGLE



Cable	Model No.
<b>Precision Formable Cable Assemblies</b>	
<b>Please see precision section, page 6-29</b>	
50 Ohm, PE-SR402FL Coax	PE39481
50 Ohm, PE-SR402FLJ Jacketed Coax	PE39495
50 Ohm, PE-SR405FL Coax	PE39473
50 Ohm, PE-SR405FLJ Jacketed Coax	PE39487

### TNC MALE TO TNC FEMALE



Cable	Model No.
<b>Precision Formable Cable Assemblies</b>	
<b>Please see precision section, page 6-29</b>	
50 Ohm, PE-SR402FL Coax	PE39482
50 Ohm, PE-SR402FLJ Jacketed Coax	PE39496
50 Ohm, PE-SR405FL Coax	PE39474
50 Ohm, PE-SR405FLJ Jacketed Coax	PE39488

### TNC MALE TO REVERSE POLARITY TNC MALE



Cable Dia.	Atten.*	Max Power*	Length	Model No.	1-24	25-49	50-99
<b>Standard Flexible Cable Assemblies</b>							
<b>See website for the following cable(s)</b>							
50 Ohm, RG58C/U Coax				PE35228			
50 Ohm, RG142B/U Coax				PE35230			
<b>50 Ohm, RG223/U Coax</b>							
0.216" dia.	16.5 dB / 100 ft.	53 W	12"	PE35236-12	\$31.50	\$29.30	\$27.09
			24"	PE35236-24	\$33.70	\$31.34	\$28.98
			36"	PE35236-36	\$35.90	\$33.39	\$30.87
			48"	PE35236-48	\$38.10	\$35.43	\$32.77
			60"	PE35236-60	\$40.35	\$37.53	\$34.70
Any	PE35236-XX	See Website for Pricing					
<b>See website for the following cable(s)</b>							
50 Ohm, RG316/U Coax				PE35238			

### TNC MALE RIGHT ANGLE TO TNC MALE RIGHT ANGLE



Cable	Model No.
<b>Precision Formable Cable Assemblies</b>	
<b>Please see precision section, page 6-29</b>	
50 Ohm, PE-SR402FL Coax	PE39480
50 Ohm, PE-SR402FLJ Jacketed Coax	PE39494
50 Ohm, PE-SR405FL Coax	PE39472
50 Ohm, PE-SR405FLJ Jacketed Coax	PE39486

Cable Assemblies

\*Coax Performance at 1 GHz  
Notes: Cable assembly max frequency may be lower than connector or coax max frequency

The Telstar 1 satellite, launched in July 1962, carried the first transatlantic live television pictures via satellite.



Free Freight Available via UPS Ground to USA & Canada



Real-Time Stock Levels & Pricing On Our WebSite



Toll-Free Technical Support (866) 727-8376



Same-Day Shipping, Even Custom Cable Assemblies

Cable Assemblies

\*Coax Performance at 1 GHz  
Notes: Cable assembly max frequency may be lower than connector or coax max frequency



Cable Dia.	Atten.*	Max Power*	Length	Model No.	1-24	25-49	50-99
------------	---------	------------	--------	-----------	------	-------	-------

**Standard Flexible Cable Assemblies**

**50 Ohm, RG58/U Coax**

0.195" dia.	20 dB / 100 ft.	44 W	12"	PE3497-12	\$27.75	\$25.81	\$23.87
			24"	PE3497-24	\$28.30	\$26.32	\$24.34
			36"	PE3497-36	\$28.85	\$26.83	\$24.81
			48"	PE3497-48	\$29.35	\$27.30	\$25.24
			60"	PE3497-60	\$29.90	\$27.81	\$25.71
Any	PE3497-XX	See Website for Pricing					

**50 Ohm, RG142B/U Coax**

0.195" dia.	13 dB / 100 ft.	650 W	12"	PE3551-12	\$28.10	\$26.13	\$24.17
			24"	PE3551-24	\$32.25	\$29.99	\$27.74
			36"	PE3551-36	\$36.40	\$33.85	\$31.30
			48"	PE3551-48	\$40.55	\$37.71	\$34.87
			60"	PE3551-60	\$44.65	\$41.52	\$38.40
Any	PE3551-XX	See Website for Pricing					

**See website for the following cable(s)**

50 Ohm, RG174A/U Coax	PE34506
50 Ohm, RG178B/U Coax	PE39255
50 Ohm, RG213/U Coax	PE33969
50 Ohm, RG214/U Coax	PE33701

**50 Ohm, RG223/U Coax**

0.216" dia.	16.5 dB / 100 ft.	53 W	12"	PE3498-12	\$26.20	\$24.37	\$22.53
			24"	PE3498-24	\$28.40	\$26.41	\$24.42
			36"	PE3498-36	\$30.60	\$28.46	\$26.32
			48"	PE3498-48	\$32.80	\$30.50	\$28.21
			60"	PE3498-60	\$35.00	\$32.55	\$30.10
Any	PE3498-XX	See Website for Pricing					

**See website for the following cable(s)**

50 Ohm, RG316/U Coax	PE33383
----------------------	---------

**50 Ohm, RG400/U Coax**

0.195" dia.	13 dB / 100 ft.	650 W	12"	PE33535-12	\$33.00	\$30.69	\$28.38
			24"	PE33535-24	\$36.95	\$34.36	\$31.78
			36"	PE33535-36	\$40.80	\$37.94	\$35.09
			48"	PE33535-48	\$44.75	\$41.62	\$38.49
			60"	PE33535-60	\$48.65	\$45.24	\$41.84
Any	PE33535-XX	See Website for Pricing					

**TNC FEMALE BULKHEAD TO UMCX PLUG RIGHT ANGLE**  
SEE MOUNTING HOLE SECTION ON PAGE 246



Cable	Model No.
-------	-----------

**Standard Flexible Cable Assemblies**

**See website for the following cable(s)**

50 Ohm, RG178B/U Coax	PE38304
-----------------------	---------

**TNC FEMALE BULKHEAD TO MMCX PLUG RIGHT ANGLE**  
SEE MOUNTING HOLE SECTION ON PAGE 246



Cable	Model No.
-------	-----------

**Precision Formable Cable Assemblies**

**Please see precision section, page 6-29**

50 Ohm, PE-SR405FL Coax	PE39478	11
50 Ohm, PE-SR405FLJ Jacketed Coax	PE39492	12

**TNC FEMALE BULKHEAD TO MMCX PLUG RIGHT ANGLE**  
SEE MOUNTING HOLE SECTION ON PAGE 246



Cable Dia.	Atten.*	Max Power*	Length	Model No.	1-24	25-49	50-99
------------	---------	------------	--------	-----------	------	-------	-------

**Standard Flexible Cable Assemblies**

**50 Ohm, RG188A/U Coax**

0.110" dia.	30 dB / 100 ft.	160 W	12"	PE35635-12	\$53.20	\$49.48	\$45.75
			24"	PE35635-24	\$54.90	\$51.06	\$47.21
			36"	PE35635-36	\$56.55	\$52.59	\$48.63
			48"	PE35635-48	\$58.25	\$54.17	\$50.10
			60"	PE35635-60	\$59.95	\$55.75	\$51.56
Any	PE35635-XX	See Website for Pricing					

**TNC FEMALE BULKHEAD TO MCX PLUG RIGHT ANGLE**  
SEE MOUNTING HOLE SECTION ON PAGE 246



Cable Dia.	Atten.*	Max Power*	Length	Model No.	1-24	25-49	50-99
------------	---------	------------	--------	-----------	------	-------	-------

**Standard Flexible Cable Assemblies**

**50 Ohm, RG174A/U Coax**

0.100" dia.	31 dB / 100 ft.	16 W	12"	PE33799-12	\$44.50	\$41.39	\$38.27
			24"	PE33799-24	\$44.90	\$41.76	\$38.61
			36"	PE33799-36	\$45.35	\$42.18	\$39.00
			48"	PE33799-48	\$45.80	\$42.59	\$39.39
			60"	PE33799-60	\$46.20	\$42.97	\$39.73
Any	PE33799-XX	See Website for Pricing					

**TNC FEMALE BULKHEAD TO 75 OHM MCX JACK**  
SEE MOUNTING HOLE SECTION ON PAGE 246



Cable	Model No.
-------	-----------

**Precision Formable Cable Assemblies**

**Please see precision section, page 6-29**

50 Ohm, PE-SR405FL Coax	PE39477	15
50 Ohm, PE-SR405FLJ Jacketed Coax	PE39491	16

**REVERSE POLARITY TNC MALE TO BNC MALE**



Cable	Model No.
-------	-----------

**Standard Flexible Cable Assemblies**

**See website for the following cable(s)**

50 Ohm, RG58C/U Coax	PE35229	17
----------------------	---------	----

The TNC connector, which stands for "Threaded Neill Concelman", is a threaded version of the BNC connector.

### REVERSE POLARITY TNC FEMALE BULKHEAD TO UMCX PLUG RIGHT ANGLE

SEE MOUNTING HOLE SECTION ON PAGE 246



Cable Model No.

Standard Flexible Cable Assemblies

See website for the following cable(s)

50 Ohm, RG178B/U Coax	PE38303	1
-----------------------	---------	---

### 7/16 DIN MALE TO 7/16 DIN MALE



Cable Dia.	Atten.*	Max Power*	Length	Model No.	1-24	25-49	50-99
------------	---------	------------	--------	-----------	------	-------	-------

Standard Flexible Cable Assemblies

See website for the following cable(s)

50 Ohm, RG217/U Coax	PE36134	2
50 Ohm, RG218/U Coax	PE35900	3
50 Ohm, RG393/U Coax	PE3205	4
50 Ohm, PE-C195 Coax	PE37952	5
50 Ohm, PE-C400 Coax	PE37954	6
50 Ohm, PE-C600 Coax	PE37955	7

Standard Formable Cable Assemblies

See website for the following cable(s)

50 Ohm, 1/2" Helical Coax	PE37971	8
---------------------------	---------	---

Standard Flexible Cable Assemblies

50 Ohm, 1/2" Flexible Coax, Low PIM, Low Loss

Cable Dia.	Atten.*	Max Power*	Length	Model No.	1-24	25-49	50-99
0.63" dia.	2.1 dB / 100 ft.	- W	36"	PE39802-36			
			48"	PE39802-48			
			72"	PE39802-72			
			96"	PE39802-96			
			120"	PE39802-120			
			144"	PE39802-144			
			168"	PE39802-168			
			192"	PE39802-192			
			240"	PE39802-240			
			Any	PE39802-XX	See Website for Pricing		

50 Ohm, 1/2" Super Flexible Coax, Low PIM, Low Loss

Cable Dia.	Atten.*	Max Power*	Length	Model No.	1-24	25-49	50-99
0.53" dia.	3.3 dB / 100 ft.	- W	36"	PE39803-36			
			48"	PE39803-48			
			72"	PE39803-72			
			96"	PE39803-96			
			120"	PE39803-120			
			144"	PE39803-144			
			168"	PE39803-168			
			192"	PE39803-192			
			240"	PE39803-240			
			Any	PE39803-XX	See Website for Pricing		

### 7/16 DIN MALE TO 7/16 DIN MALE RIGHT ANGLE



Cable Model No.

Standard Flexible Cable Assemblies

See website for the following cable(s)

50 Ohm, RG393/U Coax	PE36657	11
----------------------	---------	----

Standard Formable Cable Assemblies

See website for the following cable(s)

50 Ohm, 1/2" Helical Coax	PE37973	12
---------------------------	---------	----

### 7/16 DIN MALE TO 7/16 DIN FEMALE



Cable Model No.

Standard Flexible Cable Assemblies

See website for the following cable(s)

50 Ohm, PE-C400 Coax	PE37962	13
50 Ohm, PE-C600 Coax	PE37963	14

Standard Formable Cable Assemblies

See website for the following cable(s)

50 Ohm, 1/2" Helical Coax	PE37972	15
---------------------------	---------	----

### UHF MALE TO UHF MALE



Cable Dia.	Atten.*	Max Power*	Length	Model No.	1-24	25-49	50-99
------------	---------	------------	--------	-----------	------	-------	-------

Standard Flexible Cable Assemblies

See website for the following cable(s)

52 Ohm, RG8A/U Coax	PE3623	16
---------------------	--------	----

50 Ohm, RG58C/U Coax

Cable Dia.	Atten.*	Max Power*	Length	Model No.	1-24	25-49	50-99
0.195" dia.	20 dB / 100 ft.	44 W	12"	PE3015-12	\$25.40	\$23.62	\$21.84
			24"	PE3015-24	\$25.95	\$24.13	\$22.32
			36"	PE3015-36	\$26.50	\$24.65	\$22.79
			48"	PE3015-48	\$27.00	\$25.11	\$23.22
			60"	PE3015-60	\$27.55	\$25.62	\$23.69
			Any	PE3015-XX	See Website for Pricing		

See website for the following cable(s)

50 Ohm, RG213/U Coax	PE3635	18
50 Ohm, RG214/U Coax	PE3796	19
50 Ohm, RG223/U Coax	PE3845	20
50 Ohm, RG393/U Coax	PE33267	21
50 Ohm, PE-B405 Coax	PE3159	22
50 Ohm, PE-C195 Coax	PE38632	23
75 Ohm, RG59B/U Coax	PE3580	24

### UHF MALE TO BNC MALE



Cable Dia.	Atten.*	Max Power*	Length	Model No.	1-24	25-49	50-99
------------	---------	------------	--------	-----------	------	-------	-------

Standard Flexible Cable Assemblies

50 Ohm, RG58C/U Coax

Cable Dia.	Atten.*	Max Power*	Length	Model No.	1-24	25-49	50-99
0.195" dia.	20 dB / 100 ft.	44 W	12"	PE3057-12	\$24.95	\$23.20	\$21.46
			24"	PE3057-24	\$25.50	\$23.72	\$21.93
			36"	PE3057-36	\$26.00	\$24.18	\$22.36
			48"	PE3057-48	\$26.55	\$24.69	\$22.83
			60"	PE3057-60	\$27.10	\$25.20	\$23.31
			Any	PE3057-XX	See Website for Pricing		

See website for the following cable(s)

93 Ohm, RG62A/U Coax	PE34587	26
50 Ohm, RG142B/U Coax	PE3898	27
50 Ohm, RG214/U Coax	PE33438	28

50 Ohm, RG223/U Coax

Cable Dia.	Atten.*	Max Power*	Length	Model No.	1-24	25-49	50-99
0.216" dia.	16.5 dB / 100 ft.	53 W	12"	PE3803-12	\$23.20	\$21.58	\$19.95
			24"	PE3803-24	\$25.25	\$23.48	\$21.72
			36"	PE3803-36	\$27.45	\$25.53	\$23.61
			48"	PE3803-48	\$29.65	\$27.57	\$25.50
			60"	PE3803-60	\$31.85	\$29.62	\$27.39
			Any	PE3803-XX	See Website for Pricing		

See website for the following cable(s)

50 Ohm, RG225/U Coax	PE34589	30
----------------------	---------	----

\*Coax Performance at 1 GHz  
Notes: Cable assembly max frequency may be lower than connector or coax max frequency

Continued on Next Page



Continued from Previous Page

### UHF MALE TO BNC MALE



Cable Dia.	Atten.*	Max Power*	Length	Model No.	1-24	25-49	50-99
<b>50 Ohm, RG400/U Coax</b>							
0.195" dia.	13 dB / 100 ft.	650 W	12"	PE3231-12	\$30.65	\$28.50	\$26.36
			24"	PE3231-24	\$36.05	\$33.53	\$31.00
			36"	PE3231-36	\$41.50	\$38.60	\$35.69
			48"	PE3231-48	\$46.95	\$43.66	\$40.38
			60"	PE3231-60	\$52.35	\$48.69	\$45.02
		Any	PE3231-XX	See Website for Pricing			
<b>See website for the following cable(s)</b>							
50 Ohm, PE-C195 Coax				PE38674			
75 Ohm, RG59B/U Coax				PE3543			

### MINI UHF MALE TO MINI UHF MALE



Cable	Model No.
<b>Standard Flexible Cable Assemblies</b>	
<b>See website for the following cable(s)</b>	
50 Ohm, RG58C/U Coax	PE3258
50 Ohm, RG142B/U Coax	PE3263

### FME JACK TO FME JACK



Cable	Model No.
<b>Standard Flexible Cable Assemblies</b>	
<b>See website for the following cable(s)</b>	
50 Ohm, RG58C/U Coax	PE34856

### FME PLUG TO NMO MOUNT CONNECTOR

NMO MOUNT REQUIRES 3/4" HOLE, 1 1/8"-18 THREAD AND INSTALLS FROM ABOVE.



Cable	Model No.
<b>Standard Flexible Cable Assemblies</b>	
<b>See website for the following cable(s)</b>	
50 Ohm, RG58C/U Coax	PE37842

### FME JACK TO BNC MALE



Cable	Model No.
<b>Standard Flexible Cable Assemblies</b>	
<b>See website for the following cable(s)</b>	
50 Ohm, RG58C/U Coax	PE34862

The FME connector is "For Mobile Equipment". It offers excellent performance from DC to 2GHz.

### FME JACK TO NMO MOUNT CONNECTOR

NMO MOUNT REQUIRES 3/4" HOLE, 1 1/8"-18 THREAD AND INSTALLS FROM ABOVE.



Cable	Model No.
<b>Standard Flexible Cable Assemblies</b>	
<b>See website for the following cable(s)</b>	
50 Ohm, RG58C/U Coax	PE37843

### FME JACK BULKHEAD TO UMCX PLUG

SEE MOUNTING HOLE SECTION ON PAGE 246



Cable	Model No.
<b>Standard Flexible Cable Assemblies</b>	
<b>See website for the following cable(s)</b>	
50 Ohm, 1.13mm Coax	PE38857
	PE38858

### SMC PLUG TO SMC PLUG



Cable Dia.	Atten.*	Max Power*	Length	Model No.	1-24	25-49	50-99
<b>Standard Flexible Cable Assemblies</b>							
<b>See website for the following cable(s)</b>							
50 Ohm, RG58C/U Coax				PE33641			
<b>50 Ohm, RG174A/U Coax</b>							
0.100" dia.	31 dB / 100 ft.	16 W	12"	PE3883-12	\$32.20	\$29.95	\$27.69
			24"	PE3883-24	\$32.65	\$30.36	\$28.08
			36"	PE3883-36	\$33.05	\$30.74	\$28.42
			48"	PE3883-48	\$33.50	\$31.16	\$28.81
			60"	PE3883-60	\$33.95	\$31.57	\$29.20
		Any	PE3883-XX	See Website for Pricing			
<b>See website for the following cable(s)</b>							
50 Ohm, RG178B/U Coax				PE3902			
50 Ohm, RG188A/U Coax				PE3595			
50 Ohm, RG188-DS Coax				PE33154			
50 Ohm, RG196A/U Coax				PE3596			
<b>50 Ohm, RG316/U Coax</b>							
0.102" dia.	30 dB / 100 ft.	160 W	12"	PE3808-12	\$34.15	\$31.76	\$29.37
			24"	PE3808-24	\$36.55	\$33.99	\$31.43
			36"	PE3808-36	\$38.95	\$36.22	\$33.50
			48"	PE3808-48	\$41.35	\$38.46	\$35.56
			60"	PE3808-60	\$43.75	\$40.69	\$37.63
		Any	PE3808-XX	See Website for Pricing			
<b>See website for the following cable(s)</b>							
50 Ohm, RG316-DS Coax				PE34721			

### SMC PLUG TO SMC PLUG RIGHT ANGLE



Cable	Model No.
<b>Standard Flexible Cable Assemblies</b>	
<b>See website for the following cable(s)</b>	
50 Ohm, RG174A/U Coax	PE33556
50 Ohm, RG178B/U Coax	PE34492
50 Ohm, RG188A/U Coax	PE3600
50 Ohm, RG196A/U Coax	PE3601

Continued on Next Page

Cable Assemblies

\*Coax Performance at 1 GHz  
Notes: Cable assembly max frequency may be lower than connector or coax max frequency

Continued from Previous Page

### SMC PLUG TO SMC PLUG RIGHT ANGLE



Cable Model No.

50 Ohm, RG316/U Coax	PE33363	1
----------------------	---------	---

### SMC PLUG TO SMC JACK BULKHEAD

SEE MOUNTING HOLE SECTION ON PAGE 246



Cable Model No.

Standard Flexible Cable Assemblies

See website for the following cable(s)

50 Ohm, RG58C/U Coax	PE34503	2
50 Ohm, RG174A/U Coax	PE33580	3
50 Ohm, RG178B/U Coax	PE33352	4
50 Ohm, RG316/U Coax	PE33690	5

### SMC PLUG RIGHT ANGLE TO SMC PLUG RIGHT ANGLE



Cable Model No.

Standard Flexible Cable Assemblies

See website for the following cable(s)

50 Ohm, RG58C/U Coax	PE33643	6
50 Ohm, RG174A/U Coax	PE3918	7
50 Ohm, RG178B/U Coax	PE3765	8
50 Ohm, RG188A/U Coax	PE3597	9
50 Ohm, RG316/U Coax	PE3919	10
50 Ohm, RG316-DS Coax	PE34462	11

### SMC PLUG RIGHT ANGLE TO SMC JACK BULKHEAD

SEE MOUNTING HOLE SECTION ON PAGE 246



Cable Model No.

Standard Flexible Cable Assemblies

See website for the following cable(s)

50 Ohm, RG174A/U Coax	PE34078	12
-----------------------	---------	----

### SMC PLUG TO BNC MALE



Cable Dia.	Atten.*	Max Power*	Length	Model No.	1-24	25-49	50-99
------------	---------	------------	--------	-----------	------	-------	-------

Standard Flexible Cable Assemblies

See website for the following cable(s)

50 Ohm, RG58C/U Coax	PE3244	13
50 Ohm, RG142B/U Coax	PE3240	14

0.100" dia.	31 dB / 100 ft.	16 W	12"	PE3660-12	\$30.55	\$28.41	\$26.27
			24"	PE3660-24	\$30.95	\$28.78	\$26.62
			36"	PE3660-36	\$31.40	\$29.20	\$27.00
			48"	PE3660-48	\$31.80	\$29.57	\$27.35
			60"	PE3660-60	\$32.25	\$29.99	\$27.74
			Any	PE3660-XX	See Website for Pricing		

### SMC PLUG TO BNC MALE



Cable Dia.	Atten.*	Max Power*	Length	Model No.	1-24	25-49	50-99
------------	---------	------------	--------	-----------	------	-------	-------

See website for the following cable(s)

50 Ohm, RG188A/U Coax	PE3641	16
50 Ohm, RG223/U Coax	PE3238	17
50 Ohm, RG316/U Coax	PE3849	18
50 Ohm, RG316-DS Coax	PE3437	19

### SMC JACK BULKHEAD TO UMCX PLUG RIGHT ANGLE

SEE MOUNTING HOLE SECTION ON PAGE 246



Cable Model No.

Standard Flexible Cable Assemblies

See website for the following cable(s)

50 Ohm, RG178B/U Coax	PE39035	20
-----------------------	---------	----

### 10-32 MALE TO 10-32 MALE



Cable Model No.

Standard Flexible Cable Assemblies

See website for the following cable(s)

50 Ohm, RG174A/U Coax	PE36520	21
50 Ohm, RG178B/U Coax	PE36522	22
50 Ohm, RG316/U Coax	PE36524	23

### 10-32 MALE TO 10-32 MALE RIGHT ANGLE



Cable Model No.

Standard Flexible Cable Assemblies

See website for the following cable(s)

50 Ohm, RG174A/U Coax	PE36526	24
-----------------------	---------	----

### 10-32 MALE TO BNC MALE



Cable Dia.	Atten.*	Max Power*	Length	Model No.	1-24	25-49	50-99
------------	---------	------------	--------	-----------	------	-------	-------

Standard Flexible Cable Assemblies

50 Ohm, RG174A/U Coax

0.100" dia.	31 dB / 100 ft.	16 W	12"	PE36538-12	\$41.95	\$39.01	\$36.08
			24"	PE36538-24	\$42.25	\$39.29	\$36.34
			36"	PE36538-36	\$42.55	\$39.57	\$36.59
			48"	PE36538-48	\$42.80	\$39.80	\$36.81
			60"	PE36538-60	\$43.05	\$40.04	\$37.02
			Any	PE36538-XX	See Website for Pricing		

See website for the following cable(s)

50 Ohm, RG178B/U Coax	PE36540	26
50 Ohm, RG316/U Coax	PE36542	27

Cable Assemblies

\*Coax Performance at 1 GHz  
Notes: Cable assembly max frequency may be lower than connector or coax max frequency



Free Freight Available  
via UPS Ground  
to USA & Canada



Real-Time Stock  
Levels & Pricing  
On Our WebSite



Toll-Free Technical  
Support  
(866) 727-8376



Same-Day Shipping,  
Even Custom  
Cable Assemblies

Cable Assemblies

\*Coax Performance at 1 GHz  
Notes: Cable assembly max frequency may be lower than connector or coax max frequency

### SC MALE TO SC MALE



Cable	Model No.
Standard Flexible Cable Assemblies	
<b>See website for the following cable(s)</b>	
50 Ohm, RG217/U Coax	PE34445
50 Ohm, RG225/U Coax	PE34447
50 Ohm, RG393/U Coax	PE3416

### LC MALE TO LC MALE



Cable	Model No.
Standard Flexible Cable Assemblies	
<b>See website for the following cable(s)</b>	
50 Ohm, RG217/U Coax	PE33537
50 Ohm, RG218/U Coax	PE3960
50 Ohm, RG393/U Coax	PE33539

### HN MALE TO HN MALE



Cable Dia.	Atten.*	Max Power*	Length	Model No.	1-24	25-49	50-99
Standard Flexible Cable Assemblies							
<b>See website for the following cable(s)</b>							
52 Ohm, RG8A/U Coax				PE33304			
50 Ohm, RG58C/U Coax				PE3852			
50 Ohm, RG142B/U Coax				PE3083			
50 Ohm, RG213/U Coax				PE3038			
<b>50 Ohm, RG214/U Coax</b>							
0.425" dia.	9 dB / 100 ft.	190 W	12"	PE3095-12	\$87.40	\$81.28	\$75.16
			24"	PE3095-24	\$93.15	\$86.63	\$80.11
			36"	PE3095-36	\$98.90	\$91.98	\$85.05
			48"	PE3095-48	\$104.65	\$97.32	\$90.00
			60"	PE3095-60	\$110.40	\$102.67	\$94.94
Any	PE3095-XX	See Website for Pricing					
<b>50 Ohm, RG217/U Coax</b>							
0.545" dia.	5.8 dB / 100 ft.	260 W	12"	PE33370-12	\$109.30	\$101.65	\$94.00
			24"	PE33370-24	\$111.75	\$103.93	\$96.11
			36"	PE33370-36	\$114.10	\$106.11	\$98.13
			48"	PE33370-48	\$116.70	\$108.53	\$100.36
			60"	PE33370-60	\$119.10	\$110.76	\$102.43
Any	PE33370-XX	See Website for Pricing					
<b>See website for the following cable(s)</b>							
50 Ohm, RG223/U Coax				PE3357			
<b>50 Ohm, RG393/U Coax</b>							
0.390" dia.	7.5 dB / 100 ft.	1700 W	12"	PE3340-12	\$94.10	\$87.51	\$80.93
			24"	PE3340-24	\$106.15	\$98.72	\$91.29
			36"	PE3340-36	\$118.15	\$109.88	\$101.61
			48"	PE3340-48	\$130.15	\$121.04	\$111.93
			60"	PE3340-60	\$142.20	\$132.25	\$122.29
Any	PE3340-XX	See Website for Pricing					
<b>See website for the following cable(s)</b>							
50 Ohm, RG400/U Coax				PE33938			
75 Ohm, RG59B/U Coax				PE34436			

### QMA MALE TO QMA MALE



Cable Dia.	Atten.*	Max Power*	Length	Model No.	1-24	25-49	50-99
Standard Flexible Cable Assemblies							
<b>See website for the following cable(s)</b>							
50 Ohm, RG58C/U Coax				PE38271			
50 Ohm, RG316/U Coax				PE38270			
<b>50 Ohm, RG316-DS Coax</b>							
0.114" dia.	30 dB / 100 ft.	160 W	12"	PE38161-12	\$45.50	\$42.32	\$39.13
			24"	PE38161-24	\$47.75	\$44.41	\$41.07
			36"	PE38161-36	\$50.05	\$46.55	\$43.04
			48"	PE38161-48	\$52.30	\$48.64	\$44.98
			60"	PE38161-60	\$54.60	\$50.78	\$46.96
Any	PE38161-XX	See Website for Pricing					
<b>See website for the following cable(s)</b>							
50 Ohm, PE-C195 Coax				PE38272			

### QN MALE TO QN MALE



Cable	Model No.
Standard Flexible Cable Assemblies	
<b>See website for the following cable(s)</b>	
50 Ohm, RG58C/U Coax	PE38448
50 Ohm, RG223/U Coax	PE38447

### SMP FEMALE TO SMP FEMALE



Cable Dia.	Atten.*	Max Power*	Length	Model No.	1-24	25-49	50-99
Standard Formable Cable Assemblies							
<b>50 Ohm, PE-SR047FL Coax</b>							
0.047" dia.	40 dB / 100 ft.	32 W	12"	PE36148-12	\$68.20	\$63.43	\$58.65
			24"	PE36148-24	\$73.85	\$68.68	\$63.51
			36"	PE36148-36	\$79.50	\$73.94	\$68.37
			48"	PE36148-48	\$85.20	\$79.24	\$73.27
			60"	PE36148-60	\$90.85	\$84.49	\$78.13
Any	PE36148-XX	See Website for Pricing					
<b>50 Ohm, PE-SR405FL Coax</b>							
0.085" dia.	22 dB / 100 ft.	130 W	12"	PE36152-12	\$81.30	\$75.61	\$69.92
			24"	PE36152-24	\$89.50	\$83.24	\$76.97
			36"	PE36152-36	\$97.75	\$90.91	\$84.07
			48"	PE36152-48	\$105.95	\$98.53	\$91.12
			60"	PE36152-60	\$114.20	\$106.21	\$98.21
Any	PE36152-XX	See Website for Pricing					
Standard Semirigid Cable Assemblies							
<b>See website for the following cable(s)</b>							
50 Ohm, PE-047SR Coax				PE36146			
50 Ohm, RG405/U Coax				PE36150			

### SMP FEMALE TO SMP FEMALE RIGHT ANGLE

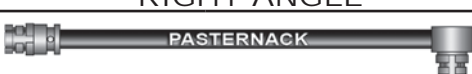

Cable	Model No.
Standard Formable Cable Assemblies	
<b>See website for the following cable(s)</b>	
50 Ohm, PE-SR047FL Coax	PE36156
50 Ohm, PE-SR405FL Coax	PE36160

Continued on Next Page

Continued from Previous Page

### SMP FEMALE TO SMP FEMALE RIGHT ANGLE



Cable Model No.

Standard Semirigid Cable Assemblies

See website for the following cable(s)		
50 Ohm, PE-047SR Coax	PE36154	1
50 Ohm, RG405/U Coax	PE36158	2

### UMCX PLUG TO UMCX PLUG



Cable Dia. Atten.\* Max Power\* Length Model No. 1-24 25-49 50-99

Standard Flexible Cable Assemblies

50 Ohm, 1.13mm Coax							
0.750" dia.	45 dB / 100 ft.	78 W	3"	PE38295-3	\$5.37	\$4.99	\$4.62
			6"	PE38295-6	\$5.93	\$5.51	\$5.10
			12"	PE38295-12	\$6.49	\$6.04	\$5.58
			Any	PE38295-XX	See Website for Pricing		

### UMCX PLUG RIGHT ANGLE TO MCX JACK BULKHEAD

SEE MOUNTING HOLE SECTION ON PAGE 246



Cable Model No.

Standard Flexible Cable Assemblies

See website for the following cable(s)	
50 Ohm, RG178B/U Coax	PE38889

### UMCX PLUG RIGHT ANGLE TO REVERSE POLARITY MCX JACK BULKHEAD

SEE MOUNTING HOLE SECTION ON PAGE 246



Cable Model No.

Standard Flexible Cable Assemblies

See website for the following cable(s)	
50 Ohm, RG178B/U Coax	PE38302

### UMCX PLUG TO 75 OHM MCX PLUG



Cable Model No.

Standard Flexible Cable Assemblies

See website for the following cable(s)		
50 Ohm, 1.13mm Coax	PE38298	4

### UMCX PLUG RIGHT ANGLE TO SSMB PLUG



Cable Model No.

Standard Flexible Cable Assemblies

See website for the following cable(s)	
50 Ohm, RG178B/U Coax	PE38930

### UMCX PLUG RIGHT ANGLE TO MMCX PLUG RIGHT ANGLE



Cable Model No.

Standard Flexible Cable Assemblies

See website for the following cable(s)		
50 Ohm, RG178B/U Coax	PE39078	5

### UMCX PLUG RIGHT ANGLE TO OPEN



Cable Dia. Atten.\* Max Power\* Length Model No. 1-24 25-49 50-99

Standard Flexible Cable Assemblies

50 Ohm, RG178B/U Coax							
0.750" dia.	45.0 dB / 100 ft.	78 W	3"	PE38296-3	\$35.05	\$32.60	\$30.14
			6"	PE38296-6	\$19.56	\$18.19	\$16.82
			9"	PE38296-9	\$35.05	\$32.60	\$30.14
			12"	PE38296-12	\$21.79	\$20.26	\$18.74
			18"	PE38296-18	\$25.35	\$23.58	\$21.80
			24"	PE38296-24	\$26.24	\$24.40	\$22.57
Any	PE38296-XX	See Website for Pricing					

### UMCX PLUG RIGHT ANGLE TO MCX PLUG



Cable Model No.

Standard Flexible Cable Assemblies

See website for the following cable(s)		
50 Ohm, RG178B/U Coax	PE38890	6

### UMCX PLUG RIGHT ANGLE TO MCX PLUG RIGHT ANGLE



Cable Model No.

Standard Flexible Cable Assemblies

See website for the following cable(s)		
50 Ohm, RG178B/U Coax	PE38502	7

### MMCX PLUG TO MMCX PLUG



Cable Dia. Atten.\* Max Power\* Length Model No. 1-24 25-49 50-99

Standard Flexible Cable Assemblies

50 Ohm, RG174A/U Coax							
0.100" dia.	31 dB / 100 ft.	16 W	12"	PE34879-12	\$38.00	\$35.34	\$32.68
			24"	PE34879-24	\$38.40	\$35.71	\$33.02
			36"	PE34879-36	\$38.85	\$36.13	\$33.41
			48"	PE34879-48	\$39.25	\$36.50	\$33.76
			60"	PE34879-60	\$39.70	\$36.92	\$34.14
			Any	PE34879-XX	See Website for Pricing		

Cable Assemblies

\*Coax Performance at 1 GHz  
Notes: Cable assembly max frequency may be lower than connector or coax max frequency

Continued on Next Page



Free Freight Available  
via UPS Ground  
to USA & Canada



Real-Time Stock  
Levels & Pricing  
On Our WebSite



Toil-Free Technical  
Support  
(866) 727-8376



Same-Day Shipping,  
Even Custom  
Cable Assemblies



Continued from Previous Page

### MMCX PLUG TO MMCX PLUG



Cable Dia.	Atten.*	Max Power*	Length	Model No.	1-24	25-49	50-99
<b>50 Ohm, RG178B/U Coax</b>							
0.750" dia.	45 dB / 100 ft.	78 W	12"	PE34598-12	\$37.65	\$35.01	\$32.38
			24"	PE34598-24	\$38.40	\$35.71	\$33.02
			36"	PE34598-36	\$39.15	\$36.41	\$33.67
			48"	PE34598-48	\$39.85	\$37.06	\$34.27
			60"	PE34598-60	\$40.60	\$37.76	\$34.92
Any	PE34598-XX	See Website for Pricing					
<b>See website for the following cable(s)</b>							
50 Ohm, RG188A/U Coax				PE34885			
50 Ohm, RG196A/U Coax				PE34891			
<b>50 Ohm, RG316/U Coax</b>							
0.102" dia.	30 dB / 100 ft.	160 W	12"	PE34240-12	\$38.85	\$36.13	\$33.41
			24"	PE34240-24	\$40.35	\$37.53	\$34.70
			36"	PE34240-36	\$41.70	\$38.78	\$35.86
			48"	PE34240-48	\$43.05	\$40.04	\$37.02
			60"	PE34240-60	\$44.55	\$41.43	\$38.31
Any	PE34240-XX	See Website for Pricing					

### MMCX PLUG TO MMCX PLUG RIGHT ANGLE



Cable Dia.	Atten.*	Max Power*	Length	Model No.	1-24	25-49	50-99
<b>Standard Flexible Cable Assemblies</b>							
<b>50 Ohm, RG174A/U Coax</b>							
0.100" dia.	31 dB / 100 ft.	16 W	12"	PE34881-12	\$45.40	\$42.22	\$39.04
			24"	PE34881-24	\$45.85	\$42.64	\$39.43
			36"	PE34881-36	\$46.30	\$43.06	\$39.82
			48"	PE34881-48	\$46.70	\$43.43	\$40.16
			60"	PE34881-60	\$47.15	\$43.85	\$40.55
Any	PE34881-XX	See Website for Pricing					
<b>See website for the following cable(s)</b>							
50 Ohm, RG178B/U Coax				PE34883			
50 Ohm, RG188A/U Coax				PE34889			
50 Ohm, RG316/U Coax				PE34895			
<b>Standard Formable Cable Assemblies</b>							
<b>See website for the following cable(s)</b>							
50 Ohm, PE-SR047FL Coax				PE38322			

### MMCX PLUG RIGHT ANGLE TO BNC FEMALE BULKHEAD

SEE MOUNTING HOLE SECTION ON PAGE 246



Cable Dia.	Atten.*	Max Power*	Length	Model No.	1-24	25-49	50-99
<b>Standard Flexible Cable Assemblies</b>							
<b>50 Ohm, RG174A/U Coax</b>							
0.100" dia.	31 dB / 100 ft.	16 W	12"	PE36738-12	\$45.20	\$42.04	\$38.87
			24"	PE36738-24	\$45.65	\$42.45	\$39.26
			36"	PE36738-36	\$46.10	\$42.87	\$39.65
			48"	PE36738-48	\$46.50	\$43.25	\$39.99
			60"	PE36738-60	\$46.95	\$43.66	\$40.38
Any	PE36738-XX	See Website for Pricing					

### MCX PLUG TO MCX PLUG



Cable Dia.	Atten.*	Max Power*	Length	Model No.	1-24	25-49	50-99
<b>Standard Flexible Cable Assemblies</b>							
<b>50 Ohm, RG174A/U Coax</b>							
0.100" dia.	31 dB / 100 ft.	16 W	12"	PE3295-12	\$33.10	\$30.78	\$28.47
			24"	PE3295-24	\$33.55	\$31.20	\$28.85
			36"	PE3295-36	\$34.00	\$31.62	\$29.24
			48"	PE3295-48	\$34.40	\$31.99	\$29.58
			60"	PE3295-60	\$34.85	\$32.41	\$29.97
Any	PE3295-XX	See Website for Pricing					
<b>See website for the following cable(s)</b>							
50 Ohm, RG188A/U Coax				PE3290			
<b>50 Ohm, RG316/U Coax</b>							
0.102" dia.	30 dB / 100 ft.	160 W	12"	PE3297-12	\$35.10	\$32.64	\$30.19
			24"	PE3297-24	\$37.45	\$34.83	\$32.21
			36"	PE3297-36	\$39.75	\$36.97	\$34.19
			48"	PE3297-48	\$41.25	\$38.36	\$35.48
			60"	PE3297-60	\$42.55	\$39.57	\$36.59
Any	PE3297-XX	See Website for Pricing					
<b>50 Ohm, RG316-DS Coax</b>							
0.114" dia.	30 dB / 100 ft.	160 W	12"	PE36799-12	\$34.95	\$32.50	\$30.06
			24"	PE36799-24	\$37.25	\$34.64	\$32.04
			36"	PE36799-36	\$39.50	\$36.74	\$33.97
			48"	PE36799-48	\$41.75	\$38.83	\$35.91
			60"	PE36799-60	\$44.05	\$40.97	\$37.88
Any	PE36799-XX	See Website for Pricing					

### MCX PLUG TO MCX PLUG RIGHT ANGLE



Cable	Model No.
<b>Standard Flexible Cable Assemblies</b>	
<b>See website for the following cable(s)</b>	
50 Ohm, RG174A/U Coax	PE3314
50 Ohm, RG188A/U Coax	PE3309
50 Ohm, RG196A/U Coax	PE3311
50 Ohm, RG316/U Coax	PE3316

### MCX PLUG RIGHT ANGLE TO MCX PLUG RIGHT ANGLE



Cable Dia.	Atten.*	Max Power*	Length	Model No.	1-24	25-49	50-99
<b>Standard Flexible Cable Assemblies</b>							
<b>50 Ohm, RG174A/U Coax</b>							
0.100" dia.	31 dB / 100 ft.	16 W	12"	PE3304-12	\$38.00	\$35.34	\$32.68
			24"	PE3304-24	\$38.40	\$35.71	\$33.02
			36"	PE3304-36	\$38.85	\$36.13	\$33.41
			48"	PE3304-48	\$39.25	\$36.50	\$33.76
			60"	PE3304-60	\$39.70	\$36.92	\$34.14
Any	PE3304-XX	See Website for Pricing					
<b>50 Ohm, RG188A/U Coax</b>							
0.110" dia.	30 dB / 100 ft.	160 W	12"	PE3299-12	\$39.25	\$36.50	\$33.76
			24"	PE3299-24	\$40.90	\$38.04	\$35.17
			36"	PE3299-36	\$42.60	\$39.62	\$36.64
			48"	PE3299-48	\$44.30	\$41.20	\$38.10
			60"	PE3299-60	\$46.00	\$42.78	\$39.56
Any	PE3299-XX	See Website for Pricing					

Cable Assemblies

\*Coax Performance at 1 GHz  
Notes: Cable assembly max frequency may be lower than connector or coax max frequency

Continued on Next Page

ROHS & REACH COMPLIANT. CUSTOM-LENGTH CABLE ASSEMBLIES MAY BE ORDERED ON OUR WEBSITE.

Continued from Previous Page

### MCX PLUG RIGHT ANGLE TO MCX PLUG RIGHT ANGLE



Cable Dia.	Atten.*	Max Power*	Length	Model No.	1-24	25-49	50-99
<b>See website for the following cable(s)</b>							
50 Ohm, RG196A/U Coax				PE3301			1
50 Ohm, RG316/U Coax				PE3306			2
50 Ohm, RG316-DS Coax				PE37099			3

### SMB PLUG TO SMB PLUG



Cable Dia.	Atten.*	Max Power*	Length	Model No.	1-24	25-49	50-99
<b>Standard Flexible Cable Assemblies</b>							
<b>50 Ohm, RG58C/U Coax</b>							
0.195" dia.	20 dB / 100 ft.	44 W	12"	PE33650-12	\$40.90	\$38.04	\$35.17
			24"	PE33650-24	\$41.45	\$38.55	\$35.65
			36"	PE33650-36	\$42.00	\$39.06	\$36.12
			48"	PE33650-48	\$42.55	\$39.57	\$36.59
			60"	PE33650-60	\$43.10	\$40.08	\$37.07
			Any	PE33650-XX	See Website for Pricing		
<b>See website for the following cable(s)</b>							
50 Ohm, RG142B/U Coax				PE33652			5
<b>50 Ohm, RG174A/U Coax</b>							
0.100" dia.	31 dB / 100 ft.	16 W	12"	PE3853-12	\$31.90	\$29.67	\$27.43
			24"	PE3853-24	\$32.30	\$30.04	\$27.78
			36"	PE3853-36	\$32.75	\$30.46	\$28.17
			48"	PE3853-48	\$33.20	\$30.88	\$28.55
			60"	PE3853-60	\$33.60	\$31.25	\$28.90
			Any	PE3853-XX	See Website for Pricing		
<b>50 Ohm, RG178B/U Coax</b>							
0.750" dia.	45 dB / 100 ft.	78 W	12"	PE33165-12	\$39.15	\$36.41	\$33.67
			24"	PE33165-24	\$39.85	\$37.06	\$34.27
			36"	PE33165-36	\$40.60	\$37.76	\$34.92
			48"	PE33165-48	\$41.35	\$38.46	\$35.56
			60"	PE33165-60	\$42.05	\$39.11	\$36.16
			Any	PE33165-XX	See Website for Pricing		
<b>50 Ohm, RG188A/U Coax</b>							
0.110" dia.	30 dB / 100 ft.	160 W	12"	PE3587-12	\$33.15	\$30.83	\$28.51
			24"	PE3587-24	\$34.85	\$32.41	\$29.97
			36"	PE3587-36	\$36.55	\$33.99	\$31.43
			48"	PE3587-48	\$38.25	\$35.57	\$32.90
			60"	PE3587-60	\$39.90	\$37.11	\$34.31
			Any	PE3587-XX	See Website for Pricing		
<b>See website for the following cable(s)</b>							
50 Ohm, RG188-DS Coax				PE3721			9
50 Ohm, RG196A/U Coax				PE3588			10
50 Ohm, RG223/U Coax				PE3166			11
<b>50 Ohm, RG316/U Coax</b>							
0.102" dia.	30 dB / 100 ft.	160 W	12"	PE3915-12	\$33.85	\$31.48	\$29.11
			24"	PE3915-24	\$36.25	\$33.71	\$31.18
			36"	PE3915-36	\$38.65	\$35.94	\$33.24
			48"	PE3915-48	\$41.00	\$38.13	\$35.26
			60"	PE3915-60	\$43.40	\$40.36	\$37.32
			Any	PE3915-XX	See Website for Pricing		
<b>50 Ohm, RG316-DS Coax</b>							
0.114" dia.	30 dB / 100 ft.	160 W	12"	PE33704-12	\$33.75	\$31.39	\$29.03
			24"	PE33704-24	\$36.00	\$33.48	\$30.96
			36"	PE33704-36	\$38.25	\$35.57	\$32.90
			48"	PE33704-48	\$40.55	\$37.71	\$34.87
			60"	PE33704-60	\$42.80	\$39.80	\$36.81
			Any	PE33704-XX	See Website for Pricing		

### SMB PLUG TO SMB PLUG



Cable Dia.	Atten.*	Max Power*	Length	Model No.	1-24	25-49	50-99
<b>See website for the following cable(s)</b>							
50 Ohm, RG400/U Coax				PE34269			14

### SMB PLUG TO SMB PLUG RIGHT ANGLE



Cable Dia.	Atten.*	Max Power*	Length	Model No.	1-24	25-49	50-99
<b>Standard Flexible Cable Assemblies</b>							
<b>See website for the following cable(s)</b>							
50 Ohm, RG58C/U Coax				PE33666			15
<b>50 Ohm, RG174A/U Coax</b>							
0.100" dia.	31 dB / 100 ft.	16 W	12"	PE33175-12	\$39.45	\$36.69	\$33.93
			24"	PE33175-24	\$39.85	\$37.06	\$34.27
			36"	PE33175-36	\$40.30	\$37.48	\$34.66
			48"	PE33175-48	\$40.75	\$37.90	\$35.05
			60"	PE33175-60	\$41.15	\$38.27	\$35.39
			Any	PE33175-XX	See Website for Pricing		
<b>50 Ohm, RG188A/U Coax</b>							
0.110" dia.	30 dB / 100 ft.	160 W	12"	PE3592-12	\$40.70	\$37.85	\$35.00
			24"	PE3592-24	\$42.40	\$39.43	\$36.46
			36"	PE3592-36	\$44.10	\$41.01	\$37.93
			48"	PE3592-48	\$45.75	\$42.55	\$39.35
			60"	PE3592-60	\$47.45	\$44.13	\$40.81
			Any	PE3592-XX	See Website for Pricing		
<b>See website for the following cable(s)</b>							
50 Ohm, RG188-DS Coax				PE33143			18
50 Ohm, RG223/U Coax				PE33670			19
50 Ohm, RG316/U Coax				PE33672			20
<b>50 Ohm, RG316-DS Coax</b>							
0.114" dia.	30 dB / 100 ft.	160 W	12"	PE34485-12	\$41.30	\$38.41	\$35.52
			24"	PE34485-24	\$43.55	\$40.50	\$37.45
			36"	PE34485-36	\$45.80	\$42.59	\$39.39
			48"	PE34485-48	\$48.10	\$44.73	\$41.37
			60"	PE34485-60	\$50.35	\$46.83	\$43.30
			Any	PE34485-XX	See Website for Pricing		

### SMB PLUG TO SMB JACK BULKHEAD

SEE MOUNTING HOLE SECTION ON PAGE 246



Cable Dia.	Atten.*	Max Power*	Length	Model No.	1-24	25-49	50-99
<b>Standard Flexible Cable Assemblies</b>							
<b>See website for the following cable(s)</b>							
<b>50 Ohm, RG58C/U Coax</b>							
0.195" dia.	20 dB / 100 ft.	44 W	12"	PE34493-12	\$49.30	\$45.85	\$42.40
			24"	PE34493-24	\$49.85	\$46.36	\$42.87
			36"	PE34493-36	\$50.40	\$46.87	\$43.34
			48"	PE34493-48	\$50.90	\$47.34	\$43.77
			60"	PE34493-60	\$51.45	\$47.85	\$44.25
			Any	PE34493-XX	See Website for Pricing		
<b>See website for the following cable(s)</b>							
50 Ohm, RG142B/U Coax				PE34495			23

Cable Assemblies

\*Coax Performance at 1 GHz  
Notes: Cable assembly max frequency may be lower than connector or coax max frequency

Continued on Next Page

Continued from Previous Page

### SMB PLUG TO SMB JACK BULKHEAD

SEE MOUNTING HOLE SECTION ON PAGE 246



Cable Dia.	Atten.*	Max Power*	Length	Model No.	1-24	25-49	50-99
<b>50 Ohm, RG174A/U Coax</b>							
0.100" dia.	31 dB / 100 ft.	16 W	12"	PE33674-12	\$36.85	\$34.27	\$31.69
			24"	PE33674-24	\$37.20	\$34.60	\$31.99
			36"	PE33674-36	\$37.45	\$34.83	\$32.21
			48"	PE33674-48	\$37.70	\$35.06	\$32.42
			60"	PE33674-60	\$37.90	\$35.25	\$32.59
		Any	PE33674-XX	See Website for Pricing			

See website for the following cable(s)

50 Ohm, RG178B/U Coax	PE33676
50 Ohm, RG188A/U Coax	PE3591
50 Ohm, RG188-DS Coax	PE34489
50 Ohm, RG196A/U Coax	PE3130
50 Ohm, RG316/U Coax	PE33680

**50 Ohm, RG316-DS Coax**

Cable Dia.	Atten.*	Max Power*	Length	Model No.	1-24	25-49	50-99
0.114" dia.	30 dB / 100 ft.	160 W	12"	PE34487-12	\$36.85	\$34.27	\$31.69
			24"	PE34487-24	\$39.35	\$36.60	\$33.84
			36"	PE34487-36	\$41.80	\$38.87	\$35.95
			48"	PE34487-48	\$44.35	\$41.25	\$38.14
			60"	PE34487-60	\$46.75	\$43.48	\$40.21
		Any	PE34487-XX	See Website for Pricing			

### SMB PLUG RIGHT ANGLE TO SMB PLUG RIGHT ANGLE



Cable Dia.	Atten.*	Max Power*	Length	Model No.	1-24	25-49	50-99
<b>Standard Flexible Cable Assemblies</b>							
<b>See website for the following cable(s)</b>							
50 Ohm, PE-B100 Coax	PE34465						
50 Ohm, RG58C/U Coax	PE33654						
50 Ohm, RG142B/U Coax	PE33656						

**50 Ohm, RG174A/U Coax**

Cable Dia.	Atten.*	Max Power*	Length	Model No.	1-24	25-49	50-99
0.100" dia.	31 dB / 100 ft.	16 W	12"	PE3916-12	\$42.60	\$39.62	\$36.64
			24"	PE3916-24	\$43.00	\$39.99	\$36.98
			36"	PE3916-36	\$43.45	\$40.41	\$37.37
			48"	PE3916-48	\$43.85	\$40.78	\$37.71
			60"	PE3916-60	\$44.30	\$41.20	\$38.10
		Any	PE3916-XX	See Website for Pricing			

**50 Ohm, RG178B/U Coax**

Cable Dia.	Atten.*	Max Power*	Length	Model No.	1-24	25-49	50-99
0.750" dia.	45 dB / 100 ft.	78 W	12"	PE33350-12	\$42.80	\$39.80	\$36.81
			24"	PE33350-24	\$43.50	\$40.46	\$37.41
			36"	PE33350-36	\$44.25	\$41.15	\$38.06
			48"	PE33350-48	\$44.95	\$41.80	\$38.66
			60"	PE33350-60	\$45.70	\$42.50	\$39.30
		Any	PE33350-XX	See Website for Pricing			

**50 Ohm, RG188A/U Coax**

Cable Dia.	Atten.*	Max Power*	Length	Model No.	1-24	25-49	50-99
0.110" dia.	30 dB / 100 ft.	160 W	12"	PE3589-12	\$43.85	\$40.78	\$37.71
			24"	PE3589-24	\$45.55	\$42.36	\$39.17
			36"	PE3589-36	\$47.20	\$43.90	\$40.59
			48"	PE3589-48	\$48.90	\$45.48	\$42.05
			60"	PE3589-60	\$50.60	\$47.06	\$43.52
		Any	PE3589-XX	See Website for Pricing			

See website for the following cable(s)

50 Ohm, RG188-DS Coax	PE34463
50 Ohm, RG196A/U Coax	PE3590
50 Ohm, RG223/U Coax	PE33121
50 Ohm, RG316/U Coax	PE3917

### SMB PLUG RIGHT ANGLE TO SMB PLUG RIGHT ANGLE



Cable Dia.	Atten.*	Max Power*	Length	Model No.	1-24	25-49	50-99
<b>50 Ohm, RG316-DS Coax</b>							
0.114" dia.	30 dB / 100 ft.	160 W	12"	PE33476-12	\$44.40	\$41.29	\$38.18
			24"	PE33476-24	\$46.70	\$43.43	\$40.16
			36"	PE33476-36	\$48.95	\$45.52	\$42.10
			48"	PE33476-48	\$51.25	\$47.66	\$44.08
			60"	PE33476-60	\$53.50	\$49.76	\$46.01
					Any	PE33476-XX	See Website for Pricing

### SMB PLUG RIGHT ANGLE TO SMB JACK BULKHEAD

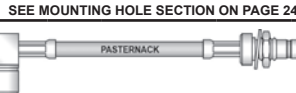

Cable Dia.	Atten.*	Max Power*	Length	Model No.	1-24	25-49	50-99
<b>Standard Flexible Cable Assemblies</b>							
<b>See website for the following cable(s)</b>							
50 Ohm, RG174A/U Coax	PE33261						
50 Ohm, RG178B/U Coax	PE34467						
<b>50 Ohm, RG188A/U Coax</b>							
0.110" dia.	30 dB / 100 ft.	160 W	12"	PE3594-12	\$43.30	\$40.27	\$37.24
			24"	PE3594-24	\$44.95	\$41.80	\$38.66
			36"	PE3594-36	\$46.65	\$43.38	\$40.12
			48"	PE3594-48	\$48.35	\$44.97	\$41.58
			60"	PE3594-60	\$50.05	\$46.55	\$43.04
		Any	PE3594-XX	See Website for Pricing			

**50 Ohm, RG316/U Coax**

Cable Dia.	Atten.*	Max Power*	Length	Model No.	1-24	25-49	50-99
0.102" dia.	30 dB / 100 ft.	160 W	12"	PE33675-12	\$44.00	\$40.92	\$37.84
			24"	PE33675-24	\$46.35	\$43.11	\$39.86
			36"	PE33675-36	\$48.75	\$45.34	\$41.93
			48"	PE33675-48	\$51.15	\$47.57	\$43.99
			60"	PE33675-60	\$53.55	\$49.80	\$46.05
		Any	PE33675-XX	See Website for Pricing			

### SMB PLUG TO BNC MALE



Cable Dia.	Atten.*	Max Power*	Length	Model No.	1-24	25-49	50-99
<b>Standard Flexible Cable Assemblies</b>							
<b>See website for the following cable(s)</b>							
50 Ohm, PE-B100 Coax	PE37536						
<b>50 Ohm, RG58C/U Coax</b>							
0.195" dia.	20 dB / 100 ft.	44 W	12"	PE3242-12	\$35.55	\$33.06	\$30.57
			24"	PE3242-24	\$35.90	\$33.39	\$30.87
			36"	PE3242-36	\$36.35	\$33.81	\$31.26
			48"	PE3242-48	\$36.75	\$34.18	\$31.61
			60"	PE3242-60	\$37.25	\$34.64	\$32.04
		Any	PE3242-XX	See Website for Pricing			

See website for the following cable(s)

50 Ohm, RG142B/U Coax	PE3349						
<b>50 Ohm, RG174A/U Coax</b>							
0.100" dia.	31 dB / 100 ft.	16 W	12"	PE3672-12	\$30.40	\$28.27	\$26.14
			24"	PE3672-24	\$30.80	\$28.64	\$26.49
			36"	PE3672-36	\$31.25	\$29.06	\$26.88
			48"	PE3672-48	\$31.65	\$29.43	\$27.22
			60"	PE3672-60	\$32.10	\$29.85	\$27.61
		Any	PE3672-XX	See Website for Pricing			

Cable Assemblies

\*Coax Performance at 1 GHz  
Notes: Cable assembly max frequency may be lower than connector or coax max frequency

Continued on Next Page

Continued from Previous Page

### SMB PLUG TO BNC MALE



Cable Dia.	Atten.*	Max Power*	Length	Model No.	1-24	25-49	50-99
<b>50 Ohm, RG188A/U Coax</b>							
0.110" dia.	30 dB / 100 ft.	160 W	12"	PE3671-12	\$31.65	\$29.43	\$27.22
			24"	PE3671-24	\$33.30	\$30.97	\$28.64
			36"	PE3671-36	\$35.00	\$32.55	\$30.10
			48"	PE3671-48	\$36.70	\$34.13	\$31.56
			60"	PE3671-60	\$38.40	\$35.71	\$33.02
			Any	PE3671-XX	See Website for Pricing		
<b>50 Ohm, RG223/U Coax</b>							
0.216" dia.	16.5 dB / 100 ft.	53 W	12"	PE3236-12	\$35.55	\$33.06	\$30.57
			24"	PE3236-24	\$36.85	\$34.27	\$31.69
			36"	PE3236-36	\$38.25	\$35.57	\$32.90
			48"	PE3236-48	\$39.55	\$36.78	\$34.01
			60"	PE3236-60	\$41.00	\$38.13	\$35.26
			Any	PE3236-XX	See Website for Pricing		
<b>50 Ohm, RG316/U Coax</b>							
0.102" dia.	30 dB / 100 ft.	160 W	12"	PE3746-12	\$32.35	\$30.09	\$27.82
			24"	PE3746-24	\$34.75	\$32.32	\$29.89
			36"	PE3746-36	\$37.10	\$34.50	\$31.91
			48"	PE3746-48	\$39.50	\$36.74	\$33.97
			60"	PE3746-60	\$41.90	\$38.97	\$36.03
			Any	PE3746-XX	See Website for Pricing		
<b>50 Ohm, RG316-DS Coax</b>							
0.114" dia.	30 dB / 100 ft.	160 W	12"	PE3530-12	\$42.35	\$39.39	\$36.42
			24"	PE3530-24	\$44.80	\$41.66	\$38.53
			36"	PE3530-36	\$47.25	\$43.94	\$40.64
			48"	PE3530-48	\$49.80	\$46.31	\$42.83
			60"	PE3530-60	\$52.25	\$48.59	\$44.94
			Any	PE3530-XX	See Website for Pricing		
<b>See website for the following cable(s)</b>							
50 Ohm, PE-P195 Coax				PE37250			

### SSMB PLUG RIGHT ANGLE TO SSMB PLUG RIGHT ANGLE



Cable	Model No.
Standard Flexible Cable Assemblies	
<b>See website for the following cable(s)</b>	
50 Ohm, RG196A/U Coax	PE3134
50 Ohm, RG316/U Coax	PE3157

### FAKRA PLUG TO FAKRA PLUG

SEE FAKRA SPECIFICATION ON PAGE 243



Cable	Model No.
Standard Flexible Cable Assemblies	
<b>See website for the following cable(s)</b>	
50 Ohm, RG174A/U Coax	PE38751A
	PE38751B
	PE38751C
	PE38751D
	PE38751H
	PE38751I
	PE38751K
	PE38751Z

### FAKRA PLUG TO FAKRA PLUG

SEE FAKRA SPECIFICATION ON PAGE 243



Cable	Model No.
50 Ohm, RG316/U Coax	PE38755A
	PE38755B
	PE38755C
	PE38755D
	PE38755H
	PE38755I
	PE38755K
50 Ohm, PE-C100 Coax	PE38755Z
	PE38747A
	PE38747B
	PE38747C
	PE38747D
	PE38747H
	PE38747I
PE38747K	
PE38747Z	

### FAKRA PLUG TO FAKRA JACK

SEE FAKRA SPECIFICATION ON PAGE 243



Cable	Model No.
Standard Flexible Cable Assemblies	
<b>See website for the following cable(s)</b>	
50 Ohm, RG174A/U Coax	PE38752A
	PE38752B
	PE38752C
	PE38752D
	PE38752H
	PE38752I
	PE38752K
50 Ohm, RG316/U Coax	PE38752Z
	PE38756A
	PE38756B
	PE38756C
	PE38756D
	PE38756H
	PE38756I
50 Ohm, PE-C100 Coax	PE38756K
	PE38756Z
	PE38748A
	PE38748B
	PE38748C
	PE38748D
	PE38748H
PE38748I	
PE38748K	
PE38748Z	

**FAKRA is  
a connector that complies with  
the German Automotive Standard  
(Fachkreis Automobil).**

Cable Assemblies

\*Coax Performance at 1 GHz  
Notes: Cable assembly max frequency may be lower than connector or coax max frequency



### FAKRA PLUG TO FAKRA JACK RIGHT ANGLE

SEE FAKRA SPECIFICATION ON PAGE 243



Cable	Model No.
Standard Flexible Cable Assemblies	
<b>See website for the following cable(s)</b>	
50 Ohm, RG174A/U Coax	PE38753A
	PE38753B
	PE38753C
	PE38753D
	PE38753H
	PE38753I
	PE38753K
50 Ohm, RG316/U Coax	PE38753Z
	PE38757A
	PE38757B
	PE38757C
	PE38757D
	PE38757H
	PE38757I
50 Ohm, PE-C100 Coax	PE38757K
	PE38757Z
	PE38749A
	PE38749B
	PE38749C
	PE38749D
	PE38749H
	PE38749I
	PE38749K
	PE38749Z

### FAKRA JACK TO FAKRA JACK

SEE FAKRA SPECIFICATION ON PAGE 243



Cable	Model No.
Standard Flexible Cable Assemblies	
<b>See website for the following cable(s)</b>	
50 Ohm, RG174A/U Coax	PE38750A
	PE38750B
	PE38750C
	PE38750D
	PE38750H
	PE38750I
	PE38750K
50 Ohm, RG316/U Coax	PE38750Z
	PE38754A
	PE38754B
	PE38754C
	PE38754D
	PE38754H
	PE38754I
50 Ohm, PE-C100 Coax	PE38754K
	PE38754Z
	PE38746A
	PE38746B
	PE38746C
	PE38746D
	PE38746H
PE38746I	
PE38746K	
PE38746Z	

### GR874 TO GR874



Cable	Model No.
Standard Flexible Cable Assemblies	
<b>See website for the following cable(s)</b>	
50 Ohm, RG58C/U Coax	PE3211
50 Ohm, RG214/U Coax	PE3158

### GR874 TO BNC MALE



Cable	Model No.
Standard Flexible Cable Assemblies	
<b>See website for the following cable(s)</b>	
50 Ohm, RG214/U Coax	PE3145
50 Ohm, RG223/U Coax	PE3182

### BNC MALE TO BNC MALE





Cable Dia.	Atten.*	Max Power* Length	Model No.	1-24	25-49	50-99	
Standard Flexible Cable Assemblies							
<b>See website for the following cable(s)</b>							
52 Ohm, RG8A/U Coax			PE3807				
50 Ohm, RG8X Coax			PE3264				
<b>53.5 Ohm, RG55B/U Coax</b>							
0.206" dia.	16.5 dB / 100 ft.	53 W	12"	PE3583-12	\$21.85	\$20.32	\$18.79
			24"	PE3583-24	\$22.60	\$21.02	\$19.44
			36"	PE3583-36	\$23.90	\$22.23	\$20.55
			48"	PE3583-48	\$25.60	\$23.81	\$22.02
			60"	PE3583-60	\$27.30	\$25.39	\$23.48
			Any	PE3583-XX	See Website for Pricing		
<b>50 Ohm, RG58C/U Coax</b>							
0.195" dia.	20 dB / 100 ft.	44 W	12"	PE3067-12	\$23.35	\$21.72	\$20.08
			24"	PE3067-24	\$23.90	\$22.23	\$20.55
			36"	PE3067-36	\$24.60	\$22.88	\$21.16
			48"	PE3067-48	\$25.20	\$23.44	\$21.67
			60"	PE3067-60	\$25.85	\$24.04	\$22.23
			Any	PE3067-XX	See Website for Pricing		
<b>See website for the following cable(s)</b>							
50 Ohm, RG58-P Coax			PE3999				
<b>93 Ohm, RG62A/U Coax</b>							
0.242" dia.	8.5 dB / 100 ft.	77 W	12"	PE3081-12	\$20.50	\$19.07	\$17.63
			24"	PE3081-24	\$21.30	\$19.81	\$18.32
			36"	PE3081-36	\$22.30	\$20.74	\$19.18
			48"	PE3081-48	\$23.35	\$21.72	\$20.08
			60"	PE3081-60	\$24.40	\$22.69	\$20.98
			Any	PE3081-XX	See Website for Pricing		
<b>50 Ohm, RG142B/U Coax</b>							
0.195" dia.	13 dB / 100 ft.	650 W	12"	PE3495-12	\$22.90	\$21.30	\$19.69
			24"	PE3495-24	\$27.05	\$25.16	\$23.26
			36"	PE3495-36	\$31.20	\$29.02	\$26.83
			48"	PE3495-48	\$35.30	\$32.83	\$30.36
			60"	PE3495-60	\$39.45	\$36.69	\$33.93
			Any	PE3495-XX	See Website for Pricing		

\*Coax Performance at 1 GHz  
Notes: Cable assembly max frequency may be lower than connector or coax max frequency

Continued on Next Page

Continued from Previous Page

BNC MALE TO BNC MALE							
							
Cable Dia.	Atten.*	Max Power*	Length	Model No.	1-24	25-49	50-99
<b>50 Ohm, RG174A/U Coax</b>							
0.100" dia.	31 dB / 100 ft.	16 W	12"	PE3538-12	\$28.85	\$26.83	\$24.81
			24"	PE3538-24	\$29.30	\$27.25	\$25.20
			36"	PE3538-36	\$29.70	\$27.62	\$25.54
			48"	PE3538-48	\$30.15	\$28.04	\$25.93
			60"	PE3538-60	\$30.55	\$28.41	\$26.27
			Any	PE3538-XX	See Website for Pricing		
<b>See website for the following cable(s)</b>							
50 Ohm, RG178B/U Coax				PE33130			
95 Ohm, RG180B/U Twinax				PE33574			
<b>50 Ohm, RG188A/U Coax</b>							
0.110" dia.	30 dB / 100 ft.	160 W	12"	PE3470-12	\$30.10	\$27.99	\$25.89
			24"	PE3470-24	\$31.80	\$29.57	\$27.35
			36"	PE3470-36	\$33.50	\$31.16	\$28.81
			48"	PE3470-48	\$35.20	\$32.74	\$30.27
			60"	PE3470-60	\$36.85	\$34.27	\$31.69
			Any	PE3470-XX	See Website for Pricing		
<b>See website for the following cable(s)</b>							
50 Ohm, RG188-DS Coax				PE34388			
<b>50 Ohm, RG213/U Coax</b>							
0.405" dia.	9 dB / 100 ft.	190 W	12"	PE3749-12	\$50.60	\$47.06	\$43.52
			24"	PE3749-24	\$51.90	\$48.27	\$44.63
			36"	PE3749-36	\$53.55	\$49.80	\$46.05
			48"	PE3749-48	\$55.05	\$51.20	\$47.34
			60"	PE3749-60	\$56.45	\$52.50	\$48.55
			Any	PE3749-XX	See Website for Pricing		
<b>50 Ohm, RG214/U Coax</b>							
0.425" dia.	9 dB / 100 ft.	190 W	12"	PE3906-12	\$55.80	\$51.89	\$47.99
			24"	PE3906-24	\$61.55	\$57.24	\$52.93
			36"	PE3906-36	\$67.05	\$62.36	\$57.66
			48"	PE3906-48	\$72.25	\$67.19	\$62.14
			60"	PE3906-60	\$77.65	\$72.21	\$66.78
			Any	PE3906-XX	See Website for Pricing		
<b>50 Ohm, RG223/U Coax</b>							
0.216" dia.	16.5 dB / 100 ft.	53 W	12"	PE3087-12	\$21.85	\$20.32	\$18.79
			24"	PE3087-24	\$23.20	\$21.58	\$19.95
			36"	PE3087-36	\$25.40	\$23.62	\$21.84
			48"	PE3087-48	\$27.60	\$25.67	\$23.74
			60"	PE3087-60	\$29.80	\$27.71	\$25.63
			Any	PE3087-XX	See Website for Pricing		
<b>50 Ohm, RG316/U Coax</b>							
0.102" dia.	30 dB / 100 ft.	160 W	12"	PE3584-12	\$30.80	\$28.64	\$26.49
			24"	PE3584-24	\$32.55	\$30.27	\$27.99
			36"	PE3584-36	\$33.85	\$31.48	\$29.11
			48"	PE3584-48	\$35.25	\$32.78	\$30.32
			60"	PE3584-60	\$36.85	\$34.27	\$31.69
			Any	PE3584-XX	See Website for Pricing		
<b>See website for the following cable(s)</b>							
50 Ohm, RG316-DS Coax				PE3163			
<b>50 Ohm, RG400/U Coax</b>							
0.195" dia.	13 dB / 100 ft.	650 W	12"	PE3582-12	\$28.60	\$26.60	\$24.60
			24"	PE3582-24	\$34.00	\$31.62	\$29.24
			36"	PE3582-36	\$38.85	\$36.13	\$33.41
			48"	PE3582-48	\$42.75	\$39.76	\$36.77
			60"	PE3582-60	\$46.65	\$43.38	\$40.12
			Any	PE3582-XX	See Website for Pricing		
<b>See website for the following cable(s)</b>							
50 Ohm, PE-C195 Coax				PE36066			
50 Ohm, PE-C240 Coax				PE36219			

BNC MALE TO BNC MALE							
							
Cable Dia.	Atten.*	Max Power*	Length	Model No.	1-24	25-49	50-99
<b>75 Ohm, RG59B/U Coax</b>							
0.242" dia.	11.5 dB / 100 ft.	77 W	12"	PE3075-12	\$19.95	\$18.55	\$17.16
			24"	PE3075-24	\$20.65	\$19.20	\$17.76
			36"	PE3075-36	\$21.40	\$19.90	\$18.40
			48"	PE3075-48	\$22.10	\$20.55	\$19.01
			60"	PE3075-60	\$22.85	\$21.25	\$19.65
			Any	PE3075-XX	See Website for Pricing		
<b>75 Ohm, RG179B/U Coax</b>							
0.100" dia.	25 dB / 100 ft.	200 W	12"	PE3705-12	\$30.30	\$28.18	\$26.06
			24"	PE3705-24	\$32.20	\$29.95	\$27.69
			36"	PE3705-36	\$33.85	\$31.48	\$29.11
			48"	PE3705-48	\$35.25	\$32.78	\$30.32
			60"	PE3705-60	\$36.85	\$34.27	\$31.69
			Any	PE3705-XX	See Website for Pricing		
<b>See website for the following cable(s)</b>							
75 Ohm, RG302/U Coax				PE33123			
50 Ohm, PE-P195 Coax				PE34035			
Standard Formable Cable Assemblies							
<b>See website for the following cable(s)</b>							
50 Ohm, PE-SR402FL Coax				PE3462			
Standard Semirigid Cable Assemblies							
<b>See website for the following cable(s)</b>							
50 Ohm, PE-SR402AL Coax				PE34164			
50 Ohm, RG402/U Coax				PE3445			
50 Ohm, RG405/U Coax				PE3678			

BNC MALE TO BNC MALE RIGHT ANGLE							
							
Cable Dia.	Atten.*	Max Power*	Length	Model No.	1-24	25-49	50-99
Standard Flexible Cable Assemblies							
<b>50 Ohm, RG58C/U Coax</b>							
0.195" dia.	20 dB / 100 ft.	44 W	12"	PE3020-12	\$36.95	\$34.36	\$31.78
			24"	PE3020-24	\$37.60	\$34.97	\$32.34
			36"	PE3020-36	\$38.15	\$35.48	\$32.81
			48"	PE3020-48	\$38.70	\$35.99	\$33.28
			60"	PE3020-60	\$39.45	\$36.69	\$33.93
			Any	PE3020-XX	See Website for Pricing		
<b>See website for the following cable(s)</b>							
50 Ohm, RG142B/U Coax				PE3082			
<b>50 Ohm, RG174A/U Coax</b>							
0.100" dia.	31 dB / 100 ft.	16 W	12"	PE3460-12	\$39.90	\$37.11	\$34.31
			24"	PE3460-24	\$40.35	\$37.53	\$34.70
			36"	PE3460-36	\$40.75	\$37.90	\$35.05
			48"	PE3460-48	\$41.20	\$38.32	\$35.43
			60"	PE3460-60	\$41.60	\$38.69	\$35.78
			Any	PE3460-XX	See Website for Pricing		
<b>See website for the following cable(s)</b>							
50 Ohm, RG188A/U Coax				PE3113			
50 Ohm, RG188-DS Coax				PE3330			
50 Ohm, RG213/U Coax				PE3355			
50 Ohm, RG214/U Coax				PE3325			
<b>50 Ohm, RG223/U Coax</b>							
0.216" dia.	16.5 dB / 100 ft.	53 W	12"	PE3689-12	\$32.75	\$30.46	\$28.17
			24"	PE3689-24	\$34.30	\$31.90	\$29.50
			36"	PE3689-36	\$36.55	\$33.99	\$31.43
			48"	PE3689-48	\$38.75	\$36.04	\$33.33
			60"	PE3689-60	\$40.95	\$38.08	\$35.22
			Any	PE3689-XX	See Website for Pricing		

Cable Assemblies

\*Coax Performance at 1 GHz  
Notes: Cable assembly max frequency may be lower than connector or coax max frequency

Continued on Next Page

Continued from Previous Page

### BNC MALE TO BNC MALE RIGHT ANGLE



Cable Dia.	Atten.*	Max Power*	Length	Model No.	1-24	25-49	50-99
<b>See website for the following cable(s)</b>							
50 Ohm, RG316/U Coax				PE3332			
50 Ohm, RG316-DS Coax				PE3358			
50 Ohm, RG400/U Coax				PE3116			
75 Ohm, RG59B/U Coax				PE3508			
75 Ohm, RG179B/U Coax				PE3054			
<b>Standard Formable Cable Assemblies</b>							
<b>See website for the following cable(s)</b>							
50 Ohm, PE-SR402FL Coax				PE35580			
<b>Standard Semirigid Cable Assemblies</b>							
<b>See website for the following cable(s)</b>							
50 Ohm, RG402/U Coax				PE39108			

### BNC MALE TO BNC FEMALE



Cable Dia.	Atten.*	Max Power*	Length	Model No.	1-24	25-49	50-99
<b>Standard Flexible Cable Assemblies</b>							
<b>See website for the following cable(s)</b>							
52 Ohm, RG8A/U Coax				PE3360			
53.5 Ohm, RG55B/U Coax				PE3375			
<b>50 Ohm, RG58C/U Coax</b>							
0.195" dia.	20 dB / 100 ft.	44 W	12"	PE3047-12	\$25.75	\$23.95	\$22.15
			24"	PE3047-24	\$26.30	\$24.46	\$22.62
			36"	PE3047-36	\$26.85	\$24.97	\$23.09
			48"	PE3047-48	\$27.40	\$25.48	\$23.56
			60"	PE3047-60	\$27.95	\$25.99	\$24.04
			Any	PE3047-XX	See Website for Pricing		
<b>See website for the following cable(s)</b>							
50 Ohm, RG142B/U Coax				PE3777			
<b>50 Ohm, RG174A/U Coax</b>							
0.100" dia.	31 dB / 100 ft.	16 W	12"	PE3674-12	\$32.35	\$30.09	\$27.82
			24"	PE3674-24	\$32.80	\$30.50	\$28.21
			36"	PE3674-36	\$33.20	\$30.88	\$28.55
			48"	PE3674-48	\$33.65	\$31.29	\$28.94
			60"	PE3674-60	\$34.05	\$31.67	\$29.28
			Any	PE3674-XX	See Website for Pricing		
<b>See website for the following cable(s)</b>							
50 Ohm, RG213/U Coax				PE3949			
50 Ohm, RG214/U Coax				PE3371			
50 Ohm, RG223/U Coax				PE3606			
50 Ohm, RG316/U Coax				PE3079			
50 Ohm, RG400/U Coax				PE3627			
50 Ohm, PE-C195 Coax				PE38344			
75 Ohm, RG59B/U Coax				PE3792			
75 Ohm, RG179B/U Coax				PE3354			

Radio frequencies and microwaves all travel at the Speed of Light which equals 300,000 kilometers per second or 186,000 miles per second or 173 astronomical units per day.

### BNC MALE TO BNC FEMALE BULKHEAD

SEE MOUNTING HOLE SECTION ON PAGE 246



Cable Dia.	Atten.*	Max Power*	Length	Model No.	1-24	25-49	50-99
<b>Standard Flexible Cable Assemblies</b>							
<b>50 Ohm, RG58C/U Coax</b>							
0.195" dia.	20 dB / 100 ft.	44 W	12"	PE3649-12	\$29.65	\$27.57	\$25.50
			24"	PE3649-24	\$30.20	\$28.09	\$25.97
			36"	PE3649-36	\$30.75	\$28.60	\$26.45
			48"	PE3649-48	\$31.25	\$29.06	\$26.88
			60"	PE3649-60	\$31.80	\$29.57	\$27.35
			Any	PE3649-XX	See Website for Pricing		
<b>See website for the following cable(s)</b>							
50 Ohm, RG142B/U Coax				PE3436			
<b>50 Ohm, RG174A/U Coax</b>							
0.100" dia.	31 dB / 100 ft.	16 W	12"	PE3431-12	\$35.55	\$33.06	\$30.57
			24"	PE3431-24	\$35.80	\$33.29	\$30.79
			36"	PE3431-36	\$36.05	\$33.53	\$31.00
			48"	PE3431-48	\$36.30	\$33.76	\$31.22
			60"	PE3431-60	\$36.60	\$34.04	\$31.48
			Any	PE3431-XX	See Website for Pricing		
<b>See website for the following cable(s)</b>							
50 Ohm, RG188A/U Coax				PE3442			
50 Ohm, RG188-DS Coax				PE3446			
<b>50 Ohm, RG223/U Coax</b>							
0.216" dia.	16.5 dB / 100 ft.	53 W	12"	PE3557-12	\$31.40	\$29.20	\$27.00
			24"	PE3557-24	\$32.75	\$30.46	\$28.17
			36"	PE3557-36	\$34.55	\$32.13	\$29.71
			48"	PE3557-48	\$36.75	\$34.18	\$31.61
			60"	PE3557-60	\$39.00	\$36.27	\$33.54
			Any	PE3557-XX	See Website for Pricing		
<b>50 Ohm, RG316/U Coax</b>							
0.102" dia.	30 dB / 100 ft.	160 W	12"	PE3854-12	\$35.55	\$33.06	\$30.57
			24"	PE3854-24	\$37.55	\$34.92	\$32.29
			36"	PE3854-36	\$39.95	\$37.15	\$34.36
			48"	PE3854-48	\$42.35	\$39.39	\$36.42
			60"	PE3854-60	\$44.75	\$41.62	\$38.49
			Any	PE3854-XX	See Website for Pricing		
<b>See website for the following cable(s)</b>							
50 Ohm, RG316-DS Coax				PE3454			
50 Ohm, RG400/U Coax				PE3423			
75 Ohm, RG59B/U Coax				PE3103			
75 Ohm, RG179B/U Coax				PE3413			

### BNC MALE RIGHT ANGLE TO BNC MALE RIGHT ANGLE



Cable Dia.	Atten.*	Max Power*	Length	Model No.	1-24	25-49	50-99
<b>Standard Flexible Cable Assemblies</b>							
<b>See website for the following cable(s)</b>							
53.5 Ohm, RG55B/U Coax				PE38506			
<b>50 Ohm, RG58C/U Coax</b>							
0.195" dia.	20 dB / 100 ft.	44 W	12"	PE3025-12	\$50.60	\$47.06	\$43.52
			24"	PE3025-24	\$51.15	\$47.57	\$43.99
			36"	PE3025-36	\$51.75	\$48.13	\$44.51
			48"	PE3025-48	\$52.45	\$48.78	\$45.11
			60"	PE3025-60	\$53.00	\$49.29	\$45.58
			Any	PE3025-XX	See Website for Pricing		

Cable Assemblies

\*Coax Performance at 1 GHz  
Notes: Cable assembly max frequency may be lower than connector or coax max frequency

Continued on Next Page

ROHS & REACH COMPLIANT. CUSTOM-LENGTH CABLE ASSEMBLIES MAY BE ORDERED ON OUR WEBSITE.

Continued from Previous Page

### BNC MALE RIGHT ANGLE TO BNC MALE RIGHT ANGLE



Cable Dia.	Atten.*	Max Power*	Length	Model No.	1-24	25-49	50-99
<b>50 Ohm, RG142B/U Coax</b>							
0.195" dia.	13 dB / 100 ft.	650 W	12"	PE3044-12	\$49.60	\$46.13	\$42.66
			24"	PE3044-24	\$53.75	\$49.99	\$46.23
			36"	PE3044-36	\$57.85	\$53.80	\$49.75
			48"	PE3044-48	\$62.00	\$57.66	\$53.32
			60"	PE3044-60	\$66.15	\$61.52	\$56.89
		Any	PE3044-XX	See Website for Pricing			
<b>50 Ohm, RG174A/U Coax</b>							
0.100" dia.	31 dB / 100 ft.	16 W	12"	PE3373-12	\$50.95	\$47.38	\$43.82
			24"	PE3373-24	\$51.35	\$47.76	\$44.16
			36"	PE3373-36	\$51.80	\$48.17	\$44.55
			48"	PE3373-48	\$52.25	\$48.59	\$44.94
			60"	PE3373-60	\$52.65	\$48.96	\$45.28
		Any	PE3373-XX	See Website for Pricing			
<b>See website for the following cable(s)</b>							
50 Ohm, RG188A/U Coax				PE3351			
50 Ohm, RG214/U Coax				PE3370			
50 Ohm, RG223/U Coax				PE3816			
50 Ohm, RG316/U Coax				PE3842			
<b>50 Ohm, RG316-DS Coax</b>							
0.114" dia.	30 dB / 100 ft.	160 W	12"	PE3389-12	\$52.80	\$49.10	\$45.41
			24"	PE3389-24	\$55.05	\$51.20	\$47.34
			36"	PE3389-36	\$57.30	\$53.29	\$49.28
			48"	PE3389-48	\$59.60	\$55.43	\$51.26
			60"	PE3389-60	\$61.85	\$57.52	\$53.19
		Any	PE3389-XX	See Website for Pricing			
<b>See website for the following cable(s)</b>							
50 Ohm, RG400/U Coax				PE3458			
<b>75 Ohm, RG59B/U Coax</b>							
0.242" dia.	11.5 dB / 100 ft.	77 W	12"	PE3935-12	\$50.45	\$46.92	\$43.39
			24"	PE3935-24	\$51.20	\$47.62	\$44.03
			36"	PE3935-36	\$51.90	\$48.27	\$44.63
			48"	PE3935-48	\$52.65	\$48.96	\$45.28
			60"	PE3935-60	\$53.40	\$49.66	\$45.92
		Any	PE3935-XX	See Website for Pricing			
<b>See website for the following cable(s)</b>							
75 Ohm, RG179B/U Coax				PE3366			
50 Ohm, PE-P195 Coax				PE37640			

### BNC FEMALE TO BNC FEMALE



Cable Dia.	Atten.*	Max Power*	Length	Model No.	1-24	25-49	50-99
<b>Standard Flexible Cable Assemblies</b>							
<b>50 Ohm, RG58C/U Coax</b>							
0.195" dia.	20 dB / 100 ft.	44 W	12"	PE3052-12	\$27.10	\$25.20	\$23.31
			24"	PE3052-24	\$27.65	\$25.71	\$23.78
			36"	PE3052-36	\$28.15	\$26.18	\$24.21
			48"	PE3052-48	\$28.70	\$26.69	\$24.68
			60"	PE3052-60	\$29.25	\$27.20	\$25.16
		Any	PE3052-XX	See Website for Pricing			
<b>50 Ohm, RG174A/U Coax</b>							
0.100" dia.	31 dB / 100 ft.	16 W	12"	PE3604-12	\$35.85	\$33.34	\$30.83
			24"	PE3604-24	\$36.30	\$33.76	\$31.22
			36"	PE3604-36	\$36.70	\$34.13	\$31.56
			48"	PE3604-48	\$37.15	\$34.55	\$31.95
			60"	PE3604-60	\$37.55	\$34.92	\$32.29
		Any	PE3604-XX	See Website for Pricing			

### BNC FEMALE TO BNC FEMALE



Cable Dia.	Atten.*	Max Power*	Length	Model No.	1-24	25-49	50-99
<b>See website for the following cable(s)</b>							
50 Ohm, RG223/U Coax				PE3364			
<b>50 Ohm, RG316/U Coax</b>							
0.102" dia.	30 dB / 100 ft.	160 W	12"	PE3505-12	\$37.80	\$35.15	\$32.51
			24"	PE3505-24	\$40.20	\$37.39	\$34.57
			36"	PE3505-36	\$42.60	\$39.62	\$36.64
			48"	PE3505-48	\$45.00	\$41.85	\$38.70
			60"	PE3505-60	\$47.40	\$44.08	\$40.76
		Any	PE3505-XX	See Website for Pricing			

### BNC MALE TO BANANA PLUG



Cable Dia.	Atten.*	Max Power*	Length	Model No.	1-24	25-49	50-99
<b>Standard Flexible Cable Assemblies</b>							
<b>See website for the following cable(s)</b>							
50 Ohm, RG58C/U Coax				PE3000			
<b>50 Ohm, RG58C/U Coax</b>							
0.195" dia.	20 dB / 100 ft.	44 W	12"	PE33552-12	\$32.70	\$30.41	\$28.12
			24"	PE33552-24	\$33.25	\$30.92	\$28.60
			36"	PE33552-36	\$33.75	\$31.39	\$29.03
			48"	PE33552-48	\$34.30	\$31.90	\$29.50
			60"	PE33552-60	\$34.85	\$32.41	\$29.97
		Any	PE33552-XX	See Website for Pricing			
<b>See website for the following cable(s)</b>							
50 Ohm, RG142B/U Coax				PE33440			
50 Ohm, RG174A/U Coax				PE34593			
50 Ohm, RG223/U Coax				PE33442			
50 Ohm, RG316/U Coax				PE34597			
75 Ohm, RG59B/U Coax				PE33554			

### BNC MALE TO ALLIGATOR CLIP



Cable Dia.	Atten.*	Max Power*	Length	Model No.	1-24	25-49	50-99
<b>Standard Flexible Cable Assemblies</b>							
<b>See website for the following cable(s)</b>							
53.5 Ohm, RG55B/U Coax				PE34536			
<b>50 Ohm, RG58C/U Coax</b>							
0.195" dia.	20 dB / 100 ft.	44 W	12"	PE3501-12	\$29.20	\$27.16	\$25.11
			24"	PE3501-24	\$29.70	\$27.62	\$25.54
			36"	PE3501-36	\$30.45	\$28.32	\$26.19
			48"	PE3501-48	\$31.00	\$28.83	\$26.66
			60"	PE3501-60	\$31.55	\$29.34	\$27.13
		Any	PE3501-XX	See Website for Pricing			
<b>See website for the following cable(s)</b>							
50 Ohm, RG223/U Coax				PE3346			
50 Ohm, RG400/U Coax				PE34534			

### BNC MALE TO MINI ALLIGATOR CLIP



Cable	Model No.
<b>Standard Flexible Cable Assemblies</b>	
<b>See website for the following cable(s)</b>	
50 Ohm, RG58C/U Coax	PE33546

Cable Assemblies

\*Coax Performance at 1 GHz  
Notes: Cable assembly max frequency may be lower than connector or coax max frequency



Free Freight Available  
via UPS Ground  
to USA & Canada



Real-Time Stock  
Levels & Pricing  
On Our Website



Toll-Free Technical  
Support  
(866) 727-8376



Same-Day Shipping,  
Even Custom  
Cable Assemblies



Cable Assemblies

\*Coax Performance at 1 GHz  
Notes: Cable assembly max frequency may be lower than connector or coax max frequency

### BNC MALE TO TIP PLUG



Cable Model No.

Standard Flexible Cable Assemblies

50 Ohm, RG58C/U Coax		
50 Ohm, RG58C/U Coax	PE33009	1

### BNC MALE TO MINI BANANA PLUG



Cable Model No.

Standard Flexible Cable Assemblies

See website for the following cable(s)		
50 Ohm, RG58C/U Coax	PE33557	2

### BNC MALE TO HOOK



Cable Dia.	Atten.*	Max Power*	Length	Model No.	1-24	25-49	50-99
Standard Flexible Cable Assemblies							
50 Ohm, RG58C/U Coax							
0.195" dia.	20 dB / 100 ft.	44 W	12"	PE33561-12	\$32.70	\$30.41	\$28.12
			24"	PE33561-24	\$33.25	\$30.92	\$28.60
			36"	PE33561-36	\$33.75	\$31.39	\$29.03
			48"	PE33561-48	\$34.30	\$31.90	\$29.50
			60"	PE33561-60	\$34.85	\$32.41	\$29.97
Any	PE33561-XX	See Website for Pricing					
See website for the following cable(s)							
75 Ohm, RG59B/U Coax	PE33563	4					

### BNC MALE TO UNTERMINATED LEAD



Cable Dia.	Atten.*	Max Power*	Length	Model No.	1-24	25-49	50-99
Standard Flexible Cable Assemblies							
50 Ohm, RG58C/U Coax							
0.195" dia.	20 dB / 100 ft.	44 W	12"	PE33565-12	\$27.90	\$25.95	\$23.99
			24"	PE33565-24	\$28.40	\$26.41	\$24.42
			36"	PE33565-36	\$28.95	\$26.92	\$24.90
			48"	PE33565-48	\$29.50	\$27.44	\$25.37
			60"	PE33565-60	\$30.05	\$27.95	\$25.84
Any	PE33565-XX	See Website for Pricing					
See website for the following cable(s)							
75 Ohm, RG59B/U Coax	PE33567	6					

### BNC MALE TO NMO MOUNT CONNECTOR

NMO MOUNT REQUIRES 3/4" HOLE, 1 1/8"-18 THREAD AND INSTALLS FROM ABOVE.



Cable Model No.

Standard Flexible Cable Assemblies

See website for the following cable(s)		
50 Ohm, RG58C/U Coax	PE37844	7

### BNC FEMALE TO NMO MOUNT CONNECTOR

NMO MOUNT REQUIRES 3/4" HOLE, 1 1/8"-18 THREAD AND INSTALLS FROM ABOVE.



Cable Model No.

Standard Flexible Cable Assemblies

See website for the following cable(s)		
50 Ohm, RG58C/U Coax	PE37845	8

### MHV MALE TO MHV MALE



Cable Dia.	Atten.*	Max Power*	Length	Model No.	1-24	25-49	50-99
Standard Flexible Cable Assemblies							
See website for the following cable(s)							
52 Ohm, RG8A/U Coax				PE3098			9
50 Ohm, RG58C/U Coax							
0.195" dia.	20 dB / 100 ft.	44 W	12"	PE3516-12	\$53.85	\$50.08	\$46.31
			24"	PE3516-24	\$54.40	\$50.59	\$46.78
			36"	PE3516-36	\$54.90	\$51.06	\$47.21
			48"	PE3516-48	\$55.45	\$51.57	\$47.69
			60"	PE3516-60	\$56.00	\$52.08	\$48.16
Any	PE3516-XX	See Website for Pricing					
See website for the following cable(s)							
50 Ohm, RG142B/U Coax				PE3914			11
50 Ohm, RG174A/U Coax							
0.100" dia.	31 dB / 100 ft.	16 W	12"	PE34427-12	\$62.20	\$57.85	\$53.49
			24"	PE34427-24	\$62.70	\$58.31	\$53.92
			36"	PE34427-36	\$63.00	\$58.59	\$54.18
			48"	PE34427-48	\$63.45	\$59.01	\$54.57
			60"	PE34427-60	\$63.90	\$59.43	\$54.95
Any	PE34427-XX	See Website for Pricing					
See website for the following cable(s)							
50 Ohm, RG214/U Coax				PE3735			13
50 Ohm, RG223/U Coax							
0.216" dia.	16.5 dB / 100 ft.	53 W	12"	PE3694-12	\$41.50	\$38.60	\$35.69
			24"	PE3694-24	\$43.70	\$40.64	\$37.58
			36"	PE3694-36	\$45.95	\$42.73	\$39.52
			48"	PE3694-48	\$48.15	\$44.78	\$41.41
			60"	PE3694-60	\$50.35	\$46.83	\$43.30
Any	PE3694-XX	See Website for Pricing					
See website for the following cable(s)							
50 Ohm, RG316/U Coax				PE34433			15
50 Ohm, RG393/U Coax				PE3577			16
50 Ohm, RG400/U Coax				PE34425			17

### MHV MALE TO SHV PLUG





Cable Model No.

Standard Flexible Cable Assemblies

See website for the following cable(s)		
52 Ohm, RG8A/U Coax	PE3365	18
50 Ohm, RG58C/U Coax	PE3950	19
50 Ohm, RG142B/U Coax	PE3085	20
50 Ohm, RG174A/U Coax	PE34419	21
50 Ohm, RG223/U Coax	PE34411	22

SHV PLUG TO SHV PLUG							
							
Cable Dia.	Atten.*	Max Power*	Length	Model No.	1-24	25-49	50-99
Standard Flexible Cable Assemblies							
<b>52 Ohm, RG8A/U Coax</b>							
0.405" dia.	9 dB / 100 ft.	190 W	12"	PE33068-12	\$95.55	\$88.86	\$82.17
			24"	PE33068-24	\$96.65	\$89.88	\$83.12
			36"	PE33068-36	\$97.65	\$90.81	\$83.98
			48"	PE33068-48	\$98.80	\$91.88	\$84.97
			60"	PE33068-60	\$99.75	\$92.77	\$85.79
Any	PE33068-XX	See Website for Pricing					
<b>50 Ohm, RG58C/U Coax</b>							
0.195" dia.	20 dB / 100 ft.	44 W	12"	PE3815-12	\$81.95	\$76.21	\$70.48
			24"	PE3815-24	\$82.35	\$76.59	\$70.82
			36"	PE3815-36	\$82.85	\$77.05	\$71.25
			48"	PE3815-48	\$83.20	\$77.38	\$71.55
			60"	PE3815-60	\$83.65	\$77.79	\$71.94
Any	PE3815-XX	See Website for Pricing					
See website for the following cable(s)							
50 Ohm, RG141A/U Coax				PE34428			
50 Ohm, RG142B/U Coax				PE3843			
50 Ohm, RG174A/U Coax				PE33706			
50 Ohm, RG188A/U Coax				PE34430			
50 Ohm, RG213/U Coax				PE35384			
<b>50 Ohm, RG214/U Coax</b>							
0.425" dia.	9 dB / 100 ft.	190 W	12"	PE3117-12	\$102.45	\$95.28	\$88.11
			24"	PE3117-24	\$106.15	\$98.72	\$91.29
			36"	PE3117-36	\$109.90	\$102.21	\$94.51
			48"	PE3117-48	\$113.55	\$105.60	\$97.65
			60"	PE3117-60	\$117.30	\$109.09	\$100.88
Any	PE3117-XX	See Website for Pricing					
<b>50 Ohm, RG223/U Coax</b>							
0.216" dia.	16.5 dB / 100 ft.	53 W	12"	PE3992-12	\$81.95	\$76.21	\$70.48
			24"	PE3992-24	\$83.35	\$77.52	\$71.68
			36"	PE3992-36	\$84.65	\$78.72	\$72.80
			48"	PE3992-48	\$86.00	\$79.98	\$73.96
			60"	PE3992-60	\$87.40	\$81.28	\$75.16
Any	PE3992-XX	See Website for Pricing					
See website for the following cable(s)							
50 Ohm, RG225/U Coax				PE34421			
50 Ohm, RG316/U Coax				PE34432			
50 Ohm, RG393/U Coax				PE3338			
50 Ohm, RG400/U Coax				PE34424			
50 Ohm, PE-P195 Coax				PE39229			

C MALE TO C MALE							
							
Cable							Model No.
Standard Flexible Cable Assemblies							
See website for the following cable(s)							
52 Ohm, RG8A/U Coax				PE33316			
50 Ohm, RG58C/U Coax				PE3457			
50 Ohm, RG142B/U Coax				PE3518			
50 Ohm, RG214/U Coax				PE3605			
50 Ohm, RG217/U Coax				PE34437			
50 Ohm, RG223/U Coax				PE3343			
50 Ohm, RG393/U Coax				PE3120			

75 OHM N MALE TO 75 OHM N MALE							
							
Cable Dia.	Atten.*	Max Power*	Length	Model No.	1-24	25-49	50-99
Standard Flexible Cable Assemblies							
<b>75 Ohm, RG6A/U Coax</b>							
0.332" dia.	11 dB / 100 ft.	125 W	12"	PE3612-12	\$44.65	\$41.52	\$38.40
			24"	PE3612-24	\$46.10	\$42.87	\$39.65
			36"	PE3612-36	\$47.55	\$44.22	\$40.89
			48"	PE3612-48	\$49.00	\$45.57	\$42.14
			60"	PE3612-60	\$50.45	\$46.92	\$43.39
Any	PE3612-XX	See Website for Pricing					
See website for the following cable(s)							
75 Ohm, RG11A/U Coax				PE3616			
<b>75 Ohm, RG59B/U Coax</b>							
0.242" dia.	11.5 dB / 100 ft.	77 W	12"	PE3528-12	\$45.05	\$41.90	\$38.74
			24"	PE3528-24	\$45.40	\$42.22	\$39.04
			36"	PE3528-36	\$45.90	\$42.69	\$39.47
			48"	PE3528-48	\$46.35	\$43.11	\$39.86
			60"	PE3528-60	\$46.85	\$43.57	\$40.29
Any	PE3528-XX	See Website for Pricing					
See website for the following cable(s)							
75 Ohm, RG179B/U Coax				PE3307			
75 Ohm, RG187A/U Coax				PE3581			
75 Ohm, RG216/U Coax				PE3618			

75 OHM N MALE TO 75 OHM BNC MALE							
							
Cable							Model No.
Standard Flexible Cable Assemblies							
See website for the following cable(s)							
75 Ohm, RG6A/U Coax				PE3341			
75 Ohm, RG11A/U Coax				PE3396			
75 Ohm, RG59B/U Coax				PE33605			
75 Ohm, RG179B/U Coax				PE3398			
75 Ohm, RG216/U Coax				PE3404			

75 OHM TNC MALE TO 75 OHM TNC MALE							
							
Cable							Model No.
Standard Flexible Cable Assemblies							
See website for the following cable(s)							
75 Ohm, RG6A/U Coax				PE35348			
75 Ohm, RG11A/U Coax				PE35352			
75 Ohm, RG59B/U Coax				PE35356			

75 OHM TNC MALE TO 75 OHM BNC MALE							
							
Cable							Model No.
Standard Flexible Cable Assemblies							
See website for the following cable(s)							
75 Ohm, RG6A/U Coax				PE35350			
75 Ohm, RG59B/U Coax				PE35358			
75 Ohm, RG179B/U Coax				PE35362			

\*Coax Performance at 1 GHz  
Notes: Cable assembly max frequency may be lower than connector or coax max frequency

Continued on Next Page

Continued from Previous Page

75 OHM TNC MALE TO 75 OHM BNC MALE



Cable	Model No.	
75 Ohm, RG216/U Coax	PE35370	1

75 OHM SMC PLUG TO 75 OHM SMC PLUG



Cable	Model No.	
Standard Flexible Cable Assemblies		
See website for the following cable(s)		
75 Ohm, RG179B/U Coax	PE3376	2

75 OHM SMC PLUG TO 75 OHM BNC MALE



Cable Dia.	Atten.*	Max Power*	Length	Model No.	1-24	25-49	50-99		
Standard Flexible Cable Assemblies									
See website for the following cable(s)									
75 Ohm, RG59B/U Coax				PE33330					3
75 Ohm, RG179B/U Coax									
0.100" dia.	25 dB / 100 ft.	200 W	12"	PE33586-12	\$41.55	\$38.64	\$35.73	4	
			24"	PE33586-24	\$43.45	\$40.41	\$37.37		
			36"	PE33586-36	\$45.30	\$42.13	\$38.96		
			48"	PE33586-48	\$47.20	\$43.90	\$40.59		
			60"	PE33586-60	\$49.10	\$45.66	\$42.23		
Any	PE33586-XX	See Website for Pricing							
See website for the following cable(s)									
75 Ohm, PE-B150 Coax				PE33646					5

75 OHM F MALE TO 75 OHM F MALE



Cable Dia.	Atten.*	Max Power*	Length	Model No.	1-24	25-49	50-99		
Standard Flexible Cable Assemblies									
See website for the following cable(s)									
75 Ohm, RG6A/U Coax				PE37163					6
75 Ohm, RG6-CATV Coax									
0.275" dia.	6.5 dB / 100 ft.	6.5 W	12"	PE36132-12	\$14.80	\$13.76	\$12.73	7	
			24"	PE36132-24	\$16.10	\$14.97	\$13.85		
			36"	PE36132-36	\$17.35	\$16.14	\$14.92		
			48"	PE36132-48	\$18.15	\$16.88	\$15.61		
			60"	PE36132-60	\$18.95	\$17.62	\$16.30		
Any	PE36132-XX	See Website for Pricing							
75 Ohm, RG11A/U Coax									
0.405" dia.	9 dB / 100 ft.	150 W	12"	PE36135-12	\$16.35	\$15.21	\$14.06	8	
			24"	PE36135-24	\$18.00	\$16.74	\$15.48		
			36"	PE36135-36	\$19.35	\$18.00	\$16.64		
			48"	PE36135-48	\$20.75	\$19.30	\$17.85		
			60"	PE36135-60	\$22.20	\$20.65	\$19.09		
Any	PE36135-XX	See Website for Pricing							

75 OHM F MALE TO 75 OHM F MALE



Cable Dia.	Atten.*	Max Power*	Length	Model No.	1-24	25-49	50-99		
75 Ohm, RG59B/U Coax									
0.242" dia.	11.5 dB / 100 ft.	77 W	12"	PE36141-12	\$11.35	\$10.56	\$9.76	9	
			24"	PE36141-24	\$12.05	\$11.21	\$10.36		
			36"	PE36141-36	\$12.80	\$11.90	\$11.01		
			48"	PE36141-48	\$13.50	\$12.56	\$11.61		
			60"	PE36141-60	\$14.25	\$13.25	\$12.26		
Any	PE36141-XX	See Website for Pricing							
See website for the following cable(s)									
75 Ohm, RG59-WHITE Coax				PE36143					10
75 Ohm, RG179B/U Coax									
0.100" dia.	25 dB / 100 ft.	200 W	12"	PE36137-12	\$18.20	\$16.93	\$15.65	11	
			24"	PE36137-24	\$19.60	\$18.23	\$16.86		
			36"	PE36137-36	\$21.20	\$19.72	\$18.23		
			48"	PE36137-48	\$22.50	\$20.93	\$19.35		
			60"	PE36137-60	\$23.90	\$22.23	\$20.55		
Any	PE36137-XX	See Website for Pricing							
See website for the following cable(s)									
75 Ohm, RG187A/U Coax				PE36139					12

75 OHM F MALE TO 75 OHM F MALE RIGHT ANGLE



Cable	Model No.	
Standard Flexible Cable Assemblies		
See website for the following cable(s)		
75 Ohm, RG59B/U Coax	PE38343	13

75 OHM F MALE TO 75 OHM BNC MALE



Cable Dia.	Atten.*	Max Power*	Length	Model No.	1-24	25-49	50-99		
Standard Flexible Cable Assemblies									
75 Ohm, RG6-CATV Coax									
0.275" dia.	6.5 dB / 100 ft.	6.5 W	12"	PE36145-12	\$21.85	\$20.32	\$18.79	14	
			24"	PE36145-24	\$23.25	\$21.62	\$20.00		
			36"	PE36145-36	\$24.70	\$22.97	\$21.24		
			48"	PE36145-48	\$26.05	\$24.23	\$22.40		
			60"	PE36145-60	\$27.45	\$25.53	\$23.61		
Any	PE36145-XX	See Website for Pricing							
75 Ohm, RG59B/U Coax									
0.242" dia.	11.5 dB / 100 ft.	77 W	12"	PE36149-12	\$19.55	\$18.18	\$16.81	15	
			24"	PE36149-24	\$20.35	\$18.93	\$17.50		
			36"	PE36149-36	\$20.80	\$19.34	\$17.89		
			48"	PE36149-48	\$21.55	\$20.04	\$18.53		
			60"	PE36149-60	\$22.10	\$20.55	\$19.01		
Any	PE36149-XX	See Website for Pricing							
See website for the following cable(s)									
75 Ohm, RG59-WHITE Coax				PE36151					16
75 Ohm, RG179B/U Coax									
0.100" dia.	25 dB / 100 ft.	200 W	12"	PE36153-12	\$23.55	\$21.90	\$20.25	17	
			24"	PE36153-24	\$25.05	\$23.30	\$21.54		
			36"	PE36153-36	\$26.45	\$24.60	\$22.75		
			48"	PE36153-48	\$27.80	\$25.85	\$23.91		
			60"	PE36153-60	\$29.25	\$27.20	\$25.16		
Any	PE36153-XX	See Website for Pricing							

Cable Assemblies

\*Coax Performance at 1 GHz  
Notes: Cable assembly max frequency may be lower than connector or coax max frequency

Continued on Next Page

ROHS & REACH COMPLIANT. CUSTOM-LENGTH CABLE ASSEMBLIES MAY BE ORDERED ON OUR WEBSITE.

Continued from Previous Page

75 OHM F MALE TO  
75 OHM BNC MALE



Cable Dia.	Atten.*	Max Power*	Length	Model No.	1-24	25-49	50-99
------------	---------	------------	--------	-----------	------	-------	-------

<b>See website for the following cable(s)</b>								
75 Ohm, RG187A/U Coax				PE36155				1

75 OHM 1.6/5.6 PLUG TO  
75 OHM BNC MALE



Cable	Model No.
-------	-----------

Standard Flexible Cable Assemblies

<b>See website for the following cable(s)</b>								
75 Ohm, RG59B/U Coax				PE36127				2

75 OHM SMB PLUG TO  
75 OHM SMB PLUG



Cable Dia.	Atten.*	Max Power*	Length	Model No.	1-24	25-49	50-99
------------	---------	------------	--------	-----------	------	-------	-------

Standard Flexible Cable Assemblies

<b>See website for the following cable(s)</b>								
75 Ohm, RG59B/U Coax				PE3041				3

75 Ohm, RG179B/U Coax								
0.100" dia.	25 dB / 100 ft.	200 W	Length	Model No.	\$47.75	\$44.41	\$41.07	
			12"	PE3100-12	\$47.75	\$44.41	\$41.07	
			24"	PE3100-24	\$48.80	\$45.38	\$41.97	
			36"	PE3100-36	\$49.80	\$46.31	\$42.83	
			48"	PE3100-48	\$50.75	\$47.20	\$43.65	
			60"	PE3100-60	\$51.80	\$48.17	\$44.55	
			Any	PE3100-XX	See Website for Pricing			4

75 OHM SMB PLUG TO  
75 OHM BNC MALE



Cable Dia.	Atten.*	Max Power*	Length	Model No.	1-24	25-49	50-99
------------	---------	------------	--------	-----------	------	-------	-------

Standard Flexible Cable Assemblies

<b>See website for the following cable(s)</b>								
75 Ohm, RG59B/U Coax				PE33270				5

75 Ohm, RG179B/U Coax								
0.100" dia.	25 dB / 100 ft.	200 W	Length	Model No.	\$41.00	\$38.13	\$35.26	
			12"	PE33247-12	\$41.00	\$38.13	\$35.26	
			24"	PE33247-24	\$41.95	\$39.01	\$36.08	
			36"	PE33247-36	\$43.45	\$40.41	\$37.37	
			48"	PE33247-48	\$45.30	\$42.13	\$38.96	
			60"	PE33247-60	\$47.20	\$43.90	\$40.59	
			Any	PE33247-XX	See Website for Pricing			6

75 OHM MINI SMB PLUG TO  
75 OHM MINI SMB PLUG



Cable	Model No.
-------	-----------

Standard Flexible Cable Assemblies

<b>See website for the following cable(s)</b>								
75 Ohm, RG59B/U Coax				PE34681				7
75 Ohm, RG179B/U Coax				PE34683				8

75 OHM MINI SMB PLUG TO 75 OHM  
MINI SMB PLUG RIGHT ANGLE



Cable	Model No.
-------	-----------

Standard Flexible Cable Assemblies

<b>See website for the following cable(s)</b>								
75 Ohm, RG59B/U Coax				PE34687				9
75 Ohm, RG179B/U Coax				PE34689				10

75 OHM MINI SMB PLUG RIGHT  
ANGLE TO 75 OHM MINI SMB PLUG  
RIGHT ANGLE



Cable	Model No.
-------	-----------

Standard Flexible Cable Assemblies

<b>See website for the following cable(s)</b>								
75 Ohm, RG179B/U Coax				PE34694				11

75 OHM MINI SMB PLUG TO  
75 OHM BNC MALE



Cable	Model No.
-------	-----------

Standard Flexible Cable Assemblies

<b>See website for the following cable(s)</b>								
75 Ohm, RG59B/U Coax				PE34701				12
75 Ohm, RG179B/U Coax				PE34703				13
75 Ohm, RG187A/U Coax				PE34705				14
75 Ohm, PE-B159-BK Coax				PE38040/BK				15
75 Ohm, PE-B159-BL Coax				PE38040/BL				
75 Ohm, PE-B159-GR Coax				PE38040/GR				
75 Ohm, PE-B159-RD Coax				PE38040/RD				
75 Ohm, PE-B159-WH Coax				PE38040/WH				
75 Ohm, PE-B159-YW Coax				PE38040/YW				16

75 OHM RCA MALE TO 75 OHM  
RCA FEMALE BULKHEAD

SEE MOUNTING HOLE SECTION ON PAGE 246



Cable	Model No.
-------	-----------

Standard Flexible Cable Assemblies

<b>See website for the following cable(s)</b>								
75 Ohm, PE-B159-BK Coax				PE38135/BK				16
75 Ohm, PE-B159-BL Coax				PE38135/BL				
75 Ohm, PE-B159-GR Coax				PE38135/GR				
75 Ohm, PE-B159-RD Coax				PE38135/RD				
75 Ohm, PE-B159-WH Coax				PE38135/WH				
75 Ohm, PE-B159-YW Coax				PE38135/YW				

Coaxial cable was invented by English engineer and mathematician Oliver Heaviside, who patented the design in 1880.

Cable Assemblies

\*Coax Performance at 1 GHz  
Notes: Cable assembly max frequency may be lower than connector or coax max frequency



Free Freight Available  
via UPS Ground  
to USA & Canada



Real-Time Stock  
Levels & Pricing  
On Our WebSite



Toll-Free Technical  
Support  
(866) 727-8376



Same-Day Shipping,  
Even Custom  
Cable Assemblies



Cable Assemblies

\*Coax Performance at 1 GHz  
Notes: Cable assembly max frequency may be lower than connector or coax max frequency

### 75 OHM BNC MALE TO 75 OHM BNC MALE



Cable Dia.	Atten.*	Max Power*	Length	Model No.	1-24	25-49	50-99
------------	---------	------------	--------	-----------	------	-------	-------

#### Standard Flexible Cable Assemblies

75 Ohm, RG6A/U Coax							
0.332" dia.	11 dB / 100 ft.	125 W	12"	PE33197-12	\$41.90	\$38.97	\$36.03
			24"	PE33197-24	\$43.35	\$40.32	\$37.28
			36"	PE33197-36	\$44.80	\$41.66	\$38.53
			48"	PE33197-48	\$46.25	\$43.01	\$39.78
			60"	PE33197-60	\$47.70	\$44.36	\$41.02
			Any	PE33197-XX	See Website for Pricing		

75 Ohm, RG6-CATV Coax							
0.275" dia.	6.5 dB / 100 ft.	6.5 W	12"	PE37808-12	\$41.25	\$38.36	\$35.48
			24"	PE37808-24	\$42.00	\$39.06	\$36.12
			36"	PE37808-36	\$42.80	\$39.80	\$36.81
			48"	PE37808-48	\$43.60	\$40.55	\$37.50
			60"	PE37808-60	\$44.40	\$41.29	\$38.18
			Any	PE37808-XX	See Website for Pricing		

#### See website for the following cable(s)

75 Ohm, RG11A/U Coax	PE33399
----------------------	---------

75 Ohm, RG59B/U Coax							
0.242" dia.	11.5 dB / 100 ft.	77 W	12"	PE33188-12	\$31.55	\$29.34	\$27.13
			24"	PE33188-24	\$32.25	\$29.99	\$27.74
			36"	PE33188-36	\$33.00	\$30.69	\$28.38
			48"	PE33188-48	\$33.70	\$31.34	\$28.98
			60"	PE33188-60	\$34.45	\$32.04	\$29.63
			Any	PE33188-XX	See Website for Pricing		

75 Ohm, RG179B/U Coax							
0.100" dia.	25 dB / 100 ft.	200 W	12"	PE33401-12	\$37.40	\$34.78	\$32.16
			24"	PE33401-24	\$39.30	\$36.55	\$33.80
			36"	PE33401-36	\$41.15	\$38.27	\$35.39
			48"	PE33401-48	\$43.05	\$40.04	\$37.02
			60"	PE33401-60	\$44.55	\$41.43	\$38.31
			Any	PE33401-XX	See Website for Pricing		

75 Ohm, RG216/U Coax							
0.425" dia.	9 dB / 100 ft.	150 W	12"	PE33403-12	\$48.65	\$45.24	\$41.84
			24"	PE33403-24	\$49.90	\$46.41	\$42.91
			36"	PE33403-36	\$51.35	\$47.76	\$44.16
			48"	PE33403-48	\$52.90	\$49.20	\$45.49
			60"	PE33403-60	\$54.30	\$50.50	\$46.70
			Any	PE33403-XX	See Website for Pricing		

75 Ohm, PE-B150 Coax							
0.150" dia.	20 dB / 100 ft.	25 W	12"	PE33405-12	\$35.30	\$32.83	\$30.36
			24"	PE33405-24	\$35.90	\$33.39	\$30.87
			36"	PE33405-36	\$36.50	\$33.95	\$31.39
			48"	PE33405-48	\$37.05	\$34.46	\$31.86
			60"	PE33405-60	\$37.65	\$35.01	\$32.38
			Any	PE33405-XX	See Website for Pricing		

### 75 OHM BNC MALE TO 75 OHM BNC MALE RIGHT ANGLE



Cable Dia.	Atten.*	Max Power*	Length	Model No.	1-24	25-49	50-99
------------	---------	------------	--------	-----------	------	-------	-------

#### Standard Flexible Cable Assemblies

#### See website for the following cable(s)

75 Ohm, RG6A/U Coax	PE33407
---------------------	---------

### 75 OHM BNC MALE TO 75 OHM BNC MALE RIGHT ANGLE



Cable Dia.	Atten.*	Max Power*	Length	Model No.	1-24	25-49	50-99
------------	---------	------------	--------	-----------	------	-------	-------

#### 75 Ohm, RG59B/U Coax

0.242" dia.	11.5 dB / 100 ft.	77 W	12"	PE33196-12	\$45.95	\$42.73	\$39.52
			24"	PE33196-24	\$46.70	\$43.43	\$40.16
			36"	PE33196-36	\$47.45	\$44.13	\$40.81
			48"	PE33196-48	\$48.15	\$44.78	\$41.41
			60"	PE33196-60	\$48.90	\$45.48	\$42.05
			Any	PE33196-XX	See Website for Pricing		

#### 75 Ohm, RG179B/U Coax

0.100" dia.	25 dB / 100 ft.	200 W	12"	PE33412-12	\$46.35	\$43.11	\$39.86
			24"	PE33412-24	\$48.25	\$44.87	\$41.50
			36"	PE33412-36	\$50.15	\$46.64	\$43.13
			48"	PE33412-48	\$52.00	\$48.36	\$44.72
			60"	PE33412-60	\$53.90	\$50.13	\$46.35
			Any	PE33412-XX	See Website for Pricing		

#### See website for the following cable(s)

75 Ohm, RG187A/U Coax	PE33414
-----------------------	---------

### 75 OHM BNC MALE TO 75 OHM BNC FEMALE



Cable	Model No.
-------	-----------

#### Standard Flexible Cable Assemblies

#### See website for the following cable(s)

75 Ohm, RG6A/U Coax	PE33437	12
75 Ohm, RG59B/U Coax	PE33441	13
75 Ohm, RG179B/U Coax	PE33443	14

### 75 OHM BNC MALE TO 75 OHM BNC FEMALE BULKHEAD

SEE MOUNTING HOLE SECTION ON PAGE 246



Cable Dia.	Atten.*	Max Power*	Length	Model No.	1-24	25-49	50-99
------------	---------	------------	--------	-----------	------	-------	-------

#### Standard Flexible Cable Assemblies

#### 75 Ohm, RG59B/U Coax

0.242" dia.	11.5 dB / 100 ft.	77 W	12"	PE33179-12	\$45.05	\$41.90	\$38.74
			24"	PE33179-24	\$45.40	\$42.22	\$39.04
			36"	PE33179-36	\$45.90	\$42.69	\$39.47
			48"	PE33179-48	\$46.35	\$43.11	\$39.86
			60"	PE33179-60	\$46.75	\$43.48	\$40.21
			Any	PE33179-XX	See Website for Pricing		

#### See website for the following cable(s)

75 Ohm, RG179B/U Coax	PE33421	16
-----------------------	---------	----

**The Banana connector, also referred to as a 4mm connector, was invented by Richard Hirschmann in 1924.**

### 75 OHM BNC MALE RIGHT ANGLE TO 75 OHM BNC MALE RIGHT ANGLE



Cable Dia.	Atten.*	Max Power*	Length	Model No.	1-24	25-49	50-99
Standard Flexible Cable Assemblies							
<b>75 Ohm, RG59B/U Coax</b>							
0.242" dia.	11.5 dB / 100 ft.	77 W	12"	PE33430-12	\$60.40	\$56.17	\$51.94
			24"	PE33430-24	\$61.15	\$56.87	\$52.59
			36"	PE33430-36	\$61.85	\$57.52	\$53.19
			48"	PE33430-48	\$62.60	\$58.22	\$53.84
			60"	PE33430-60	\$63.35	\$58.92	\$54.48
			Any	PE33430-XX	See Website for Pricing		
<b>See website for the following cable(s)</b>							
75 Ohm, RG179B/U Coax				PE33432			
75 Ohm, RG187A/U Coax				PE33434			

### 75 OHM BNC FEMALE TO 75 OHM BNC FEMALE



Cable	Model No.
Standard Flexible Cable Assemblies	
<b>See website for the following cable(s)</b>	
75 Ohm, RG11A/U Coax	PE33450
75 Ohm, RG59B/U Coax	PE33452
75 Ohm, RG179B/U Coax	PE33451
75 Ohm, RG187A/U Coax	PE33456

### BNC TWINAX PLUG TO BNC TWINAX PLUG



Cable Dia.	Atten.*	Max Power*	Length	Model No.	1-24	25-49	50-99
Standard Flexible Cable Assemblies							
<b>78 Ohm, RG108A/U Twinax</b>							
0.235" dia.	26.2 dB / 100 ft.	30 W	18"	PE3480-18	\$80.70	\$75.05	\$69.40
			36"	PE3480-36	\$81.60	\$75.89	\$70.18
			60"	PE3480-60	\$82.90	\$77.10	\$71.29
			90"	PE3480-90	\$84.40	\$78.49	\$72.58
			120"	PE3480-120	\$85.95	\$79.93	\$73.92
			180"	PE3480-180	\$89.10	\$82.86	\$76.63
			Any	PE3480-XX	See Website for Pricing		

### 3/4" -20 MALE TO 3/4" -20 MALE



Cable Dia.	Atten.*	Max Power*	Length	Model No.	1-24	25-49	50-99
Standard Flexible Cable Assemblies							
<b>100 Ohm, PE-S330 Twinax</b>							
0.330" dia.	N/A dB / 100 ft.	N/A W	18"	PE3930-18	\$60.15	\$55.94	\$51.73
			36"	PE3930-36	\$62.80	\$58.40	\$54.01
			60"	PE3930-60	\$66.30	\$61.66	\$57.02
			90"	PE3930-90	\$70.75	\$65.80	\$60.85
			120"	PE3930-120	\$75.05	\$69.80	\$64.54
			180"	PE3930-180	\$84.00	\$78.12	\$72.24
			Any	PE3930-XX	See Website for Pricing		

### BANANA PLUG TO BANANA PLUG





Cable Dia.	Atten.*	Max Power*	Length	Model No.	1-24	25-49	50-99			
Standard Flexible Cable Assemblies										
<b>See website for the following cable(s)</b>										
50 Ohm, RG58C/U Coax				PE3005						
50 Ohm, RG142B/U Coax				PE33446						
50 Ohm, RG223/U Coax				PE33449						
<b>BLACK WIRE</b>										
dia.	- / 100 ft.	W	6"	PE9930-6-B	\$6.28	\$5.84	\$5.40			
			12"	PE9930-12-B	\$6.43	\$5.98	\$5.53			
			18"	PE9930-18-B	\$6.64	\$6.18	\$5.71			
			24"	PE9930-24-B	\$6.98	\$6.49	\$6.00			
			36"	PE9930-36-B	\$6.94	\$6.45	\$5.97			
			48"	PE9930-48-B	\$7.19	\$6.69	\$6.18			
			60"	PE9930-60-B	\$7.40	\$6.88	\$6.36			
			72"	PE9930-72-B	\$7.70	\$7.16	\$6.62			
			120"	PE9930-120-B	\$8.31	\$7.73	\$7.15			
			144"	PE9930-144-B	\$8.77	\$8.16	\$7.54			
						Any	PE9930-XX-B	See Website for Pricing		
			<b>RED WIRE</b>							
dia.	- / 100 ft.	W	6"	PE9930-6-R	\$6.28	\$5.84	\$5.40			
			12"	PE9930-12-R	\$6.54	\$6.08	\$5.62			
			18"	PE9930-18-R	\$6.64	\$6.18	\$5.71			
			24"	PE9930-24-R	\$6.74	\$6.27	\$5.80			
			36"	PE9930-36-R	\$6.94	\$6.45	\$5.97			
			48"	PE9930-48-R	\$7.19	\$6.69	\$6.18			
			60"	PE9930-60-R	\$7.40	\$6.88	\$6.36			
			72"	PE9930-72-R	\$7.75	\$7.21	\$6.67			
			120"	PE9930-120-R	\$8.31	\$7.73	\$7.15			
			144"	PE9930-144-R	\$8.77	\$8.16	\$7.54			
						Any	PE9930-XX-R	See Website for Pricing		

### BANANA PLUG TO ALLIGATOR CLIP



Cable Dia.	Atten.*	Max Power*	Length	Model No.	1-24	25-49	50-99			
Standard Flexible Cable Assemblies										
<b>See website for the following cable(s)</b>										
50 Ohm, RG58C/U Coax				PE3502						
50 Ohm, RG223/U Coax				PE3164						
<b>BLACK WIRE</b>										
dia.	- / 100 ft.	W	6"	PE9931-6-B	\$7.70	\$7.16	\$6.62			
			12"	PE9931-12-B	\$7.85	\$7.30	\$6.75			
			18"	PE9931-18-B	\$8.20	\$7.63	\$7.05			
			24"	PE9931-24-B	\$8.30	\$7.72	\$7.14			
			36"	PE9931-36-B	\$8.55	\$7.95	\$7.35			
			48"	PE9931-48-B	\$8.90	\$8.28	\$7.65			
			60"	PE9931-60-B	\$9.15	\$8.51	\$7.87			
			72"	PE9931-72-B	\$9.45	\$8.79	\$8.13			
						Any	PE9931-XX-B	See Website for Pricing		
			<b>RED WIRE</b>							
			dia.	- / 100 ft.	W	6"	PE9931-6-R	\$7.70	\$7.16	\$6.62
						12"	PE9931-12-R	\$7.85	\$7.30	\$6.75
18"	PE9931-18-R	\$8.20				\$7.63	\$7.05			
24"	PE9931-24-R	\$8.30				\$7.72	\$7.14			
36"	PE9931-36-R	\$8.55				\$7.95	\$7.35			
48"	PE9931-48-R	\$8.90				\$8.28	\$7.65			
60"	PE9931-60-R	\$9.15				\$8.51	\$7.87			
72"	PE9931-72-R	\$9.45				\$8.79	\$8.13			
						Any	PE9931-XX-R	See Website for Pricing		

BANANA PLUG TO MINI ALLIGATOR CLIP								
ALL OF COLOR PATCH CORDS ARE RATED 2500 V, 5 AMPS AND +50° C.								
								
Cable Dia.	Atten.*	Max Power*	Length	Model No.	1-24	25-49	50-99	
Standard Flexible Cable Assemblies								
<b>BLACK WIRE</b>								
-	/ 100 ft.	-	W	6"	PE9933-6-B	\$7.70	\$7.16	\$6.62
				12"	PE9933-12-B	\$7.85	\$7.30	\$6.75
				18"	PE9933-18-B	\$8.20	\$7.63	\$7.05
				24"	PE9933-24-B	\$8.30	\$7.72	\$7.14
				36"	PE9933-36-B	\$8.55	\$7.95	\$7.35
				48"	PE9933-48-B	\$8.90	\$8.28	\$7.65
				60"	PE9933-60-B	\$9.15	\$8.51	\$7.87
				72"	PE9933-72-B	\$9.45	\$8.79	\$8.13
				Any	PE9933-XX-B	See Website for Pricing		
<b>RED WIRE</b>								
-	/ 100 ft.	-	W	6"	PE9933-6-R	\$7.70	\$7.16	\$6.62
				12"	PE9933-12-R	\$7.85	\$7.30	\$6.75
				18"	PE9933-18-R	\$8.20	\$7.63	\$7.05
				24"	PE9933-24-R	\$8.30	\$7.72	\$7.14
				36"	PE9933-36-R	\$8.55	\$7.95	\$7.35
				48"	PE9933-48-R	\$8.90	\$8.28	\$7.65
				60"	PE9933-60-R	\$9.15	\$8.51	\$7.87
				72"	PE9933-72-R	\$9.45	\$8.79	\$8.13
				Any	PE9933-XX-R	See Website for Pricing		

ALLIGATOR CLIP TO ALLIGATOR CLIP											
ALL OF COLOR PATCH CORDS ARE RATED 2500 V, 5 AMPS AND +50° C.											
											
Cable Dia.	Atten.*	Max Power*	Length	Model No.	1-24	25-49	50-99				
Standard Flexible Cable Assemblies											
<b>BLACK WIRE</b>											
-	/ 100 ft.	-	W	6"	PE9932-6-B	\$7.70	\$7.16	\$6.62			
				12"	PE9932-12-B	\$7.85	\$7.30	\$6.75			
				18"	PE9932-18-B	\$8.20	\$7.63	\$7.05			
				24"	PE9932-24-B	\$8.30	\$7.72	\$7.14			
				30"	PE9932-30-B	\$8.45	\$7.86	\$7.27			
				36"	PE9932-36-B	\$8.55	\$7.95	\$7.35			
				48"	PE9932-48-B	\$8.90	\$8.28	\$7.65			
				60"	PE9932-60-B	\$9.15	\$8.51	\$7.87			
				72"	PE9932-72-B	\$9.45	\$8.79	\$8.13			
				Any	PE9932-XX-B	See Website for Pricing					
				<b>RED WIRE</b>							
-	/ 100 ft.	-	W	6"	PE9932-6-R	\$7.70	\$7.16	\$6.62			
				12"	PE9932-12-R	\$7.85	\$7.30	\$6.75			
				18"	PE9932-18-R	\$8.20	\$7.63	\$7.05			
				24"	PE9932-24-R	\$8.30	\$7.72	\$7.14			
				30"	PE9932-30-R	\$8.45	\$7.86	\$7.27			
				36"	PE9932-36-R	\$8.55	\$7.95	\$7.35			
				48"	PE9932-48-R	\$8.90	\$8.28	\$7.65			
				60"	PE9932-60-R	\$9.15	\$8.51	\$7.87			
				72"	PE9932-72-R	\$9.45	\$8.79	\$8.13			
				Any	PE9932-XX-R	See Website for Pricing					

BANANA PLUG TO SPADE LUG								
ALL OF COLOR PATCH CORDS ARE RATED 2500 V, 5 AMPS AND +50° C.								
								
Cable Dia.	Atten.*	Max Power*	Length	Model No.	1-24	25-49	50-99	
Standard Flexible Cable Assemblies								
<b>BLACK WIRE</b>								
-	/ 100 ft.	-	W	6"	PE9936-6-B	\$7.70	\$7.16	\$6.62
				12"	PE9936-12-B	\$7.85	\$7.30	\$6.75
				18"	PE9936-18-B	\$8.20	\$7.63	\$7.05
				24"	PE9936-24-B	\$8.30	\$7.72	\$7.14
				36"	PE9936-36-B	\$8.55	\$7.95	\$7.35
				48"	PE9936-48-B	\$8.90	\$8.28	\$7.65
				60"	PE9936-60-B	\$9.15	\$8.51	\$7.87
				72"	PE9936-72-B	\$9.45	\$8.79	\$8.13
				Any	PE9936-XX-B	See Website for Pricing		
<b>RED WIRE</b>								
-	/ 100 ft.	-	W	6"	PE9936-6-R	\$7.70	\$7.16	\$6.62
				12"	PE9936-12-R	\$7.85	\$7.30	\$6.75
				18"	PE9936-18-R	\$8.20	\$7.63	\$7.05
				24"	PE9936-24-R	\$8.30	\$7.72	\$7.14
				36"	PE9936-36-R	\$8.55	\$7.95	\$7.35
				48"	PE9936-48-R	\$8.90	\$8.28	\$7.65
				60"	PE9936-60-R	\$9.15	\$8.51	\$7.87
				72"	PE9936-72-R	\$9.45	\$8.79	\$8.13
				Any	PE9936-XX-R	See Website for Pricing		

ALLIGATOR CLIP TO SPADE LUG											
ALL OF COLOR PATCH CORDS ARE RATED 2500 V, 5 AMPS AND +50° C.											
											
Cable Dia.	Atten.*	Max Power*	Length	Model No.	1-24	25-49	50-99				
Standard Flexible Cable Assemblies											
<b>BLACK WIRE</b>											
-	/ 100 ft.	-	W	6"	PE9935-6-B	\$7.70	\$7.16	\$6.62			
				12"	PE9935-12-B	\$7.85	\$7.30	\$6.75			
				18"	PE9935-18-B	\$8.20	\$7.63	\$7.05			
				24"	PE9935-24-B	\$8.30	\$7.72	\$7.14			
				36"	PE9935-36-B	\$8.55	\$7.95	\$7.35			
				48"	PE9935-48-B	\$8.90	\$8.28	\$7.65			
				60"	PE9935-60-B	\$9.15	\$8.51	\$7.87			
				72"	PE9935-72-B	\$9.45	\$8.79	\$8.13			
				Any	PE9935-XX-B	See Website for Pricing					
				<b>RED WIRE</b>							
				-	/ 100 ft.	-	W	6"	PE9935-6-R	\$7.70	\$7.16
12"	PE9935-12-R	\$7.85	\$7.30					\$6.75			
18"	PE9935-18-R	\$8.20	\$7.63					\$7.05			
24"	PE9935-24-R	\$8.30	\$7.72					\$7.14			
36"	PE9935-36-R	\$8.55	\$7.95					\$7.35			
48"	PE9935-48-R	\$8.90	\$8.28					\$7.65			
60"	PE9935-60-R	\$9.15	\$8.51					\$7.87			
72"	PE9935-72-R	\$9.45	\$8.79					\$8.13			
Any	PE9935-XX-R	See Website for Pricing									

**Heinrich Hertz was the first person  
to demonstrate the existence of radio waves in 1888.**











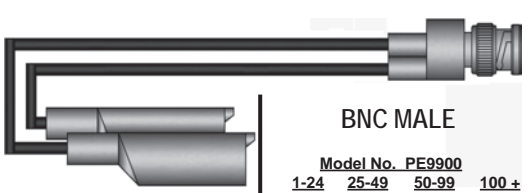
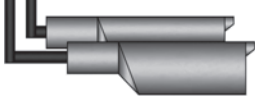
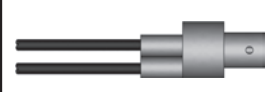
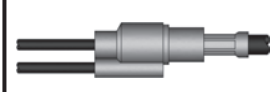
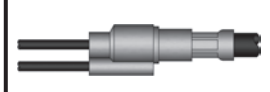

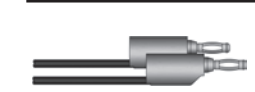
# BREAKOUTS

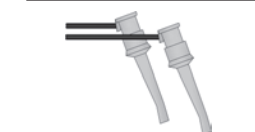
ALL BREAKOUTS HAVE APPROXIMATELY 6" LONG RED AND BLACK LEADS  
 For the complete selection of our cable assemblies, please visit the Cable Assemblies section on our website at [www.pasternack.com](http://www.pasternack.com)

Cable Assemblies

 <b>BNC MALE</b>  <b>STANDARD ALLIGATOR CLIPS</b>	<p>Model No. PE9900</p> <table border="1"> <tr> <td>1-24</td> <td>25-49</td> <td>50-99</td> <td>100+</td> </tr> <tr> <td>\$13.12</td> <td>\$12.20</td> <td>\$11.28</td> <td>\$10.50</td> </tr> </table>	1-24	25-49	50-99	100+	\$13.12	\$12.20	\$11.28	\$10.50	 <b>BNC FEMALE</b> <p>Model No. PE9909</p> <table border="1"> <tr> <td>1-24</td> <td>25-49</td> <td>50-99</td> <td>100+</td> </tr> <tr> <td>\$11.86</td> <td>\$11.03</td> <td>\$10.20</td> <td>\$9.49</td> </tr> </table>	1-24	25-49	50-99	100+	\$11.86	\$11.03	\$10.20	\$9.49	 <b>CRIMP ON FOR RG58</b> <p>Model No. PE9950</p> <table border="1"> <tr> <td>1-24</td> <td>25-49</td> <td>50-99</td> <td>100+</td> </tr> <tr> <td>\$13.32</td> <td>\$12.39</td> <td>\$11.46</td> <td>\$10.66</td> </tr> </table>	1-24	25-49	50-99	100+	\$13.32	\$12.39	\$11.46	\$10.66	 <b>CRIMP ON FOR RG59</b> <p>Model No. PE9959</p> <table border="1"> <tr> <td>1-24</td> <td>25-49</td> <td>50-99</td> <td>100+</td> </tr> <tr> <td>\$13.32</td> <td>\$12.39</td> <td>\$11.46</td> <td>\$10.66</td> </tr> </table>	1-24	25-49	50-99	100+	\$13.32	\$12.39	\$11.46	\$10.66
1-24	25-49	50-99	100+																																	
\$13.12	\$12.20	\$11.28	\$10.50																																	
1-24	25-49	50-99	100+																																	
\$11.86	\$11.03	\$10.20	\$9.49																																	
1-24	25-49	50-99	100+																																	
\$13.32	\$12.39	\$11.46	\$10.66																																	
1-24	25-49	50-99	100+																																	
\$13.32	\$12.39	\$11.46	\$10.66																																	
 <b>MINIATURE ALLIGATOR CLIPS</b>	<p>Model No. PE9901</p> <table border="1"> <tr> <td>1-24</td> <td>25-49</td> <td>50-99</td> <td>100+</td> </tr> <tr> <td>\$13.12</td> <td>\$12.20</td> <td>\$11.28</td> <td>\$10.50</td> </tr> </table>	1-24	25-49	50-99	100+	\$13.12	\$12.20	\$11.28	\$10.50	<p>Model No. PE9910</p> <table border="1"> <tr> <td>1-24</td> <td>25-49</td> <td>50-99</td> <td>100+</td> </tr> <tr> <td>\$11.86</td> <td>\$11.03</td> <td>\$10.20</td> <td>\$9.49</td> </tr> </table>	1-24	25-49	50-99	100+	\$11.86	\$11.03	\$10.20	\$9.49	<p>Model No. PE9951</p> <table border="1"> <tr> <td>1-24</td> <td>25-49</td> <td>50-99</td> <td>100+</td> </tr> <tr> <td>\$12.06</td> <td>\$11.22</td> <td>\$10.37</td> <td>\$9.65</td> </tr> </table>	1-24	25-49	50-99	100+	\$12.06	\$11.22	\$10.37	\$9.65	<p>Model No. PE9960</p> <table border="1"> <tr> <td>1-24</td> <td>25-49</td> <td>50-99</td> <td>100+</td> </tr> <tr> <td>\$13.32</td> <td>\$12.39</td> <td>\$11.46</td> <td>\$10.66</td> </tr> </table>	1-24	25-49	50-99	100+	\$13.32	\$12.39	\$11.46	\$10.66
1-24	25-49	50-99	100+																																	
\$13.12	\$12.20	\$11.28	\$10.50																																	
1-24	25-49	50-99	100+																																	
\$11.86	\$11.03	\$10.20	\$9.49																																	
1-24	25-49	50-99	100+																																	
\$12.06	\$11.22	\$10.37	\$9.65																																	
1-24	25-49	50-99	100+																																	
\$13.32	\$12.39	\$11.46	\$10.66																																	
 <b>STACKING TIP PLUGS</b>	<p>Model No. PE9902</p> <table border="1"> <tr> <td>1-24</td> <td>25-49</td> <td>50-99</td> <td>100+</td> </tr> <tr> <td>\$15.55</td> <td>\$14.46</td> <td>\$13.37</td> <td>\$12.44</td> </tr> </table>	1-24	25-49	50-99	100+	\$15.55	\$14.46	\$13.37	\$12.44	<p>Model No. PE9911</p> <table border="1"> <tr> <td>1-24</td> <td>25-49</td> <td>50-99</td> <td>100+</td> </tr> <tr> <td>\$14.29</td> <td>\$13.29</td> <td>\$12.29</td> <td>\$11.43</td> </tr> </table>	1-24	25-49	50-99	100+	\$14.29	\$13.29	\$12.29	\$11.43	<p>Model No. PE9952</p> <table border="1"> <tr> <td>1-24</td> <td>25-49</td> <td>50-99</td> <td>100+</td> </tr> <tr> <td>\$14.54</td> <td>\$13.52</td> <td>\$12.50</td> <td>\$11.63</td> </tr> </table>	1-24	25-49	50-99	100+	\$14.54	\$13.52	\$12.50	\$11.63	<p>Model No. PE9961</p> <table border="1"> <tr> <td>1-24</td> <td>25-49</td> <td>50-99</td> <td>100+</td> </tr> <tr> <td>\$15.81</td> <td>\$14.70</td> <td>\$13.60</td> <td>\$12.65</td> </tr> </table>	1-24	25-49	50-99	100+	\$15.81	\$14.70	\$13.60	\$12.65
1-24	25-49	50-99	100+																																	
\$15.55	\$14.46	\$13.37	\$12.44																																	
1-24	25-49	50-99	100+																																	
\$14.29	\$13.29	\$12.29	\$11.43																																	
1-24	25-49	50-99	100+																																	
\$14.54	\$13.52	\$12.50	\$11.63																																	
1-24	25-49	50-99	100+																																	
\$15.81	\$14.70	\$13.60	\$12.65																																	
 <b>STANDARD STACKING BANANA PLUGS</b>	<p>Model No. PE9903</p> <table border="1"> <tr> <td>1-24</td> <td>25-49</td> <td>50-99</td> <td>100+</td> </tr> <tr> <td>\$14.29</td> <td>\$13.29</td> <td>\$12.29</td> <td>\$11.43</td> </tr> </table>	1-24	25-49	50-99	100+	\$14.29	\$13.29	\$12.29	\$11.43	<p>Model No. PE9912</p> <table border="1"> <tr> <td>1-24</td> <td>25-49</td> <td>50-99</td> <td>100+</td> </tr> <tr> <td>\$13.12</td> <td>\$12.20</td> <td>\$11.28</td> <td>\$10.50</td> </tr> </table>	1-24	25-49	50-99	100+	\$13.12	\$12.20	\$11.28	\$10.50	<p>Model No. PE9953</p> <table border="1"> <tr> <td>1-24</td> <td>25-49</td> <td>50-99</td> <td>100+</td> </tr> <tr> <td>\$13.32</td> <td>\$12.39</td> <td>\$11.46</td> <td>\$10.66</td> </tr> </table>	1-24	25-49	50-99	100+	\$13.32	\$12.39	\$11.46	\$10.66	<p>Model No. PE9962</p> <table border="1"> <tr> <td>1-24</td> <td>25-49</td> <td>50-99</td> <td>100+</td> </tr> <tr> <td>\$14.54</td> <td>\$13.52</td> <td>\$12.50</td> <td>\$11.63</td> </tr> </table>	1-24	25-49	50-99	100+	\$14.54	\$13.52	\$12.50	\$11.63
1-24	25-49	50-99	100+																																	
\$14.29	\$13.29	\$12.29	\$11.43																																	
1-24	25-49	50-99	100+																																	
\$13.12	\$12.20	\$11.28	\$10.50																																	
1-24	25-49	50-99	100+																																	
\$13.32	\$12.39	\$11.46	\$10.66																																	
1-24	25-49	50-99	100+																																	
\$14.54	\$13.52	\$12.50	\$11.63																																	
 <b>MINIATURE STACKING BANANA PLUGS</b>	<p>Model No. PE9904</p> <table border="1"> <tr> <td>1-24</td> <td>25-49</td> <td>50-99</td> <td>100+</td> </tr> <tr> <td>\$15.55</td> <td>\$14.46</td> <td>\$13.37</td> <td>\$12.44</td> </tr> </table>	1-24	25-49	50-99	100+	\$15.55	\$14.46	\$13.37	\$12.44	<p>Model No. PE9913</p> <table border="1"> <tr> <td>1-24</td> <td>25-49</td> <td>50-99</td> <td>100+</td> </tr> <tr> <td>\$14.29</td> <td>\$13.29</td> <td>\$12.29</td> <td>\$11.43</td> </tr> </table>	1-24	25-49	50-99	100+	\$14.29	\$13.29	\$12.29	\$11.43	<p>Model No. PE9954</p> <table border="1"> <tr> <td>1-24</td> <td>25-49</td> <td>50-99</td> <td>100+</td> </tr> <tr> <td>\$14.54</td> <td>\$13.52</td> <td>\$12.50</td> <td>\$11.63</td> </tr> </table>	1-24	25-49	50-99	100+	\$14.54	\$13.52	\$12.50	\$11.63	<p>Model No. PE9963</p> <table border="1"> <tr> <td>1-24</td> <td>25-49</td> <td>50-99</td> <td>100+</td> </tr> <tr> <td>\$15.81</td> <td>\$14.70</td> <td>\$13.60</td> <td>\$12.65</td> </tr> </table>	1-24	25-49	50-99	100+	\$15.81	\$14.70	\$13.60	\$12.65
1-24	25-49	50-99	100+																																	
\$15.55	\$14.46	\$13.37	\$12.44																																	
1-24	25-49	50-99	100+																																	
\$14.29	\$13.29	\$12.29	\$11.43																																	
1-24	25-49	50-99	100+																																	
\$14.54	\$13.52	\$12.50	\$11.63																																	
1-24	25-49	50-99	100+																																	
\$15.81	\$14.70	\$13.60	\$12.65																																	
 <b>SAFETY HOOKS</b>	<p>Model No. PE9905</p> <table border="1"> <tr> <td>1-24</td> <td>25-49</td> <td>50-99</td> <td>100+</td> </tr> <tr> <td>\$14.29</td> <td>\$13.29</td> <td>\$12.29</td> <td>\$11.43</td> </tr> </table>	1-24	25-49	50-99	100+	\$14.29	\$13.29	\$12.29	\$11.43	<p>Model No. PE9914</p> <table border="1"> <tr> <td>1-24</td> <td>25-49</td> <td>50-99</td> <td>100+</td> </tr> <tr> <td>\$13.12</td> <td>\$12.20</td> <td>\$11.28</td> <td>\$10.50</td> </tr> </table>	1-24	25-49	50-99	100+	\$13.12	\$12.20	\$11.28	\$10.50	<p>Model No. PE9955</p> <table border="1"> <tr> <td>1-24</td> <td>25-49</td> <td>50-99</td> <td>100+</td> </tr> <tr> <td>\$13.32</td> <td>\$12.39</td> <td>\$11.46</td> <td>\$10.66</td> </tr> </table>	1-24	25-49	50-99	100+	\$13.32	\$12.39	\$11.46	\$10.66	<p>Model No. PE9964</p> <table border="1"> <tr> <td>1-24</td> <td>25-49</td> <td>50-99</td> <td>100+</td> </tr> <tr> <td>\$14.54</td> <td>\$13.525</td> <td>\$12.50</td> <td>\$11.63</td> </tr> </table>	1-24	25-49	50-99	100+	\$14.54	\$13.525	\$12.50	\$11.63
1-24	25-49	50-99	100+																																	
\$14.29	\$13.29	\$12.29	\$11.43																																	
1-24	25-49	50-99	100+																																	
\$13.12	\$12.20	\$11.28	\$10.50																																	
1-24	25-49	50-99	100+																																	
\$13.32	\$12.39	\$11.46	\$10.66																																	
1-24	25-49	50-99	100+																																	
\$14.54	\$13.525	\$12.50	\$11.63																																	
 <b>#8 SPADE LUGS</b>	<p>Model No. PE9906</p> <table border="1"> <tr> <td>1-24</td> <td>25-49</td> <td>50-99</td> <td>100+</td> </tr> <tr> <td>\$11.86</td> <td>\$11.03</td> <td>\$10.20</td> <td>\$9.49</td> </tr> </table>	1-24	25-49	50-99	100+	\$11.86	\$11.03	\$10.20	\$9.49	<p>Model No. PE9915</p> <table border="1"> <tr> <td>1-24</td> <td>25-49</td> <td>50-99</td> <td>100+</td> </tr> <tr> <td>\$10.74</td> <td>\$9.99</td> <td>\$9.24</td> <td>\$8.59</td> </tr> </table>	1-24	25-49	50-99	100+	\$10.74	\$9.99	\$9.24	\$8.59	<p>Model No. PE9956</p> <table border="1"> <tr> <td>1-24</td> <td>25-49</td> <td>50-99</td> <td>100+</td> </tr> <tr> <td>\$10.94</td> <td>\$10.17</td> <td>\$9.41</td> <td>\$8.75</td> </tr> </table>	1-24	25-49	50-99	100+	\$10.94	\$10.17	\$9.41	\$8.75	<p>Model No. PE9965</p> <table border="1"> <tr> <td>1-24</td> <td>25-49</td> <td>50-99</td> <td>100+</td> </tr> <tr> <td>\$11.86</td> <td>\$11.03</td> <td>\$10.20</td> <td>\$9.49</td> </tr> </table>	1-24	25-49	50-99	100+	\$11.86	\$11.03	\$10.20	\$9.49
1-24	25-49	50-99	100+																																	
\$11.86	\$11.03	\$10.20	\$9.49																																	
1-24	25-49	50-99	100+																																	
\$10.74	\$9.99	\$9.24	\$8.59																																	
1-24	25-49	50-99	100+																																	
\$10.94	\$10.17	\$9.41	\$8.75																																	
1-24	25-49	50-99	100+																																	
\$11.86	\$11.03	\$10.20	\$9.49																																	
 <b>INSULATED SPADE LUGS</b>	<p>Model No. PE9907</p> <table border="1"> <tr> <td>1-24</td> <td>25-49</td> <td>50-99</td> <td>100+</td> </tr> <tr> <td>\$13.12</td> <td>\$12.20</td> <td>\$11.28</td> <td>\$10.50</td> </tr> </table>	1-24	25-49	50-99	100+	\$13.12	\$12.20	\$11.28	\$10.50	<p>Model No. PE9916</p> <table border="1"> <tr> <td>1-24</td> <td>25-49</td> <td>50-99</td> <td>100+</td> </tr> <tr> <td>\$11.86</td> <td>\$11.03</td> <td>\$10.20</td> <td>\$9.49</td> </tr> </table>	1-24	25-49	50-99	100+	\$11.86	\$11.03	\$10.20	\$9.49	<p>Model No. PE9957</p> <table border="1"> <tr> <td>1-24</td> <td>25-49</td> <td>50-99</td> <td>100+</td> </tr> <tr> <td>\$12.06</td> <td>\$11.22</td> <td>\$10.37</td> <td>\$9.65</td> </tr> </table>	1-24	25-49	50-99	100+	\$12.06	\$11.22	\$10.37	\$9.65	<p>Model No. PE9966</p> <table border="1"> <tr> <td>1-24</td> <td>25-49</td> <td>50-99</td> <td>100+</td> </tr> <tr> <td>\$13.12</td> <td>\$12.20</td> <td>\$11.28</td> <td>\$10.50</td> </tr> </table>	1-24	25-49	50-99	100+	\$13.12	\$12.20	\$11.28	\$10.50
1-24	25-49	50-99	100+																																	
\$13.12	\$12.20	\$11.28	\$10.50																																	
1-24	25-49	50-99	100+																																	
\$11.86	\$11.03	\$10.20	\$9.49																																	
1-24	25-49	50-99	100+																																	
\$12.06	\$11.22	\$10.37	\$9.65																																	
1-24	25-49	50-99	100+																																	
\$13.12	\$12.20	\$11.28	\$10.50																																	
 <b>UN-TERMINATED #20 AWG LEADS</b>	<p>Model No. PE9908</p> <table border="1"> <tr> <td>1-24</td> <td>25-49</td> <td>50-99</td> <td>100+</td> </tr> <tr> <td>\$10.12</td> <td>\$9.41</td> <td>\$8.70</td> <td>\$8.10</td> </tr> </table>	1-24	25-49	50-99	100+	\$10.12	\$9.41	\$8.70	\$8.10	<p>Model No. PE9917</p> <table border="1"> <tr> <td>1-24</td> <td>25-49</td> <td>50-99</td> <td>100+</td> </tr> <tr> <td>\$8.61</td> <td>\$8.01</td> <td>\$7.40</td> <td>\$6.89</td> </tr> </table>	1-24	25-49	50-99	100+	\$8.61	\$8.01	\$7.40	\$6.89	<p>Model No. PE9958</p> <table border="1"> <tr> <td>1-24</td> <td>25-49</td> <td>50-99</td> <td>100+</td> </tr> <tr> <td>\$8.77</td> <td>\$8.16</td> <td>\$7.54</td> <td>\$7.02</td> </tr> </table>	1-24	25-49	50-99	100+	\$8.77	\$8.16	\$7.54	\$7.02	<p>Model No. PE9967</p> <table border="1"> <tr> <td>1-24</td> <td>25-49</td> <td>50-99</td> <td>100+</td> </tr> <tr> <td>\$9.58</td> <td>\$8.91</td> <td>\$8.24</td> <td>\$7.66</td> </tr> </table>	1-24	25-49	50-99	100+	\$9.58	\$8.91	\$8.24	\$7.66
1-24	25-49	50-99	100+																																	
\$10.12	\$9.41	\$8.70	\$8.10																																	
1-24	25-49	50-99	100+																																	
\$8.61	\$8.01	\$7.40	\$6.89																																	
1-24	25-49	50-99	100+																																	
\$8.77	\$8.16	\$7.54	\$7.02																																	
1-24	25-49	50-99	100+																																	
\$9.58	\$8.91	\$8.24	\$7.66																																	

# CONNECTOR FREQUENCY RANGE CHART

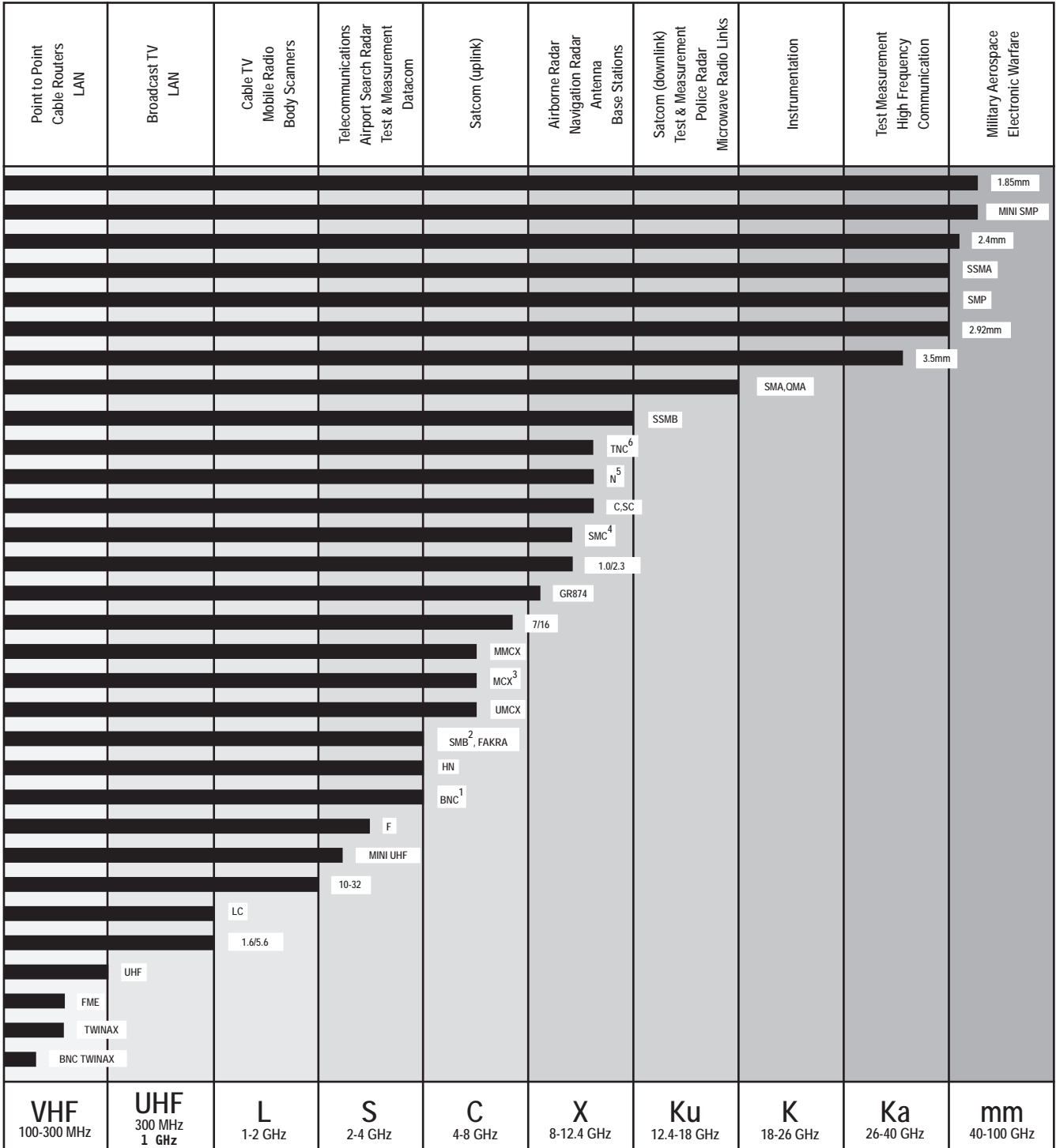

Connectors

See Our Website For Real-Time Stock Availability!

**Notes:**

- 1: BNC-75 Ohm connectors operate up to 1 GHz
- 2: SMB-75 Ohm & Mini SMB-75 Ohm connectors operate up to 4 GHz
- 3: MCX-75 Ohm connectors operate up to 6 GHz
- 4: SMC-75 Ohm connectors operate up to 10 GHz
- 5: N-75 Ohm connectors operate up to 1.5 GHz
- 6: TNC-75 Ohm connectors operate up to 1 GHz

# Connector Selection Guide

## 3 Easy Ways to Find your Product.....

### 1. Search by PE Part Number

If you know the PE part number you are searching for, please reference our Part Number Index on Page 253.

### 2. Quick Reference Guide

(Page number refers to first appearance of product in the Connector Section)

Connector Series	Page	Connector Series	Page	Connector Series	Page	Connector Series	Page
1.0/2.3	116	75 Ohm MINI SMB	132	GR874	119	RCA	134
1.85mm	92	75 Ohm N	125	HN	107	SC	106
10-32	106	75 Ohm SMB	130	LC	107	SHV	124
2.4mm	92	75 Ohm SMC	127	MC-CARD	117	SMA	83
2.92mm	91	75 Ohm TNC	126	MCX	111	SMB	112
3.5mm	90	Banana Plug	135	MHV	123	SMC	104
3/4"-20 Twinax	134	BNC	119	MINI SMP	110	SMP	109
7/16 DIN	101	BNC Twinax	135	MINI UHF	103	SSMA	93
75 Ohm 1.6/5.6	129	C	124	MMCX	110	SSMB	114
75 Ohm BNC	132	D-Sub Contacts	117	N	94	TNC	98
75 Ohm F	128	FAKRA	115	QMA	108	UHF	102
75 Ohm MCX	130	FME	104	QN	109	UMCX	110

Connectors

### 3. Connector Locator

Connector Type	Page
<b>1.0/2.3 Jack Connectors</b>	
Straight, Bulkhead Mount, Cable Connectors	116
Right Angle, Bulkhead Mount, Cable Connectors	116
Straight, PCB Mount	117
Straight, Bulkhead Mount, PCB Mount	117
Right Angle, PCB Mount	117
<b>1.0/2.3 Plug Connectors</b>	
Straight, Cable Connectors	116
Right Angle, Cable Connectors	116
<b>1.85mm Female Connectors</b>	
Straight, Threaded Mount, Field Replaceable	92
Straight, Panel Mount, Field Replaceable	93
<b>1.85mm Male Connectors</b>	
Straight, Cable Connectors	92
Straight, Threaded Mount, Field Replaceable	92
<b>10-32 Female Connectors</b>	
Straight, Cable Connectors	106
Straight, Bulkhead Mount, Cable Connectors	106
Straight, Bulkhead Mount, Terminal	106
Straight, PCB Mount	106
Right Angle, PCB Mount	106
<b>10-32 Male Connectors</b>	
Straight, Cable Connectors	106
Right Angle, Cable Connectors	106

Connector Type	Page
<b>2.4mm Female Connectors</b>	
Straight, Cable Connectors	92
Straight, Bulkhead Mount, Cable Connectors	92
Straight, Panel Mount, Terminal	92
Straight, Threaded Mount, Field Replaceable	92
<b>2.4mm Male Connectors</b>	
Straight, Cable Connectors	92
Straight, Panel Mount, Terminal	92
Straight, Threaded Mount, Field Replaceable	92
<b>2.92mm Female Connectors</b>	
Straight, Cable Connectors	91
Straight, Bulkhead Mount, Cable Connectors	91
Straight, Threaded Mount, Field Replaceable	91
Straight, Panel Mount, Field Replaceable	91
<b>2.92mm Male Connectors</b>	
Straight, Cable Connectors	91
Straight, Panel Mount, Terminal	91
Straight, Threaded Mount, Field Replaceable	91
Straight, Panel Mount, Field Replaceable	91
<b>3.5mm Female Connectors</b>	
Straight, Cable Connectors	91
Straight, Bulkhead Mount, Cable Connectors	91
<b>3.5mm Male Connectors</b>	
Straight, Cable Connectors	90

See Our Website For Real-Time Stock Availability!

# Connector Locator

Connector Type	Page
<b>3/4"-20 Threaded Twinax Female Connectors</b>	
Straight, Cable Connectors	134
Straight, Bulkhead Mount, Terminal	134
Straight, Panel Mount, Terminal	134
<b>3/4"-20 Threaded Twinax Male Connectors</b>	
Straight, Cable Connectors	134
<b>7/16 DIN Female Connectors</b>	
Straight, Cable Connectors	101
Straight, Bulkhead Mount, Cable Connectors	102
Straight, Panel Mount, Cable Connectors	102
Straight, Bulkhead Mount, Terminal	102
Straight, Panel Mount, Terminal	102
<b>7/16 DIN Male Connectors</b>	
Straight, Cable Connectors	101
Right Angle, Cable Connectors	101
<b>75 Ohm 1.6/5.6 Jack Connectors</b>	
Straight, Bulkhead Mount, Cable Connectors	129
Right Angle, Bulkhead Mount, Cable Connectors	129
Straight, Bulkhead Mount, PCB Mount	129
Right Angle, PCB Mount	129
<b>75 Ohm 1.6/5.6 Plug Connectors</b>	
Straight, Cable Connectors	129
Right Angle, Cable Connectors	129
<b>75 Ohm BNC Female Connectors</b>	
Straight, Cable Connectors	133
Straight, Bulkhead Mount, Cable Connectors	133
Straight, Panel Mount, Cable Connectors	133
Straight, Bulkhead Mount, Terminal	133
Right Angle, Bulkhead Mount, Terminal	133
Straight, Panel Mount, Terminal	134
Right Angle, Panel Mount, Terminal	134
Straight, PCB Mount	134
Straight, Bulkhead Mount, PCB Mount	134
<b>75 Ohm BNC Male Connectors</b>	
Straight, Cable Connectors	132
Right Angle, Cable Connectors	133
Straight, Bulkhead Mount, Terminal	133
Straight, Panel Mount, Terminal	133
<b>75 Ohm F Female Connectors</b>	
Straight, Bulkhead Mount, Cable Connectors	128
Straight, Bulkhead Mount, Terminal	128
Straight, Panel Mount, Terminal	128
Straight, PCB Mount	129
Right Angle, PCB Mount	129
Straight, Bulkhead Mount, PCB Mount	129
Right Angle, Bulkhead Mount, PCB Mount	129
<b>75 Ohm F Male Connectors</b>	
Straight, Cable Connectors	128
Right Angle, Cable Connectors	128
<b>75 Ohm MCX Jack Connectors</b>	
Straight, Cable Connectors	130
Straight, Bulkhead Mount, Cable Connectors	130
Straight, Bulkhead Mount, Terminal	130
Straight, PCB Mount	130
Right Angle, PCB Mount	130

Connector Type	Page
<b>75 Ohm MCX Plug Connectors</b>	
Straight, Cable Connectors	130
Right Angle, Cable Connectors	130
Straight, PCB Mount	130
<b>75 Ohm MINI SMB Jack Connectors</b>	
Straight, Cable Connectors	132
Straight, Panel Mount, Terminal	132
Straight, PCB Mount	132
Right Angle, PCB Mount	132
Straight, Bulkhead Mount, PCB Mount	132
Right Angle, Bulkhead Mount, PCB Mount	132
<b>75 Ohm MINI SMB Plug Connectors</b>	
Straight, Cable Connectors	132
Right Angle, Cable Connectors	132
<b>75 Ohm N Female Connectors</b>	
Straight, Cable Connectors	126
Straight, Bulkhead Mount, Terminal	126
Straight, Panel Mount, Terminal	126
<b>75 Ohm N Male Connectors</b>	
Straight, Cable Connectors	125
Right Angle, Cable Connectors	126
Straight, Panel Mount, Terminal	126
<b>75 Ohm SMB Jack Connectors</b>	
Straight, Cable Connectors	131
Straight, Bulkhead Mount, Cable Connectors	131
Straight, Terminal	131
Straight, Bulkhead Mount, Terminal	131
Right Angle, Bulkhead Mount, Terminal	131
Right Angle, PCB Mount	131
<b>75 Ohm SMB Plug Connectors</b>	
Straight, Cable Connectors	130
Right Angle, Cable Connectors	131
Straight, Bulkhead Mount, Terminal	131
Straight, PCB Mount	131
Right Angle, PCB Mount	131
<b>75 Ohm SMC Jack Connectors</b>	
Straight, Cable Connectors	127
Straight, Bulkhead Mount, Cable Connectors	127
Straight, Bulkhead Mount, Terminal	127
Right Angle, Bulkhead Mount, Terminal	127
Straight, PCB Mount	128
Right Angle, PCB Mount	128
<b>75 Ohm SMC Plug Connectors</b>	
Straight, Cable Connectors	127
Right Angle, Cable Connectors	127
Straight, Bulkhead Mount, Terminal	127
Straight, PCB Mount	127
Right Angle, PCB Mount	127
<b>75 Ohm TNC Female Connectors</b>	
Straight, Bulkhead Mount, Cable Connectors	126
Straight, Bulkhead Mount, Terminal	126
Straight, Panel Mount, Terminal	126
<b>75 Ohm TNC Male Connectors</b>	
Straight, Cable Connectors	126
Right Angle, Cable Connectors	126



# Connector Locator

Connector Type	Page
<b>Banana Plug Plug Connectors</b>	
Straight, Cable Connectors	135
<b>BNC Female Connectors</b>	
Straight, Cable Connectors	120
Straight, Bulkhead Mount, Cable Connectors	120
Straight, Panel Mount, Cable Connectors	120
Reverse Polarity Straight, Cable Connectors	121
Reverse Polarity Straight, Bulkhead Mount, Cable Connectors	121
Reverse Polarity Straight, Panel Mount, Cable Connectors	121
Straight, Bulkhead Mount, Terminal	121
Right Angle, Bulkhead Mount, Terminal	122
Straight, Panel Mount, Terminal	122
Right Angle, Panel Mount, Terminal	122
Reverse Polarity Straight, Bulkhead Mount, Terminal	122
Reverse Polarity Right Angle, Bulkhead Mount, Terminal	122
Reverse Polarity Straight, Panel Mount, Terminal	122
Reverse Polarity Right Angle, Panel Mount, Terminal	122
Straight, PCB Mount	122
Straight, Bulkhead Mount, PCB Mount	122
<b>BNC Male Connectors</b>	
Straight, Cable Connectors	119
Right Angle, Cable Connectors	119
Reverse Polarity Straight, Cable Connectors	120
Reverse Polarity Right Angle, Cable Connectors	121
Straight, Bulkhead Mount, Terminal	121
Straight, Panel Mount, Terminal	121
Reverse Polarity Straight, Bulkhead Mount, Terminal	122
Reverse Polarity Straight, Panel Mount, Terminal	122
<b>BNC Twinax Jack Connectors</b>	
Straight, Cable Connectors	135
Straight, Bulkhead Mount, Cable Connectors	135
Straight, Bulkhead Mount, Terminal	135
Straight, Panel Mount, Terminal	135
Straight, PCB Mount	136
Right Angle, PCB Mount	136
<b>BNC Twinax Plug Connectors</b>	
Straight, Cable Connectors	135
<b>C Female Connectors</b>	
Straight, Cable Connectors	125
Straight, Bulkhead Mount, Cable Connectors	125
Straight, Panel Mount, Cable Connectors	125
Straight, Bulkhead Mount, Terminal	125
Straight, Panel Mount, Terminal	125
<b>C Male Connectors</b>	
Straight, Cable Connectors	124
Right Angle, Cable Connectors	124
Straight, Bulkhead Mount, Terminal	125
Straight, Panel Mount, Terminal	125
<b>D-Sub Contacts Plug Connectors</b>	
Straight, Cable Connectors	117
Right Angle, Cable Connectors	117
Straight, PCB Mount	118
Right Angle, PCB Mount	118
<b>D-Sub Contacts Receptacle Connectors</b>	
Straight, Cable Connectors	118

Connector Type	Page
Right Angle, Cable Connectors	118
Straight, PCB Mount	118
Right Angle, PCB Mount	118
<b>FAKRA Jack Connectors</b>	
Straight, Cable Connectors	115
Right Angle, Cable Connectors	115
Right Angle, PCB Mount	116
<b>FAKRA Plug Connectors</b>	
Straight, Cable Connectors	115
Straight, PCB Mount	115
Right Angle, PCB Mount	116
<b>FME Jack Connectors</b>	
Straight, Cable Connectors	104
<b>FME Plug Connectors</b>	
Straight, Cable Connectors	104
Straight, Bulkhead Mount, Terminal	104
<b>GR874 Sexless Connectors</b>	
Straight, Cable Connectors	119
Straight	119
<b>HN Female Connectors</b>	
Straight, Cable Connectors	108
Straight, Bulkhead Mount, Terminal	108
Straight, Panel Mount, Terminal	108
<b>HN Male Connectors</b>	
Straight, Cable Connectors	107
Right Angle, Cable Connectors	108
<b>LC Female Connectors</b>	
Straight, Cable Connectors	107
Straight, Panel Mount, Terminal	107
<b>LC Male Connectors</b>	
Straight, Cable Connectors	107
Right Angle, Cable Connectors	107
<b>MC-CARD Plug Connectors</b>	
Straight, Cable Connectors	117
Right Angle, Cable Connectors	117
<b>MCX Jack Connectors</b>	
Straight, Cable Connectors	111
Straight, Bulkhead Mount, Cable Connectors	111
Reverse Polarity Straight, Bulkhead Mount, Cable Connectors	111
Straight, Bulkhead Mount, Terminal	112
Right Angle, Bulkhead Mount, Terminal	112
Straight, Panel Mount, Terminal	112
Straight, PCB Mount	112
Right Angle, PCB Mount	112
Reverse Polarity Straight, PCB Mount	112
Reverse Polarity Straight, Bulkhead Mount, PCB Mount	112
Reverse Polarity Right Angle, Bulkhead Mount, PCB Mount	112
<b>MCX Plug Connectors</b>	
Straight, Cable Connectors	111
Right Angle, Cable Connectors	111
Reverse Polarity Straight, Cable Connectors	111
Reverse Polarity Right Angle, Cable Connectors	111
Straight, PCB Mount	112
<b>MHV Female Connectors</b>	

# Connector Locator

Connector Type	Page
Straight, Cable Connectors	123
Straight, Bulkhead Mount, Cable Connectors	123
Straight, Panel Mount, Cable Connectors	123
Straight, Bulkhead Mount, Terminal	123
Straight, Panel Mount, Terminal	123
<b>MHV Male Connectors</b>	
Straight, Cable Connectors	123
Right Angle, Cable Connectors	123
<b>MINI SMP Female Connectors</b>	
Straight, Cable Connectors	110
Right Angle, Cable Connectors	110
<b>MINI SMP Male Connectors</b>	
Straight, PCB Mount	110
<b>MINI UHF Female Connectors</b>	
Straight, Cable Connectors	103
Straight, Bulkhead Mount, Cable Connectors	103
Straight, Bulkhead Mount, Terminal	103
Straight, Panel Mount, Terminal	103
Straight, Bulkhead Mount, PCB Mount	103
<b>MINI UHF Male Connectors</b>	
Straight, Cable Connectors	103
Right Angle, Cable Connectors	103
<b>MMCX Jack Connectors</b>	
Straight, Cable Connectors	110
Straight, PCB Mount	111
Right Angle, PCB Mount	111
<b>MMCX Plug Connectors</b>	
Straight, Cable Connectors	110
Right Angle, Cable Connectors	110
Straight, PCB Mount	110
<b>N Female Connectors</b>	
Straight, Cable Connectors	95
Straight, Bulkhead Mount, Cable Connectors	96
Straight, Panel Mount, Cable Connectors	96
Reverse Polarity Straight, Cable Connectors	97
Straight, Bulkhead Mount, Terminal	97
Straight, Panel Mount, Terminal	97
Right Angle, Panel Mount, Terminal	97
Straight, Press In Mount, Terminal	97
Straight, PCB Mount	97
Straight, Bulkhead Mount, PCB Mount	98
Right Angle, Bulkhead Mount, PCB Mount	98
<b>N Male Connectors</b>	
Straight, Cable Connectors	94
Right Angle, Cable Connectors	95
Reverse Polarity Straight, Cable Connectors	97
Straight, Bulkhead Mount, Terminal	97
Straight, Panel Mount, Terminal	97
<b>QMA Female Connectors</b>	
Straight, Bulkhead Mount, Cable Connectors	108
Straight, PCB Mount	108
Right Angle, PCB Mount	108
<b>QMA Male Connectors</b>	
Straight, Cable Connectors	108
Right Angle, Cable Connectors	108

Connector Type	Page
<b>QN Female Connectors</b>	
Straight, Bulkhead Mount, Cable Connectors	109
Straight, Panel Mount, Terminal	109
<b>QN Male Connectors</b>	
Straight, Cable Connectors	109
Right Angle, Cable Connectors	109
<b>RCA Jack Connectors</b>	
Straight, Bulkhead Mount, Cable Connectors	135
<b>RCA Plug Connectors</b>	
Straight, Cable Connectors	134
Right Angle, Cable Connectors	135
<b>SC Female Connectors</b>	
Straight, Bulkhead Mount, Terminal	107
Straight, Panel Mount, Terminal	107
<b>SC Male Connectors</b>	
Straight, Cable Connectors	106
Right Angle, Cable Connectors	107
<b>SHV Jack Connectors</b>	
Straight, Bulkhead Mount, Cable Connectors	124
Straight, Bulkhead Mount, Terminal	124
Straight, Panel Mount, Terminal	124
<b>SHV Plug Connectors</b>	
Straight, Cable Connectors	124
Straight, Bulkhead Mount, Terminal	124
<b>SMA Female Connectors</b>	
Straight, Cable Connectors	84
Straight, Bulkhead Mount, Cable Connectors	84
Straight, Panel Mount, Cable Connectors	84
Reverse Polarity Straight, Cable Connectors	85
Reverse Polarity Straight, Bulkhead Mount, Cable Connectors	85
Reverse Thread Straight, Cable Connectors	86
Reverse Thread Straight, Bulkhead Mount, Cable Connectors	86
Straight, PCB Mount, Terminal	86
Right Angle, PCB Mount, Terminal	86
Straight, Bulkhead Mount, Terminal	87
Right Angle, Bulkhead Mount, Terminal	87
Straight, Panel Mount, Terminal	87
Right Angle, Panel Mount, Terminal	87
Straight, Press In Mount, Terminal	88
Reverse Polarity Straight, Bulkhead Mount, Terminal	88
Reverse Polarity Straight, Panel Mount, Terminal	88
Reverse Thread Straight, PCB Mount, Terminal	88
Reverse Thread Right Angle, PCB Mount, Terminal	88
Reverse Thread Straight, Panel Mount, Terminal	88
Straight, PCB Mount	88
Right Angle, PCB Mount	88
Straight, Bulkhead Mount, PCB Mount	89
Right Angle, Bulkhead Mount, PCB Mount	89
Reverse Polarity Straight, PCB Mount	89
Reverse Polarity Right Angle, PCB Mount	89
Reverse Polarity Straight, Bulkhead Mount, PCB Mount	89
Reverse Polarity Right Angle, Bulkhead Mount, PCB Mount	89
Reverse Thread Straight, PCB Mount	89
Straight, Panel Mount, Field Replaceable	90
Right Angle, Panel Mount, Field Replaceable	90

# Connector Locator

Connector Type	Page
<b>SMA Male Connectors</b>	
Straight, Cable Connectors	83
Right Angle, Cable Connectors	83
Reverse Polarity Straight, Cable Connectors	85
Reverse Polarity Right Angle, Cable Connectors	85
Reverse Thread Straight, Cable Connectors	86
Reverse Thread Right Angle, Cable Connectors	86
Straight, Bulkhead Mount, Terminal	86
Straight, Panel Mount, Terminal	86
Straight, PCB Mount	88
Right Angle, PCB Mount	88
Reverse Polarity Straight, PCB Mount	89
Straight, Panel Mount, Field Replaceable	90
<b>SMB Jack Connectors</b>	
Straight, Cable Connectors	113
Straight, Bulkhead Mount, Cable Connectors	113
Straight, Bulkhead Mount, Terminal	113
Right Angle, Bulkhead Mount, Terminal	113
Straight, Panel Mount, Terminal	113
Straight, PCB Mount	114
Right Angle, PCB Mount	114
Straight, PCB Mount	114
Right Angle, PCB Mount	114
Straight, Bulkhead Mount, PCB Mount	114
Right Angle, Bulkhead Mount, PCB Mount	114
<b>SMB Plug Connectors</b>	
Straight, Cable Connectors	112
Right Angle, Cable Connectors	113
Straight, Bulkhead Mount, Terminal	113
Straight, PCB Mount	113
Right Angle, PCB Mount	113
<b>SMC Jack Connectors</b>	
Straight, Cable Connectors	104
Straight, Bulkhead Mount, Cable Connectors	104
Straight, Bulkhead Mount, Terminal	105
Right Angle, Bulkhead Mount, Terminal	105
Straight, Panel Mount, Terminal	105
Straight, PCB Mount	105
Right Angle, PCB Mount	105
Right Angle, Bulkhead Mount, PCB Mount	105
Right Angle, PCB Mount	105
Straight, Bulkhead Mount, PCB Mount	105
<b>SMC Plug Connectors</b>	
Straight, Cable Connectors	104
Right Angle, Cable Connectors	104
Straight, Bulkhead Mount, Terminal	105
Straight, PCB Mount	105
Right Angle, PCB Mount	105
<b>SMP Female Connectors</b>	
Straight, Cable Connectors	109
Right Angle, Cable Connectors	109
<b>SMP Male Connectors</b>	
Straight, Bulkhead Mount, Cable Connectors	109
Straight, PCB Mount	109
<b>SSMA Female Connectors</b>	

Connector Type	Page
Straight, Cable Connectors	93
Straight, Bulkhead Mount, Cable Connectors	93
Straight, Panel Mount, Cable Connectors	94
Straight, Bulkhead Mount, Terminal	94
Straight, Panel Mount, Terminal	94
Straight, PCB Mount	94
Right Angle, PCB Mount	94
<b>SSMA Male Connectors</b>	
Straight, Cable Connectors	93
Right Angle, Cable Connectors	93
Straight, Panel Mount, Terminal	94
Straight, PCB Mount	94
<b>SSMB Jack Connectors</b>	
Straight, Bulkhead Mount, Cable Connectors	114
Straight, Bulkhead Mount, Terminal	114
Straight, Panel Mount, Terminal	114
Straight, PCB Mount	115
Right Angle, PCB Mount	115
<b>SSMB Plug Connectors</b>	
Straight, Cable Connectors	114
Right Angle, Cable Connectors	114
<b>TNC Female Connectors</b>	
Straight, Cable Connectors	98
Straight, Bulkhead Mount, Cable Connectors	99
Straight, Panel Mount, Cable Connectors	99
Reverse Polarity Straight, Cable Connectors	99
Reverse Polarity Straight, Bulkhead Mount, Cable Connectors	100
Straight, Bulkhead Mount, Terminal	100
Right Angle, Bulkhead Mount, Terminal	100
Straight, Panel Mount, Terminal	100
Reverse Polarity Straight, Bulkhead Mount, Terminal	100
Reverse Polarity Straight, Panel Mount, Terminal	100
Right Angle, PCB Mount	101
<b>TNC Male Connectors</b>	
Straight, Cable Connectors	98
Right Angle, Cable Connectors	98
Reverse Polarity Straight, Cable Connectors	99
Reverse Polarity Right Angle, Cable Connectors	99
Straight, Panel Mount, Terminal	100
Reverse Polarity Straight, Panel Mount, Terminal	100
<b>UHF Female Connectors</b>	
Straight, Cable Connectors	102
Straight, Bulkhead Mount, Terminal	103
Straight, Panel Mount, Terminal	103
<b>UHF Male Connectors</b>	
Straight, Cable Connectors	102
<b>UHF Sexless Connectors</b>	
Straight, Accessories, Cable Connectors	103
<b>UMCX Jack Connectors</b>	
Straight, PCB Mount	110

# SMA Connectors

Product Image	Attachment Cable/Contact	Coax Type / Termination Type	Model No.	Price				Row		
				1-24	25-49	50-99	100 +			
<b>Male Straight, Cable Connectors</b>										
	Crimp/Solder	RG8X, PE-C240	PE44637	\$15.05	\$14.00	\$12.94	\$12.04	1		
		RG188-DS, RG316-DS	PE4401	\$11.50	\$10.70	\$9.89	\$9.20	2		
		PE-C400	PE44668	\$20.42	\$18.99	\$17.56	\$16.34	3		
		PE-P195	PE44203	\$10.99	\$10.22	\$9.45	\$8.79	4		
		RG174, RG316, RG188	PE4003	\$12.26	\$11.40	\$10.54	\$9.81	5		
		RG178, RG196	PE4398	\$14.54	\$13.52	\$12.50	\$11.63	6		
		RG180, RG195	PE4578	\$17.63	\$16.40	\$15.16	\$14.10	7		
		RG58	PE4215	\$8.92	\$8.30	\$7.67	\$7.14	8		
		RG58, RG141, RG303, Quick Disconnect	PE44460	\$49.91	\$46.42	\$42.92	\$39.93	9		
		RG59, RG62	PE4294	\$20.06	\$18.66	\$17.25	\$16.05	10		
		RG55, RG142, RG223, RG400	PE4008	\$9.88	\$9.19	\$8.50	\$7.90	11		
	Crimp/Solder (Captive Contact)	RG174, RG316, RG188	PE4589	\$13.22	\$12.29	\$11.37	\$10.58	12		
		RG58	PE4577	\$16.65	\$15.48	\$14.32	\$13.32	13		
	Clamp/Solder	RG55, RG142, RG223, RG400	PE4576	\$18.62	\$17.32	\$16.01	\$14.90	14		
		RG188-DS, RG316-DS	PE4400	\$22.44	\$20.87	\$19.30	\$17.95	15		
	Clamp/Solder	PE-P195	PE4085	\$18.59	\$17.29	\$15.99	\$14.87	16		
		PE-SR401AL, PE-SR401FL, RG401, .250" Semi-Rigid	PE4403	\$33.60	\$31.25	\$28.90	\$26.88	17		
		RG174, RG316, RG188	PE4026	\$20.35	\$18.93	\$17.50	\$16.28	18		
		RG178, RG196	PE4214	\$36.99	\$34.40	\$31.81	\$29.59	19		
		RG180, RG195	PE4399	\$16.16	\$15.03	\$13.90	\$12.93	20		
		RG213, RG214, RG8, RG9, RG225, RG393, RG11	PE4332	\$59.18	\$55.04	\$50.89	\$47.34	21		
		RG58, RG55, RG142, RG223, RG400	PE4027	\$20.67	\$19.22	\$17.78	\$16.54	22		
		RG188-DS, RG316-DS	PE4402	\$11.70	\$10.88	\$10.06	\$9.36	23		
		PE-020SR, .020" Semi-Rigid	PE4918	\$31.92	\$29.69	\$27.45	\$25.54	24		
		PE-034SR, .034" Semi-Rigid	PE4917	\$39.72	\$36.94	\$34.16	\$31.78	25		
	Solder/Solder	PE-047SR, PE-SR047AL, PE-SR047FL, .047" Semi-Rigid	PE4404	\$20.19	\$18.78	\$17.36	\$16.15	26		
		PE-SR401AL, PE-SR401FL, RG401, .250" Semi-Rigid	PE4907	\$35.26	\$32.79	\$30.32	\$28.21	27		
		PE-SR402AL, PE-SR402FL, RG402, .141" Semi-Rigid	PE4112	\$7.50	\$6.98	\$6.45	\$6.00	28		
		PE-SR405AL, PE-SR405FL, RG405, .085" Semi-Rigid	PE4005	\$6.71	\$6.24	\$5.77	\$5.37	29		
		RG174, RG316, RG188	PE4036	\$10.28	\$9.56	\$8.84	\$8.22	30		
		RG178, RG196	PE4213	\$14.10	\$13.11	\$12.13	\$11.28	31		
		RG58, RG55, RG142, RG223, RG400	PE4037	\$12.00	\$11.16	\$10.32	\$9.60	32		
			Solder (Without Contact)	PE-SR402AL, PE-SR402FL, RG402, .141" Semi-Rigid	PE4007	\$6.45	\$6.00	\$5.55	\$5.16	33
				RG174, RG316, RG188	PE4590	\$12.95	\$12.04	\$11.14	\$10.36	34
			Solder/Solder (Captive Contact)	RG58, RG55, RG142, RG223, RG400	PE4587	\$13.65	\$12.69	\$11.74	\$10.92	35
<b>Male Right Angle, Cable Connectors</b>										
	Crimp/Solder	RG8X, PE-C240	PE44638	\$23.61	\$21.96	\$20.30	\$18.89	36		
		RG188-DS, RG316-DS	PE4408	\$16.97	\$15.78	\$14.59	\$13.58	37		
		RG178, RG196	PE4296	\$20.82	\$19.36	\$17.91	\$16.66	38		
		RG180, RG195	PE4580	\$18.39	\$17.10	\$15.82	\$14.71	39		
		RG316, RG174, RG188	PE4009	\$14.69	\$13.66	\$12.63	\$11.75	40		
		RG58	PE4405	\$14.54	\$13.52	\$12.50	\$11.63	41		
		RG59, RG62	PE4327	\$24.57	\$22.85	\$21.13	\$19.66	42		
		RG55, RG142, RG223, RG400	PE4002	\$14.69	\$13.66	\$12.63	\$11.75	43		
			Clamp/Solder	RG188-DS, RG316-DS	PE4407	\$23.41	\$21.77	\$20.13	\$18.73	44
				RG178, RG196	PE4108	\$15.60	\$14.51	\$13.42	\$12.48	45
RG180, RG195	PE4579			\$19.40	\$18.04	\$16.68	\$15.52	46		
RG316, RG174, RG188	PE4028			\$23.66	\$22.00	\$20.35	\$18.93	47		
RG58, RG55, RG142, RG223, RG400	PE4029			\$20.87	\$19.41	\$17.95	\$16.70	48		
	Solder/Solder	RG188-DS, RG316-DS	PE4409	\$16.45	\$15.30	\$14.15	\$13.16	49		
		PE-020SR, .020" Semi-Rigid	PE4920	\$46.05	\$42.83	\$39.60	\$36.84	50		
		PE-034SR, .034" Semi-Rigid	PE4919	\$41.14	\$38.26	\$35.38	\$32.91	51		
		PE-047SR, PE-SR047AL, PE-SR047FL, .047" Semi-Rigid	PE4410	\$45.35	\$42.18	\$39.00	\$36.28	52		
		PE-SR401AL, PE-SR401FL, RG401, .250" Semi-Rigid	PE4932	\$41.80	\$38.87	\$35.95	\$33.44	53		
		PE-SR402AL, PE-SR402FL, RG402, .141" Semi-Rigid	PE4083	\$21.61	\$20.10	\$18.58	\$17.29	54		
		PE-SR405AL, PE-SR405FL, RG405, .085" Semi-Rigid	PE4025	\$22.14	\$20.59	\$19.04	\$17.71	55		
		RG178, RG196	PE4406	\$18.80	\$17.48	\$16.17	\$15.04	56		

Connectors

See Our Website For Real-Time Stock Availability!



# SMA Connectors

Connectors





See Our Website For Real-Time Stock Availability!

Product Image	Attachment Cable/Contact	Coax Type / Termination Type	Model No.	Price				Row
				1-24	25-49	50-99	100 +	
	Solder/Solder	RG316, RG174, RG188	PE4038	\$14.10	\$13.11	\$12.13	\$11.28	1
		RG58, RG55, RG142, RG223, RG400	PE4039	\$14.10	\$13.11	\$12.13	\$11.28	2

## Female Straight, Cable Connectors

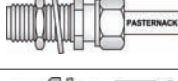
	Crimp/Solder	RG8X, PE-C240	PE44639	\$17.12	\$15.92	\$14.72	\$13.70	3
		RG188-DS, RG316-DS	PE4416	\$14.75	\$13.72	\$12.69	\$11.80	4
		PE-C400	PE44669	\$34.35	\$31.95	\$29.54	\$27.48	5
		RG178, RG196	PE4325	\$20.67	\$19.22	\$17.78	\$16.54	6
		RG316, RG174, RG188	PE4414	\$15.89	\$14.78	\$13.67	\$12.71	7
		RG58	PE4413	\$14.75	\$13.72	\$12.69	\$11.80	8
	Clamp/Solder	RG59, RG62	PE4326	\$21.58	\$20.07	\$18.56	\$17.26	9
		RG55, RG142, RG223, RG400	PE4412	\$12.16	\$11.31	\$10.46	\$9.73	10
		RG188-DS, RG316-DS	PE4415	\$22.34	\$20.78	\$19.21	\$17.87	11
		RG178, RG196	PE4591	\$22.34	\$20.78	\$19.21	\$17.87	12
		RG213, RG214, RG8, RG9, RG225, RG393, RG11	PE4411	\$43.52	\$40.47	\$37.43	\$34.82	13
		RG316, RG174, RG188	PE4030	\$22.34	\$20.78	\$19.21	\$17.87	14
		RG58, RG55, RG142, RG223, RG400	PE4031	\$31.11	\$28.93	\$26.75	\$24.89	15
		RG188-DS, RG316-DS	PE4417	\$12.95	\$12.04	\$11.14	\$10.36	16
		PE-020SR, .020" Semi-Rigid	PE4922	\$45.24	\$42.07	\$38.91	\$36.19	17
		PE-034SR, .034" Semi-Rigid	PE4921	\$41.14	\$38.26	\$35.38	\$32.91	18
	Solder/Solder	PE-047SR, PE-SR047AL, PE-SR047FL, .047" Semi-Rigid	PE4418	\$26.75	\$24.88	\$23.01	\$21.40	19
		PE-SR401AL, PE-SR401FL, RG401, .250" Semi-Rigid	PE4930	\$20.52	\$19.08	\$17.65	\$16.42	20
		PE-SR402AL, PE-SR402FL, RG402, .141" Semi-Rigid	PE4115	\$10.80	\$10.04	\$9.29	\$8.64	21
		PE-SR405AL, PE-SR405FL, RG405, .085" Semi-Rigid	PE4116	\$17.78	\$16.54	\$15.29	\$14.22	22
		RG178, RG196	PE4592	\$17.65	\$16.41	\$15.18	\$14.12	23
		RG316, RG174, RG188	PE4040	\$11.70	\$10.88	\$10.06	\$9.36	24
		RG58, RG55, RG142, RG223, RG400	PE4041	\$11.70	\$10.88	\$10.06	\$9.36	25

## Female Straight, Bulkhead Mount, Cable Connectors

	Crimp/Solder	RG188-DS, RG316-DS, B02 Mounting Hole	PE4425	\$17.05	\$15.86	\$14.66	\$13.64	26		
		RG178, RG196, w/o-ring, B02 Mounting Hole	PE44657	\$12.87	\$11.97	\$11.07	\$10.30	27		
		RG178, RG196, B02 Mounting Hole	PE4422	\$20.87	\$19.41	\$17.95	\$16.70	28		
		RG316, RG174, RG188, B02 Mounting Hole	PE4427	\$15.20	\$14.14	\$13.07	\$12.16	29		
		RG58, B02 Mounting Hole	PE4420	\$14.35	\$13.35	\$12.34	\$11.48	30		
		RG59, RG62, B02 Mounting Hole	PE4914	\$20.77	\$19.32	\$17.86	\$16.62	31		
	Crimp/Solder (Captive Contact)	RG55, RG142, RG223, RG400, B02 Mounting Hole	PE4419	\$15.00	\$13.95	\$12.90	\$12.00	32		
		RG316, RG174, RG188, B02 Mounting Hole	PE4187	\$15.66	\$14.56	\$13.47	\$12.53	33		
			Clamp/Solder	RG188-DS, RG316-DS, B02 Mounting Hole	PE4424	\$31.00	\$28.83	\$26.66	\$24.80	34
				RG178, RG196, B02 Mounting Hole	PE4421	\$22.29	\$20.73	\$19.17	\$17.83	35
				RG316, RG174, RG188, B02 Mounting Hole	PE4032	\$25.65	\$23.85	\$22.06	\$20.52	36
				RG58, RG55, RG142, RG223, B02 Mounting Hole	PE4033	\$26.95	\$25.06	\$23.18	\$21.56	37
			Solder/Solder	RG188-DS, RG316-DS, B02 Mounting Hole	PE4426	\$15.35	\$14.28	\$13.20	\$12.28	38
				PE-020SR, B02 Mounting Hole, .020" Semi-Rigid	PE4924	\$45.55	\$42.36	\$39.17	\$36.44	39
				PE-034SR, B02 Mounting Hole, .034" Semi-Rigid	PE4923	\$47.37	\$44.05	\$40.74	\$37.90	40
				PE-047SR, PE-SR047AL, PE-SR047FL, B02 Mounting Hole, .047" Semi-Rigid	PE4581	\$36.83	\$34.25	\$31.67	\$29.46	41
PE-SR401AL, PE-SR401FL, RG401, B02 Mounting Hole, .250" Semi-Rigid	PE4931			\$27.92	\$25.97	\$24.01	\$22.34	42		
PE-SR402AL, PE-SR402FL, RG402, B02 Mounting Hole, .141" Semi-Rigid	PE4120			\$11.49	\$10.69	\$9.88	\$9.19	43		
PE-SR405AL, PE-SR405FL, RG405, B02 Mounting Hole, .085" Semi-Rigid	PE4119			\$14.58	\$13.56	\$12.54	\$11.66	44		
RG178, RG196, B02 Mounting Hole	PE4423			\$20.05	\$18.65	\$17.24	\$16.04	45		
	Solder/Solder (Captive Contact)	RG316, RG174, RG188, B02 Mounting Hole	PE4188	\$14.10	\$13.11	\$12.13	\$11.28	46		
		RG58, RG55, RG142, RG223, B02 Mounting Hole	PE4353	\$14.45	\$13.44	\$12.43	\$11.56	47		
		RG316, RG174, RG188, B02 Mounting Hole	PE4428	\$15.65	\$14.55	\$13.46	\$12.52	48		

## Female Straight, Panel Mount, Cable Connectors

	Solder/Solder	2 Hole Flange, PE-047SR, PE-SR047AL, PE-SR047FL, C01 Mounting Hole, .047" Semi-Rigid	PE4547	\$20.06	\$18.66	\$17.25	\$16.05	49
		2 Hole Flange, PE-SR402AL, PE-SR402FL, RG402, C02 Mounting Hole, .141" Semi-Rigid	PE4196	\$19.51	\$18.14	\$16.78	\$15.61	50
		2 Hole Flange, PE-SR405AL, PE-SR405FL, RG405, C03 Mounting Hole, .085" Semi-Rigid	PE4197	\$17.63	\$16.40	\$15.16	\$14.10	51

# SMA Connectors

Product Image	Attachment Cable/Contact	Coax Type / Termination Type	Model No.	Price				Row
				1-24	25-49	50-99	100 +	
	Clamp/Solder	4 Hole Flange, RG316, RG174, RG188, A01 Mounting Hole	PE4034	\$43.52	\$40.47	\$37.43	\$34.82	1
		4 Hole Flange, RG58, RG55, RG141, RG142, RG400, RG223, A01 Mounting Hole	PE4035	\$43.52	\$40.47	\$37.43	\$34.82	2
	Solder/Solder	4 Hole Flange, PE-047SR, PE-SR047AL, PE-SR047FL, A01 Mounting Hole, .047" Semi-Rigid	PE4548	\$28.73	\$26.72	\$24.71	\$22.98	3
		4 Hole Flange, PE-SR402AL, PE-SR402FL, RG402, A01 Mounting Hole, .141" Semi-Rigid	PE4121	\$25.49	\$23.71	\$21.92	\$20.39	4
		4 Hole Flange, PE-SR405AL, PE-SR405FL, RG405, A01 Mounting Hole, .085" Semi-Rigid	PE4122	\$22.45	\$20.88	\$19.31	\$17.96	5

## Reverse Polarity Male Straight, Cable Connectors

	Crimp/Solder	RG8X, PE-C240	PE44664	\$19.25	\$17.90	\$16.56	\$15.40	6
		PE-B400, PE-B405, PE-C400, .400 inch	PE44666	\$23.61	\$21.96	\$20.30	\$18.89	7
		RG174, RG316, RG188	PE4771	\$14.08	\$13.09	\$12.11	\$11.26	8
		RG178, RG196	PE4774	\$22.34	\$20.78	\$19.21	\$17.87	9
		RG180, RG195	PE4777	\$23.66	\$22.00	\$20.35	\$18.93	10
		RG58	PE4769	\$17.00	\$15.81	\$14.62	\$13.60	11
	Clamp/Solder	RG55, RG141, RG142, RG223, RG400	PE4767	\$14.84	\$13.80	\$12.76	\$11.87	12
		RG174, RG316, RG188	PE4770	\$24.88	\$23.14	\$21.40	\$19.90	13
		RG178, RG196	PE4773	\$22.34	\$20.78	\$19.21	\$17.87	14
		RG180, RG195	PE4776	\$22.34	\$20.78	\$19.21	\$17.87	15
		RG58, RG55, RG141, RG142, RG223, RG400	PE4766	\$24.88	\$23.14	\$21.40	\$19.90	16
		PE-SR402AL, PE-SR402FL, RG402, .141" Semi-Rigid	PE4778	\$18.59	\$17.29	\$15.99	\$14.87	17
	Solder/Solder	PE-SR405AL, PE-SR405FL, RG405, .085" Semi-Rigid	PE4779	\$18.59	\$17.29	\$15.99	\$14.87	18
		RG174, RG316, RG188	PE4772	\$16.65	\$15.48	\$14.32	\$13.32	19
		RG178, RG196	PE4775	\$16.35	\$15.21	\$14.06	\$13.08	20
		RG58, RG55, RG141, RG142, RG223, RG400	PE4768	\$16.65	\$15.48	\$14.32	\$13.32	21

## Reverse Polarity Male Right Angle, Cable Connectors

	Crimp/Solder	RG174, RG316, RG188	PE4785	\$31.11	\$28.93	\$26.75	\$24.89	22
		RG178, RG196	PE4788	\$31.11	\$28.93	\$26.75	\$24.89	23
		RG58	PE4783	\$26.20	\$24.37	\$22.53	\$20.96	24
	Clamp/Solder	RG55, RG141, RG142, RG223, RG400	PE4781	\$29.39	\$27.33	\$25.28	\$23.51	25
		RG174, RG316, RG188	PE4784	\$37.34	\$34.73	\$32.11	\$29.87	26
		RG178, RG196	PE4787	\$76.35	\$71.01	\$65.66	\$61.08	27
	Solder/Solder	RG58, RG55, RG141, RG142, RG223, RG400	PE4780	\$31.11	\$28.93	\$26.75	\$24.89	28
		PE-SR402AL, PE-SR402FL, RG402, .141" Semi-Rigid	PE4790	\$31.11	\$28.93	\$26.75	\$24.89	29
		PE-SR405AL, PE-SR405FL, RG405, .085" Semi-Rigid	PE4791	\$31.11	\$28.93	\$26.75	\$24.89	30
		RG174, RG316, RG188	PE4786	\$27.90	\$25.95	\$23.99	\$22.32	31
		RG178, RG196	PE4789	\$31.11	\$28.93	\$26.75	\$24.89	32
		RG58, RG55, RG141, RG142, RG400, RG223	PE4782	\$27.90	\$25.95	\$23.99	\$22.32	33

## Reverse Polarity Female Straight, Cable Connectors

	Crimp/Solder	RG8X, PE-C240	PE44665	\$20.42	\$18.99	\$17.56	\$16.34	34
		PE-C400	PE44667	\$24.67	\$22.94	\$21.22	\$19.74	35
		RG174, RG316, RG188	PE4797	\$21.13	\$19.65	\$18.17	\$16.90	36
		RG178, RG196	PE4799	\$22.34	\$20.78	\$19.21	\$17.87	37
		RG58	PE4795	\$20.50	\$19.07	\$17.63	\$16.40	38
		RG55, RG141, RG142, RG223, RG400	PE4793	\$23.66	\$22.00	\$20.35	\$18.93	39
	Clamp/Solder	RG174, RG316, RG188	PE4796	\$24.88	\$23.14	\$21.40	\$19.90	40
		RG178, RG196	PE4850	\$24.88	\$23.14	\$21.40	\$19.90	41
		RG58, RG55, RG141, RG142, RG400, RG223	PE4792	\$24.88	\$23.14	\$21.40	\$19.90	42
	Solder/Solder	PE-SR402AL, PE-SR402FL, RG402, .141" Semi-Rigid	PE4852	\$23.66	\$22.00	\$20.35	\$18.93	43
		PE-SR405AL, PE-SR405FL, RG405, .085" Semi-Rigid	PE4853	\$23.66	\$22.00	\$20.35	\$18.93	44
		RG174, RG316, RG188	PE4798	\$20.50	\$19.07	\$17.63	\$16.40	45
		RG178, RG196	PE4851	\$20.10	\$18.69	\$17.29	\$16.08	46
		RG58, RG55, RG141, RG142, RG400, RG223	PE4794	\$20.10	\$18.69	\$17.29	\$16.08	47

## Reverse Polarity Female Straight, Bulkhead Mount, Cable Connectors

	Crimp/Solder	RG174, RG316, RG188, B02 Mounting Hole	PE4859	\$20.67	\$19.22	\$17.78	\$16.54	48
		RG178, RG196, B02 Mounting Hole	PE4862	\$21.13	\$19.65	\$18.17	\$16.90	49
		RG58, B02 Mounting Hole	PE4857	\$19.30	\$17.95	\$16.60	\$15.44	50
		RG55, RG141, RG142, RG223, RG400, B02 Mounting Hole	PE4855	\$19.96	\$18.56	\$17.17	\$15.97	51
	Clamp/Solder	RG174, RG316, RG188, B02 Mounting Hole	PE4858	\$31.11	\$28.93	\$26.75	\$24.89	52
		RG178, RG196, B02 Mounting Hole	PE4861	\$31.11	\$28.93	\$26.75	\$24.89	53
		RG58, RG55, RG141, RG142, RG400, RG223, B02 Mounting Hole	PE4854	\$31.11	\$28.93	\$26.75	\$24.89	54

Connectors

See Our Website For Real-Time Stock Availability!

Free Freight Available via UPS Ground to USA & Canada



Real-Time Stock Levels & Pricing On Our Website



Toll-Free Technical Support (866) 727-8376











Same-Day Shipping, Even Custom Cable Assemblies

# SMA Connectors





Connectors

See Our Website For Real-Time Stock Availability!

Product Image	Attachment Cable/Contact	Coax Type / Termination Type	Model No.	Price				Row
				1-24	25-49	50-99	100 +	
	Solder/Solder	PE-SR402AL, PE-SR402FL, RG402, B02 Mounting Hole, .141" Semi-Rigid	PE4864	\$26.14	\$24.31	\$22.48	\$20.91	1
		PE-SR405AL, PE-SR405FL, RG405, B02 Mounting Hole, .085" Semi-Rigid	PE4865	\$27.36	\$25.44	\$23.53	\$21.89	2
		RG174, RG316, RG188, B02 Mounting Hole	PE4860	\$20.10	\$18.69	\$17.29	\$16.08	3
		RG178, RG196, B02 Mounting Hole	PE4863	\$21.20	\$19.72	\$18.23	\$16.96	4
		RG58, RG55, RG141, RG142, RG400, RG223, B02 Mounting Hole	PE4856	\$20.10	\$18.69	\$17.29	\$16.08	5
<b>Reverse Thread Male Straight, Cable Connectors</b>								
	Crimp/Solder	RG174, RG316, RG188	PE44184	\$18.59	\$17.29	\$15.99	\$14.87	6
		RG178, RG196	PE44185	\$18.59	\$17.29	\$15.99	\$14.87	7
		RG58	PE44183	\$17.00	\$15.81	\$14.62	\$13.60	8
		RG55, RG141, RG142, RG223, RG400	PE44182	\$18.59	\$17.29	\$15.99	\$14.87	9
<b>Reverse Thread Male Right Angle, Cable Connectors</b>								
	Crimp/Solder	RG174, RG316, RG188	PE44188	\$32.37	\$30.10	\$27.84	\$25.90	10
		RG178, RG196	PE44189	\$32.37	\$30.10	\$27.84	\$25.90	11
		RG58	PE44187	\$29.55	\$27.48	\$25.41	\$23.64	12
		RG55, RG141, RG142, RG223, RG400	PE44186	\$32.37	\$30.10	\$27.84	\$25.90	13
<b>Reverse Thread Female Straight, Cable Connectors</b>								
	Crimp/Solder	RG174, RG316, RG188	PE44192	\$21.13	\$19.65	\$18.17	\$16.90	14
		RG178, RG196	PE44193	\$21.13	\$19.65	\$18.17	\$16.90	15
		RG58	PE44191	\$20.50	\$19.07	\$17.63	\$16.40	16
		RG55, RG141, RG142, RG223, RG400	PE44190	\$21.13	\$19.65	\$18.17	\$16.90	17
<b>Reverse Thread Female Straight, Bulkhead Mount, Cable Connectors</b>								
	Crimp/Solder	RG174, RG316, RG188, B02 Mounting Hole	PE44196	\$24.88	\$23.14	\$21.40	\$19.90	18
		RG178, RG196, B02 Mounting Hole	PE44197	\$24.88	\$23.14	\$21.40	\$19.90	19
		RG58, B02 Mounting Hole	PE44195	\$22.30	\$20.74	\$19.18	\$17.84	20
		RG55, RG141, RG142, RG223, RG400, B02 Mounting Hole	PE44194	\$24.88	\$23.14	\$21.40	\$19.90	21
<b>Male Straight, Bulkhead Mount, Terminal</b>								
	Solder	Solder Cup Contact, Front Mount, .125" Max Panel, .380" x .350" Mounting Hole Size, B04 Mounting Hole	PE4544	\$20.77	\$19.32	\$17.86	\$16.62	22
		Solder Cup Contact, Front Mount, .125" Max Panel, .250" x .235" Mounting Hole Size, B02 Mounting Hole	PE4354	\$14.14	\$13.15	\$12.16	\$11.31	23
		.020" Dia. Stub Contact, Front Mount, Hermetically Sealed w/o-ring, F01 Mounting Hole	PE4531	\$28.73	\$26.72	\$24.71	\$22.98	24
<b>Male Straight, Panel Mount, Terminal</b>								
	Solder	2 Hole Flange, .050" Stub Contact, .330" Extended Dielectric, C02 Mounting Hole	PE4127	\$18.59	\$17.29	\$15.99	\$14.87	25
		2 Hole Flange, Solder Cup Contact, C01 Mounting Hole	PE4125	\$20.27	\$18.85	\$17.43	\$16.22	26
		4 Hole Flange, .050" Stub Contact, .330" Extended Dielectric, A01 Mounting Hole	PE4126	\$17.18	\$15.98	\$14.77	\$13.74	27
		4 Hole Flange, Solder Cup Contact, A01 Mounting Hole	PE4124	\$17.63	\$16.40	\$15.16	\$14.10	28
		4 Hole Flange, .020" Dia Stub Contact, Hermetically Sealed w/o-ring, A01 Mounting Hole	PE4541	\$37.34	\$34.73	\$32.11	\$29.87	29
<b>Female Straight, PCB Mount, Terminal</b>								
	Solder	Stripline End Launch, 1/16" Ground Plane Spacing, Captive Tab Contact	PE4534	\$33.13	\$30.81	\$28.49	\$26.50	30
		Stripline End Launch, 1/4" Ground Plane Spacing, Captive Tab Contact	PE4535	\$46.31	\$43.07	\$39.83	\$37.05	31
		Stripline End Launch, 1/8" Ground Plane Spacing, Captive Tab Contact	PE4190	\$34.86	\$32.42	\$29.98	\$27.89	32
		.050" Dia. Contact, .155" Leg Length, D01 Mounting Hole	PE4117	\$12.59	\$11.71	\$10.83	\$10.07	33
<b>Female Right Angle, PCB Mount, Terminal</b>								
	Solder	.050" Dia. Contact, .155" Leg Length, D01 Mounting Hole	PE4118	\$14.74	\$13.71	\$12.68	\$11.79	34

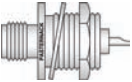
Yottahertz (YHz) = 10<sup>24</sup> Hertz or One Septillion Hertz.

# SMA Connectors

Product Image	Attachment Cable/Contact	Coax Type / Termination Type	Model No.	Price				Row
				1-24	25-49	50-99	100 +	
<b>Female Straight, Bulkhead Mount, Terminal</b>								
	Solder	.050" Dia. Stub Contact, 27 GHz Precision, Max VSWR 1.20:1, F01 Mounting Hole	PE44344	\$37.34	\$34.73	\$32.11	\$29.87	1
		.050" Dia. Stub Contact, F01 Mounting Hole	PE4189	\$10.99	\$10.22	\$9.45	\$8.79	2
		Solder Cup Contact, Front Mount, .250" Max Panel, B04 Mounting Hole	PE4536	\$47.98	\$44.62	\$41.26	\$38.38	3
		Solder Cup Contact, Rear Mount, w/o-ring, .093" Max Panel, B02 Mounting Hole	PE4529	\$16.82	\$15.64	\$14.47	\$13.46	4
		Solder Cup Contact, Rear Mount, .160" Max Panel, B02 Mounting Hole	PE4101	\$10.94	\$10.17	\$9.41	\$8.75	5
		Solder Cup Contact, Front Mount, .125" Max Panel, B02 Mounting Hole	PE4219	\$9.91	\$9.22	\$8.52	\$7.93	6
		Solder Cup Contact, F01 Mounting Hole	PE4549	\$15.60	\$14.51	\$13.42	\$12.48	7
		.020" Dia. Stub Contact, Rear Mount, Hermetically Sealed w/o-ring, .125" Max Panel, B02 Mounting Hole	PE4528	\$24.57	\$22.85	\$21.13	\$19.66	8
		.020" Dia. Stub Contact, Hermetically Sealed, F01 Mounting Hole	PE4532	\$19.96	\$18.56	\$17.17	\$15.97	9
.020" Dia. Stub Contact, Front Mount, Hermetically Sealed w/o-ring, F01 Mounting Hole	PE4530	\$24.67	\$22.94	\$21.22	\$19.74	10		
<b>Female Right Angle, Bulkhead Mount, Terminal</b>								
	Solder	Solder Cup Contact, .125" Max Panel, B02 Mounting Hole	PE4300	\$37.34	\$34.73	\$32.11	\$29.87	11
<b>Female Straight, Panel Mount, Terminal</b>								
	Solder	2 Hole Flange, .010" Stub Contact, .125" Extended Dielectric, C01 Mounting Hole	PE4001	\$13.37	\$12.43	\$11.50	\$10.70	12
		2 Hole Flange, .050" Stub Contact, .590" Extended Dielectric, 27 GHz Precision, Max VSWR: 1.20:1, C01 Mounting Hole	PE44343	\$37.64	\$35.01	\$32.37	\$30.11	13
		2 Hole Flange, .050" Stub Contact, .590" Extended Dielectric, .625" Flange Size, C01 Mounting Hole	PE4128	\$13.88	\$12.91	\$11.94	\$11.10	14
		2 Hole Flange, Removable Tab Contact, Flush Dielectric, C01 Mounting Hole	PE4370	\$18.59	\$17.29	\$15.99	\$14.87	15
		2 Hole Flange, Solder Cup Contact, 27 GHz Precision, Max VSWR 1.20:1, C01 Mounting Hole	PE44341	\$37.34	\$34.73	\$32.11	\$29.87	16
		2 Hole Flange, Solder Cup Contact, .625" Flange Size, C01 Mounting Hole	PE4004	\$11.75	\$10.93	\$10.11	\$9.40	17
		2 Hole Flange, .010" Stub Contact, .125" Extended Dielectric, 27 GHz Precision, Max VSWR: 1.20:1, C01 Mounting Hole	PE44340	\$47.37	\$44.05	\$40.74	\$37.90	18
		4 Hole Flange, .050" Stub Contact, .590" Extended Dielectric, .687" Flange Size, A04 Mounting Hole	PE4533	\$18.39	\$17.10	\$15.82	\$14.71	19
		4 Hole Flange, .050" Stub Contact, .590" Extended Dielectric, .500" Flange Size, A01 Mounting Hole	PE4099	\$12.11	\$11.26	\$10.41	\$9.69	20
		4 Hole Flange, Removable Tab Contact, Flush Dielectric, .500" x .375" Flange Mount, E01 Mounting Hole	PE4539	\$23.66	\$22.00	\$20.35	\$18.93	21
		4 Hole Flange, Removable Tab Contact, Flush Dielectric, 1" Flange Size, A05 Mounting Hole	PE4546	\$32.07	\$29.83	\$27.58	\$25.66	22
		4 Hole Flange, Removable Tab Contact, Flush Dielectric, A01 Mounting Hole	PE4186	\$11.75	\$10.93	\$10.11	\$9.40	23
		4 Hole Flange, .012" Width Slot in Contact, 1" Flange Size, A05 Mounting Hole	PE4216	\$21.13	\$19.65	\$18.17	\$16.90	24
		4 Hole Flange, .050" Stub Contact, .590" Extended Dielectric, .375" x .500" Flange Size, E01 Mounting Hole	PE4538	\$30.85	\$28.69	\$26.53	\$24.68	25
		4 Hole Flange, .012" Width Slot in Contact, .500" Flange Size, A01 Mounting Hole	PE4217	\$15.30	\$14.23	\$13.16	\$12.24	26
		4 Hole Flange, Solder Cup Contact, .500" Flange Size, A01 Mounting Hole	PE4000	\$15.50	\$14.42	\$13.33	\$12.40	27
		4 Hole Flange, Solder Cup Contact, .500" x .375" Flange Size, E01 Mounting Hole	PE4537	\$23.66	\$22.00	\$20.35	\$18.93	28
		4 Hole Flange, Solder Cup Contact, 1" Flange Size, A05 Mounting Hole	PE4218	\$18.59	\$17.29	\$15.99	\$14.87	29
		4 Hole Flange, Solder Cup Contact, .687" Flange Size, A04 Mounting Hole	PE4527	\$18.59	\$17.29	\$15.99	\$14.87	30
		4 Hole Flange, .020" Stub Contact, Hermetically Sealed w/o-ring, A01 Mounting Hole	PE4540	\$33.84	\$31.47	\$29.10	\$27.07	31
<b>Female Right Angle, Panel Mount, Terminal</b>								
	Solder	2 Hole Flange, .050" Dia. Stub Contact, .250" Extended Dielectric, 90° Flange Direction, C01 Mounting Hole	PE44593	\$34.86	\$32.42	\$29.98	\$27.89	32
		2 Hole Flange, .050" Dia. Stub Contact, .590" Extended Dielectric, -45° Flange Direction, C01 Mounting Hole	PE44239	\$34.86	\$32.42	\$29.98	\$27.89	33
		2 Hole Flange, .050" Dia. Stub Contact, .590" Extended Dielectric, +45° Flange Direction, C01 Mounting Hole	PE44238	\$34.86	\$32.42	\$29.98	\$27.89	34
		2 Hole Flange, .050" Dia. Stub Contact, .590" Extended Dielectric, 90° Flange Direction, C01 Mounting Hole	PE44237	\$41.90	\$38.97	\$36.03	\$33.52	35
		Radius 4 Hole Flange, Solder Cup Contact, .500" Flange Size, A01 Mounting Hole	PE4220	\$52.13	\$48.48	\$44.83	\$41.70	36
		4 Hole Flange, .050" Dia. Contact, .590" Extended Dielectric, A01 Mounting Hole	PE44236	\$34.04	\$31.66	\$29.27	\$27.23	37
		4 Hole Flange, Solder Cup Contact, A01 Mounting Hole	PE4123	\$28.93	\$26.90	\$24.88	\$23.14	38

Connectors

See Our Website For Real-Time Stock Availability!

















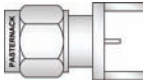

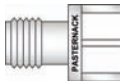
# SMA Connectors

Connectors

See Our Website For Real-Time Stock Availability!

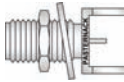
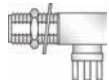
Product Image	Attachment Cable/Contact	Coax Type / Termination Type	Model No.	Price				Row
				1-24	25-49	50-99	100 +	
<b>Female Straight, Press In Mount, Terminal</b>								
	Solder	.010" X .020" Tab Contact, F07 Mounting Hole	PE44240	\$21.13	\$19.65	\$18.17	\$16.90	1
		.030" Dia Contact, F07 Mounting Hole	PE44241	\$21.13	\$19.65	\$18.17	\$16.90	2
<b>Reverse Polarity Female Straight, Bulkhead Mount, Terminal</b>								
	Solder	Solder Cup Contact, Front Mount, .125" Max Panel, B02 Mounting Hole	PE4871	\$17.63	\$16.40	\$15.16	\$14.10	3
		Solder Cup Contact, Rear Mount, .150" Max Panel, B02 Mounting Hole	PE4868	\$16.16	\$15.03	\$13.90	\$12.93	4
<b>Reverse Polarity Female Straight, Panel Mount, Terminal</b>								
	Solder	2 Hole Flange, Solder Cup Contact, .625" Flange Size, C01 Mounting Hole	PE4867	\$19.91	\$18.52	\$17.12	\$15.93	5
		4 Hole Flange, Solder Cup Contact, .500" Flange Size, A01 Mounting Hole	PE4866	\$18.59	\$17.29	\$15.99	\$14.87	6
<b>Reverse Thread Female Straight, PCB Mount, Terminal</b>								
	Solder	.050" Dia. Contact, .155" Leg Length, D01 Mounting Hole	PE44198	\$21.13	\$19.65	\$18.17	\$16.90	7
<b>Reverse Thread Female Right Angle, PCB Mount, Terminal</b>								
	Solder	.050" Dia. Contact, .155" Leg Length, D01 Mounting Hole	PE44199	\$23.66	\$22.00	\$20.35	\$18.93	8
<b>Reverse Thread Female Straight, Panel Mount, Terminal</b>								
	Solder	4 Hole Flange, Solder Cup Contact, .500" Flange Size, A01 Mounting Hole	PE44200	\$23.66	\$22.00	\$20.35	\$18.93	9
<b>Male Straight, PCB Mount</b>								
	Solder	End Launch, .042" Board Thickness, .020" x .010" Tab Contact	PE44210	\$24.83	\$23.09	\$21.35	\$19.86	10
		End Launch, .042" Board Thickness, .030" Round Contact	PE44209	\$23.05	\$21.44	\$19.82	\$18.44	11
		End Launch, .062" Board Thickness, .020" x .010" Tab Contact	PE4913	\$22.34	\$20.78	\$19.21	\$17.87	12
		End Launch, .062" Board Thickness, .030" Round Contact	PE4912	\$21.13	\$19.65	\$18.17	\$16.90	13
		.050" Dia. Contact, .155" Leg Length, D01 Mounting Hole	PE4525	\$16.31	\$15.17	\$14.03	\$13.05	14
<b>Male Right Angle, PCB Mount</b>								
	Solder	.050" Dia. Contact, .155" Leg Length, D01 Mounting Hole	PE4526	\$26.65	\$24.78	\$22.92	\$21.32	15
<b>Female Straight, PCB Mount</b>								
	Solder	End Launch, .031" Board Thickness, .030" Round Contact	PE44206	\$14.34	\$13.34	\$12.33	\$11.47	16
		End Launch, .042" Board Thickness, .020" x .010" Tab Contact	PE44207	\$18.44	\$17.15	\$15.86	\$14.75	17
		End Launch, .042" Board Thickness, .030" Round Contact	PE44204	\$17.28	\$16.07	\$14.86	\$13.82	18
		End Launch, .047" Board Thickness, .020" x .010" Tab Contact	PE44208	\$19.20	\$17.86	\$16.51	\$15.36	19
		End Launch, .047" Board Thickness, .030" Round Contact	PE44205	\$19.76	\$18.38	\$16.99	\$15.81	20
		End Launch, .062" Board Thickness, .030" Round Contact	PE4542	\$13.88	\$12.91	\$11.94	\$11.10	21
		End Launch, .062" Board Thickness, .020" x .010" Tab Contact	PE4543	\$14.06	\$13.08	\$12.09	\$11.25	22
		Surface Mount, .050" Dia. Contact	PE4910	\$12.72	\$11.83	\$10.94	\$10.18	23
		Surface Mount, End Launch, .030" Dia. Contact	PE44235	\$15.30	\$14.23	\$13.16	\$12.24	24
		.050" Dia. Contact, .155" Leg Length, 27 GHz Precision, Max VSWR 1.20:1, D01 Mounting Hole	PE44342	\$41.34	\$38.45	\$35.55	\$33.07	25
<b>Female Right Angle, PCB Mount</b>								
	Solder	Surface Mount, .050" Dia. Contact	PE4911	\$19.40	\$18.04	\$16.68	\$15.52	26

# SMA Connectors

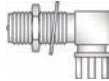
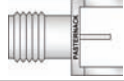
Product Image	Attachment Cable/Contact	Coax Type / Termination Type	Model No.	Price				Row
				1-24	25-49	50-99	100 +	
<b>Female Straight, Bulkhead Mount, PCB Mount</b>								
	Solder	End Launch, .042" Board Thickness, .030" Round Contact, F01 Mounting Hole	PE44211	\$18.75	\$17.44	\$16.13	\$15.00	1
		End Launch, .042" Board Thickness, .020" x .010" Tab Contact, F01 Mounting Hole	PE44213	\$19.91	\$18.52	\$17.12	\$15.93	2
		End Launch, .062" Board Thickness, .020" x .010" Tab Contact, F01 Mounting Hole	PE44214	\$18.75	\$17.44	\$16.13	\$15.00	3
		End Launch, .062" Board Thickness, .030" Round Contact, F01 Mounting Hole	PE44212	\$18.75	\$17.44	\$16.13	\$15.00	4
		.050" Dia. Contact, .155" Leg Length, .125" Max Panel, D01 & B02 Mounting Hole	PE4524	\$13.58	\$12.63	\$11.68	\$10.86	5
<b>Female Right Angle, Bulkhead Mount, PCB Mount</b>								
	Solder	.050" Dia. Contact, .155" Leg Length, .125" Max Panel, D01 & B02 Mounting Hole	PE4545	\$22.24	\$20.68	\$19.13	\$17.79	6
<b>Reverse Polarity Male Straight, PCB Mount</b>								
	Solder	.050" Dia. Contact, .155" Leg Length, D01 Mounting Hole	PE4873	\$18.59	\$17.29	\$15.99	\$14.87	7
<b>Reverse Polarity Female Straight, PCB Mount</b>								
	Solder	End Launch, .062" Board Thickness, .030" Round Contact	PE4874	\$19.25	\$17.90	\$16.56	\$15.40	8
		.050" Dia. Contact, .155" Leg Length, D01 Mounting Hole	PE4869	\$16.42	\$15.27	\$14.12	\$13.14	9
<b>Reverse Polarity Female Right Angle, PCB Mount</b>								
	Solder	.050" Dia. Contact, .155" Leg Length, D01 Mounting Hole	PE4870	\$24.88	\$23.14	\$21.40	\$19.90	10
<b>Reverse Polarity Female Straight, Bulkhead Mount, PCB Mount</b>								
	Solder	.050" Dia Contact, .155" Leg Length, .125" Max Panel, D01 & F01 Mounting Hole	PE4872	\$18.24	\$16.96	\$15.69	\$14.59	11
<b>Reverse Polarity Female Right Angle, Bulkhead Mount, PCB Mount</b>								
	Solder	.050" Dia. Contact, .155" Leg Length, .190" Max Panel, D01 & F01 Mounting Hole	PE4875	\$33.64	\$31.29	\$28.93	\$26.91	12
<b>Reverse Thread Female Straight, PCB Mount</b>								
	Solder	End Launch, .062" Board Thickness, .020" x .010" Tab Contact	PE44202	\$21.13	\$19.65	\$18.17	\$16.90	13
		End Launch, .062" Board Thickness, .030" Round Contact	PE44201	\$21.13	\$19.65	\$18.17	\$16.90	14

Connectors

See Our Website For Real-Time Stock Availability!

The GPS project was started in 1973 and was originally run with 24 satellites, known as the Navstar Constellation. It became fully operational in 1994.

# SMA Connectors

Connectors

See Our Website For Real-Time Stock Availability!

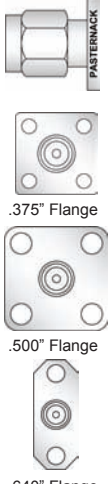
Product Image	Attachment Cable/Contact	Coax Type / Termination Type	Model No.	Price				Row
				1-24	25-49	50-99	100 +	
<b>Male Straight, Panel Mount, Field Replaceable</b>								
 <p>.375" Flange</p> <p>.500" Flange</p> <p>.640" Flange</p>	Mechanical	2 Hole Flange, .640" Flange Size, Accepts .012 Pin Size, Includes EMI/RFI Gasket	PE44028	\$31.11	\$28.93	\$26.75	\$24.89	1
		2 Hole Flange, .640" Flange Size, Accepts .015 Pin Size, Includes EMI/RFI Gasket	PE44029	\$31.11	\$28.93	\$26.75	\$24.89	2
		2 Hole Flange, .640" Flange Size, Accepts .018 Pin Size, Includes EMI/RFI Gasket	PE44030	\$31.11	\$28.93	\$26.75	\$24.89	3
		2 Hole Flange, .640" Flange Size, Accepts .020 Pin Size	PE44031	\$31.11	\$28.93	\$26.75	\$24.89	4
		2 Hole Flange, .640" Flange Size, Accepts .036 Pin Size	PE44032	\$31.11	\$28.93	\$26.75	\$24.89	5
		4 Hole Flange, .500" Flange Size, Accepts .012 Pin Size, Includes EMI/RFI Gasket	PE44018	\$31.11	\$28.93	\$26.75	\$24.89	6
		4 Hole Flange, .375" Flange Size, Accepts .012 Pin Size, Includes EMI/RFI Gasket	PE44005	\$31.11	\$28.93	\$26.75	\$24.89	7
		4 Hole Flange, .500" Flange Size, Accepts .015 Pin Size, Includes EMI/RFI Gasket	PE44019	\$31.11	\$28.93	\$26.75	\$24.89	8
		4 Hole Flange, .375" Flange Size, Accepts .015 Pin Size, Includes EMI/RFI Gasket	PE44006	\$31.11	\$28.93	\$26.75	\$24.89	9
		4 Hole Flange, .375" Flange Size, Accepts .018 Pin Size, Includes EMI/RFI Gasket	PE44007	\$31.11	\$28.93	\$26.75	\$24.89	10
		4 Hole Flange, .500" Flange Size, Accepts .018 Pin Size, Includes EMI/RFI Gasket	PE44020	\$31.11	\$28.93	\$26.75	\$24.89	11
		4 Hole Flange, .500" Flange Size, Accepts .020 Pin Size	PE44021	\$31.11	\$28.93	\$26.75	\$24.89	12
		4 Hole Flange, .375" Flange Size, Accepts .020 Pin Size	PE44008	\$31.11	\$28.93	\$26.75	\$24.89	13
		4 Hole Flange, .375" Flange Size, Accepts .036 Pin Size	PE44009	\$31.11	\$28.93	\$26.75	\$24.89	14
4 Hole Flange, .500" Flange Size, Accepts .036 Pin Size	PE44022	\$31.11	\$28.93	\$26.75	\$24.89	15		

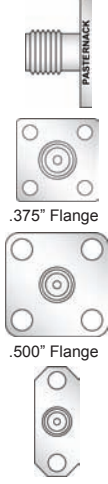
<b>Female Straight, Panel Mount, Field Replaceable</b>								
 <p>.375" Flange</p> <p>.500" Flange</p> <p>.640" Flange</p>	Mechanical	2 Hole Flange, .640" Flange Size, Accepts .012 Pin Size, Includes EMI/RFI Gasket	PE44023	\$30.35	\$28.23	\$26.10	\$24.28	16
		2 Hole Flange, .640" Flange Size, Accepts .015 Pin Size, Includes EMI/RFI Gasket	PE44024	\$24.88	\$23.14	\$21.40	\$19.90	17
		2 Hole Flange, .640" Flange Size, Accepts .018 Pin Size, Includes EMI/RFI Gasket	PE44025	\$27.00	\$25.11	\$23.22	\$21.60	18
		2 Hole Flange, .640" Flange Size, Accepts .020 Pin Size	PE44026	\$23.51	\$21.86	\$20.22	\$18.81	19
		2 Hole Flange, .640" Flange Size, Accepts .036 Pin Size	PE44027	\$24.88	\$23.14	\$21.40	\$19.90	20
		4 Hole Flange, .500" Flange Size, Accepts .012 Pin Size, Includes EMI/RFI Gasket	PE44010	\$24.88	\$23.14	\$21.40	\$19.90	21
		4 Hole Flange, .375" Flange Size, Accepts .012 Pin Size, Includes EMI/RFI Gasket	PE44000	\$26.04	\$24.22	\$22.39	\$20.83	22
		4 Hole Flange, .500" Flange Size, Accepts .015 Pin Size, Includes EMI/RFI Gasket	PE44011	\$24.88	\$23.14	\$21.40	\$19.90	23
		4 Hole Flange, .375" Flange Size, Accepts .015 Pin Size, Includes EMI/RFI Gasket	PE44001	\$26.04	\$24.22	\$22.39	\$20.83	24
		4 Hole Flange, .500" Flange Size, Accepts .018 Pin Size, Includes EMI/RFI Gasket	PE44012	\$24.88	\$23.14	\$21.40	\$19.90	25
		4 Hole Flange, .375" Flange Size, Accepts .018 Pin Size, Includes EMI/RFI Gasket	PE44002	\$26.04	\$24.22	\$22.39	\$20.83	26
		4 Hole Flange, .500" Flange Size, Accepts .020 Pin Size	PE44013	\$24.88	\$23.14	\$21.40	\$19.90	27
		4 Hole Flange, .375" Flange Size, Accepts .020 Pin Size	PE44003	\$24.57	\$22.85	\$21.13	\$19.66	28
		4 Hole Flange, .500" Flange Size, Accepts .036 Pin Size	PE44014	\$24.88	\$23.14	\$21.40	\$19.90	29
4 Hole Flange, .375" Flange Size, Accepts .036 Pin Size	PE44004	\$26.04	\$24.22	\$22.39	\$20.83	30		

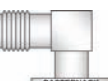
<b>Female Right Angle, Panel Mount, Field Replaceable</b>								
	Mechanical	4 Hole Flange, .500" Flange Size, Accepts .012 Pin Size, Includes EMI/RFI Gasket	PE44015	\$38.15	\$35.48	\$32.81	\$30.52	31
		4 Hole Flange, .500" Flange Size, Accepts .015 Pin Size, Includes EMI/RFI Gasket	PE44016	\$37.34	\$34.73	\$32.11	\$29.87	32
		4 Hole Flange, .500" Flange Size, Accepts .018 Pin Size, Includes EMI/RFI Gasket	PE44017	\$47.57	\$44.24	\$40.91	\$38.06	33



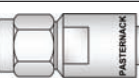

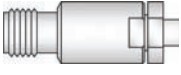
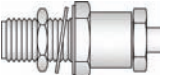

# 3.5mm Connectors

Product Image	Attachment Cable/Contact	Coax Type / Termination Type	Model No.	Price				Row
				1-24	25-49	50-99	100 +	
<b>Male Straight, Cable Connectors</b>								
	Clamp/Solder	PE-SR402AL, PE-SR402FL, RG402, .141" Semi-Rigid	PE4981	\$65.26	\$60.69	\$56.12	\$52.21	34
		PE-SR405AL, PE-SR405FL, RG405, .085" Semi-Rigid	PE4982	\$69.06	\$64.23	\$59.39	\$55.25	35

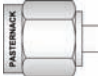
# 3.5mm Connectors

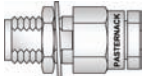
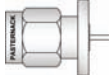
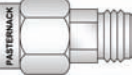
Product Image	Attachment Cable/Contact	Coax Type / Termination Type	Model No.	Price				Row
				1-24	25-49	50-99	100 +	
<b>Female Straight, Cable Connectors</b>								
	Clamp/Solder	PE-SR402AL, PE-SR402FL, RG402, .141" Semi-Rigid	PE4983	\$69.06	\$64.23	\$59.39	\$55.25	1
		PE-SR405AL, PE-SR405FL, RG405, .085" Semi-Rigid	PE4984	\$119.42	\$111.06	\$102.70	\$95.54	2
<b>Female Straight, Bulkhead Mount, Cable Connectors</b>								
	Clamp/Solder	PE-SR402AL, PE-SR402FL, RG402, B02 Mounting Hole, .141" Semi-Rigid	PE4985	\$216.64	\$201.48	\$186.31	\$173.31	3
		PE-SR405AL, PE-SR405FL, RG405, B02 Mounting Hole, .085" Semi-Rigid	PE4986	\$89.22	\$82.97	\$76.73	\$71.38	4

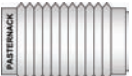
# 2.92mm Connectors

Product Image	Attachment Cable/Contact	Coax Type / Termination Type	Model No.	Price				Row
				1-24	25-49	50-99	100 +	
<b>Male Straight, Cable Connectors</b>								
	Solder	PE-SR402AL, PE-SR402FL, RG402, .141" Semi-Rigid	PE4987	\$35.26	\$32.79	\$30.32	\$28.21	5
		PE-SR405AL, PE-SR405FL, RG405, .085" Semi-Rigid	PE4988	\$36.51	\$33.95	\$31.40	\$29.21	6
		.118" Dia. Semi-Rigid	PE4989	\$49.91	\$46.42	\$42.92	\$39.93	7
<b>Female Straight, Cable Connectors</b>								
	Clamp/Solder	PE-SR402AL, PE-SR402FL, RG402, .141" Semi-Rigid	PE44227	\$87.30	\$81.19	\$75.08	\$69.84	8
		PE-SR405AL, PE-SR405FL, RG405, .085" Semi-Rigid	PE44228	\$87.30	\$81.19	\$75.08	\$69.84	9
<b>Female Straight, Bulkhead Mount, Cable Connectors</b>								
	Clamp/Solder	PE-SR402AL, PE-SR402FL, RG402, B02 Mounting Hole, .141" Semi-Rigid	PE4990	\$99.76	\$92.78	\$85.79	\$79.81	10
		PE-SR405AL, PE-SR405FL, RG405, B02 Mounting Hole, .085" Semi-Rigid	PE4992	\$112.22	\$104.36	\$96.51	\$89.78	11
<b>Male Straight, Panel Mount, Terminal</b>								
	Solder	2 Hole Flange, .025" Dia. Stub Contact, C06 Mounting Hole	PE44347	\$105.94	\$98.52	\$91.11	\$84.75	12
<b>Male Straight, Threaded Mount, Field Replaceable</b>								
	Mechanical	Accepts .012" Dia. Pin	PE44234	\$74.83	\$69.59	\$64.35	\$59.86	13
<b>Male Straight, Panel Mount, Field Replaceable</b>								
	Mechanical	2 Hole Flange, Accepts .012" Dia. Pin, C02 Mounting Hole	PE44232	\$53.60	\$49.85	\$46.10	\$42.88	14
		4 Hole Flange, Accepts .012" Dia. Pin, A01 Mounting Hole	PE44233	\$74.83	\$69.59	\$64.35	\$59.86	15
<b>Female Straight, Threaded Mount, Field Replaceable</b>								
	Mechanical	Accepts .012" Pin	PE44231	\$74.83	\$69.59	\$64.35	\$59.86	16
<b>Female Straight, Panel Mount, Field Replaceable</b>								
	Mechanical	2 Hole Flange, Accepts .012" Dia. Pin, C01 Mounting Hole	PE44229	\$93.48	\$86.94	\$80.39	\$74.78	17
		4 Hole Flange, Accepts .012" Dia. Pin, A01 Mounting Hole	PE44230	\$90.39	\$84.06	\$77.74	\$72.31	18

Connectors







See Our Website For Real-Time Stock Availability!



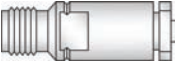

# 2.4mm Connectors

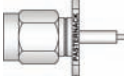
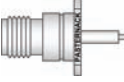
Connectors

See Our Website For Real-Time Stock Availability!

Product Image	Attachment Cable/Contact	Coax Type / Termination Type	Model No.	Price				Row
				1-24	25-49	50-99	100 +	
<b>Male Straight, Cable Connectors</b>								
	Clamp/Solder	PE-SR405AL, PE-SR405FL, RG405, .085" Semi-Rigid	PE44345	\$105.94	\$98.52	\$91.11	\$84.75	1
	Solder	PE-SR405AL, PE-SR405FL, RG405, .085" Semi-Rigid	PE44215	\$45.65	\$42.45	\$39.26	\$36.52	2
<b>Female Straight, Cable Connectors</b>								
	Clamp/Solder	PE-SR405AL, PE-SR405FL, RG405, .085" Semi-Rigid	PE44216	\$133.15	\$123.83	\$114.51	\$106.52	3
<b>Female Straight, Bulkhead Mount, Cable Connectors</b>								
	Clamp/Solder	PE-SR405AL, PE-SR405FL, RG405, B14 Mounting Hole, .085" Semi-Rigid	PE44346	\$112.22	\$104.36	\$96.51	\$89.78	4
<b>Male Straight, Panel Mount, Terminal</b>								
	Solder	2 Hole Flange, Tab, .003" X .011" Tab Contact, C05 Mounting Hole	PE44223	\$118.40	\$110.11	\$101.82	\$94.72	5
		2 Hole Flange, .024" Dia. Stub Contact, .250" Extended Dielectric, C05 Mounting Hole	PE44220	\$112.22	\$104.36	\$96.51	\$89.78	6
		4 Hole Flange, Tab, .003" X .011" Tab Contact, A01 Mounting Hole	PE44224	\$187.11	\$174.01	\$160.91	\$149.69	7
		4 Hole Flange, .024" Dia. Stub Contact, .250" Extended Dielectric, A01 Mounting Hole	PE44221	\$97.23	\$90.42	\$83.62	\$77.78	8
<b>Female Straight, Panel Mount, Terminal</b>								
	Solder	2 Hole Flange, Tab, .003" X .011" Tab Contact, C05 Mounting Hole	PE44225	\$124.69	\$115.96	\$107.23	\$99.75	9
		2 Hole Flange, .024" Dia Stub Contact, .250" Extended Dielectric, C05 Mounting Hole	PE44217	\$121.70	\$113.18	\$104.66	\$97.36	10
		4 Hole Flange, Tab, .003" X .011" Tab Contact, A01 Mounting Hole	PE44226	\$97.23	\$90.42	\$83.62	\$77.78	11
		4 Hole Flange, .024" Dia Stub Contact, .250" Extended Dielectric, A01 Mounting Hole	PE44218	\$102.80	\$95.60	\$88.41	\$82.24	12
<b>Male Straight, Threaded Mount, Field Replaceable</b>								
	Mechanical	Accepts .012" Dia. Pin	PE44222	\$97.23	\$90.42	\$83.62	\$77.78	13
<b>Female Straight, Threaded Mount, Field Replaceable</b>								
	Mechanical	Accepts .012" Dia. Pin	PE44219	\$97.23	\$90.42	\$83.62	\$77.78	14

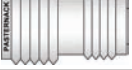

# 1.85mm Connectors

Product Image	Attachment Cable/Contact	Coax Type / Termination Type	Model No.	Price				Row
				1-24	25-49	50-99	100 +	
<b>Male Straight, Cable Connectors</b>								
	Clamp/Solder	PE-047SR, PE-SR047AL, PE-SR047FL, .047" Semi-Rigid	PE44335	\$124.69	\$115.96	\$107.23	\$99.75	15
		PE-SR405AL, PE-SR405FL, RG405, .085" Semi-Rigid	PE44336	\$112.22	\$104.36	\$96.51	\$89.78	16
<b>Male Straight, Threaded Mount, Field Replaceable</b>								
	Mechanical	Accepts .009" Dia. Pin	PE44338	\$112.22	\$104.36	\$96.51	\$89.78	17
<b>Female Straight, Threaded Mount, Field Replaceable</b>								
	Mechanical	Accepts .009" Dia. Pin	PE44339	\$112.22	\$104.36	\$96.51	\$89.78	18

# 1.85mm Connectors

Product Image	Attachment Cable/Contact	Coax Type / Termination Type	Model No.	Price				Row
				1-24	25-49	50-99	100 +	
<b>Female Straight, Panel Mount, Field Replaceable</b>								
	Mechanical	2 Hole Flange, Accepts .009" Dia. Pin, C01 Mounting Hole	PE44337	\$124.69	\$115.96	\$107.23	\$99.75	1

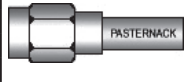
# SSMA Connectors

Product Image	Attachment Cable/Contact	Coax Type / Termination Type	Model No.	Price				Row
				1-24	25-49	50-99	100 +	
<b>Male Straight, Cable Connectors</b>								
	Crimp/Solder	RG188-DS, RG316-DS	PE44416	\$17.95	\$16.69	\$15.44	\$14.36	2
		RG174, RG316, RG188	PE44379	\$18.20	\$16.93	\$15.65	\$14.56	3
		RG178, RG196	PE44381	\$19.96	\$18.56	\$17.17	\$15.97	4
	Solder/Solder	RG188-DS, RG316-DS	PE44417	\$18.80	\$17.48	\$16.17	\$15.04	5
		PE-034SR, .034" Semi-Rigid	PE44440	\$22.34	\$20.78	\$19.21	\$17.87	6
		PE-047SR, PE-SR047AL, PE-SR047FL, .047" Semi-Rigid	PE44441	\$22.34	\$20.78	\$19.21	\$17.87	7
		PE-SR405AL, PE-SR405FL, RG405, .085" Semi-Rigid	PE44383	\$24.88	\$23.14	\$21.40	\$19.90	8
		RG174, RG316, RG188	PE4184	\$19.30	\$17.95	\$16.60	\$15.44	9
		RG178, RG196	PE4199	\$22.30	\$20.74	\$19.18	\$17.84	10
	Solder (Without Contact)	PE-SR405AL, PE-SR405FL, RG405, .085" Semi-Rigid	PE44382	\$21.13	\$19.65	\$18.17	\$16.90	11

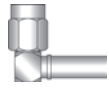
<b>Male Right Angle, Cable Connectors</b>								
	Crimp/Solder	RG188-DS, RG316-DS	PE44418	\$22.80	\$21.20	\$19.61	\$18.24	12
		RG174, RG316, RG188	PE44378	\$21.13	\$19.65	\$18.17	\$16.90	13
		RG178, RG196	PE44380	\$41.75	\$38.83	\$35.91	\$33.40	14
	Solder/Solder	RG188-DS, RG316-DS	PE44419	\$22.30	\$20.74	\$19.18	\$17.84	15
		PE-034SR, .034" Semi-Rigid	PE44420	\$34.86	\$32.42	\$29.98	\$27.89	16
		PE-047SR, PE-SR047AL, PE-SR047FL, .047" Semi-Rigid	PE44421	\$34.86	\$32.42	\$29.98	\$27.89	17
		PE-SR405AL, PE-SR405FL, RG405, .085" Semi-Rigid	PE44384	\$24.88	\$23.14	\$21.40	\$19.90	18
		RG174, RG316, RG188	PE44401	\$26.75	\$24.88	\$23.01	\$21.40	19
		RG178, RG196	PE44402	\$22.30	\$20.74	\$19.18	\$17.84	20

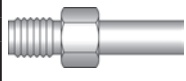
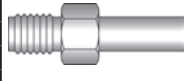
<b>Female Straight, Cable Connectors</b>								
	Crimp/Solder	RG188-DS, RG316-DS	PE44422	\$21.20	\$19.72	\$18.23	\$16.96	21
		RG174, RG316, RG188	PE44385	\$21.68	\$20.16	\$18.64	\$17.34	22
		RG178, RG196	PE44386	\$37.19	\$34.59	\$31.98	\$29.75	23
	Solder/Solder	RG188-DS, RG316-DS	PE44423	\$22.30	\$20.74	\$19.18	\$17.84	24
		PE-034SR, .034" Semi-Rigid	PE44424	\$27.31	\$25.40	\$23.49	\$21.85	25
		PE-047SR, PE-SR047AL, PE-SR047FL, .047" Semi-Rigid	PE44425	\$26.04	\$24.22	\$22.39	\$20.83	26
		PE-SR405AL, PE-SR405FL, RG405, .085" Semi-Rigid	PE44387	\$20.77	\$19.32	\$17.86	\$16.62	27
		RG174, RG316, RG188	PE44403	\$20.05	\$18.65	\$17.24	\$16.04	28
		RG178, RG196	PE44404	\$20.05	\$18.65	\$17.24	\$16.04	29

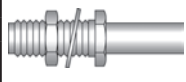
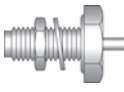
<b>Female Straight, Bulkhead Mount, Cable Connectors</b>								
	Crimp/Solder	RG188-DS, RG316-DS	PE44426	\$22.30	\$20.74	\$19.18	\$17.84	30
		RG174, RG316, RG188	PE44388	\$29.74	\$27.66	\$25.58	\$23.79	31
		RG178, RG196	PE44389	\$25.60	\$23.81	\$22.02	\$20.48	32
	Solder/Solder	RG188-DS, RG316-DS	PE44427	\$21.20	\$19.72	\$18.23	\$16.96	33
		PE-034SR, .034" Semi-Rigid	PE44428	\$33.79	\$31.42	\$29.06	\$27.03	34
		PE-047SR, PE-SR047AL, PE-SR047FL, .047" Semi-Rigid	PE44429	\$33.79	\$31.42	\$29.06	\$27.03	35
		PE-SR405AL, PE-SR405FL, RG405, .085" Semi-Rigid	PE44390	\$23.66	\$22.00	\$20.35	\$18.93	36
		RG174, RG316, RG188	PE44405	\$21.20	\$19.72	\$18.23	\$16.96	37
		RG178, RG196	PE44406	\$21.20	\$19.72	\$18.23	\$16.96	38







Connectors

See Our Website For Real-Time Stock Availability!

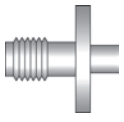
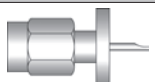
# SSMA Connectors

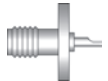
Connectors



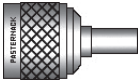

See Our Website For Real-Time Stock Availability!

Product Image	Attachment Cable/Contact	Coax Type / Termination Type	Model No.	Price				Row
				1-24	25-49	50-99	100 +	
<b>Female Straight, Panel Mount, Cable Connectors</b>								
	Solder/Solder	2 Hole Flange, PE-047SR, PE-SR047AL, PE-SR047FL, C07 Mounting Hole, .047" Semi-Rigid	PE44436	\$27.31	\$25.40	\$23.49	\$21.85	1
		2 Hole Flange, PE-SR405AL, PE-SR405FL, RG405, C07 Mounting Hole, .085" Semi-Rigid	PE44437	\$29.94	\$27.84	\$25.75	\$23.95	2
		4 Hole Flange, PE-047SR, PE-SR047AL, PE-SR047FL, A22 Mounting Hole, .047" Semi-Rigid	PE44438	\$35.77	\$33.27	\$30.76	\$28.62	3
		4 Hole Flange, PE-SR405AL, PE-SR405FL, RG405, A22 Mounting Hole, .085" Semi-Rigid	PE44439	\$31.11	\$28.93	\$26.75	\$24.89	4
<b>Male Straight, Panel Mount, Terminal</b>								
	Solder	2 Hole Flange, Solder Cup Contact, C07 Mounting Hole	PE44431	\$24.88	\$23.14	\$21.40	\$19.90	5
		4 Hole Flange, Solder Cup Contact, A22 Mounting Hole	PE44432	\$24.88	\$23.14	\$21.40	\$19.90	6
<b>Female Straight, Bulkhead Mount, Terminal</b>								
	Solder	Solder Cup Contact, Rear Mount, .130" Max Panel, B01 Mounting Hole	PE44393	\$23.13	\$21.51	\$19.89	\$18.50	7
		Turret, .050" Dia. Contact, Front Mount, .093" Max Panel, B01 Mounting Hole	PE44392	\$24.88	\$23.14	\$21.40	\$19.90	8
<b>Female Straight, Panel Mount, Terminal</b>								
	Solder	2 Hole Flange, .034" Dia. Stub Contact, .375" Extended Dielectric, C07 Mounting Hole	PE44433	\$34.40	\$31.99	\$29.58	\$27.52	9
		2 Hole Flange, Solder Cup Contact, C07 Mounting Hole	PE44395	\$24.88	\$23.14	\$21.40	\$19.90	10
		4 Hole Flange, .034" Dia. Stub Contact, .375" Extended Dielectric, A22 Mounting Hole	PE44434	\$30.40	\$28.27	\$26.14	\$24.32	11
		4 Hole Flange, Solder Cup Contact, A22 Mounting Hole	PE44394	\$27.36	\$25.44	\$23.53	\$21.89	12
<b>Male Straight, PCB Mount</b>								
	Solder	.034" Dia Contact, .155" Leg Length, Thru Hole, D02 Mounting Hole	PE44430	\$19.40	\$18.04	\$16.68	\$15.52	13
<b>Female Straight, PCB Mount</b>								
	Solder	.034" Dia. Contact, .155" Leg Length, Thru Hole, D02 Mounting Hole	PE44391	\$23.56	\$21.91	\$20.26	\$18.85	14
<b>Female Right Angle, PCB Mount</b>								
	Solder	.034" Dia. Contact, .155" Leg Length, Thru Hole, D02 Mounting Hole	PE44435	\$34.00	\$31.62	\$29.24	\$27.20	15

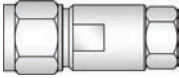

# N Connectors

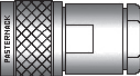
Product Image	Attachment Cable/Contact	Coax Type / Termination Type	Model No.	Price				Row
				1-24	25-49	50-99	100 +	
<b>Male Straight, Cable Connectors</b>								
	Crimp/Solder	RG8X, PE-C240	PE4344	\$16.57	\$15.41	\$14.25	\$13.26	16
		PE-B400, PE-B405, PE-C400	PE4550	\$11.50	\$10.70	\$9.89	\$9.20	17
		PE-C195	PE44520	\$11.25	\$10.46	\$9.68	\$9.00	18
		PE-C200	PE44044	\$11.75	\$10.93	\$10.11	\$9.40	19
		PE-C240, Hex Nut	PE44521	\$11.25	\$10.46	\$9.68	\$9.00	20
		PE-C400, Hex Nut	PE44522	\$12.16	\$11.31	\$10.46	\$9.73	21
		PE-C600	PE44454	\$41.70	\$38.78	\$35.86	\$33.36	22
		PE-C600	PE44523	\$22.50	\$20.93	\$19.35	\$18.00	23
		RG174, RG316, RG188	PE4429	\$12.77	\$11.88	\$10.98	\$10.22	24
		RG178, RG196	PE4647	\$21.13	\$19.65	\$18.17	\$16.90	25
		RG213, RG8	PE4430	\$12.50	\$11.63	\$10.75	\$10.00	26
		RG214, RG9, RG225, RG393	PE4048	\$12.69	\$11.80	\$10.91	\$10.15	27
		RG58	PE4329	\$10.80	\$10.04	\$9.29	\$8.64	28
		RG59, RG62	PE4432	\$10.99	\$10.22	\$9.45	\$8.79	29
		RG55, RG141, RG142, RG223, RG400	PE4042	\$11.96	\$11.12	\$10.29	\$9.57	30



# N Connectors

Product Image	Attachment Cable/Contact	Coax Type / Termination Type	Model No.	Price				Row
				1-24	25-49	50-99	100 +	
	Clamp	1/4 inch Super Flexible, Precision, Low PIM	PE44726	\$36.21	\$33.68	\$31.14	\$28.97	1
		1/2 inch Flexible, Precision, Low PIM	PE44735	\$27.83	\$25.88	\$23.93	\$22.26	2
		1/2 inch Super Flexible, Precision, Low PIM	PE44729	\$27.83	\$25.88	\$23.93	\$22.26	3
	Clamp/Solder	RG8X, PE-C240	PE4431	\$10.60	\$9.86	\$9.12	\$8.48	4
		PE-B400, PE-B405, PE-C400	PE4133	\$14.08	\$13.09	\$12.11	\$11.26	5
		PE-C200	PE44043	\$10.60	\$9.86	\$9.12	\$8.48	6
		PE-C300	PE44045	\$15.95	\$14.83	\$13.72	\$12.76	7
		PE-C500	PE44046	\$24.72	\$22.99	\$21.26	\$19.78	8
		PE-C600	PE44349	\$46.87	\$43.59	\$40.31	\$37.50	9
		PE-SR401AL, PE-SR401FL, RG401, .250" Semi-Rigid	PE4434	\$15.35	\$14.28	\$13.20	\$12.28	10
		PE-SR402AL, PE-SR402FL, RG402, .141" Semi-Rigid	PE4006	\$15.35	\$14.28	\$13.20	\$12.28	11
		PE-SR405AL, PE-SR405FL, RG405, .085" Semi-Rigid	PE4129	\$15.35	\$14.28	\$13.20	\$12.28	12
		1/2" Helical, Low PIM	PE44552	\$47.73	\$44.39	\$41.05	\$38.18	13
		1/2" Annular, Low PIM	PE44562	\$47.73	\$44.39	\$41.05	\$38.18	14
		7/8" Annular, Low PIM	PE44563	\$59.63	\$55.46	\$51.28	\$47.70	15
		7/8" Helical, Low PIM	PE44553	\$59.63	\$55.46	\$51.28	\$47.70	16
		RG14, RG217	PE4221	\$23.36	\$21.72	\$20.09	\$18.69	17
		RG174, RG316, RG188	PE4224	\$12.95	\$12.04	\$11.14	\$10.36	18
		RG213, RG214, RG8, RG9, RG225, RG393, RG11	PE4062	\$11.07	\$10.30	\$9.52	\$8.86	19
		RG218	PE4433	\$70.68	\$65.73	\$60.78	\$56.54	20
		RG58, RG55, RG141, RG142, RG400, RG223	PE4081	\$8.61	\$8.01	\$7.40	\$6.89	21
		RG59, RG62	PE4331	\$12.92	\$12.02	\$11.11	\$10.34	22
			Clamp/Solder (Captive Contact)	RG213, RG214, RG8, RG9, RG225, RG393, RG11	PE4132	\$12.59	\$11.71	\$10.83
	Solder/Solder	PE-047SR, PE-SR047AL, PE-SR047FL, .047" Semi-Rigid	PE4934	\$24.72	\$22.99	\$21.26	\$19.78	24
		PE-SR401AL, PE-SR401FL, RG401, Precision, .250" Semi-Rigid	PE4376	\$31.92	\$29.69	\$27.45	\$25.54	25
		PE-SR402AL, PE-SR402FL, RG402, Precision, .141" Semi-Rigid	PE4140	\$18.39	\$17.10	\$15.82	\$14.71	26
		PE-SR405AL, PE-SR405FL, RG405, Precision, .085" Semi-Rigid	PE4222	\$28.22	\$26.24	\$24.27	\$22.58	27

## Male Right Angle, Cable Connectors

	Crimp/Solder	PE-B400, PE-B405, PE-C400	PE4939	\$32.45	\$30.18	\$27.91	\$25.96	28
		PE-C100, RG174, RG316	PE44675	\$20.42	\$18.99	\$17.56	\$16.34	29
		PE-C195	PE44524	\$21.38	\$19.88	\$18.39	\$17.10	30
		PE-C240	PE44525	\$23.81	\$22.14	\$20.48	\$19.05	31
		PE-C400, Hex Nut	PE44526	\$28.12	\$26.15	\$24.18	\$22.50	32
		PE-C600	PE44527	\$41.60	\$38.69	\$35.78	\$33.28	33
		RG213, RG8	PE4482	\$27.65	\$25.71	\$23.78	\$22.12	34
		RG214, RG9, RG225, RG393	PE4483	\$31.42	\$29.22	\$27.02	\$25.14	35
		RG58	PE4485	\$20.45	\$19.02	\$17.59	\$16.36	36
		RG55, RG141, RG142, RG223, RG400	PE4484	\$22.61	\$21.03	\$19.44	\$18.09	37
	Clamp/Solder	PE-B400, PE-B405, PE-C400	PE4938	\$21.20	\$19.72	\$18.23	\$16.96	38
		PE-SR401AL, PE-SR401FL, RG401, .250" Semi-Rigid	PE4935	\$22.75	\$21.16	\$19.57	\$18.20	39
		1/2" Helical, Low PIM	PE44554	\$54.87	\$51.03	\$47.19	\$43.90	40
		1/2" Annular, Low PIM	PE44564	\$58.47	\$54.38	\$50.28	\$46.78	41
		RG213, RG214, RG8, RG9, RG393, RG225	PE4136	\$18.39	\$17.10	\$15.82	\$14.71	42
		RG58, RG55, RG141, RG142, RG400, RG223	PE4135	\$15.96	\$14.84	\$13.73	\$12.77	43
	Solder/Solder	PE-SR402AL, PE-SR402FL, RG402, .141" Semi-Rigid	PE4936	\$18.19	\$16.92	\$15.64	\$14.55	44
		PE-SR405AL, PE-SR405FL, RG405, .085" Semi-Rigid	PE4937	\$19.91	\$18.52	\$17.12	\$15.93	45

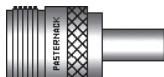
## Female Straight, Cable Connectors

	Crimp/Solder	PE-C195	PE44532	\$14.24	\$13.24	\$12.25	\$11.39	46
		PE-C240	PE44533	\$14.24	\$13.24	\$12.25	\$11.39	47
		PE-C400	PE44534	\$17.88	\$16.63	\$15.38	\$14.30	48
		PE-C600	PE44535	\$35.77	\$33.27	\$30.76	\$28.62	49
		RG174, RG316, RG188	PE4438	\$15.96	\$14.84	\$13.73	\$12.77	50
		RG213, RG8	PE4435	\$11.90	\$11.07	\$10.23	\$9.52	51
		RG214, RG9, RG225, RG393	PE4191	\$13.07	\$12.16	\$11.24	\$10.46	52
		RG58	PE4436	\$11.90	\$11.07	\$10.23	\$9.52	53
RG55, RG141, RG142, RG223, RG400	PE4134	\$12.31	\$11.45	\$10.59	\$9.85	54		
	Clamp	1/4 inch Super Flexible, Precision, Low PIM	PE44727	\$36.21	\$33.68	\$31.14	\$28.97	55
		1/2 inch Flexible, Precision, Low PIM	PE44737	\$27.83	\$25.88	\$23.93	\$22.26	56
		1/2 inch Super Flexible, Precision, Low PIM	PE44731	\$27.83	\$25.88	\$23.93	\$22.26	57

Connectors

See Our Website For Real-Time Stock Availability!









# N Connectors

Connectors

See Our Website For Real-Time Stock Availability!

Product Image	Attachment Cable/Contact	Coax Type / Termination Type	Model No.	Price				Row
				1-24	25-49	50-99	100 +	
	Clamp/Solder	PE-B400, PE-B405, PE-C400	PE4372	\$21.28	\$19.79	\$18.30	\$17.02	1
		PE-C600	PE44350	\$56.04	\$52.12	\$48.19	\$44.83	2
		PE-SR401AL, PE-SR401FL, RG401, .250" Semi-Rigid	PE4439	\$17.95	\$16.69	\$15.44	\$14.36	3
		PE-SR402AL, PE-SR402FL, RG402, .141" Semi-Rigid	PE4138	\$15.35	\$14.28	\$13.20	\$12.28	4
		PE-SR405AL, PE-SR405FL, RG405, .085" Semi-Rigid	PE4130	\$15.60	\$14.51	\$13.42	\$12.48	5
		1/2" Helical, Low PIM	PE44555	\$47.73	\$44.39	\$41.05	\$38.18	6
		1/2" Annular, Low PIM	PE44565	\$59.63	\$55.46	\$51.28	\$47.70	7
		7/8" Annular, Low PIM	PE44566	\$59.63	\$55.46	\$51.28	\$47.70	8
		7/8" Helical, Low PIM	PE44556	\$59.63	\$55.46	\$51.28	\$47.70	9
		RG14, RG217	PE4645	\$45.60	\$42.41	\$39.22	\$36.48	10
		RG174, RG316, RG188	PE4437	\$14.75	\$13.72	\$12.69	\$11.80	11
		RG213, RG214, RG8, RG9, RG225, RG393, RG11	PE4061	\$12.92	\$12.02	\$11.11	\$10.34	12
		RG218	PE4646	\$46.05	\$42.83	\$39.60	\$36.84	13
		RG58, RG55, RG141, RG142, RG400, RG223	PE4072	\$12.31	\$11.45	\$10.59	\$9.85	14
RG59, RG62	PE4330	\$12.46	\$11.59	\$10.72	\$9.97	15		
	Clamp/Solder (Captive Contact)	RG213, RG214, RG8, RG9, RG225, RG393, RG11	PE4059	\$20.16	\$18.75	\$17.34	\$16.13	16
	Solder/Solder	PE-047SR, PE-SR047AL, PE-SR047FL, Precision, .047" Semi-Rigid	PE4945	\$49.91	\$46.42	\$42.92	\$39.93	17
		PE-SR402AL, PE-SR402FL, RG402, Precision, .141" Semi-Rigid	PE4652	\$24.34	\$22.64	\$20.93	\$19.47	18
		PE-SR405AL, PE-SR405FL, RG405, Precision, .085" Semi-Rigid	PE4653	\$22.34	\$20.78	\$19.21	\$17.87	19

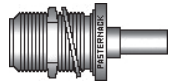





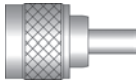
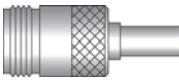

## Female Straight, Bulkhead Mount, Cable Connectors

	Crimp/Solder	PE-B400, PE-B405, PE-C400, G01 Mounting Hole	PE4944	\$22.75	\$21.16	\$19.57	\$18.20	20
		PE-C195, G01 Mounting Hole	PE44528	\$13.07	\$12.16	\$11.24	\$10.46	21
		PE-C240, G01 Mounting Hole	PE44529	\$12.31	\$11.45	\$10.59	\$9.85	22
		PE-C400, White Bronze, G01 Mounting Hole	PE44530	\$16.87	\$15.69	\$14.51	\$13.50	23
		PE-C600, G01 Mounting Hole	PE44531	\$29.79	\$27.70	\$25.62	\$23.83	24
		RG174, RG316, RG188, G01 Mounting Hole	PE4442	\$20.82	\$19.36	\$17.91	\$16.66	25
		RG213, RG8, G01 Mounting Hole	PE4940	\$22.75	\$21.16	\$19.57	\$18.20	26
		RG214, RG9, RG225, RG393, G01 Mounting Hole	PE4941	\$22.95	\$21.34	\$19.74	\$18.36	27
		RG58, G01 Mounting Hole	PE4440	\$13.15	\$12.23	\$11.31	\$10.52	28
		RG55, RG141, RG142, RG223, RG400, G01 Mounting Hole	PE4371	\$14.90	\$13.86	\$12.81	\$11.92	29
	Clamp/Solder	PE-B400, PE-B405, PE-C400, G01 Mounting Hole	PE4943	\$18.60	\$17.30	\$16.00	\$14.88	30
		PE-SR401AL, PE-SR401FL, RG401, G01 Mounting Hole, .250" Semi-Rigid	PE4942	\$19.10	\$17.76	\$16.43	\$15.28	31
		PE-SR402AL, PE-SR402FL, RG402, G01 Mounting Hole, .141" Semi-Rigid	PE4113	\$15.60	\$14.51	\$13.42	\$12.48	32
		PE-SR405AL, PE-SR405FL, RG405, G01 Mounting Hole, .085" Semi-Rigid	PE4443	\$15.35	\$14.28	\$13.20	\$12.28	33
		RG174, RG316, RG188, G01 Mounting Hole	PE4441	\$16.65	\$15.48	\$14.32	\$13.32	34
		RG178, G01 Mounting Hole	PE44633	\$16.65	\$15.48	\$14.32	\$13.32	35
		RG213, RG214, RG8, RG9, RG225, RG393, RG11, G01 Mounting Hole	PE4223	\$18.39	\$17.10	\$15.82	\$14.71	36
		RG58, RG55, RG141, RG142, RG400, RG223, G01 Mounting Hole	PE4114	\$14.90	\$13.86	\$12.81	\$11.92	37
		RG59, RG62, G01 Mounting Hole	PE4297	\$23.66	\$22.00	\$20.35	\$18.93	38
			Solder/Solder	PE-047SR, PE-SR047AL, PE-SR047FL, Precision, G01 Mounting Hole, .047" Semi-Rigid	PE4946	\$43.52	\$40.47	\$37.43
PE-SR402AL, PE-SR402FL, RG402, Precision, G01 Mounting Hole, .141" Semi-Rigid	PE4654			\$25.44	\$23.66	\$21.88	\$20.35	40
PE-SR405AL, PE-SR405FL, RG405 Precision, G01 Mounting Hole, .085" Semi-Rigid	PE4655			\$26.75	\$24.88	\$23.01	\$21.40	41

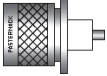
## Female Straight, Panel Mount, Cable Connectors

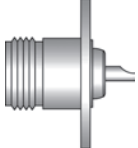
	Crimp/Solder	4 Hole Flange, RG213, RG8, A05 Mounting Hole	PE44065	\$16.75	\$15.58	\$14.41	\$13.40	42
		4 Hole Flange, RG214, RG9, RG225, RG393, A05 Mounting Hole	PE44066	\$18.24	\$16.96	\$15.69	\$14.59	43
		4 Hole Flange, RG58, A05 Mounting Hole	PE44069	\$17.73	\$16.49	\$15.25	\$14.18	44
		4 Hole Flange, RG55, RG141, RG142, RG223, RG400, A05 Mounting Hole	PE44068	\$17.07	\$15.88	\$14.68	\$13.66	45
	Clamp/Solder	4 Hole Flange, PE-SR401AL, PE-SR401FL, RG401, A05 Mounting Hole, .250" Semi-Rigid	PE44071	\$19.10	\$17.76	\$16.43	\$15.28	46
		4 Hole Flange, PE-SR402AL, PE-SR402FL, RG402, A05 Mounting Hole, .141" Semi-Rigid	PE44072	\$19.10	\$17.76	\$16.43	\$15.28	47
		4 Hole Flange, PE-SR405AL, PE-SR405FL, RG405, A05 Mounting Hole, .085" Semi-Rigid	PE44073	\$18.80	\$17.48	\$16.17	\$15.04	48
		4 Hole Flange, RG174, RG316, RG188, A05 Mounting Hole	PE44070	\$14.35	\$13.35	\$12.34	\$11.48	49
		4 Hole Flange, RG58, RG55, RG141, RG142, RG400, RG223, A05 Mounting Hole	PE4141	\$12.21	\$11.36	\$10.50	\$9.77	50
	Clamp/Solder (Captive Contact)	4 Hole Flange, RG213, RG214, RG8, RG9, RG225, RG393, RG11, A05 Mounting Hole	PE4060	\$19.09	\$17.75	\$16.42	\$15.27	51

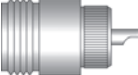
# N Connectors

Product Image	Attachment Cable/Contact	Coax Type / Termination Type	Model No.	Price				Row
				1-24	25-49	50-99	100 +	
<b>Reverse Polarity Male Straight, Cable Connectors</b>								
	Crimp/Solder	PE-B400, PE-B405, PE-C400	PE44470	\$23.66	\$22.00	\$20.35	\$18.93	1
		RG213, RG8	PE44472	\$23.66	\$22.00	\$20.35	\$18.93	2
		RG214, RG393, RG9, RG225	PE44474	\$21.60	\$20.09	\$18.58	\$17.28	3
		RG58	PE44473	\$20.50	\$19.07	\$17.63	\$16.40	4
		RG55, RG141, RG142, RG223, RG400	PE44471	\$25.74	\$23.94	\$22.14	\$20.59	5
<b>Reverse Polarity Female Straight, Cable Connectors</b>								
	Crimp/Solder	RG213, RG8	PE44478	\$20.50	\$19.07	\$17.63	\$16.40	6
		RG214, RG9, RG225, RG393	PE44477	\$22.34	\$20.78	\$19.21	\$17.87	7
		RG58	PE44476	\$20.50	\$19.07	\$17.63	\$16.40	8
		RG55, RG141, RG142, RG223, RG400	PE44475	\$22.34	\$20.78	\$19.21	\$17.87	9
<b>Male Straight, Bulkhead Mount, Terminal</b>								
	Solder	Solder Cup Contact, Front Mount, G01 Mounting Hole	PE4489	\$26.14	\$24.31	\$22.48	\$20.91	10
		Solder Cup Contact, Front Mount, B04 Mounting Hole	PE4490	\$25.03	\$23.28	\$21.53	\$20.02	11
<b>Male Straight, Panel Mount, Terminal</b>								
	Solder	4 Hole Flange, .050" Dia. Contact, .590" Extended Dielectric, A05 Mounting Hole	PE44653	\$54.82	\$50.98	\$47.15	\$43.86	12
		4 Hole Flange, .120" Dia Stub Contact, .330 Extended Dielectric, A05 Mounting Hole	PE4491	\$23.00	\$21.39	\$19.78	\$18.40	13
		4 Hole Flange, Solder Cup Contact, A05 Mounting Hole	PE4131	\$11.38	\$10.58	\$9.79	\$9.10	14
<b>Female Straight, Bulkhead Mount, Terminal</b>								
	Solder	.120" Half Moon Contact, Rear Mount, .325" Max Panel, G01 Mounting Hole	PE4139	\$8.56	\$7.96	\$7.36	\$6.85	15
		Solder Cup Contact, Front Mount, F05 Mounting Hole	PE4488	\$10.99	\$10.22	\$9.45	\$8.79	16
		Solder Cup Contact, Front Mount, Hermetically Sealed, G01 Mounting Hole	PE4137	\$12.72	\$11.83	\$10.94	\$10.18	17
<b>Female Straight, Panel Mount, Terminal</b>								
	Solder	2 Hole Flange, .005" X .120" Tab Contact, C04 Mounting Hole	PE44078	\$20.77	\$19.32	\$17.86	\$16.62	18
		2 Hole Flange, .050" Dia. Stub Contact, .590" Extended Dielectric, C04 Mounting Hole	PE44079	\$33.74	\$31.38	\$29.02	\$26.99	19
		2 Hole Flange, Solder Cup Contact, C04 Mounting Hole	PE44077	\$19.40	\$18.04	\$16.68	\$15.52	20
		4 Hole Flange, .100" X .120" Tab Contact, A05 Mounting Hole	PE4492	\$18.75	\$17.44	\$16.13	\$15.00	21
		4 Hole Flange, .050" Dia. Stub Contact, .590" Extended Dielectric, .500" Flange Size, A01 Mounting Hole	PE4355	\$14.69	\$13.66	\$12.63	\$11.75	22
		4 Hole Flange, .120" Dia Stub Contact, .590" Extended Dielectric, A05 Mounting Hole	PE4328	\$14.44	\$13.43	\$12.42	\$11.55	23
		4 Hole Flange, .050" Dia. Stub Contact, .590" Extended Dielectric, .687" Flange Size, A04 Mounting Hole	PE4444	\$16.26	\$15.12	\$13.98	\$13.01	24
		4 Hole Flange, Solder Cup Contact, A05 Mounting Hole	PE4013	\$9.53	\$8.86	\$8.20	\$7.62	25
		4 Hole Flange, Solder Cup Contact, Hermetically Sealed w/o-ring, A05 Mounting Hole	PE4487	\$41.14	\$38.26	\$35.38	\$32.91	26
<b>Female Right Angle, Panel Mount, Terminal</b>								
	Solder	4 Hole Flange, Solder Cup Contact, A05 Mounting Hole	PE4486	\$34.86	\$32.42	\$29.98	\$27.89	27
<b>Female Straight, Press In Mount, Terminal</b>								
	Solder	.005" X .120" Tab Contact, F02 Mounting Hole	PE44075	\$22.34	\$20.78	\$19.21	\$17.87	28
		.050" Dia. Stub Contact, F02 Mounting Hole	PE44074	\$19.91	\$18.52	\$17.12	\$15.93	29
		Solder Cup Contact, F02 Mounting Hole	PE44076	\$11.60	\$10.79	\$9.98	\$9.28	30
<b>Female Straight, PCB Mount</b>								
	Solder	Surface Mount Edge Launch, G01 Mounting Hole	PE44615	\$21.33	\$19.84	\$18.34	\$17.06	31
		.050" Dia. Contact, .155" Leg Length, Thru Hole, D12 Mounting Hole	PE44396	\$18.75	\$17.44	\$16.13	\$15.00	32

Connectors





See Our Website For Real-Time Stock Availability!

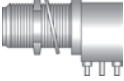

# N Connectors

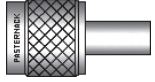
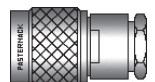
Product Image	Attachment Cable/Contact	Coax Type / Termination Type	Model No.	Price				Row
				1-24	25-49	50-99	100 +	
<b>Female Straight, Bulkhead Mount, PCB Mount</b>								
	Solder	.062" Dia. Contact, .125" Leg Length, .700" Max Panel, Thru Hole, D12 & G01 Mounting Hole	PE44397	\$24.88	\$23.14	\$21.40	\$19.90	1
<b>Female Right Angle, Bulkhead Mount, PCB Mount</b>								
	Solder	.062" Dia. Contact, .125" Leg Length, .350" Max Panel, Thru Hole, D12 & B15 Mounting Hole	PE44398	\$19.71	\$18.33	\$16.95	\$15.77	2



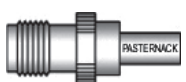
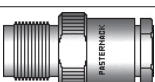



# TNC Connectors

Product Image	Attachment Cable/Contact	Coax Type / Termination Type	Model No.	Price				Row
				1-24	25-49	50-99	100 +	
<b>Male Straight, Cable Connectors</b>								
	Crimp/Solder	RG8X, PE-C240	PE44634	\$10.74	\$9.99	\$9.24	\$8.59	3
		PE-B400, PE-B405, PE-C400	PE44293	\$23.15	\$21.53	\$19.91	\$18.52	4
		PE-C200	PE44062	\$13.15	\$12.23	\$11.31	\$10.52	5
		RG174, RG316, RG188	PE4302	\$15.20	\$14.14	\$13.07	\$12.16	6
		RG213, RG8	PE4446	\$14.35	\$13.35	\$12.34	\$11.48	7
		RG214, RG9, RG225, RG393	PE4447	\$20.61	\$19.17	\$17.72	\$16.49	8
		RG58	PE4156	\$8.35	\$7.77	\$7.18	\$6.68	9
		RG59, RG62	PE4071	\$8.61	\$8.01	\$7.40	\$6.89	10
	Clamp/Solder	RG55, RG141, RG142, RG223, RG400	PE4047	\$10.18	\$9.47	\$8.75	\$8.14	11
		RG8X, PE-C240	PE44063	\$13.43	\$12.49	\$11.55	\$10.74	12
		PE-B400, PE-B405, PE-C400	PE4449	\$15.96	\$14.84	\$13.73	\$12.77	13
		PE-C200	PE44061	\$13.15	\$12.23	\$11.31	\$10.52	14
		PE-C300	PE44064	\$14.35	\$13.35	\$12.34	\$11.48	15
		PE-SR402AL, PE-SR402FL, RG402, .141" Semi-Rigid	PE4143	\$16.45	\$15.30	\$14.15	\$13.16	16
		PE-SR405AL, PE-SR405FL, RG405, .085" Semi-Rigid	PE4142	\$16.45	\$15.30	\$14.15	\$13.16	17
		RG174, RG316, RG188	PE4303	\$11.70	\$10.88	\$10.06	\$9.36	18
		RG178, RG196	PE4448	\$14.35	\$13.35	\$12.34	\$11.48	19
		RG213, RG214, RG8, RG9, RG225, RG393, RG11	PE4088	\$13.98	\$13.00	\$12.02	\$11.18	20
		RG58, RG55, RG141, RG142, RG400, RG223	PE4067	\$18.62	\$17.32	\$16.01	\$14.90	21
RG59, RG62	PE4154	\$11.30	\$10.51	\$9.72	\$9.04	22		
	Solder/Solder	PE-047SR, PE-SR047AL, PE-SR047FL, .047" Semi-Rigid	PE4975	\$20.77	\$19.32	\$17.86	\$16.62	23
		PE-SR401AL, PE-SR401FL, RG401, .250" Semi-Rigid	PE4909	\$46.05	\$42.83	\$39.60	\$36.84	24
		PE-SR402AL, PE-SR402FL, RG402, .141" Semi-Rigid	PE4648	\$22.24	\$20.68	\$19.13	\$17.79	25
		PE-SR405AL, PE-SR405FL, RG405, .085" Semi-Rigid	PE4649	\$20.87	\$19.41	\$17.95	\$16.70	26
<b>Male Right Angle, Cable Connectors</b>								
	Crimp/Solder	RG8X, PE-C240	PE44635	\$19.25	\$17.90	\$16.56	\$15.40	27
		RG174, RG316, RG188	PE4455	\$19.04	\$17.71	\$16.37	\$15.23	28
		RG58	PE4451	\$18.36	\$17.07	\$15.79	\$14.69	29
		RG59, RG62	PE4453	\$18.24	\$16.96	\$15.69	\$14.59	30
	Clamp/Solder	RG55, RG141, RG142, RG223, RG400	PE4450	\$20.50	\$19.07	\$17.63	\$16.40	31
		RG174, RG316, RG188	PE4454	\$16.75	\$15.58	\$14.41	\$13.40	32
		RG178, RG196	PE4456	\$20.45	\$19.02	\$17.59	\$16.36	33
		RG213, RG214, RG8, RG9, RG225, RG393, RG11	PE4146	\$25.38	\$23.60	\$21.83	\$20.30	34
		RG58, RG55, RG141, RG142, RG400, RG223	PE4054	\$19.66	\$18.28	\$16.91	\$15.73	35
RG59, RG62	PE4452	\$25.84	\$24.03	\$22.22	\$20.67	36		
<b>Female Straight, Cable Connectors</b>								
	Crimp/Solder	RG8X, PE-C240	PE44636	\$12.87	\$11.97	\$11.07	\$10.30	37
		RG174, RG316, RG188	PE4462	\$14.08	\$13.09	\$12.11	\$11.26	38
		RG58	PE4458	\$11.17	\$10.39	\$9.61	\$8.94	39
		RG59, RG62	PE4459	\$11.60	\$10.79	\$9.98	\$9.28	40
	Clamp/Solder	RG55, RG141, RG142, RG223, RG400	PE4457	\$11.35	\$10.56	\$9.76	\$9.08	41
		PE-SR402AL, PE-SR402FL, RG402, .141" Semi-Rigid	PE4145	\$16.75	\$15.58	\$14.41	\$13.40	42

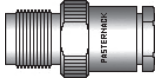
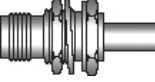
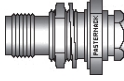
Connectors

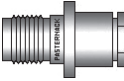
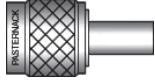
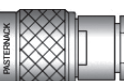
See Our Website For Real-Time Stock Availability!

# TNC Connectors

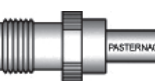
Product Image	Attachment Cable/Contact	Coax Type / Termination Type	Model No.	Price				Row
				1-24	25-49	50-99	100 +	
	Clamp/Solder	PE-SR405AL, PE-SR405FL, RG405, .085" Semi-Rigid	PE4144	\$16.75	\$15.58	\$14.41	\$13.40	1
		RG174, RG316, RG188	PE4461	\$11.70	\$10.88	\$10.06	\$9.36	2
		RG178, RG196	PE4463	\$13.15	\$12.23	\$11.31	\$10.52	3
		RG213, RG214, RG8, RG9, RG225, RG393, RG11	PE4155	\$25.84	\$24.03	\$22.22	\$20.67	4
		RG58, RG55, RG141, RG142, RG400, RG223	PE4068	\$9.58	\$8.91	\$8.24	\$7.66	5
		RG59, RG62	PE4460	\$11.60	\$10.79	\$9.98	\$9.28	6
<b>Female Straight, Bulkhead Mount, Cable Connectors</b>								
	Crimp/Solder	RG174, RG316, RG188, B06 Mounting Hole	PE4466	\$18.67	\$17.36	\$16.06	\$14.94	7
		RG58, B06 Mounting Hole	PE4151	\$14.14	\$13.15	\$12.16	\$11.31	8
		RG59, RG62, B06 Mounting Hole	PE4465	\$18.24	\$16.96	\$15.69	\$14.59	9
		RG55, RG141, RG142, RG223, RG400, B06 Mounting Hole	PE4153	\$14.75	\$13.72	\$12.69	\$11.80	10
	Clamp/Solder	PE-SR402AL, PE-SR402FL, RG402, B06 Mounting Hole, .141" Semi-Rigid	PE4150	\$20.05	\$18.65	\$17.24	\$16.04	11
		PE-SR405AL, PE-SR405FL, RG405, B06 Mounting Hole, .085" Semi-Rigid	PE4149	\$20.05	\$18.65	\$17.24	\$16.04	12
		RG174, RG316, RG188, B06 Mounting Hole	PE4304	\$16.45	\$15.30	\$14.15	\$13.16	13
		RG178, RG196, B06 Mounting Hole	PE4467	\$16.75	\$15.58	\$14.41	\$13.40	14
		RG58, RG55, RG141, RG142, RG400, RG223, B06 Mounting Hole	PE4152	\$14.69	\$13.66	\$12.63	\$11.75	15
		RG59, RG62, B06 Mounting Hole	PE4464	\$22.34	\$20.78	\$19.21	\$17.87	16
	Solder/Solder	PE-SR402AL, PE-SR402FL, RG402, Precision, B06 Mounting Hole, .141" Semi-Rigid	PE4148	\$50.01	\$46.51	\$43.01	\$40.01	17
		PE-SR405AL, PE-SR405FL, RG405, Precision, B06 Mounting Hole, .085" Semi-Rigid	PE4147	\$53.60	\$49.85	\$46.10	\$42.88	18
<b>Female Straight, Panel Mount, Cable Connectors</b>								
	Clamp/Solder	4 Hole Flange, RG58, RG55, RG141, RG142, RG223, RG400, A03 Mounting Hole	PE4066	\$12.21	\$11.36	\$10.50	\$9.77	19
<b>Reverse Polarity Male Straight, Cable Connectors</b>								
	Crimp/Solder	RG8X, PE-C240	PE44670	\$13.93	\$12.95	\$11.98	\$11.14	20
		PE-C400	PE44672	\$17.12	\$15.92	\$14.72	\$13.70	21
		RG174, RG316, RG188	PE4668	\$17.18	\$15.98	\$14.77	\$13.74	22
		RG213, RG8	PE4660	\$17.95	\$16.69	\$15.44	\$14.36	23
		RG214, RG9	PE4661	\$19.40	\$18.04	\$16.68	\$15.52	24
		RG58	PE4664	\$9.60	\$8.93	\$8.26	\$7.68	25
		RG59, RG62	PE4666	\$10.34	\$9.62	\$8.89	\$8.27	26
	Clamp/Solder	RG55, RG141, RG142, RG223, RG400	PE4663	\$10.28	\$9.56	\$8.84	\$8.22	27
		PE-B400, PE-B405	PE4674	\$18.39	\$17.10	\$15.82	\$14.71	28
		PE-SR402AL, PE-SR402FL, RG402, .141" Semi-Rigid	PE4670	\$18.80	\$17.48	\$16.17	\$15.04	29
		PE-SR405AL, PE-SR405FL, RG405, .085" Semi-Rigid	PE4672	\$18.80	\$17.48	\$16.17	\$15.04	30
		RG174, RG316, RG188	PE4667	\$17.85	\$16.60	\$15.35	\$14.28	31
		RG178, RG196	PE4669	\$16.75	\$15.58	\$14.41	\$13.40	32
		RG213, RG214, RG8, RG9, RG225, RG393,	PE4659	\$18.24	\$16.96	\$15.69	\$14.59	33
		RG58, RG55, RG141, RG142, RG400, RG223	PE4662	\$9.73	\$9.05	\$8.37	\$7.78	34
		RG59, RG62	PE4665	\$10.99	\$10.22	\$9.45	\$8.79	35
		PE-SR402AL, PE-SR402FL, RG402, .141" Semi-Rigid	PE4671	\$24.72	\$22.99	\$21.26	\$19.78	36
	Solder/Solder	PE-SR405AL, PE-SR405FL, RG405, .085" Semi-Rigid	PE4673	\$24.72	\$22.99	\$21.26	\$19.78	37
<b>Reverse Polarity Male Right Angle, Cable Connectors</b>								
	Crimp/Solder	RG316, RG174, RG188	PE4681	\$22.09	\$20.54	\$19.00	\$17.67	38
		RG58	PE4678	\$19.66	\$18.28	\$16.91	\$15.73	39
		RG55, RG141, RG142, RG223, RG400	PE4677	\$19.10	\$17.76	\$16.43	\$15.28	40
	Clamp/Solder	RG178, RG196	PE4682	\$22.30	\$20.74	\$19.18	\$17.84	41
		RG213, RG214, RG8, RG9, RG225, RG393,	PE4675	\$33.64	\$31.29	\$28.93	\$26.91	42
		RG316, RG174, RG188	PE4680	\$18.80	\$17.48	\$16.17	\$15.04	43
		RG58, RG55, RG141, RG142, RG400, RG223	PE4676	\$23.41	\$21.77	\$20.13	\$18.73	44
		RG59, RG62	PE4679	\$24.72	\$22.99	\$21.26	\$19.78	45
<b>Reverse Polarity Female Straight, Cable Connectors</b>								
	Crimp/Solder	RG8X, PE-C240	PE44671	\$15.05	\$14.00	\$12.94	\$12.04	46
		PE-C400	PE44673	\$19.25	\$17.90	\$16.56	\$15.40	47
		RG316, RG174, RG188	PE4690	\$15.60	\$14.51	\$13.42	\$12.48	48
		RG58	PE4686	\$12.21	\$11.36	\$10.50	\$9.77	49

Connectors







See Our Website For Real-Time Stock Availability!

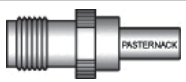
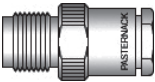

# TNC Connectors

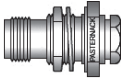
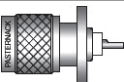
Connectors

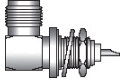
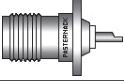
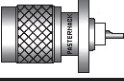

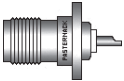
See Our Website For Real-Time Stock Availability!

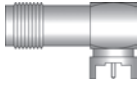

Product Image	Attachment Cable/Contact	Coax Type / Termination Type	Model No.	Price				Row
				1-24	25-49	50-99	100 +	
	Crimp/Solder	RG59, RG62	PE4687	\$14.24	\$13.24	\$12.25	\$11.39	1
		RG55, RG141, RG142, RG223, RG400	PE4685	\$11.90	\$11.07	\$10.23	\$9.52	2
	Clamp/Solder	PE-SR402AL, PE-SR402FL, RG402, .141" Semi-Rigid	PE4692	\$19.10	\$17.76	\$16.43	\$15.28	3
		PE-SR405AL, PE-SR405FL, RG405, .085" Semi-Rigid	PE4693	\$18.80	\$17.48	\$16.17	\$15.04	4
		RG178, RG196	PE4691	\$15.35	\$14.28	\$13.20	\$12.28	5
		RG213, RG214, RG8, RG9, RG225, RG393,	PE4683	\$29.94	\$27.84	\$25.75	\$23.95	6
		RG316, RG174, RG188	PE4689	\$14.10	\$13.11	\$12.13	\$11.28	7
		RG58, RG55, RG141, RG142, RG400, RG223	PE4684	\$12.97	\$12.06	\$11.15	\$10.38	8
		RG59, RG62	PE4688	\$18.64	\$17.34	\$16.03	\$14.91	9
		<b>Reverse Polarity Female Straight, Bulkhead Mount, Cable Connectors</b>						
	Crimp/Solder	RG316, RG174, RG188, B06 Mounting Hole	PE4700	\$19.66	\$18.28	\$16.91	\$15.73	10
		RG58, B06 Mounting Hole	PE4696	\$20.57	\$19.13	\$17.69	\$16.46	11
		RG59, RG62, B06 Mounting Hole	PE4698	\$20.77	\$19.32	\$17.86	\$16.62	12
		RG55, RG141, RG142, RG223, RG400, B06 Mounting Hole	PE4695	\$15.60	\$14.51	\$13.42	\$12.48	13
	Clamp/Solder	PE-SR402AL, PE-SR402FL, RG402, B06 Mounting Hole, .141" Semi-Rigid	PE4702	\$22.30	\$20.74	\$19.18	\$17.84	14
		PE-SR405AL, PE-SR405FL, RG405, B06 Mounting Hole, .085" Semi-Rigid	PE4703	\$22.30	\$20.74	\$19.18	\$17.84	15
		RG178, RG196, B06 Mounting Hole	PE4701	\$19.10	\$17.76	\$16.43	\$15.28	16
		RG316, RG174, RG188, B06 Mounting Hole	PE4699	\$18.80	\$17.48	\$16.17	\$15.04	17
		RG58, RG55, RG141, RG142, RG400, RG223, B06 Mounting Hole	PE4694	\$17.18	\$15.98	\$14.77	\$13.74	18
		RG59, RG62, B06 Mounting Hole	PE4697	\$20.77	\$19.32	\$17.86	\$16.62	19
<b>Male Straight, Panel Mount, Terminal</b>								
	Solder	4 Hole Flange, .050" Dia. Stub Contact, .590" Extended Dielectric, A07 Mounting Hole	PE44654	\$51.83	\$48.20	\$44.57	\$41.46	20
		4 Hole Flange, Solder Cup Contact, A07 Mounting Hole	PE4470	\$14.69	\$13.66	\$12.63	\$11.75	21
<b>Female Straight, Bulkhead Mount, Terminal</b>								
	Solder	Solder Cup Contact, .200 Max Panel, B04 Mounting Hole	PE4065	\$9.73	\$9.05	\$8.37	\$7.78	22
		Solder Cup Contact, .125" Max Panel, B05 Mounting Hole	PE4063	\$16.42	\$15.27	\$14.12	\$13.14	23
		Wire Terminal, Front Mount, Hermetically Sealed, .300" Max Panel, B04 Mounting Hole	PE4305	\$23.96	\$22.28	\$20.61	\$19.17	24
		Wire Terminal, Rear Mount, Hermetically Sealed, .250" Max Panel, B06 Mounting Hole	PE4469	\$30.96	\$28.79	\$26.63	\$24.77	25
		Solder Cup Contact, Isolated Ground, .125" Max Panel, B04 Mounting Hole	PE4306	\$11.60	\$10.79	\$9.98	\$9.28	26
		Solder Cup Contact, Isolated Ground, .180" Max Panel, B06 Mounting Hole	PE4468	\$12.21	\$11.36	\$10.50	\$9.77	27
<b>Female Right Angle, Bulkhead Mount, Terminal</b>								
	Solder	Solder Cup Contact, .275" Max Panel, B13 Mounting Hole	PE4471	\$22.09	\$20.54	\$19.00	\$17.67	28
<b>Female Straight, Panel Mount, Terminal</b>								
	Solder	4 Hole Flange, Solder Cup Contact, A03 Mounting Hole	PE4064	\$9.93	\$9.23	\$8.54	\$7.94	29
<b>Reverse Polarity Male Straight, Panel Mount, Terminal</b>								
	Solder	4 Hole Flange, Solder Cup Contact, A07 Mounting Hole	PE4708	\$17.18	\$15.98	\$14.77	\$13.74	30
<b>Reverse Polarity Female Straight, Bulkhead Mount, Terminal</b>								
	Solder	Solder Cup Contact, .125" Max Panel, B05 Mounting Hole	PE4704	\$12.97	\$12.06	\$11.15	\$10.38	31
		Solder Cup Contact, .150" Max Panel, B04 Mounting Hole	PE4706	\$12.97	\$12.06	\$11.15	\$10.38	32
		Solder Cup Contact, Isolated Ground, .180" Max Panel, B06 Mounting Hole	PE4707	\$17.48	\$16.26	\$15.03	\$13.98	33
<b>Reverse Polarity Female Straight, Panel Mount, Terminal</b>								
	Solder	4 Hole Flange, Solder Cup Contact, A03 Mounting Hole	PE4705	\$17.48	\$16.26	\$15.03	\$13.98	34

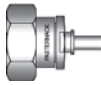

# TNC Connectors

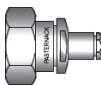
Product Image	Attachment Cable/Contact	Coax Type / Termination Type	Model No.	Price				Row
				1-24	25-49	50-99	100 +	
<b>Female Right Angle, PCB Mount</b>								
	Solder	.035" Dia. Contact, .118" Leg Length, Thru Hole, D17 Mounting Hole	PE44659	\$11.75	\$10.93	\$10.11	\$9.40	1

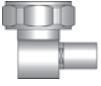
# 7/16 DIN Connectors

Product Image	Attachment Cable/Contact	Coax Type / Termination Type	Model No.	Price				Row
				1-24	25-49	50-99	100 +	
<b>Male Straight, Cable Connectors</b>								
	Crimp/Solder	PE-C195	PE44536	\$35.77	\$33.27	\$30.76	\$28.62	2
		PE-C240	PE44537	\$35.77	\$33.27	\$30.76	\$28.62	3
		PE-C400	PE44538	\$42.66	\$39.67	\$36.69	\$34.13	4
		PE-C600	PE44539	\$47.73	\$44.39	\$41.05	\$38.18	5
		RG213, RG8	PE4570	\$88.80	\$82.58	\$76.37	\$71.04	6
		RG214, RG9, RG225, RG393	PE4571	\$86.33	\$80.29	\$74.24	\$69.06	7
		RG58	PE4569	\$81.75	\$76.03	\$70.31	\$65.40	8
	Clamp	RG55, RG142, RG223, RG400	PE4568	\$84.56	\$78.64	\$72.72	\$67.65	9
		1/4 inch Super Flexible, Precision, Low PIM	PE44728	\$54.31	\$50.51	\$46.71	\$43.45	10
		1/2 inch Flexible, Precision, Low PIM	PE44738	\$27.83	\$25.88	\$23.93	\$22.26	11
	Clamp/Solder	1/2 inch Super Flexible, Precision, Low PIM	PE44732	\$27.83	\$25.88	\$23.93	\$22.26	12
		PE-SR401AL, PE-SR401FL, RG401, .250" Semi-Rigid	PE44278	\$102.50	\$95.33	\$88.15	\$82.00	13
		PE-SR402AL, PE-SR402FL, RG402, .141" Semi-Rigid	PE44279	\$102.50	\$95.33	\$88.15	\$82.00	14
		1/2" Helical, Low PIM	PE44557	\$48.84	\$45.42	\$42.00	\$39.07	15
		1/2" Annular, Low PIM	PE44567	\$47.73	\$44.39	\$41.05	\$38.18	16
		7/8" Annular, Low PIM	PE44568	\$65.66	\$61.06	\$56.47	\$52.53	17
		7/8" Helical, Low PIM	PE44558	\$65.66	\$61.06	\$56.47	\$52.53	18
		RG14, RG217	PE44276	\$105.99	\$98.57	\$91.15	\$84.79	19
		RG213, RG214, RG8, RG9, RG225, RG393, RG218	PE4567	\$71.34	\$66.35	\$61.35	\$57.07	20
		RG58, RG55, RG141, RG142, RG400, RG223	PE44277	\$114.10	\$106.11	\$98.13	\$91.28	21
			PE4566	\$99.76	\$92.78	\$85.79	\$79.81	22

<b>Male Right Angle, Cable Connectors</b>								
	Crimp/Solder	PE-C195	PE44540	\$47.73	\$44.39	\$41.05	\$38.18	23
		PE-C240	PE44541	\$52.49	\$48.82	\$45.14	\$41.99	24
		PE-C400	PE44542	\$50.72	\$47.17	\$43.62	\$40.58	25
		PE-C600	PE44543	\$59.63	\$55.46	\$51.28	\$47.70	26
	Clamp/Solder	1/2" Helical, Low PIM	PE44559	\$59.63	\$55.46	\$51.28	\$47.70	27
		1/2" Annular, Low PIM	PE44569	\$59.63	\$55.46	\$51.28	\$47.70	28
		RG14, RG217	PE44282	\$149.66	\$139.18	\$128.71	\$119.73	29
		RG213, RG214, RG8, RG9, RG225, RG393, RG58, RG55, RG141, RG142, RG400, RG223	PE44280	\$114.81	\$106.77	\$98.74	\$91.85	30
			PE44281	\$149.66	\$139.18	\$128.71	\$119.73	31

<b>Female Straight, Cable Connectors</b>								
	Clamp	1/2 inch Flexible, Precision, Low PIM	PE44740	\$27.83	\$25.88	\$23.93	\$22.26	32
		1/2 inch Super Flexible, Precision, Low PIM	PE44734	\$27.83	\$25.88	\$23.93	\$22.26	33
	Crimp/Solder	PE-C195	PE44544	\$47.73	\$44.39	\$41.05	\$38.18	34
		PE-C240	PE44545	\$47.73	\$44.39	\$41.05	\$38.18	35
		PE-C400	PE44546	\$53.65	\$49.89	\$46.14	\$42.92	36
		PE-C600	PE44547	\$59.63	\$55.46	\$51.28	\$47.70	37
		RG213, RG8	PE44284	\$96.80	\$90.02	\$83.25	\$77.44	38
		RG214, RG9, RG225, RG393	PE4575	\$105.94	\$98.52	\$91.11	\$84.75	39
		RG58	PE44287	\$84.10	\$78.21	\$72.33	\$67.28	40
		RG55, RG142, RG223, RG400	PE44286	\$112.22	\$104.36	\$96.51	\$89.78	41

Connectors

See Our Website For Real-Time Stock Availability!

# 7/16 DIN Connectors

Connectors

Product Image	Attachment Cable/Contact	Coax Type / Termination Type	Model No.	Price				Row
				1-24	25-49	50-99	100 +	
	Clamp/Solder	PE-SR401AL, PE-SR401FL, RG401, .250" Semi-Rigid	PE44289	\$95.05	\$88.40	\$81.74	\$76.04	1
		PE-SR402AL, PE-SR402FL, RG402, .141" Semi-Rigid	PE44290	\$95.05	\$88.40	\$81.74	\$76.04	2
		1/2" Helical, Low PIM	PE44560	\$53.65	\$49.89	\$46.14	\$42.92	3
		1/2" Annular, Low PIM	PE44570	\$47.73	\$44.39	\$41.05	\$38.18	4
		7/8" Annular, Low PIM	PE44571	\$59.63	\$55.46	\$51.28	\$47.70	5
		7/8" Helical, Low PIM	PE44561	\$65.66	\$61.06	\$56.47	\$52.53	6
		RG14, RG217	PE44288	\$104.78	\$97.45	\$90.11	\$83.82	7
		RG213, RG214, RG8, RG9, RG225, RG393	PE44283	\$112.22	\$104.36	\$96.51	\$89.78	8
		RG58, RG55, RG141, RG142, RG400, RG223	PE44285	\$112.22	\$104.36	\$96.51	\$89.78	9

## Female Straight, Bulkhead Mount, Cable Connectors

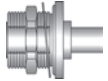
	Crimp/Solder	PE-C195, G08 Mounting Hole	PE44548	\$53.65	\$49.89	\$46.14	\$42.92	10
		PE-C240, G08 Mounting Hole	PE44549	\$53.65	\$49.89	\$46.14	\$42.92	11
		PE-C400, G08 Mounting Hole	PE44550	\$59.63	\$55.46	\$51.28	\$47.70	12
		PE-C600, G08 Mounting Hole	PE44551	\$65.66	\$61.06	\$56.47	\$52.53	13
		RG55, RG142, RG223, RG400, G08 Mounting Hole	PE44656	\$53.45	\$49.71	\$45.97	\$42.76	14

## Female Straight, Panel Mount, Cable Connectors

	Clamp/Solder	4 Hole Flange, RG14, RG217, A21 Mounting Hole	PE44292	\$124.69	\$115.96	\$107.23	\$99.75	15
		4 Hole Flange, RG213, RG214, RG8, RG9, RG225, RG393, A21 Mounting Hole	PE44291	\$124.69	\$115.96	\$107.23	\$99.75	16



## Female Straight, Bulkhead Mount, Terminal

	Solder	Solder Cup Contact, Rear Mount, .197" Max Panel	PE4572	\$124.69	\$115.96	\$107.23	\$99.75	17
---	--------	---	--------	----------	----------	----------	---------	----

## Female Straight, Panel Mount, Terminal

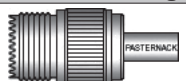
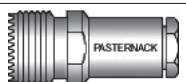

	Solder	4 Hole Flange, Pin, A21 Mounting Hole	PE4574	\$70.68	\$65.73	\$60.78	\$56.54	18
		4 Hole Flange, Solder Cup Contact, A21 Mounting Hole	PE4573	\$70.68	\$65.73	\$60.78	\$56.54	19

# UHF Connectors





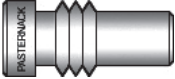

Product Image	Attachment Cable/Contact	Coax Type / Termination Type	Model No.	Price				Row
				1-24	25-49	50-99	100 +	
<b>Male Straight, Cable Connectors</b>								
	Crimp/Solder	PE-B400, PE-B405, PE-C400	PE44054	\$9.07	\$8.44	\$7.80	\$7.26	20
		RG213, RG8	PE4295	\$11.22	\$10.43	\$9.65	\$8.98	21
		RG214, RG9, RG225, RG393	PE44051	\$9.60	\$8.93	\$8.26	\$7.68	22
		RG58	PE4069	\$5.82	\$5.41	\$5.01	\$4.66	23
		RG59, RG62	PE4073	\$6.03	\$5.61	\$5.19	\$4.82	24
	Clamp/Solder	RG55, RG141, RG142, RG223, RG400	PE44053	\$6.80	\$6.32	\$5.85	\$5.44	25
		RG213, RG214, RG8, RG9, RG11, RG225, RG393	PE44050	\$8.77	\$8.16	\$7.54	\$7.02	26
	Solder/Solder	RG213, RG214, RG8, RG9, RG225, RG393,	PE4020	\$10.75	\$10.00	\$9.25	\$8.60	28
<b>Female Straight, Cable Connectors</b>								
	Crimp/Solder	RG58	PE44058	\$11.60	\$10.79	\$9.98	\$9.28	29
		RG55, RG141, RG142, RG223, RG400	PE44057	\$10.80	\$10.04	\$9.29	\$8.64	30
	Clamp/Solder	RG213, RG214, RG8, RG9, RG11, RG225, RG393	PE44055	\$10.99	\$10.22	\$9.45	\$8.79	31
		RG58, RG55, RG141, RG142, RG400, RG223	PE44056	\$11.60	\$10.79	\$9.98	\$9.28	32

See Our Website For Real-Time Stock Availability!

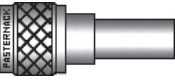
# UHF Connectors

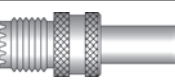
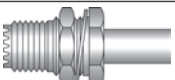
Product Image	Attachment Cable/Contact	Coax Type / Termination Type	Model No.	Price				Row
				1-24	25-49	50-99	100 +	
<b>Sexless Straight, Accessories, Cable Connectors</b>								
	Accessories	RG58, Use with PE4020	PE4022	\$1.21	\$1.13	\$1.04	\$0.97	1
		RG59, Use with PE4020	PE4021	\$1.26	\$1.17	\$1.08	\$1.01	2
<b>Female Straight, Bulkhead Mount, Terminal</b>								
	Solder	Solder Cup Contact, Rear Mount, .090" Max Panel, B12 Mounting Hole	PE44060	\$7.75	\$7.21	\$6.67	\$6.20	3
		Solder Cup Contact, Front Mount, .080" Max Panel, B12 Mounting Hole	PE44059	\$8.02	\$7.46	\$6.90	\$6.42	4
<b>Female Straight, Panel Mount, Terminal</b>								
	Solder	4 Hole Flange, Solder Cup Contact, A05 Mounting Hole	PE4012	\$6.66	\$6.19	\$5.73	\$5.33	5

# MINI UHF Connectors

Product Image	Attachment Cable/Contact	Coax Type / Termination Type	Model No.	Price				Row
				1-24	25-49	50-99	100 +	
<b>Male Straight, Cable Connectors</b>								
	Crimp/Solder	RG174, RG316, RG188	PE44090	\$9.07	\$8.44	\$7.80	\$7.26	6
		RG58	PE4342	\$4.97	\$4.62	\$4.27	\$3.98	7
		RG55, RG141, RG142, RG223, RG400	PE4521	\$4.80	\$4.46	\$4.13	\$3.84	8
		RG55, RG141, RG142, RG223, RG400, Push-On	PE44088	\$7.75	\$7.21	\$6.67	\$6.20	9
<b>Male Right Angle, Cable Connectors</b>								
	Crimp/Solder	RG58	PE44082	\$11.60	\$10.79	\$9.98	\$9.28	10
		RG55, RG141, RG142, RG223, RG400	PE44081	\$9.45	\$8.79	\$8.13	\$7.56	11
<b>Female Straight, Cable Connectors</b>								
	Crimp/Solder	RG174, RG316, RG188	PE44085	\$10.34	\$9.62	\$8.89	\$8.27	12
		RG58	PE44084	\$9.39	\$8.73	\$8.08	\$7.51	13
		RG55, RG141, RG142, RG223, RG400	PE44083	\$8.35	\$7.77	\$7.18	\$6.68	14
<b>Female Straight, Bulkhead Mount, Cable Connectors</b>								
	Crimp/Solder	RG58, B05 Mounting Hole	PE44087	\$10.70	\$9.95	\$9.20	\$8.56	15
		RG55, RG141, RG142, RG223, RG400, B05 Mounting Hole	PE44086	\$9.45	\$8.79	\$8.13	\$7.56	16
<b>Female Straight, Bulkhead Mount, Terminal</b>								
	Solder	Solder Cup Contact, Front Mount, .125" Max Panel, B04 Mounting Hole	PE44089	\$5.22	\$4.85	\$4.49	\$4.18	17
		Solder Cup Contact, Rear Mount, .125" Max Panel, B04 Mounting Hole	PE4644	\$5.22	\$4.85	\$4.49	\$4.18	18
<b>Female Straight, Panel Mount, Terminal</b>								
	Solder	4 Hole Flange, Solder Cup Contact, A18 Mounting Hole	PE44091	\$8.02	\$7.46	\$6.90	\$6.42	19
<b>Female Straight, Bulkhead Mount, PCB Mount</b>								
	Solder	.040" Dia Contact, .157" Leg Length, D05 & F05 Mounting Hole	PE44092	\$7.75	\$7.21	\$6.67	\$6.20	20



Connectors

See Our Website For Real-Time Stock Availability!





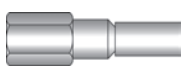
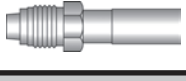





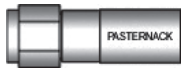

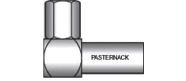
# FME Connectors

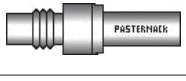
Product Image	Attachment Cable/Contact	Coax Type / Termination Type	Model No.	Price				Row
				1-24	25-49	50-99	100 +	
<b>Plug Straight, Cable Connectors</b>								
	Crimp/Solder	RG174, RG316, RG188	PE44297	\$8.56	\$7.96	\$7.36	\$6.85	1
		RG58	PE44295	\$9.07	\$8.44	\$7.80	\$7.26	2
		RG55, RG142, RG223, RG400	PE44296	\$8.35	\$7.77	\$7.18	\$6.68	3
<b>Jack Straight, Cable Connectors</b>								
	Crimp/Solder	RG174, RG316, RG188	PE44148	\$8.66	\$8.05	\$7.45	\$6.93	4
		RG58	PE44146	\$6.18	\$5.75	\$5.31	\$4.94	5
		RG55, RG142, RG223, RG400	PE44147	\$5.95	\$5.53	\$5.12	\$4.76	6
<b>Plug Straight, Bulkhead Mount, Terminal</b>								
	Solder	Solder Cup Contact, Front Mount, .175" Max Panel, B04 Mounting Hole	PE44149	\$6.43	\$5.98	\$5.53	\$5.14	7

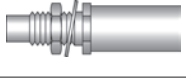





# SMC Connectors

Product Image	Attachment Cable/Contact	Coax Type / Termination Type	Model No.	Price				Row
				1-24	25-49	50-99	100 +	
<b>Plug Straight, Cable Connectors</b>								
	Crimp/Solder	RG174, RG316, RG188	PE4045	\$9.28	\$8.63	\$7.98	\$7.42	8
		RG178, RG196	PE4074	\$12.90	\$12.00	\$11.09	\$10.32	9
		RG58	PE4558	\$17.63	\$16.40	\$15.16	\$14.10	10
		RG55, RG142, RG223, RG400	PE4594	\$17.00	\$15.81	\$14.62	\$13.60	11
	Clamp/Solder	PE-SR405AL, PE-SR405FL, RG405, .085" Semi-Rigid	PE4357	\$16.16	\$15.03	\$13.90	\$12.93	12
		RG174, RG316, RG188	PE4201	\$9.73	\$9.05	\$8.37	\$7.78	13
		RG178, RG196	PE4202	\$13.68	\$12.72	\$11.76	\$10.94	14
<b>Plug Right Angle, Cable Connectors</b>								
	Crimp/Solder	RG174, RG316, RG188	PE4051	\$12.90	\$12.00	\$11.09	\$10.32	15
		RG178, RG196	PE4160	\$12.21	\$11.36	\$10.50	\$9.77	16
		RG58	PE4557	\$15.96	\$14.84	\$13.73	\$12.77	17
		RG55, RG142, RG223, RG400	PE4596	\$15.60	\$14.51	\$13.42	\$12.48	18
	Clamp/Solder	PE-SR405AL, PE-SR405FL, RG405, .085" Semi-Rigid	PE4359	\$18.59	\$17.29	\$15.99	\$14.87	19
		RG174, RG316, RG188	PE4262	\$11.70	\$10.88	\$10.06	\$9.36	20
		RG178, RG196	PE4263	\$12.41	\$11.54	\$10.67	\$9.93	21
<b>Jack Straight, Cable Connectors</b>								
	Crimp/Solder	RG174, RG316, RG188	PE4094	\$12.41	\$11.54	\$10.67	\$9.93	22
		RG178, RG196	PE4927	\$13.68	\$12.72	\$11.76	\$10.94	23
	Clamp/Solder	PE-SR405AL, PE-SR405FL, RG405, .085" Semi-Rigid	PE4361	\$22.34	\$20.78	\$19.21	\$17.87	24
		RG174, RG316, RG188	PE4270	\$22.34	\$20.78	\$19.21	\$17.87	25
		RG178, RG196	PE4271	\$22.34	\$20.78	\$19.21	\$17.87	26
<b>Jack Straight, Bulkhead Mount, Cable Connectors</b>								
	Crimp/Solder	RG174, RG316, RG188, B01 Mounting Hole	PE4095	\$11.70	\$10.88	\$10.06	\$9.36	27
		RG178, RG196, B01 Mounting Hole	PE4365	\$23.66	\$22.00	\$20.35	\$18.93	28
		RG58, B01 Mounting Hole	PE44095	\$20.50	\$19.07	\$17.63	\$16.40	29
	Clamp/Solder	RG55, RG142, RG223, RG400, B01 Mounting Hole	PE44047	\$21.13	\$19.65	\$18.17	\$16.90	30
		PE-SR405AL, PE-SR405FL, RG405, B01 Mounting Hole, .085" Semi-Rigid	PE4363	\$24.88	\$23.14	\$21.40	\$19.90	31
		RG174, RG316, RG188, B01 Mounting Hole	PE4278	\$24.88	\$23.14	\$21.40	\$19.90	32
		RG178, RG196, B01 Mounting Hole	PE4279	\$24.88	\$23.14	\$21.40	\$19.90	33

Connectors

See Our Website For Real-Time Stock Availability!

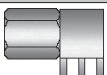
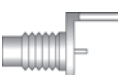
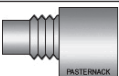
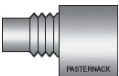
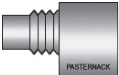
# SMC Connectors

Product Image	Attachment Cable/Contact	Coax Type / Termination Type	Model No.	Price				Row
				1-24	25-49	50-99	100 +	
<b>Plug Straight, Bulkhead Mount, Terminal</b>								
	Solder	Solder Cup Contact, Front Mount, .093" Max Panel, B01 Mounting Hole	PE4289	\$16.16	\$15.03	\$13.90	\$12.93	1
<b>Jack Straight, Bulkhead Mount, Terminal</b>								
	Solder	Solder Cup Contact, Front Mount, .093" Max Panel, B01 Mounting Hole	PE4171	\$9.70	\$9.02	\$8.34	\$7.76	2
		Solder Cup Contact, Rear Mount, .093" Max Panel, B01 Mounting Hole	PE4107	\$9.70	\$9.02	\$8.34	\$7.76	3
<b>Jack Right Angle, Bulkhead Mount, Terminal</b>								
	Solder	Solder Cup Contact, .100" Max Panel, B01 Mounting Hole	PE4285	\$22.44	\$20.87	\$19.30	\$17.95	4
<b>Jack Straight, Panel Mount, Terminal</b>								
	Solder	2 Hole Flange, Solder Cup Contact, C07 Mounting Hole	PE44140	\$15.35	\$14.28	\$13.20	\$12.28	5
		4 Hole Flange, Solder Cup Contact, A22 Mounting Hole	PE44143	\$15.30	\$14.23	\$13.16	\$12.24	6
<b>Plug Straight, PCB Mount</b>								
	Solder	.036" Dia. Contact, .142" Leg Length, Thru Hole, D02 Mounting Hole	PE4367	\$11.20	\$10.42	\$9.63	\$8.96	7
<b>Plug Right Angle, PCB Mount</b>								
	Solder	.040" Dia. Contact, .166" Leg Length, Thru Hole, D02 Mounting Hole	PE4246	\$21.13	\$19.65	\$18.17	\$16.90	8
<b>Jack Straight, PCB Mount</b>								
	Solder	.042" End Launch, .030" Round Contact	PE44133	\$19.91	\$18.52	\$17.12	\$15.93	9
		.042" End Launch, .020" x .010" Tab Contact	PE44138	\$19.91	\$18.52	\$17.12	\$15.93	10
		.062" End Launch, .020" x .010" Tab Contact	PE44136	\$19.00	\$17.67	\$16.34	\$15.20	11
		.062" End Launch, .030" Round Contact	PE44130	\$37.34	\$34.73	\$32.11	\$29.87	12
		Surface Mount	PE44120	\$12.36	\$11.49	\$10.63	\$9.89	13
		.037" Dia. Contact, .155" Leg Length, Thru Hole, D02 Mounting Hole	PE4175	\$6.64	\$6.18	\$5.71	\$5.31	14
<b>Jack Right Angle, PCB Mount</b>								
	Solder	Surface Mount	PE44122	\$10.34	\$9.62	\$8.89	\$8.27	15
<b>Jack Right Angle, Bulkhead Mount, PCB Mount</b>								
	Solder	.038" Dia. Contact, .155" Leg Length, .093" Max Panel, Thru Hole, B01 & D01 Mounting Hole	PE44127	\$15.96	\$14.84	\$13.73	\$12.77	16
<b>Jack Right Angle, PCB Mount</b>								
	Solder	.038" Dia. Contact, .155" Leg Length, Thru Hole, D02 Mounting Hole	PE4178	\$11.22	\$10.43	\$9.65	\$8.98	17
<b>Jack Straight, Bulkhead Mount, PCB Mount</b>								
	Solder	.038" Dia. Contact, .155" Leg Length, .093" Max Panel, Thru Hole, B01 Mounting Hole	PE44124	\$20.06	\$18.66	\$17.25	\$16.05	18

Connectors

See Our Website For Real-Time Stock Availability!

# 10-32 Connectors

Connectors



See Our Website For Real-Time Stock Availability!

Product Image	Attachment Cable/Contact	Coax Type / Termination Type	Model No.	Price				Row
				1-24	25-49	50-99	100 +	
<b>Male Straight, Cable Connectors</b>								
	Crimp/Solder	RG174, RG316, RG188	PE44351	\$16.57	\$15.41	\$14.25	\$13.26	1
		RG178, RG196	PE44352	\$25.89	\$24.08	\$22.27	\$20.71	2
	Clamp/Solder	RG174, RG316, RG188	PE44353	\$24.42	\$22.71	\$21.00	\$19.54	3
		RG178, RG196	PE44354	\$24.88	\$23.14	\$21.40	\$19.90	4
<b>Male Right Angle, Cable Connectors</b>								
	Crimp/Solder	RG174, RG316, RG188	PE44355	\$18.75	\$17.44	\$16.13	\$15.00	5
		RG178, RG196	PE44356	\$23.66	\$22.00	\$20.35	\$18.93	6
<b>Female Straight, Cable Connectors</b>								
	Crimp/Solder	RG174, RG316, RG188	PE44361	\$21.13	\$19.65	\$18.17	\$16.90	7
		RG178, RG196	PE44362	\$21.13	\$19.65	\$18.17	\$16.90	8
	Clamp/Solder	RG174, RG316, RG188	PE44363	\$23.66	\$22.00	\$20.35	\$18.93	9
		RG178, RG196	PE44364	\$23.66	\$22.00	\$20.35	\$18.93	10
<b>Female Straight, Bulkhead Mount, Cable Connectors</b>								
	Crimp/Solder	RG174, RG316, RG188, B03 Mounting Hole	PE44365	\$24.88	\$23.14	\$21.40	\$19.90	11
		RG178, RG196, B03 Mounting Hole	PE44366	\$24.88	\$23.14	\$21.40	\$19.90	12
	Clamp/Solder	RG174, RG316, RG188, B03 Mounting Hole	PE44367	\$24.88	\$23.14	\$21.40	\$19.90	13
		RG178, RG196, B03 Mounting Hole	PE44368	\$24.88	\$23.14	\$21.40	\$19.90	14
<b>Female Straight, Bulkhead Mount, Terminal</b>								
	Solder	Solder Cup Contact, Front Mount, .150" Max Panel, B01 Mounting Hole	PE44357	\$18.75	\$17.44	\$16.13	\$15.00	15
		Solder Cup Contact, Rear Mount, .141" Max Panel, B03 Mounting Hole	PE44358	\$23.66	\$22.00	\$20.35	\$18.93	16
<b>Female Straight, PCB Mount</b>								
	Solder	.052" Dia. Contact, .155" Leg Length, Thru Hole, D01 Mounting Hole	PE44359	\$17.63	\$16.40	\$15.16	\$14.10	17
<b>Female Right Angle, PCB Mount</b>								
	Solder	.050" Dia. Contact, .155" Leg Length, Thru Hole, D01 Mounting Hole	PE44360	\$21.58	\$20.07	\$18.56	\$17.26	18



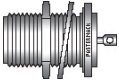

# SC Connectors

Product Image	Attachment Cable/Contact	Coax Type / Termination Type	Model No.	Price				Row
				1-24	25-49	50-99	100 +	
<b>Male Straight, Cable Connectors</b>								
	Crimp/Solder	RG214, RG9, RG225, RG393	PE4232	\$46.81	\$43.53	\$40.26	\$37.45	19
		RG55, RG141, RG142, RG223, RG400	PE4231	\$87.30	\$81.19	\$75.08	\$69.84	20
	Clamp/Solder	RG14, RG217	PE4976	\$105.94	\$98.52	\$91.11	\$84.75	21
		RG213, RG214, RG8, RG9, RG225, RG393	PE4520	\$124.69	\$115.96	\$107.23	\$99.75	22
		RG218	PE4977	\$105.94	\$98.52	\$91.11	\$84.75	23
		RG58, RG55, RG141, RG142, RG400, RG223	PE4519	\$87.30	\$81.19	\$75.08	\$69.84	24

# SC Connectors

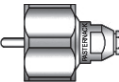
Product Image	Attachment Cable/Contact	Coax Type / Termination Type	Model No.	Price				Row
				1-24	25-49	50-99	100 +	
<b>Male Right Angle, Cable Connectors</b>								
	Clamp/Solder	RG213, RG214, RG8, RG9, RG393,	PE4979	\$116.88	\$108.70	\$100.52	\$93.50	1
		RG58, RG55, RG141, RG142, RG400, RG223	PE4978	\$99.76	\$92.78	\$85.79	\$79.81	2
<b>Female Straight, Bulkhead Mount, Terminal</b>								
	Solder	Wire Terminal, Hermetically Sealed, .250" Max Panel, B11 Mounting Hole	PE4980	\$28.93	\$26.90	\$24.88	\$23.14	3
<b>Female Straight, Panel Mount, Terminal</b>								
	Solder	4 Hole Flange, Solder Cup Contact, A13 Mounting Hole	PE4322	\$87.30	\$81.19	\$75.08	\$69.84	4

# LC Connectors

Product Image	Attachment Cable/Contact	Coax Type / Termination Type	Model No.	Price				Row
				1-24	25-49	50-99	100 +	
<b>Male Straight, Cable Connectors</b>								
	Clamp/Solder	RG14, RG217	PE4563	\$129.60	\$120.53	\$111.46	\$103.68	5
		RG213, RG214, RG8, RG9, RG225, RG393	PE4564	\$114.65	\$106.62	\$98.60	\$91.72	6
		RG218, RG219	PE4323	\$153.01	\$142.30	\$131.59	\$122.41	7
		RG58, RG55, RG142, RG223, RG400	PE4565	\$137.25	\$127.64	\$118.04	\$109.80	8
<b>Male Right Angle, Cable Connectors</b>								
	Clamp/Solder	RG14, RG217	PE44448	\$180.82	\$168.16	\$155.51	\$144.66	9
		RG213, RG214, RG8, RG9, RG225, RG393	PE44447	\$174.64	\$162.42	\$150.19	\$139.71	10
		RG218	PE44449	\$189.18	\$175.94	\$162.69	\$151.34	11
<b>Female Straight, Cable Connectors</b>								
	Clamp/Solder	RG213, RG214, RG8, RG9, RG225, RG393	PE44450	\$156.30	\$145.36	\$134.42	\$125.04	12
		RG218	PE44451	\$178.54	\$166.04	\$153.54	\$142.83	13
<b>Female Straight, Panel Mount, Terminal</b>								
	Solder	4 Hole Flange, Pin, A12 Mounting Hole	PE4192	\$80.96	\$75.29	\$69.63	\$64.77	14

# HN Connectors

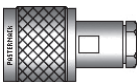
Product Image	Attachment Cable/Contact	Coax Type / Termination Type	Model No.	Price				Row
				1-24	25-49	50-99	100 +	
<b>Male Straight, Cable Connectors</b>								
	Crimp/Solder	RG213, RG8	PE4473	\$31.20	\$29.02	\$26.83	\$24.96	15
		RG214, RG9, RG225, RG393	PE4474	\$32.02	\$29.78	\$27.54	\$25.62	16
		RG58, RG141	PE4478	\$25.20	\$23.44	\$21.67	\$20.16	17
		RG55, RG142, RG223, RG400	PE4477	\$26.95	\$25.06	\$23.18	\$21.56	18
	Clamp/Solder	RG14, RG217	PE4475	\$32.58	\$30.30	\$28.02	\$26.06	19
		RG17, RG218	PE4476	\$94.64	\$88.02	\$81.39	\$75.71	20
		RG213, RG214, RG8, RG9, RG225, RG393	PE4182	\$18.67	\$17.36	\$16.06	\$14.94	21
		RG58, RG55, RG141, RG142, RG400, RG223	PE4198	\$25.84	\$24.03	\$22.22	\$20.67	22
		RG59, RG62	PE4479	\$36.51	\$33.95	\$31.40	\$29.21	23



Connectors

See Our Website For Real-Time Stock Availability!





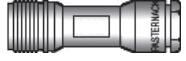
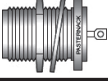

# HN Connectors

Connectors

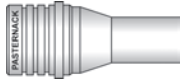
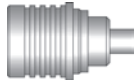

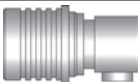
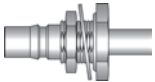
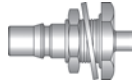

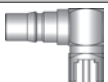

Product Image	Attachment Cable/Contact	Coax Type / Termination Type	Model No.	Price				Row
				1-24	25-49	50-99	100 +	
<b>Male Right Angle, Cable Connectors</b>								
	Clamp/Solder	RG14, RG217	PE44592	\$42.96	\$39.95	\$36.95	\$34.37	1
		RG213, RG214, RG8, RG9, RG225, RG393	PE4230	\$47.52	\$44.19	\$40.87	\$38.02	2
		RG58, RG55, RG141, RG142, RG400, RG223	PE4480	\$50.56	\$47.02	\$43.48	\$40.45	3
<b>Female Straight, Cable Connectors</b>								
	Clamp/Solder	RG213, RG214, RG8, RG9, RG225, RG393	PE4229	\$40.23	\$37.41	\$34.60	\$32.18	4
<b>Female Straight, Bulkhead Mount, Terminal</b>								
	Solder	Wire Terminal, Hermetically Sealed, Rear Mount, .300" Max Panel, G03 Mounting Hole	PE4481	\$44.58	\$41.46	\$38.34	\$35.66	5
<b>Female Straight, Panel Mount, Terminal</b>								
	Solder	4 Hole Flange, Solder Cup Contact, A08 Mounting Hole	PE4183	\$20.98	\$19.51	\$18.04	\$16.78	6

# QMA Connectors

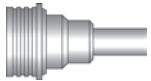

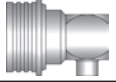
Product Image	Attachment Cable/Contact	Coax Type / Termination Type	Model No.	Price				Row
				1-24	25-49	50-99	100 +	
<b>Male Straight, Cable Connectors</b>								
	Crimp/Solder	RG316-DS, RG188-DS, 18 GHz	PE44502	\$15.00	\$13.95	\$12.90	\$12.00	7
		RG174, RG316, RG188, 18 GHz	PE44501	\$15.00	\$13.95	\$12.90	\$12.00	8
		RG58, RG141, 18 GHz	PE44503	\$14.08	\$13.09	\$12.11	\$11.26	9
	Solder/Solder	PE-SR402AL, PE-SR402FL, RG402, 18 GHz, .141" Semi-Rigid	PE44496	\$15.00	\$13.95	\$12.90	\$12.00	10
		PE-SR405AL, PE-SR405FL, RG405, 18 GHz, .085" Semi-Rigid	PE44495	\$15.00	\$13.95	\$12.90	\$12.00	11
<b>Male Right Angle, Cable Connectors</b>								
	Crimp/Solder	RG316-DS, RG188-DS, 18 GHz	PE44505	\$17.48	\$16.26	\$15.03	\$13.98	12
		RG174, RG316, RG188, 18 GHz	PE44504	\$17.48	\$16.26	\$15.03	\$13.98	13
		RG58, RG141, 18 GHz	PE44506	\$18.59	\$17.29	\$15.99	\$14.87	14
		RG55, RG142, RG223, RG400, 18 GHz	PE44515	\$21.75	\$20.23	\$18.71	\$17.40	15
	Solder/Solder	PE-SR402AL, PE-SR402FL, RG402, 18 GHz, .141" Semi-Rigid	PE44498	\$18.59	\$17.29	\$15.99	\$14.87	16
		PE-SR405AL, PE-SR405FL, RG405, 18 GHz, .085" Semi-Rigid	PE44497	\$18.59	\$17.29	\$15.99	\$14.87	17
<b>Female Straight, Bulkhead Mount, Cable Connectors</b>								
	Crimp/Solder	RG316-DS, RG188-DS, B17 Mounting Hole, 18 GHz	PE44508	\$15.00	\$13.95	\$12.90	\$12.00	18
		RG174, RG316, RG188, B17 Mounting Hole, 18 GHz	PE44507	\$15.00	\$13.95	\$12.90	\$12.00	19
		RG58, RG141, B17 Mounting Hole, 18 GHz	PE44509	\$15.00	\$13.95	\$12.90	\$12.00	20
	Solder/Solder	PE-SR402AL, PE-SR402FL, RG402, B17 Mounting Hole, 18 GHz, .141" Semi-Rigid	PE44500	\$17.48	\$16.26	\$15.03	\$13.98	21
		PE-SR405AL, PE-SR405FL, RG405, B17 Mounting Hole, 18 GHz, .085" Semi-Rigid	PE44499	\$17.48	\$16.26	\$15.03	\$13.98	22
<b>Female Straight, PCB Mount</b>								
	Solder	Surface Mount, 18 GHz	PE44510	\$41.14	\$38.26	\$35.38	\$32.91	23
		Thru Hole, 18 GHz	PE44512	\$9.88	\$9.19	\$8.50	\$7.90	24
<b>Female Right Angle, PCB Mount</b>								
	Solder	Surface Mount, 18 GHz	PE44511	\$24.88	\$23.14	\$21.40	\$19.90	25
		Thru Hole, 18 GHz	PE44513	\$18.59	\$17.29	\$15.99	\$14.87	26

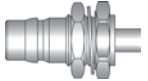
See Our Website For Real-Time Stock Availability!

# QN Connectors

Product Image	Attachment Cable/Contact	Coax Type / Termination Type	Model No.	Price				Row
				1-24	25-49	50-99	100 +	
<b>Male Straight, Cable Connectors</b>								
	Crimp/Solder	RG213, RG215, RG8, 11 GHz	PE44597	\$34.05	\$31.67	\$29.28	\$27.24	1
		RG214, RG225, RG9, RG393, 11 GHz	PE44598	\$33.39	\$31.05	\$28.72	\$26.71	2
		RG58, RG141, RG303, 11 GHz	PE44596	\$23.81	\$22.14	\$20.48	\$19.05	3
		RG55, RG142, RG223, RG400, 11 GHz	PE44595	\$26.19	\$24.36	\$22.52	\$20.95	4
	Solder/Solder	PE-SR402AL, PE-SR402FL, RG402, 11 GHz, .141" Semi-Rigid	PE44599	\$29.79	\$27.70	\$25.62	\$23.83	5
<b>Male Right Angle, Cable Connectors</b>								
	Crimp/Solder	RG213, RG215, RG8, 11 GHz	PE44602	\$39.32	\$36.57	\$33.82	\$31.46	6
		RG214, RG225, RG9, RG393, 11 GHz	PE44603	\$39.32	\$36.57	\$33.82	\$31.46	7
		RG58, RG141, RG303, 11 GHz	PE44601	\$29.79	\$27.70	\$25.62	\$23.83	8
		RG55, RG142, RG223, RG400, 11 GHz	PE44600	\$29.79	\$27.70	\$25.62	\$23.83	9
	Solder/Solder	PE-SR402AL, PE-SR402FL, RG402, 11 GHz, .141" Semi-Rigid	PE44604	\$39.32	\$36.57	\$33.82	\$31.46	10
<b>Female Straight, Bulkhead Mount, Cable Connectors</b>								
	Crimp/Solder	RG213, RG215, RG8, F02 Mounting Hole, 11 GHz	PE44607	\$36.93	\$34.34	\$31.76	\$29.54	11
		RG214, RG225, RG9, RG393, F02 Mounting Hole, 11 GHz	PE44608	\$36.93	\$34.34	\$31.76	\$29.54	12
		RG58, RG141, RG303, F02 Mounting Hole, 11 GHz	PE44606	\$27.92	\$25.97	\$24.01	\$22.34	13
		RG55, RG142, RG223, RG400, F02 Mounting Hole, 11 GHz	PE44605	\$27.36	\$25.44	\$23.53	\$21.89	14
	Solder/Solder	PE-SR402AL, PE-SR402FL, RG402, F02 Mounting Hole, 11 GHz, .141" Semi-Rigid	PE44609	\$36.93	\$34.34	\$31.76	\$29.54	15
<b>Female Straight, Panel Mount, Terminal</b>								
	Solder	4 Hole Flange, Solder Cup Contact, 11 GHz, D16 Mounting Hole	PE44610	\$54.87	\$51.03	\$47.19	\$43.90	16

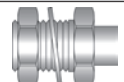
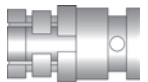
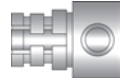
# SMP Connectors



Product Image	Attachment Cable/Contact	Coax Type / Termination Type	Model No.	Price				Row
				1-24	25-49	50-99	100 +	
<b>Male Straight, Bulkhead Mount, Cable Connectors</b>								
	Solder/Solder	PE-SR405AL, PE-SR405FL, RG405, Rear Mount, F11 Mounting Hole, .085" Semi-Rigid	PE44483	\$29.89	\$27.80	\$25.71	\$23.91	17
<b>Female Straight, Cable Connectors</b>								
	Solder/Solder	PE-047SR, PE-SR047AL, PE-SR047FL, .047" Semi-Rigid	PE44273	\$22.44	\$20.87	\$19.30	\$17.95	18
		PE-SR405AL, PE-SR405FL, RG405, .085" Semi-Rigid	PE44272	\$27.71	\$25.77	\$23.83	\$22.17	19
		RG178, RG196	PE44655	\$37.54	\$34.91	\$32.28	\$30.03	20
<b>Female Right Angle, Cable Connectors</b>								
	Solder/Solder	PE-047SR, PE-SR047AL, PE-SR047FL, .047" Semi-Rigid	PE44274	\$29.79	\$27.70	\$25.62	\$23.83	21
		PE-SR405AL, PE-SR405FL, RG405, .085" Semi-Rigid	PE44275	\$23.15	\$21.53	\$19.91	\$18.52	22
<b>Male Straight, PCB Mount</b>								
	Solder	Surface Mount, End Launch	PE44482	\$18.75	\$17.44	\$16.13	\$15.00	23
		Surface Mount	PE44481	\$25.89	\$24.08	\$22.27	\$20.71	24
		Thru Hole	PE44480	\$24.67	\$22.94	\$21.22	\$19.74	25
		Thru Hole, D03 Mounting Hole	PE44348	\$23.51	\$21.86	\$20.22	\$18.81	26

Connectors

See Our Website For Real-Time Stock Availability!



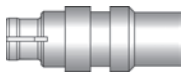



# MINI SMP Connectors

Product Image	Attachment Cable/Contact	Coax Type / Termination Type	Model No.	Price				Row
				1-24	25-49	50-99	100 +	
<b>Female Straight, Cable Connectors</b>								
	Solder	PE-047SR, PE-SR047AL, PE-SR047FL, 65 GHz, .047" Semi-Rigid	PE44491	\$27.36	\$25.44	\$23.53	\$21.89	1
		PE-SR405AL, PE-SR405FL, RG405, 65 GHz, .085" Semi-Rigid	PE44492	\$27.00	\$25.11	\$23.22	\$21.60	2
<b>Female Right Angle, Cable Connectors</b>								
	Solder	PE-047SR, PE-SR047AL, PE-SR047FL, 65 GHz, .047" Semi-Rigid	PE44493	\$31.11	\$28.93	\$26.75	\$24.89	3
		PE-SR405AL, PE-SR405FL, RG405, 65 GHz, .085" Semi-Rigid	PE44494	\$31.67	\$29.45	\$27.24	\$25.34	4
<b>Male Straight, PCB Mount</b>								
	Solder	Surface Mount, End Launch, 65 GHz	PE44490	\$18.75	\$17.44	\$16.13	\$15.00	5
		Surface Mount, 65 GHz	PE44489	\$25.89	\$24.08	\$22.27	\$20.71	6

# UMCX Connectors

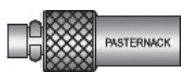
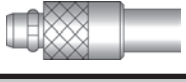
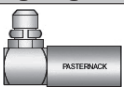
Product Image	Attachment Cable/Contact	Coax Type / Termination Type	Model No.	Price				Row
				1-24	25-49	50-99	100 +	
<b>Jack Straight, PCB Mount</b>								
	Solder	Surface Mount, 6 GHz	PE44594	\$1.11	\$1.03	\$0.95	\$0.89	7

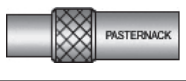
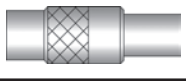

# MMCX Connectors

Product Image	Attachment Cable/Contact	Coax Type / Termination Type	Model No.	Price				Row
				1-24	25-49	50-99	100 +	
<b>Plug Straight, Cable Connectors</b>								
	Crimp/Solder	RG174, RG316, RG188	PE4896	\$12.16	\$11.31	\$10.46	\$9.73	8
		RG178, RG196	PE4897	\$11.86	\$11.03	\$10.20	\$9.49	9
		RG178, RG196, Easy Grip	PE44645	\$11.65	\$10.83	\$10.02	\$9.32	10
	Solder	PE-047SR, PE-SR047AL, PE-SR047FL, .047" Semi-Rigid	PE44456	\$16.16	\$15.03	\$13.90	\$12.93	11
		PE-SR405AL, PE-SR405FL, RG405, .085" Semi-Rigid	PE44453	\$12.97	\$12.06	\$11.15	\$10.38	12
<b>Plug Right Angle, Cable Connectors</b>								
	Crimp/Solder	RG174, RG316, RG188	PE4898	\$15.20	\$14.14	\$13.07	\$12.16	13
		RG178, RG196	PE4899	\$13.22	\$12.29	\$11.37	\$10.58	14
	Solder	PE-047SR, PE-SR047AL, PE-SR047FL, .047" Semi-Rigid	PE44457	\$17.18	\$15.98	\$14.77	\$13.74	15
		PE-SR405AL, PE-SR405FL, RG405, .085" Semi-Rigid	PE4900	\$13.22	\$12.29	\$11.37	\$10.58	16
<b>Jack Straight, Cable Connectors</b>								
	Crimp/Solder	RG174, RG316, RG188	PE4901	\$12.21	\$11.36	\$10.50	\$9.77	17
		RG178, RG196	PE4902	\$12.21	\$11.36	\$10.50	\$9.77	18
	Solder	PE-047SR, PE-SR047AL, PE-SR047FL, .047" Semi-Rigid	PE44459	\$22.34	\$20.78	\$19.21	\$17.87	19
		PE-SR405AL, PE-SR405FL, RG405, .085" Semi-Rigid	PE44458	\$16.16	\$15.03	\$13.90	\$12.93	20
<b>Plug Straight, PCB Mount</b>								
	Solder	Surface Mount, End Launch, Switching Connector	PE44663	\$15.05	\$14.00	\$12.94	\$12.04	21
		Surface Mount, Switching Connector	PE44662	\$15.05	\$14.00	\$12.94	\$12.04	22
		.028" Dia. Contact, .115" Leg Length, Thru Hole, D03 Mounting Hole	PE4905	\$21.13	\$19.65	\$18.17	\$16.90	23







Connectors

See Our Website For Real-Time Stock Availability!

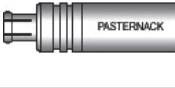
# MMCX Connectors

Product Image	Attachment Cable/Contact	Coax Type / Termination Type	Model No.	Price				Row
				1-24	25-49	50-99	100 +	
<b>Jack Straight, PCB Mount</b>								
	Solder	.028" Dia. Contact, .115" Leg Length, Thru Hole, D03 Mounting Hole	PE4904	\$9.73	\$9.05	\$8.37	\$7.78	1
<b>Jack Right Angle, PCB Mount</b>								
	Solder	.028" Dia. Contact, .115" Leg Length, Thru Hole, D03 Mounting Hole	PE4903	\$18.44	\$17.15	\$15.86	\$14.75	2

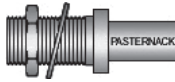
# MCX Connectors

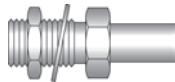
Product Image	Attachment Cable/Contact	Coax Type / Termination Type	Model No.	Price				Row
				1-24	25-49	50-99	100 +	
<b>Plug Straight, Cable Connectors</b>								
	Crimp/Solder	RG188-DS, RG316-DS	PE4878	\$9.60	\$8.93	\$8.26	\$7.68	3
		RG178, RG196	PE4552	\$12.72	\$11.83	\$10.94	\$10.18	4
		RG316, RG174, RG188	PE4551	\$9.73	\$9.05	\$8.37	\$7.78	5
		RG58	PE4880	\$14.75	\$13.72	\$12.69	\$11.80	6
		RG55, RG142, RG223, RG400	PE4881	\$20.27	\$18.85	\$17.43	\$16.22	7
	Solder	PE-SR405AL, PE-SR405FL, RG405, .085" Semi-Rigid	PE4876	\$17.28	\$16.07	\$14.86	\$13.82	8
<b>Plug Right Angle, Cable Connectors</b>								
	Crimp/Solder	RG188-DS, RG316-DS	PE4879	\$11.90	\$11.07	\$10.23	\$9.52	9
		RG174, RG316, RG188	PE4553	\$12.16	\$11.31	\$10.46	\$9.73	10
		RG178, RG196	PE4554	\$12.21	\$11.36	\$10.50	\$9.77	11
		RG58	PE4882	\$14.24	\$13.24	\$12.25	\$11.39	12
		RG55, RG142, RG223, RG400	PE4883	\$13.15	\$12.23	\$11.31	\$10.52	13
	Solder	PE-SR405AL, PE-SR405FL, RG405, .085" Semi-Rigid	PE4877	\$18.59	\$17.29	\$15.99	\$14.87	14
<b>Jack Straight, Cable Connectors</b>								
	Crimp/Solder	RG188-DS, RG316-DS	PE4885	\$12.50	\$11.63	\$10.75	\$10.00	15
		RG174, RG316, RG188	PE4562	\$16.00	\$14.88	\$13.76	\$12.80	16
		RG178, RG196	PE4884	\$14.29	\$13.29	\$12.29	\$11.43	17
<b>Jack Straight, Bulkhead Mount, Cable Connectors</b>								
	Crimp/Solder	RG188-DS, RG316-DS, B01 Mounting Hole	PE4888	\$13.15	\$12.23	\$11.31	\$10.52	18
		RG174, RG316, RG188, B01 Mounting Hole	PE4887	\$14.74	\$13.71	\$12.68	\$11.79	19
		RG178, RG196, B01 Mounting Hole	PE4886	\$24.49	\$22.78	\$21.06	\$19.59	20
<b>Reverse Polarity Plug Straight, Cable Connectors</b>								
	Crimp/Solder	RG174, RG316, RG188	PE44369	\$18.59	\$17.29	\$15.99	\$14.87	21
		RG178, RG196	PE44370	\$18.59	\$17.29	\$15.99	\$14.87	22
<b>Reverse Polarity Plug Right Angle, Cable Connectors</b>								
	Crimp/Solder	RG174, RG316, RG188	PE44371	\$21.13	\$19.65	\$18.17	\$16.90	23
		RG178, RG196	PE44372	\$21.13	\$19.65	\$18.17	\$16.90	24
<b>Reverse Polarity Jack Straight, Bulkhead Mount, Cable Connectors</b>								
	Crimp/Solder	RG174, RG316, RG188, B01 Mounting Hole	PE44373	\$23.66	\$22.00	\$20.35	\$18.93	25
		RG178, RG196, B01 Mounting Hole	PE44374	\$23.66	\$22.00	\$20.35	\$18.93	26

Connectors

See Our Website For Real-Time Stock Availability!











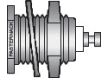
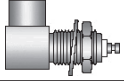

# MCX Connectors

Connectors







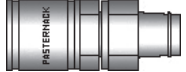

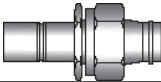

See Our Website For Real-Time Stock Availability!

Product Image	Attachment Cable/Contact	Coax Type / Termination Type	Model No.	Price				Row
				1-24	25-49	50-99	100 +	
<b>Jack Straight, Bulkhead Mount, Terminal</b>								
	Solder	Turret, .118" Max Panel, B01 Mounting Hole	PE4561	\$12.21	\$11.36	\$10.50	\$9.77	1
<b>Jack Right Angle, Bulkhead Mount, Terminal</b>								
	Solder	Turret, .118" Max Panel, B01 Mounting Hole	PE4560	\$29.94	\$27.84	\$25.75	\$23.95	2
<b>Jack Straight, Panel Mount, Terminal</b>								
	Solder	2 Hole Flange, .038" Dia. Contact, .200" Extended Dielectric, C03 Mounting Hole	PE4894	\$13.68	\$12.72	\$11.76	\$10.94	3
		2 Hole Flange, Solder Cup Contact, C03 Mounting Hole	PE4891	\$15.05	\$14.00	\$12.94	\$12.04	4
		4 Hole Flange, Solder Cup Contact, A17 Mounting Hole	PE4895	\$24.88	\$23.14	\$21.40	\$19.90	5
<b>Plug Straight, PCB Mount</b>								
	Solder	Surface Mount, End Launch, Switching Connector	PE44661	\$15.05	\$14.00	\$12.94	\$12.04	6
		Surface Mount, Switching Connector	PE44660	\$15.05	\$14.00	\$12.94	\$12.04	7
		Surface Mount	PE44613	\$10.74	\$9.99	\$9.24	\$8.59	8
		.036" Dia. Contact, .155" Leg Length, Thru Hole, D04 Mounting Hole	PE4559	\$14.03	\$13.05	\$12.07	\$11.22	9
<b>Jack Straight, PCB Mount</b>								
	Solder	.042 End Launch, .019" Round Contact, .125" Leg Length	PE4893	\$13.68	\$12.72	\$11.76	\$10.94	10
		.062" End Launch, .019" Round Contact, .125" Leg Length	PE4892	\$17.58	\$16.35	\$15.12	\$14.06	11
		Surface Mount	PE4889	\$10.34	\$9.62	\$8.89	\$8.27	12
		.038" Dia. Contact, .155" Leg Length, Thru Hole, D04 Mounting Hole	PE4555	\$8.51	\$7.91	\$7.32	\$6.81	13
<b>Jack Right Angle, PCB Mount</b>								
	Solder	Surface Mount	PE4890	\$17.28	\$16.07	\$14.86	\$13.82	14
		.036" Dia. Contact, .155" Leg Length, Thru Hole, D04 Mounting Hole	PE4556	\$11.10	\$10.32	\$9.55	\$8.88	15
<b>Reverse Polarity Jack Straight, PCB Mount</b>								
	Solder	.038" Dia. Contact, .155" Leg Length, Thru Hole, D02 Mounting Hole	PE44375	\$11.20	\$10.42	\$9.63	\$8.96	16
<b>Reverse Polarity Jack Straight, Bulkhead Mount, PCB Mount</b>								
	Solder	Surface Mount, End Launch, .019" Dia. Contact, .125" Leg Length, B01 Mounting Hole	PE44377	\$18.59	\$17.29	\$15.99	\$14.87	17
<b>Reverse Polarity Jack Right Angle, Bulkhead Mount, PCB Mount</b>								
	Solder	.038" Dia. Contact, .155" Leg Length, Thru Hole, D02 & B01 Mounting Hole	PE44376	\$24.88	\$23.14	\$21.40	\$19.90	18

# SMB Connectors (These Connectors will not mate to Standard 75 Ohm SMB Connectors)

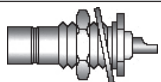
Product Image	Attachment Cable/Contact	Coax Type / Termination Type	Model No.	Price				Row
				1-24	25-49	50-99	100 +	
<b>Plug Straight, Cable Connectors</b>								
	Crimp/Solder	RG174, RG316, RG188	PE4046	\$9.12	\$8.48	\$7.84	\$7.30	19
		RG178, RG196	PE4080	\$12.59	\$11.71	\$10.83	\$10.07	20
		RG58	PE4523	\$13.58	\$12.63	\$11.68	\$10.86	21
		RG55, RG142, RG223, RG400	PE4593	\$13.15	\$12.23	\$11.31	\$10.52	22
	Clamp/Solder	PE-SR405AL, PE-SR405FL, RG405, .085" Semi-Rigid	PE4356	\$10.80	\$10.04	\$9.29	\$8.64	23
		RG174, RG316, RG188	PE4200	\$11.91	\$11.08	\$10.24	\$9.53	24
		RG178, RG196	PE4250	\$15.30	\$14.23	\$13.16	\$12.24	25

# SMB Connectors (These Connectors will not mate to Standard 75 Ohm SMB Connectors)

Product Image	Attachment Cable/Contact	Coax Type / Termination Type	Model No.	Price				Row
				1-24	25-49	50-99	100 +	
<b>Plug Right Angle, Cable Connectors</b>								
	Crimp/Solder	RG174, RG316, RG188	PE4052	\$12.26	\$11.40	\$10.54	\$9.81	1
		RG178, RG196	PE4159	\$12.21	\$11.36	\$10.50	\$9.77	2
		RG58	PE4522	\$15.96	\$14.84	\$13.73	\$12.77	3
		RG55, RG142, RG223, RG400	PE4595	\$15.60	\$14.51	\$13.42	\$12.48	4
	Clamp/Solder	PE-SR405AL, PE-SR405FL, RG405, .085" Semi-Rigid	PE4358	\$12.85	\$11.95	\$11.05	\$10.28	5
		RG174, RG316, RG188	PE4260	\$32.37	\$30.10	\$27.84	\$25.90	6
		RG178, RG196	PE4261	\$32.37	\$30.10	\$27.84	\$25.90	7
<b>Jack Straight, Cable Connectors</b>								
	Crimp/Solder	RG174, RG316, RG188	PE4096	\$10.28	\$9.56	\$8.84	\$8.22	8
		RG178, RG196	PE4926	\$18.75	\$17.44	\$16.13	\$15.00	9
	Clamp/Solder	PE-SR405AL, PE-SR405FL, RG405, .085" Semi-Rigid	PE4360	\$13.40	\$12.46	\$11.52	\$10.72	10
		RG174, RG316, RG188	PE4268	\$11.86	\$11.03	\$10.20	\$9.49	11
		RG178, RG196	PE4269	\$17.63	\$16.40	\$15.16	\$14.10	12
<b>Jack Straight, Bulkhead Mount, Cable Connectors</b>								
	Crimp/Solder	RG174, RG316, RG188, B01 Mounting Hole	PE4097	\$11.70	\$10.88	\$10.06	\$9.36	13
		RG178, RG196, B01 Mounting Hole	PE4364	\$11.30	\$10.51	\$9.72	\$9.04	14
		RG58, B01 Mounting Hole	PE44094	\$21.25	\$19.76	\$18.28	\$17.00	15
		RG55, RG142, RG223, RG400, B01 Mounting Hole	PE44048	\$23.51	\$21.86	\$20.22	\$18.81	16
	Clamp/Solder	PE-SR405AL, PE-SR405FL, RG405, B01 Mounting Hole, .085" Semi-Rigid	PE4362	\$13.43	\$12.49	\$11.55	\$10.74	17
		RG174, RG316, RG188, B01 Mounting Hole	PE4276	\$12.41	\$11.54	\$10.67	\$9.93	18
		RG178, RG196, B01 Mounting Hole	PE4277	\$12.41	\$11.54	\$10.67	\$9.93	19
<b>Plug Straight, Bulkhead Mount, Terminal</b>								
	Solder	Solder Cup Contact, Front Mount, .180" Max Panel, B01 Mounting Hole	PE4288	\$11.96	\$11.12	\$10.29	\$9.57	20
<b>Jack Straight, Bulkhead Mount, Terminal</b>								
	Solder	Solder Cup Contact, Front Mount, B01 Mounting Hole	PE4170	\$10.59	\$9.85	\$9.11	\$8.47	21
		Solder Cup Contact, Rear Mount, B01 Mounting Hole	PE4167	\$5.19	\$4.83	\$4.46	\$4.15	22
<b>Jack Right Angle, Bulkhead Mount, Terminal</b>								
	Solder	Solder Cup Contact, Front Mount, .093" Max Panel, B01 Mounting Hole	PE4284	\$24.02	\$22.34	\$20.66	\$19.22	23
<b>Jack Straight, Panel Mount, Terminal</b>								
	Solder	2 Hole Flange, Solder Cup Contact, C07 Mounting Hole	PE44139	\$18.59	\$17.29	\$15.99	\$14.87	24
		4 Hole Flange, Solder Cup Contact, A22 Mounting Hole	PE44142	\$18.59	\$17.29	\$15.99	\$14.87	25
<b>Plug Straight, PCB Mount</b>								
	Solder	.038" Dia. Contact, .155" Leg Length, Thru Hole, D02 Mounting Hole	PE4366	\$14.39	\$13.38	\$12.38	\$11.51	26
<b>Plug Right Angle, PCB Mount</b>								
	Solder	.037" Dia. Contact, .155" Leg Length, Thru Hole, D02 Mounting Hole	PE4245	\$14.34	\$13.34	\$12.33	\$11.47	27

Connectors

See Our Website For Real-Time Stock Availability!



# SMB Connectors (These Connectors will not mate to Standard 75 Ohm SMB Connectors)

Product Image	Attachment Cable/Contact	Coax Type / Termination Type	Model No.	Price				Row
				1-24	25-49	50-99	100 +	
<b>Jack Straight, PCB Mount</b>								
	Solder	.042" End Launch, .030" Round Contact, .187" Leg Length	PE44132	\$17.63	\$16.40	\$15.16	\$14.10	1
		.042" End Launch, .020" x .010" Tab Contact, .187" Leg Length	PE44137	\$16.72	\$15.55	\$14.38	\$13.38	2
		.062" End Launch, .020" x .010" Tab Contact, .187" Leg Length	PE44135	\$17.47	\$16.25	\$15.02	\$13.98	3
		.062" End Launch, .030" Dia Contact, .187" Leg Length	PE44129	\$15.05	\$14.00	\$12.94	\$12.04	4
		Surface Mount	PE44119	\$6.43	\$5.98	\$5.53	\$5.14	5
<b>Jack Right Angle, PCB Mount</b>								
	Solder	Surface Mount	PE44121	\$15.45	\$14.37	\$13.29	\$12.36	6
<b>Jack Straight, PCB Mount</b>								
	Solder	.037" Dia. Contact, .155" Leg Length, Thru Hole, D02 Mounting Hole	PE4174	\$5.14	\$4.78	\$4.42	\$4.11	7
<b>Jack Right Angle, PCB Mount</b>								
	Solder	.038" Dia. Contact, .155" Leg Length, Thru Hole, D02 Mounting Hole	PE4177	\$8.61	\$8.01	\$7.40	\$6.89	8
<b>Jack Straight, Bulkhead Mount, PCB Mount</b>								
	Solder	.038" Dia. Contact, .155" Leg Length, Thru Hole, .093" Max Panel, B01 & D02 Mounting Hole	PE44123	\$13.83	\$12.86	\$11.89	\$11.06	9
<b>Jack Right Angle, Bulkhead Mount, PCB Mount</b>								
	Solder	.038" Dia. Contact, .155" Leg Length, .093" Max Panel, Thru Hole, B01 & D02 Mounting Hole	PE44126	\$15.81	\$14.70	\$13.60	\$12.65	10



# SSMB Connectors

Product Image	Attachment Cable/Contact	Coax Type / Termination Type	Model No.	Price				Row
				1-24	25-49	50-99	100 +	
<b>Plug Straight, Cable Connectors</b>								
	Crimp/Solder	RG174, RG179, RG316, RG188	PE4017	\$22.09	\$20.54	\$19.00	\$17.67	11
		RG178, RG196	PE4019	\$20.27	\$18.85	\$17.43	\$16.22	12
<b>Plug Right Angle, Cable Connectors</b>								
	Crimp/Solder	RG174, RG316, RG188	PE4334	\$19.96	\$18.56	\$17.17	\$15.97	13
		RG178, RG196	PE4335	\$14.24	\$13.24	\$12.25	\$11.39	14
<b>Jack Straight, Bulkhead Mount, Cable Connectors</b>								
	Crimp/Solder	RG174, RG316, RG188, B10 Mounting Hole	PE4336	\$24.88	\$23.14	\$21.40	\$19.90	15
		RG178, RG196, B10 Mounting Hole	PE4337	\$24.88	\$23.14	\$21.40	\$19.90	16
<b>Jack Straight, Bulkhead Mount, Terminal</b>								
	Solder	Turret, Rear Mount, B10 Mounting Hole	PE4338	\$18.59	\$17.29	\$15.99	\$14.87	17
		Turret, Front Mount, B10 Mounting Hole	PE4339	\$19.30	\$17.95	\$16.60	\$15.44	18
<b>Jack Straight, Panel Mount, Terminal</b>								
	Solder	4 Hole Flange, Tab, .005" X .028" Tab Contact, D15 Mounting Hole	PE44455	\$18.75	\$17.44	\$16.13	\$15.00	19



Connectors

See Our Website For Real-Time Stock Availability!

# SSMB Connectors

Product Image	Attachment Cable/Contact	Coax Type / Termination Type	Model No.	Price				Row
				1-24	25-49	50-99	100 +	
<b>Jack Straight, PCB Mount</b>								
	Solder	.025" Dia. Contact, .155" Leg Length, Thru Hole, D03 Mounting Hole	PE4340	\$9.73	\$9.05	\$8.37	\$7.78	1
<b>Jack Right Angle, PCB Mount</b>								
	Solder	.025" Dia. Contact, .155" Leg Length, Thru Hole, D03 Mounting Hole	PE4341	\$15.30	\$14.23	\$13.16	\$12.24	2

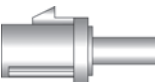
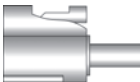
# FAKRA Connectors

Product Image	Attachment Cable/Contact	Coax Type / Termination Type	Model No.	Price				Row
				1-24	25-49	50-99	100 +	
<b>Plug Straight, Cable Connectors</b>								
	Crimp/Solder	PE-C100, RG174, RG316, Black Color, Radio with Phantom Supply	PE44647A	\$4.26	\$3.96	\$3.66	\$3.41	3
		PE-C100, RG174, RG316, White Color, Radio without Phantom Supply	PE44647B	\$4.26	\$3.96	\$3.66	\$3.41	4
		PE-C100, RG174, RG316, Blue Color, GPS: Telematics or Navigation	PE44647C	\$4.26	\$3.96	\$3.66	\$3.41	5
		PE-C100, RG174, RG316, Bordeaux Color, GSM: Cellular Phone	PE44647D	\$4.26	\$3.96	\$3.66	\$3.41	6
		PE-C100, RG174, RG316, Violet Color, GPS: Telematics and Navigation	PE44647H	\$4.26	\$3.96	\$3.66	\$3.41	7
		PE-C100, RG174, RG316, Beige Color, Bluetooth	PE44647I	\$4.26	\$3.96	\$3.66	\$3.41	8
		PE-C100, RG174, RG316, Curry Color, Radio with I.F. Output (Antenna Diversity)	PE44647K	\$4.26	\$3.96	\$3.66	\$3.41	9
		PE-C100, RG174, RG316, Water Blue Color, Neutral Coding	PE44647Z	\$4.26	\$3.96	\$3.66	\$3.41	10
<b>Jack Straight, Cable Connectors</b>								
	Crimp/Solder	PE-C100, RG174, RG316, Black Color, Radio with Phantom Supply	PE44646A	\$4.26	\$3.96	\$3.66	\$3.41	11
		PE-C100, RG174, RG316, White Color, Radio without Phantom Supply	PE44646B	\$4.26	\$3.96	\$3.66	\$3.41	12
		PE-C100, RG174, RG316, Blue Color, GPS: Telematics or Navigation	PE44646C	\$4.26	\$3.96	\$3.66	\$3.41	13
		PE-C100, RG174, RG316, Bordeaux Color, GSM: Cellular Phone	PE44646D	\$4.26	\$3.96	\$3.66	\$3.41	14
		PE-C100, RG174, RG316, Violet Color, GPS: Telematics and Navigation	PE44646H	\$4.26	\$3.96	\$3.66	\$3.41	15
		PE-C100, RG174, RG316, Beige Color, Bluetooth	PE44646I	\$4.26	\$3.96	\$3.66	\$3.41	16
		PE-C100, RG174, RG316, Curry Color, Radio with I.F. Output (Antenna Diversity)	PE44646K	\$4.26	\$3.96	\$3.66	\$3.41	17
		PE-C100, RG174, RG316, Water Blue Color, Neutral Coding	PE44646Z	\$4.26	\$3.96	\$3.66	\$3.41	18
<b>Jack Right Angle, Cable Connectors</b>								
	Crimp/Solder	PE-C100, RG174, RG316, Black Color, Radio with Phantom Supply	PE44648A	\$5.32	\$4.95	\$4.58	\$4.26	19
		PE-C100, RG174, RG316, White Color, Radio without Phantom Supply	PE44648B	\$5.32	\$4.95	\$4.58	\$4.26	20
		PE-C100, RG174, RG316, Blue Color, GPS: Telematics or Navigation	PE44648C	\$5.32	\$4.95	\$4.58	\$4.26	21
		PE-C100, RG174, RG316, Bordeaux Color, GSM: Cellular Phone	PE44648D	\$5.32	\$4.95	\$4.58	\$4.26	22
		PE-C100, RG174, RG316, Violet Color, GPS: Telematics and Navigation	PE44648H	\$5.32	\$4.95	\$4.58	\$4.26	23
		PE-C100, RG174, RG316, Beige Color, Bluetooth	PE44648I	\$5.32	\$4.95	\$4.58	\$4.26	24
		PE-C100, RG174, RG316, Curry Color, Radio with I.F. Output (Antenna Diversity)	PE44648K	\$5.32	\$4.95	\$4.58	\$4.26	25
		PE-C100, RG174, RG316, Water Blue Color, Neutral Coding	PE44648Z	\$5.32	\$4.95	\$4.58	\$4.26	26
<b>Plug Straight, PCB Mount</b>								
	Solder	.039" Dia. Contact, .155" Leg Length, Thru Hole, Black Color, Radio with Phantom Supply, D02 Mounting Hole	PE44649A	\$4.26	\$3.96	\$3.66	\$3.41	27
		.039" Dia. Contact, .155" Leg Length, Thru Hole, White Color, Radio without Phantom Supply, D02 Mounting Hole	PE44649B	\$4.26	\$3.96	\$3.66	\$3.41	28
		.039" Dia. Contact, .155" Leg Length, Thru Hole, Blue Color, GPS: Telematics or Navigation, D02 Mounting Hole	PE44649C	\$4.26	\$3.96	\$3.66	\$3.41	29
		.039" Dia. Contact, .155" Leg Length, Thru Hole, Bordeaux Color, GSM: Cellular Phone, D02 Mounting Hole	PE44649D	\$4.26	\$3.96	\$3.66	\$3.41	30
		.039" Dia. Contact, .155" Leg Length, Thru Hole, D02 Mounting Hole, Violet Color, GPS: Telematics and Navigation	PE44649H	\$4.26	\$3.96	\$3.66	\$3.41	31
		.039" Dia. Contact, .155" Leg Length, Thru Hole, Beige Color, Bluetooth, D02 Mounting Hole	PE44649I	\$4.26	\$3.96	\$3.66	\$3.41	32
		.039" Dia. Contact, .155" Leg Length, Thru Hole, Curry Color, Radio with I.F. Output (Antenna Diversity), D02 Mounting Hole	PE44649K	\$4.26	\$3.96	\$3.66	\$3.41	33
		.039" Dia. Contact, .155" Leg Length, Thru Hole, D02 Mounting Hole, Water Blue Color, Neutral Coding	PE44649Z	\$4.26	\$3.96	\$3.66	\$3.41	34

Connectors

See Our Website For Real-Time Stock Availability!





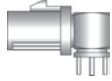

# FAKRA Connectors

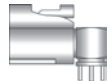
Connectors

Product Image	Attachment Cable/Contact	Coax Type / Termination Type	Model No.	Price				Row
				1-24	25-49	50-99	100 +	
<b>Plug Right Angle, PCB Mount</b>								
	Solder	.036" Dia. Contact, .138" Leg Length, Thru Hole, Black Color, Radio with Phantom Supply, D07 Mounting Hole	PE44651A	\$5.32	\$4.95	\$4.58	\$4.26	1
		.036" Dia. Contact, .138" Leg Length, Thru Hole, White Color, Radio without Phantom Supply, D07 Mounting Hole	PE44651B	\$5.32	\$4.95	\$4.58	\$4.26	2
		.036" Dia. Contact, .138" Leg Length, Thru Hole, Blue Color, GPS: Telematics or Navigation, D07 Mounting Hole	PE44651C	\$5.32	\$4.95	\$4.58	\$4.26	3
		.036" Dia. Contact, .138" Leg Length, Thru Hole, Bordeaux Color, GSM: Cellular Phone, D07 Mounting Hole	PE44651D	\$5.32	\$4.95	\$4.58	\$4.26	4
		.036" Dia. Contact, .138" Leg Length, Thru Hole, D07 Mounting Hole, Violet Color, GPS: Telematics and Navigation	PE44651H	\$5.32	\$4.95	\$4.58	\$4.26	5
		.036" Dia. Contact, .138" Leg Length, Thru Hole, Beige Color, Bluetooth, D07 Mounting Hole	PE44651I	\$5.32	\$4.95	\$4.58	\$4.26	6
		.036" Dia. Contact, .138" Leg Length, Thru Hole, Curry Color, Radio with I.F. Output (Antenna Diversity), D07 Mounting Hole	PE44651K	\$5.32	\$4.95	\$4.58	\$4.26	7
		.036" Dia. Contact, .138" Leg Length, Thru Hole, Water Blue Color, Neutral Coding, D07 Mounting Hole	PE44651Z	\$5.32	\$4.95	\$4.58	\$4.26	8

<b>Jack Right Angle, PCB Mount</b>								
	Solder	.036" Dia. Contact, .138" Leg Length, Thru Hole, Black Color, Radio with Phantom Supply, D07 Mounting Hole	PE44650A	\$5.88	\$5.47	\$5.06	\$4.70	9
		.036" Dia. Contact, .138" Leg Length, Thru Hole, White Color, Radio without Phantom Supply, D07 Mounting Hole	PE44650B	\$5.88	\$5.47	\$5.06	\$4.70	10
		.036" Dia. Contact, .138" Leg Length, Thru Hole, Blue Color, GPS: Telematics or Navigation, D07 Mounting Hole	PE44650C	\$5.88	\$5.47	\$5.06	\$4.70	11
		.036" Dia. Contact, .138" Leg Length, Thru Hole, Bordeaux Color, GSM: Cellular Phone, D07 Mounting Hole	PE44650D	\$5.88	\$5.47	\$5.06	\$4.70	12
		.036" Dia. Contact, .138" Leg Length, Thru Hole, D07 Mounting Hole, Violet Color, GPS: Telematics and Navigation	PE44650H	\$5.88	\$5.47	\$5.06	\$4.70	13
		.036" Dia. Contact, .138" Leg Length, Thru Hole, Beige Color, Bluetooth, D07 Mounting Hole	PE44650I	\$5.88	\$5.47	\$5.06	\$4.70	14
		.036" Dia. Contact, .138" Leg Length, Thru Hole, Curry Color, Radio with I.F. Output (Antenna Diversity), D07 Mounting Hole	PE44650K	\$5.88	\$5.47	\$5.06	\$4.70	15
		.036" Dia. Contact, .138" Leg Length, Thru Hole, Water Blue Color, Neutral Coding, D07 Mounting Hole	PE44650Z	\$5.88	\$5.47	\$5.06	\$4.70	16

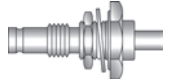
## 1.0/2.3 Connectors



Product Image	Attachment Cable/Contact	Coax Type / Termination Type	Model No.	Price				Row
				1-24	25-49	50-99	100 +	
<b>Plug Straight, Cable Connectors</b>								
	Crimp/Solder	RG174, RG316, RG188, Snap On	PE44244	\$9.70	\$9.02	\$8.34	\$7.76	17
		RG58, Snap On	PE44243	\$9.63	\$8.96	\$8.28	\$7.70	18
		RG55, RG142, RG223, RG400, Snap On	PE44242	\$9.05	\$8.42	\$7.78	\$7.24	19
<b>Plug Right Angle, Cable Connectors</b>								
	Crimp/Solder	RG174, RG316, RG188, Snap On	PE44249	\$11.70	\$10.88	\$10.06	\$9.36	20
		RG58, Snap On	PE44248	\$12.41	\$11.54	\$10.67	\$9.93	21
		RG55, RG142, RG223, RG400, Snap On	PE44247	\$11.25	\$10.46	\$9.68	\$9.00	22
<b>Jack Straight, Bulkhead Mount, Cable Connectors</b>								
	Crimp/Solder	RG174, RG316, RG188, Snap On, G06 Mounting Hole	PE44254	\$11.20	\$10.42	\$9.63	\$8.96	23
	Solder/Solder	PE-SR402AL, PE-SR402FL, RG402, Snap On, B02 Mounting Hole, .141" Semi-Rigid	PE44255	\$12.41	\$11.54	\$10.67	\$9.93	24
		PE-SR405AL, PE-SR405FL, RG405, Snap On, B02 Mounting Hole, .085" Semi-Rigid	PE44256	\$12.41	\$11.54	\$10.67	\$9.93	25
<b>Jack Right Angle, Bulkhead Mount, Cable Connectors</b>								
	Crimp/Solder	RG174, RG316, RG188, G05 Mounting Hole, Snap On	PE44261	\$12.97	\$12.06	\$11.15	\$10.38	26
		RG58, G05 Mounting Hole, Snap On	PE44260	\$12.97	\$12.06	\$11.15	\$10.38	27

See Our Website For Real-Time Stock Availability!

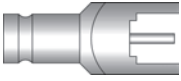
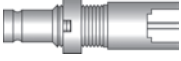
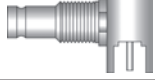

# 1.0/2.3 Connectors

Product Image	Attachment Cable/Contact	Coax Type / Termination Type	Model No.	Price				Row
				1-24	25-49	50-99	100 +	
<b>Jack Straight, PCB Mount</b>								
	Solder	.033" Dia. Contact, .138" Leg Length, Thru Hole, D07 Mounting Hole, Snap On	PE44257	\$6.43	\$5.98	\$5.53	\$5.14	1
<b>Jack Straight, Bulkhead Mount, PCB Mount</b>								
	Solder	.039" Dia. Contact, .138" Leg Length, Thru Hole, D07 & F09 Mounting Hole, Snap On	PE44259	\$9.07	\$8.44	\$7.80	\$7.26	2
<b>Jack Right Angle, PCB Mount</b>								
	Solder	.037" Dia. Contact, .142" Leg Length, Thru Hole, D07 Mounting Hole, Snap On	PE44258	\$8.56	\$7.96	\$7.36	\$6.85	3

# MC-CARD Connectors

Product Image	Attachment Cable/Contact	Coax Type / Termination Type	Model No.	Price				Row
				1-24	25-49	50-99	100 +	
<b>Plug Straight, Cable Connectors</b>								
	Crimp/Solder	RG174, RG316, RG188	PE44309	\$9.07	\$8.44	\$7.80	\$7.26	4
		RG178, RG196	PE44310	\$9.07	\$8.44	\$7.80	\$7.26	5
<b>Plug Right Angle, Cable Connectors</b>								
	Crimp/Solder	RG174, RG316, RG188	PE44308	\$9.73	\$9.05	\$8.37	\$7.78	6
		RG178, RG196	PE44311	\$10.34	\$9.62	\$8.89	\$8.27	7

# D-Sub Contacts

Product Image	Attachment Cable/Contact	Coax Type / Termination Type	Model No.	Price				Row		
				1-24	25-49	50-99	100 +			
<b>Plug Straight, Cable Connectors</b>										
	Crimp/Solder	RG174, RG316, RG187, RG188	PE4809	\$11.43	\$10.63	\$9.83	\$9.14	8		
		RG178, RG196	PE4810	\$11.60	\$10.79	\$9.98	\$9.28	9		
		RG180, RG195	PE4811	\$11.60	\$10.79	\$9.98	\$9.28	10		
		RG58, RG141, RG303	PE4808	\$11.60	\$10.79	\$9.98	\$9.28	11		
		RG55, RG142, RG223, RG400	PE4842	\$11.70	\$10.88	\$10.06	\$9.36	12		
	Solder/Solder	PE-047SR, PE-SR047AL, PE-SR047FL, .047" Semi-Rigid	PE4846	\$15.60	\$14.51	\$13.42	\$12.48	13		
		PE-SR402AL, PE-SR402FL, RG402, .141" Semi-Rigid	PE4844	\$16.16	\$15.03	\$13.90	\$12.93	14		
		PE-SR405AL, PE-SR405FL, RG405, .085" Semi-Rigid	PE4845	\$14.24	\$13.24	\$12.25	\$11.39	15		
		RG174, RG316, RG187, RG188	PE4813	\$11.30	\$10.51	\$9.72	\$9.04	16		
		RG178, RG196	PE4814	\$10.60	\$9.86	\$9.12	\$8.48	17		
		RG180, RG195	PE4815	\$11.60	\$10.79	\$9.98	\$9.28	18		
		RG58, RG141, RG303	PE4812	\$10.60	\$9.86	\$9.12	\$8.48	19		
		RG55, RG142, RG223, RG400	PE4843	\$11.70	\$10.88	\$10.06	\$9.36	20		
		<b>Plug Right Angle, Cable Connectors</b>								
			Crimp/Solder	RG174, RG316, RG187, RG188	PE4825	\$11.60	\$10.79	\$9.98	\$9.28	21
RG178, RG196	PE4826			\$11.60	\$10.79	\$9.98	\$9.28	22		
RG180, RG195	PE4827			\$11.60	\$10.79	\$9.98	\$9.28	23		
RG58, RG141, RG303	PE4824			\$11.60	\$10.79	\$9.98	\$9.28	24		
RG55, RG142, RG223, RG400	PE44035			\$11.90	\$11.07	\$10.23	\$9.52	25		







Connectors

See Our Website For Real-Time Stock Availability!

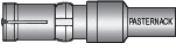
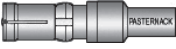
# D-Sub Contacts

Connectors

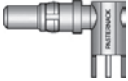
See Our Website For Real-Time Stock Availability!

Product Image	Attachment Cable/Contact	Coax Type / Termination Type	Model No.	Price				Row
				1-24	25-49	50-99	100 +	
	Solder/Solder	PE-047SR, PE-SR047AL, PE-SR047FL, .047" Semi-Rigid	PE44039	\$22.09	\$20.54	\$19.00	\$17.67	1
		PE-SR402AL, PE-SR402FL, RG402, .141" Semi-Rigid	PE44037	\$20.77	\$19.32	\$17.86	\$16.62	2
		PE-SR405AL, PE-SR405FL, RG405, .085" Semi-Rigid	PE44038	\$20.77	\$19.32	\$17.86	\$16.62	3
		RG174, RG316, RG187, RG188	PE4829	\$11.60	\$10.79	\$9.98	\$9.28	4
		RG178, RG196	PE4830	\$11.60	\$10.79	\$9.98	\$9.28	5
		RG180, RG195	PE4831	\$11.60	\$10.79	\$9.98	\$9.28	6
		RG58, RG141, RG303	PE4828	\$11.60	\$10.79	\$9.98	\$9.28	7
		RG55, RG142, RG223, RG400	PE44036	\$11.70	\$10.88	\$10.06	\$9.36	8
<b>Receptacle Straight, Cable Connectors</b>								
	Crimp/Solder	RG174, RG316, RG187, RG188	PE4801	\$11.59	\$10.78	\$9.97	\$9.27	9
		RG178, RG196	PE4802	\$9.07	\$8.44	\$7.80	\$7.26	10
		RG180, RG195	PE4803	\$9.07	\$8.44	\$7.80	\$7.26	11
		RG58, RG141, RG303	PE4800	\$11.59	\$10.78	\$9.97	\$9.27	12
		RG55, RG142, RG223, RG400	PE4837	\$9.60	\$8.93	\$8.26	\$7.68	13
	Solder/Solder	PE-047SR, PE-SR047AL, PE-SR047FL, .047" Semi-Rigid	PE4841	\$12.97	\$12.06	\$11.15	\$10.38	14
		PE-SR402AL, PE-SR402FL, RG402, .141" Semi-Rigid	PE4839	\$16.16	\$15.03	\$13.90	\$12.93	15
		PE-SR405AL, PE-SR405FL, RG405, .085" Semi-Rigid	PE4840	\$11.60	\$10.79	\$9.98	\$9.28	16
		RG174, RG316, RG187, RG188	PE4805	\$9.07	\$8.44	\$7.80	\$7.26	17
		RG178, RG196	PE4806	\$9.07	\$8.44	\$7.80	\$7.26	18
		RG180, RG195	PE4807	\$9.07	\$8.44	\$7.80	\$7.26	19
		RG58, RG141, RG303	PE4804	\$9.07	\$8.44	\$7.80	\$7.26	20
		RG55, RG142, RG223, RG400	PE4838	\$9.45	\$8.79	\$8.13	\$7.56	21
<b>Receptacle Right Angle, Cable Connectors</b>								
	Crimp/Solder	RG174, RG316, RG187, RG188	PE4817	\$23.15	\$21.53	\$19.91	\$18.52	22
		RG178, RG196	PE4818	\$11.60	\$10.79	\$9.98	\$9.28	23
		RG180, RG195	PE4819	\$10.60	\$9.86	\$9.12	\$8.48	24
		RG58, RG141, RG303	PE4816	\$11.60	\$10.79	\$9.98	\$9.28	25
		RG55, RG142, RG223, RG400	PE4847	\$11.70	\$10.88	\$10.06	\$9.36	26
	Solder/Solder	PE-047SR, PE-SR047AL, PE-SR047FL, .047" Semi-Rigid	PE44034	\$18.24	\$16.96	\$15.69	\$14.59	27
		PE-SR402AL, PE-SR402FL, RG402, .141" Semi-Rigid	PE4849	\$16.87	\$15.69	\$14.51	\$13.50	28
		PE-SR405AL, PE-SR405FL, RG405, .085" Semi-Rigid	PE44033	\$16.87	\$15.69	\$14.51	\$13.50	29
		RG174, RG316, RG187, RG188	PE4821	\$11.60	\$10.79	\$9.98	\$9.28	30
		RG178, RG196	PE4822	\$11.60	\$10.79	\$9.98	\$9.28	31
		RG180, RG195	PE4823	\$11.60	\$10.79	\$9.98	\$9.28	32
		RG58, RG141, RG303	PE4820	\$10.60	\$9.86	\$9.12	\$8.48	33
		RG55, RG142, RG223, RG400	PE4848	\$11.70	\$10.88	\$10.06	\$9.36	34
<b>Plug Straight, PCB Mount</b>								
	Solder	.031" Dia. Contact, .170" Leg Length, Thru Hole, J01 Mounting Hole	PE4833	\$12.16	\$11.31	\$10.46	\$9.73	35
<b>Plug Right Angle, PCB Mount</b>								
	Solder	.031" Dia. Contact, .157" Leg Length, Thru Hole, J01 Mounting Hole	PE4835	\$16.16	\$15.03	\$13.90	\$12.93	36
<b>Receptacle Straight, PCB Mount</b>								
	Solder	.031" Dia. Contact, .170" Leg Length, Thru Hole, J01 Mounting Hole	PE4832	\$11.60	\$10.79	\$9.98	\$9.28	37
<b>Receptacle Right Angle, PCB Mount</b>								
	Solder	.031" Dia. Contact, .157" Leg Length, Thru Hole, J01 Mounting Hole	PE4834	\$16.16	\$15.03	\$13.90	\$12.93	38

# GR874 Connectors

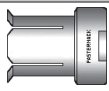
Product Image	Attachment Cable/Contact	Coax Type / Termination Type	Model No.	Price				Row
				1-24	25-49	50-99	100 +	
<b>Sexless Straight, Cable Connectors</b>								
	Crimp/Solder	RG214, RG9, RG225, RG393	PE4352	\$69.06	\$64.23	\$59.39	\$55.25	1
		RG55, RG58, RG141, RG142, RG223, RG400	PE4233	\$69.06	\$64.23	\$59.39	\$55.25	2
<b>Sexless Straight</b>								
	Accessories	GR874 Rebuild Kit which includes Body, Contact, Insulator & Retaining Nut	PE4348	\$35.11	\$32.65	\$30.19	\$28.09	3

# BNC Connectors

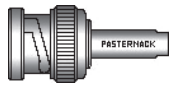
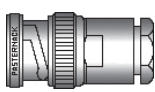
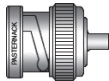
Product Image	Attachment Cable/Contact	Coax Type / Termination Type	Model No.	Price				Row
				1-24	25-49	50-99	100 +	
<b>Male Straight, Cable Connectors</b>								
	Crimp/Solder	RG8X, PE-C240, B7808A	PE44640	\$10.74	\$9.99	\$9.24	\$8.59	4
		RG188-DS, RG316-DS	PE4385	\$10.60	\$9.86	\$9.12	\$8.48	5
		PE-B400, PE-C400	PE44294	\$22.34	\$20.78	\$19.21	\$17.87	6
		PE-C200	PE44041	\$11.90	\$11.07	\$10.23	\$9.52	7
		PE-B150, RG180, RG195	PE4247	\$9.58	\$8.91	\$8.24	\$7.66	8
		PE-B305	PE4210	\$10.34	\$9.62	\$8.89	\$8.27	9
		735A	PE44686	\$21.79	\$20.26	\$18.74	\$17.43	10
		RG174, RG316, RG188	PE4043	\$7.60	\$7.07	\$6.54	\$6.08	11
		RG178, RG196	PE4643	\$17.18	\$15.98	\$14.77	\$13.74	12
		RG213, RG8	PE4378	\$18.20	\$16.93	\$15.65	\$14.56	13
		RG214, RG9, RG225, RG393	PE4351	\$16.21	\$15.08	\$13.94	\$12.97	14
		RG58	PE4016	\$5.35	\$4.98	\$4.60	\$4.28	15
		RG59, RG62	PE4018	\$5.19	\$4.83	\$4.46	\$4.15	16
		RG58 Plenum	PE4381	\$11.91	\$11.08	\$10.24	\$9.53	17
		RG59 Plenum	PE4382	\$12.41	\$11.54	\$10.67	\$9.93	18
RG55, RG141, RG142, RG223, RG400	PE4044	\$4.97	\$4.62	\$4.27	\$3.98	19		
	Clamp/Solder	RG8X, PE-C240	PE4379	\$12.97	\$12.06	\$11.15	\$10.38	20
		PE-B400, PE-B405, PE-C400	PE4386	\$19.96	\$18.56	\$17.17	\$15.97	21
		PE-C200	PE44040	\$11.90	\$11.07	\$10.23	\$9.52	22
		PE-C300	PE44042	\$11.90	\$11.07	\$10.23	\$9.52	23
		PE-B150, RG180, RG195	PE4383	\$26.19	\$24.36	\$22.52	\$20.95	24
		PE-SR401AL, PE-SR401FL, RG401, .250" Semi-Rigid	PE4380	\$18.80	\$17.48	\$16.17	\$15.04	25
		PE-SR402AL, PE-SR402FL, RG402, .141" Semi-Rigid	PE4206	\$15.35	\$14.28	\$13.20	\$12.28	26
		PE-SR405AL, PE-SR405FL, RG405, .085" Semi-Rigid	PE4207	\$17.65	\$16.41	\$15.18	\$14.12	27
		RG174, RG316, RG188	PE4084	\$9.28	\$8.63	\$7.98	\$7.42	28
		RG178, RG196	PE4384	\$12.95	\$12.04	\$11.14	\$10.36	29
		RG213, RG214, RG8, RG9, RG225, RG393, RG11	PE4109	\$11.70	\$10.88	\$10.06	\$9.36	30
		RG58, RG55, RG141, RG142, RG400, RG223	PE4023	\$5.25	\$4.88	\$4.52	\$4.20	31
		RG59, RG62	PE4024	\$6.50	\$6.05	\$5.59	\$5.20	32
		RG6	PE4377	\$11.60	\$10.79	\$9.98	\$9.28	33
			Solder/Solder	PE-047SR, PE-SR047AL, PE-SR047FL, .047" Semi-Rigid	PE4974	\$23.66	\$22.00	\$20.35
PE-SR401AL, PE-SR401FL, RG401, .250" Semi-Rigid	PE4908			\$36.33	\$33.79	\$31.24	\$29.06	35
PE-SR402AL, PE-SR402FL, RG402, .141" Semi-Rigid	PE4650			\$18.39	\$17.10	\$15.82	\$14.71	36
PE-SR405AL, PE-SR405FL, RG405, .085" Semi-Rigid	PE4651			\$18.39	\$17.10	\$15.82	\$14.71	37

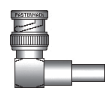
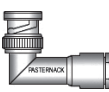
<b>Male Right Angle, Cable Connectors</b>								
	Crimp/Solder	RG8X, PE-C240	PE44641	\$19.25	\$17.90	\$16.56	\$15.40	38
		RG188-DS, RG316-DS	PE4396	\$21.60	\$20.09	\$18.58	\$17.28	39
		RG174, RG316, RG188	PE4393	\$18.64	\$17.34	\$16.03	\$14.91	40
		RG58	PE4298	\$16.42	\$15.27	\$14.12	\$13.14	41
		RG59, RG62	PE4195	\$18.25	\$16.97	\$15.70	\$14.60	42
	Clamp/Solder	RG55, RG141, RG142, RG223, RG400	PE4345	\$15.60	\$14.51	\$13.42	\$12.48	43
		RG174, RG316, RG188	PE4307	\$20.47	\$19.04	\$17.60	\$16.38	44
		RG178, RG196	PE4388	\$17.95	\$16.69	\$15.44	\$14.36	45
		RG213, RG214, RG8, RG9, RG11, RG225, RG393	PE4387	\$25.84	\$24.03	\$22.22	\$20.67	46
		RG59, RG62	PE4320	\$19.91	\$18.52	\$17.12	\$15.93	47
		RG55, RG58, RG141, RG142, RG223, RG400,	PE4053	\$13.43	\$12.49	\$11.55	\$10.74	48

Connectors

See Our Website For Real-Time Stock Availability!

Free Freight Available via UPS Ground to USA & Canada



Real-Time Stock Levels & Pricing On Our Website



Toll-Free Technical Support (866) 727-8376







Same-Day Shipping, Even Custom Cable Assemblies





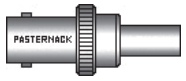

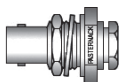

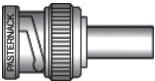
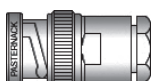

# BNC Connectors

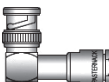
Connectors

See Our Website For Real-Time Stock Availability!

Product Image	Attachment Cable/Contact	Coax Type / Termination Type	Model No.	Price				Row		
				1-24	25-49	50-99	100 +			
	Solder/Solder	PE-SR402AL, PE-SR402FL, RG402, .141" Semi-Rigid	PE4092	\$25.84	\$24.03	\$22.22	\$20.67	1		
		PE-SR405AL, PE-SR405FL, RG405, .085" Semi-Rigid	PE4102	\$31.11	\$28.93	\$26.75	\$24.89	2		
<b>Female Straight, Cable Connectors</b>										
	Crimp/Solder	RG8X, PE-C240	PE44676	\$7.60	\$7.07	\$6.54	\$6.08	3		
		RG188-DS, RG316-DS	PE4390	\$11.90	\$11.07	\$10.23	\$9.52	4		
		735A	PE44688	\$21.79	\$20.26	\$18.74	\$17.43	5		
		RG174, RG316, RG188	PE4079	\$11.10	\$10.32	\$9.55	\$8.88	6		
		RG58	PE4070	\$6.66	\$6.19	\$5.73	\$5.33	7		
		RG59, RG62	PE4308	\$9.58	\$8.91	\$8.24	\$7.66	8		
		RG55, RG141, RG142, RG223, RG400	PE4397	\$7.90	\$7.35	\$6.79	\$6.32	9		
		PE-SR401AL, PE-SR401FL, RG401, .250" Semi-Rigid	PE44674	\$26.75	\$24.88	\$23.01	\$21.40	10		
		PE-SR402AL, PE-SR402FL, RG402, .141" Semi-Rigid	PE4204	\$21.60	\$20.09	\$18.58	\$17.28	11		
	Clamp/Solder	PE-SR405AL, PE-SR405FL, RG405, .085" Semi-Rigid	PE4205	\$21.60	\$20.09	\$18.58	\$17.28	12		
		RG174, RG316, RG188	PE4321	\$10.60	\$9.86	\$9.12	\$8.48	13		
		RG178, RG196	PE4389	\$14.35	\$13.35	\$12.34	\$11.48	14		
		RG213, RG214, RG8, RG9, RG11, RG225, RG393	PE4212	\$31.92	\$29.69	\$27.45	\$25.54	15		
		RG58, RG55, RG141, RG142, RG400, RG223	PE4058	\$6.98	\$6.49	\$6.00	\$5.58	16		
		RG59, RG62	PE4057	\$6.29	\$5.85	\$5.41	\$5.03	17		
		<b>Female Straight, Bulkhead Mount, Cable Connectors</b>								
			Crimp/Solder	RG188-DS, RG316-DS, B06 Mounting Hole	PE4392	\$14.35	\$13.35	\$12.34	\$11.48	18
				735A, B06 Mounting Hole	PE44687	\$21.79	\$20.26	\$18.74	\$17.43	19
RG174, RG316, RG188, B06 Mounting Hole	PE4106			\$11.96	\$11.12	\$10.29	\$9.57	20		
RG178, RG196, w/o-ring, B06 Mounting Hole	PE44658			\$12.87	\$11.97	\$11.07	\$10.30	21		
RG58, B06 Mounting Hole	PE4208			\$10.20	\$9.49	\$8.77	\$8.16	22		
RG59, RG62, B06 Mounting Hole	PE4309			\$13.22	\$12.29	\$11.37	\$10.58	23		
RG55, RG141, RG142, RG223, RG400, B06 Mounting Hole	PE4209			\$14.14	\$13.15	\$12.16	\$11.31	24		
PE-SR402AL, PE-SR402FL, RG402, B06 Mounting Hole, .141" Semi-Rigid	PE4915			\$25.20	\$23.44	\$21.67	\$20.16	25		
PE-SR405AL, PE-SR405FL, RG405, B06 Mounting Hole, .085" Semi-Rigid	PE4916			\$25.20	\$23.44	\$21.67	\$20.16	26		
	Clamp/Solder	RG174, RG316, RG188, B06 Mounting Hole	PE4319	\$12.95	\$12.04	\$11.14	\$10.36	27		
		RG178, RG196, B06 Mounting Hole	PE4391	\$15.60	\$14.51	\$13.42	\$12.48	28		
		RG213, RG214, RG8, RG9, RG11, RG225, RG393, B06 Mounting Hole	PE4632	\$35.11	\$32.65	\$30.19	\$28.09	29		
		RG58, RG55, RG141, RG142, RG400, RG223, B06 Mounting Hole	PE4078	\$12.48	\$11.61	\$10.73	\$9.98	30		
		RG59, RG62, B06 Mounting Hole	PE4310	\$23.66	\$22.00	\$20.35	\$18.93	31		
		<b>Female Straight, Panel Mount, Cable Connectors</b>								
			Clamp/Solder	4 Hole Flange, RG58, RG55, RG141, RG142, RG223, RG400, A03 Mounting Hole	PE4056	\$12.21	\$11.36	\$10.50	\$9.77	32
		<b>Reverse Polarity Male Straight, Cable Connectors</b>								
			Crimp/Solder	RG174, RG316, RG188	PE4720	\$18.59	\$17.29	\$15.99	\$14.87	33
RG213, RG8	PE4712			\$22.75	\$21.16	\$19.57	\$18.20	34		
RG214, RG9, RG393	PE4713			\$24.88	\$23.14	\$21.40	\$19.90	35		
RG58	PE4716			\$12.12	\$11.27	\$10.42	\$9.70	36		
RG59, RG62	PE4718			\$12.41	\$11.54	\$10.67	\$9.93	37		
RG55, RG141, RG142, RG223, RG400	PE4715			\$11.35	\$10.56	\$9.76	\$9.08	38		
PE-B400, PE-B405	PE4726			\$24.88	\$23.14	\$21.40	\$19.90	39		
PE-SR402AL, PE-SR402FL, RG402, .141" Semi-Rigid	PE4722			\$18.95	\$17.62	\$16.30	\$15.16	40		
PE-SR405AL, PE-SR405FL, RG405, .085" Semi-Rigid	PE4724			\$18.95	\$17.62	\$16.30	\$15.16	41		
	Clamp/Solder	RG174, RG316, RG188	PE4719	\$24.88	\$23.14	\$21.40	\$19.90	42		
		RG178, RG196	PE4721	\$22.30	\$20.74	\$19.18	\$17.84	43		
		RG213, RG214, RG8, RG9, RG225, RG393	PE4711	\$24.88	\$23.14	\$21.40	\$19.90	44		
		RG58, RG55, RG141, RG142, RG400, RG223	PE4714	\$24.88	\$23.14	\$21.40	\$19.90	45		
		RG59, RG62	PE4717	\$24.88	\$23.14	\$21.40	\$19.90	46		
		PE-SR402AL, PE-SR402FL, RG402, .141" Semi-Rigid	PE4723	\$24.88	\$23.14	\$21.40	\$19.90	47		
		PE-SR405AL, PE-SR405FL, RG405, .085" Semi-Rigid	PE4725	\$22.30	\$20.74	\$19.18	\$17.84	48		

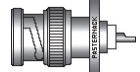
# BNC Connectors

Product Image	Attachment Cable/Contact	Coax Type / Termination Type	Model No.	Price				Row
				1-24	25-49	50-99	100 +	
<b>Reverse Polarity Male Right Angle, Cable Connectors</b>								
	Crimp/Solder	RG174, RG316, RG188	<b>PE4733</b>	\$18.59	\$17.29	\$15.99	\$14.87	1
		RG58	<b>PE4730</b>	\$21.13	\$19.65	\$18.17	\$16.90	2
		RG55, RG141, RG142, RG223, RG400	<b>PE4729</b>	\$18.95	\$17.62	\$16.30	\$15.16	3
	Clamp/Solder	RG174, RG316, RG188	<b>PE4732</b>	\$22.30	\$20.74	\$19.18	\$17.84	4
		RG178, RG196	<b>PE4734</b>	\$22.30	\$20.74	\$19.18	\$17.84	5
		RG213, RG214, RG8, RG9, RG225, RG393	<b>PE4727</b>	\$31.11	\$28.93	\$26.75	\$24.89	6
		RG59, RG62	<b>PE4731</b>	\$24.88	\$23.14	\$21.40	\$19.90	7
		RG55, RG58, RG141, RG142, RG400, RG223	<b>PE4728</b>	\$24.88	\$23.14	\$21.40	\$19.90	8
<b>Reverse Polarity Female Straight, Cable Connectors</b>								
	Crimp/Solder	RG174, RG316, RG188	<b>PE4742</b>	\$18.59	\$17.29	\$15.99	\$14.87	9
		RG58	<b>PE4738</b>	\$18.59	\$17.29	\$15.99	\$14.87	10
		RG59, RG62	<b>PE4739</b>	\$18.59	\$17.29	\$15.99	\$14.87	11
		RG55, RG141, RG142, RG223, RG400	<b>PE4737</b>	\$17.00	\$15.81	\$14.62	\$13.60	12
	Clamp/Solder	PE-SR402AL, PE-SR402FL, RG402, .141" Semi-Rigid	<b>PE4744</b>	\$19.30	\$17.95	\$16.60	\$15.44	13
		PE-SR405AL, PE-SR405FL, RG405, .085" Semi-Rigid	<b>PE4745</b>	\$18.95	\$17.62	\$16.30	\$15.16	14
		RG174, RG316, RG188	<b>PE4741</b>	\$22.30	\$20.74	\$19.18	\$17.84	15
		RG178, RG196	<b>PE4743</b>	\$22.30	\$20.74	\$19.18	\$17.84	16
		RG213, RG214, RG8, RG9, RG393, RG225	<b>PE4735</b>	\$29.94	\$27.84	\$25.75	\$23.95	17
		RG59, RG62	<b>PE4740</b>	\$24.88	\$23.14	\$21.40	\$19.90	18
		RG55, RG58, RG141, RG142, RG400, RG223	<b>PE4736</b>	\$24.88	\$23.14	\$21.40	\$19.90	19
<b>Reverse Polarity Female Straight, Bulkhead Mount, Cable Connectors</b>								
	Crimp/Solder	RG174, RG316, RG188, B06 Mounting Hole	<b>PE4752</b>	\$21.13	\$19.65	\$18.17	\$16.90	20
		RG58, B06 Mounting Hole	<b>PE4748</b>	\$21.13	\$19.65	\$18.17	\$16.90	21
		RG59, RG62, B06 Mounting Hole	<b>PE4750</b>	\$21.13	\$19.65	\$18.17	\$16.90	22
		RG55, RG141, RG142, RG223, RG400, B06 Mounting Hole	<b>PE4747</b>	\$19.30	\$17.95	\$16.60	\$15.44	23
	Clamp/Solder	PE-SR402AL, PE-SR402FL, RG402, B06 Mounting Hole, .141" Semi-Rigid	<b>PE4754</b>	\$22.30	\$20.74	\$19.18	\$17.84	24
		PE-SR405AL, PE-SR405FL, RG405, B06 Mounting Hole, .085" Semi-Rigid	<b>PE4755</b>	\$22.30	\$20.74	\$19.18	\$17.84	25
		RG174, RG316, RG188, B06 Mounting Hole	<b>PE4751</b>	\$18.60	\$17.30	\$16.00	\$14.88	26
		RG178, RG196, B06 Mounting Hole	<b>PE4753</b>	\$18.60	\$17.30	\$16.00	\$14.88	27
		RG59, RG62, B06 Mounting Hole	<b>PE4749</b>	\$21.13	\$19.65	\$18.17	\$16.90	28
RG55, RG58, RG141, RG142, RG400, RG223, B06 Mounting Hole	<b>PE4746</b>	\$18.24	\$16.96	\$15.69	\$14.59	29		
<b>Reverse Polarity Female Straight, Panel Mount, Cable Connectors</b>								
	Clamp/Solder	4 Hole Flange, RG55, RG58, RG141, RG142, RG223, RG400, A03 Mounting Hole	<b>PE4765</b>	\$24.88	\$23.14	\$21.40	\$19.90	30
<b>Male Straight, Bulkhead Mount, Terminal</b>								
	Solder	Solder Cup Contact, .220" Max Panel, B04 Mounting Hole	<b>PE4211</b>	\$11.10	\$10.32	\$9.55	\$8.88	31
<b>Male Straight, Panel Mount, Terminal</b>								
	Solder	4 Hole Flange, Solder Cup Contact, A07 Mounting Hole	<b>PE4082</b>	\$12.06	\$11.22	\$10.37	\$9.65	32
<b>Female Straight, Bulkhead Mount, Terminal</b>								
	Solder	Solder Cup Contact, .250" Max Panel, B04 Mounting Hole	<b>PE4015</b>	\$5.02	\$4.67	\$4.32	\$4.02	33
		Solder Cup Contact, .125" Max Panel, B05 Mounting Hole	<b>PE4014</b>	\$4.91	\$4.57	\$4.22	\$3.93	34
		Wire Terminal, Hermetically Sealed, Front Mount, .250" Max Panel, B04 Mounting Hole	<b>PE4077</b>	\$12.90	\$12.00	\$11.09	\$10.32	35
		Wire Terminal, Hermetically Sealed, Rear Mount, .250" Max Panel, B06 Mounting Hole	<b>PE4049</b>	\$12.64	\$11.76	\$10.87	\$10.11	36
		Solder Cup Contact, Isolated Ground, .125" Max Panel, B04 Mounting Hole	<b>PE4091</b>	\$7.09	\$6.59	\$6.10	\$5.67	37
		Solder Cup Contact, Isolated Ground, .187" Max Panel, B06 Mounting Hole	<b>PE4318</b>	\$12.31	\$11.45	\$10.59	\$9.85	38

Connectors

See Our Website For Real-Time Stock Availability!

 Free Freight Available via UPS Ground to USA & Canada

 Real-Time Stock Levels & Pricing On Our WebSite







 Toll-Free Technical Support (866) 727-8376

 Same-Day Shipping, Even Custom Cable Assemblies

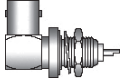

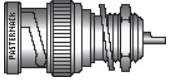

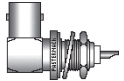
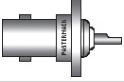

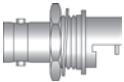
# BNC Connectors

Connectors

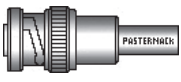
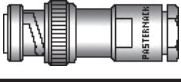
See Our Website For Real-Time Stock Availability!

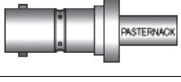
Product Image	Attachment Cable/Contact	Coax Type / Termination Type	Model No.	Price				Row
				1-24	25-49	50-99	100 +	
<b>Female Right Angle, Bulkhead Mount, Terminal</b>								
	Solder	Solder Cup Contact, .300" Max Panel, B13 Mounting Hole	PE4055	\$19.04	\$17.71	\$16.37	\$15.23	1
<b>Female Straight, Panel Mount, Terminal</b>								
	Solder	4 Hole Flange, Solder Cup Contact, A03 Mounting Hole	PE4010	\$6.29	\$5.85	\$5.41	\$5.03	2
		4 Hole Flange, Solder Cup Contact, 1.00" Flange Size, A05 Mounting Hole	PE4395	\$16.16	\$15.03	\$13.90	\$12.93	3
		4 Hole Flange, Solder Cup Contact, .687" Flange Size, A04 Mounting Hole	PE4394	\$9.02	\$8.39	\$7.76	\$7.22	4
		4 Hole Flange, Turret, A16 Mounting Hole	PE4011	\$14.24	\$13.24	\$12.25	\$11.39	5
<b>Female Right Angle, Panel Mount, Terminal</b>								
	Solder	4 Hole Flange, Solder Cup Contact, A16 Mounting Hole	PE4317	\$18.39	\$17.10	\$15.82	\$14.71	6
<b>Reverse Polarity Male Straight, Bulkhead Mount, Terminal</b>								
	Solder	Solder Cup Contact, .225" Max Panel, B04 Mounting Hole	PE4761	\$18.59	\$17.29	\$15.99	\$14.87	7
<b>Reverse Polarity Male Straight, Panel Mount, Terminal</b>								
	Solder	4 Hole Flange, Solder Cup Contact, A07 Mounting Hole	PE4762	\$18.59	\$17.29	\$15.99	\$14.87	8
<b>Reverse Polarity Female Straight, Bulkhead Mount, Terminal</b>								
	Solder	Solder Cup Contact, .250" Max Panel, B04 Mounting Hole	PE4758	\$11.60	\$10.79	\$9.98	\$9.28	9
		Solder Cup Contact, .125" Max Panel, B05 Mounting Hole	PE4757	\$11.60	\$10.79	\$9.98	\$9.28	10
		Solder Cup Contact, Isolated Ground, .180" Max Panel, B06 Mounting Hole	PE4764	\$15.60	\$14.51	\$13.42	\$12.48	11
<b>Reverse Polarity Female Right Angle, Bulkhead Mount, Terminal</b>								
	Solder	Solder Cup Contact, .300" Max Panel, B13 Mounting Hole	PE4759	\$37.34	\$34.73	\$32.11	\$29.87	12
<b>Reverse Polarity Female Straight, Panel Mount, Terminal</b>								
	Solder	4 Hole Flange, Solder Cup Contact, A04 Mounting Hole	PE4763	\$18.59	\$17.29	\$15.99	\$14.87	13
		4 Hole Flange, Solder Cup Contact, A03 Mounting Hole	PE4756	\$18.59	\$17.29	\$15.99	\$14.87	14
<b>Reverse Polarity Female Right Angle, Panel Mount, Terminal</b>								
	Solder	4 Hole Flange, Solder Cup Contact, A16 Mounting Hole	PE4760	\$37.34	\$34.73	\$32.11	\$29.87	15
<b>Female Straight, PCB Mount</b>								
	Solder	Surface Mount, Edge Launch Grip	PE44616	\$9.63	\$8.96	\$8.28	\$7.70	16
<b>Female Straight, Bulkhead Mount, PCB Mount</b>								
	Solder	Surface Mount, Edge Launch, .110" Max Panel, F02 Mounting Hole	PE44618	\$13.07	\$12.16	\$11.24	\$10.46	17

# MHV Connectors

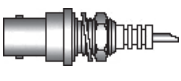
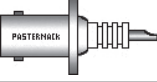
Product Image	Attachment Cable/Contact	Coax Type / Termination Type	Model No.	Price				Row		
				1-24	25-49	50-99	100 +			
<b>Male Straight, Cable Connectors</b>										
	Crimp/Solder	RG174, RG316, RG188	PE4933	\$29.39	\$27.33	\$25.28	\$23.51	1		
		RG213, RG8	PE4493	\$24.00	\$22.32	\$20.64	\$19.20	2		
		RG214, RG9, RG393	PE4350	\$24.57	\$22.85	\$21.13	\$19.66	3		
		RG58	PE4093	\$20.04	\$18.64	\$17.23	\$16.03	4		
		RG59, RG62	PE4075	\$11.55	\$10.74	\$9.93	\$9.24	5		
		RG55, RG141, RG142, RG223, RG400	PE4657	\$14.75	\$13.72	\$12.69	\$11.80	6		
	Clamp/Solder	RG174, RG316, RG188	PE4494	\$12.95	\$12.04	\$11.14	\$10.36	7		
		RG213, RG214, RG8, RG9, RG11, RG225, RG393	PE4299	\$23.51	\$21.86	\$20.22	\$18.81	8		
		RG58, RG55, RG141, RG142, RG400, RG223	PE4076	\$10.99	\$10.22	\$9.45	\$8.79	9		
		RG59, RG62	PE4098	\$11.30	\$10.51	\$9.72	\$9.04	10		
		<b>Male Right Angle, Cable Connectors</b>								
			Clamp/Solder	RG174, RG316, RG188	PE4710	\$25.20	\$23.44	\$21.67	\$20.16	11
RG213, RG214, RG8, RG9, RG11, RG225, RG393	PE4709			\$45.40	\$42.22	\$39.04	\$36.32	12		
RG58, RG55, RG141, RG142, RG400, RG223	PE4226			\$25.13	\$23.37	\$21.61	\$20.10	13		
RG59, RG62	PE4227			\$24.57	\$22.85	\$21.13	\$19.66	14		
<b>Female Straight, Cable Connectors</b>										
	Crimp/Solder	RG58	PE44102	\$21.13	\$19.65	\$18.17	\$16.90	15		
		RG59, RG62	PE44103	\$24.88	\$23.14	\$21.40	\$19.90	16		
		RG55, RG141, RG142, RG223, RG400	PE44100	\$22.75	\$21.16	\$19.57	\$18.20	17		
	Clamp/Solder	RG174, RG316, RG188	PE44104	\$21.60	\$20.09	\$18.58	\$17.28	18		
		RG213, RG214, RG8, RG9, RG11, RG225, RG393	PE4373	\$33.64	\$31.29	\$28.93	\$26.91	19		
		RG59, RG62	PE4181	\$17.18	\$15.98	\$14.77	\$13.74	20		
		RG55, RG58, RG141, RG142, RG223, RG400,	PE4225	\$18.24	\$16.96	\$15.69	\$14.59	21		
<b>Female Straight, Bulkhead Mount, Cable Connectors</b>										
	Crimp/Solder	RG58, B06 Mounting Hole	PE44108	\$27.31	\$25.40	\$23.49	\$21.85	22		
		RG59, RG62, B06 Mounting Hole	PE44110	\$32.37	\$30.10	\$27.84	\$25.90	23		
		RG55, RG141, RG142, RG223, RG400, B06 Mounting Hole	PE44107	\$25.70	\$23.90	\$22.10	\$20.56	24		
	Clamp/Solder	RG174, RG316, RG188, B06 Mounting Hole	PE44111	\$34.15	\$31.76	\$29.37	\$27.32	25		
		RG213, RG214, RG8, RG9, RG11, RG225, RG393, B06 Mounting Hole	PE44105	\$45.45	\$42.27	\$39.09	\$36.36	26		
		RG59, RG62, B06 Mounting Hole	PE44109	\$31.11	\$28.93	\$26.75	\$24.89	27		
		RG55, RG58, RG141, RG142, RG223, RG400, B06 Mounting Hole	PE44106	\$31.11	\$28.93	\$26.75	\$24.89	28		
<b>Female Straight, Panel Mount, Cable Connectors</b>										
	Clamp/Solder	4 Hole Flange, RG174, RG316, RG188, A03 Mounting Hole	PE44113	\$31.30	\$29.11	\$26.92	\$25.04	29		
		4 Hole Flange, RG213, RG214, RG8, RG9, RG11, RG225, RG393, A05 Mounting Hole	PE44112	\$37.34	\$34.73	\$32.11	\$29.87	30		
		4 Hole Flange, RG59, RG62, A03 Mounting Hole	PE4314	\$34.86	\$32.42	\$29.98	\$27.89	31		
		4 Hole Flange, RG55, RG58, RG141, RG142, RG223, RG400, A03 Mounting Hole	PE4313	\$34.86	\$32.42	\$29.98	\$27.89	32		
<b>Female Straight, Bulkhead Mount, Terminal</b>										
	Solder	Solder Cup Contact, Front Mount, w/o-ring, .218" Max Panel, G02 Mounting Hole	PE4193	\$15.30	\$14.23	\$13.16	\$12.24	33		
		Turret, Rear Mount, .125" Max Panel, B08 Mounting Hole	PE4312	\$27.36	\$25.44	\$23.53	\$21.89	34		
		Solder Cup Contact, Hermetically Sealed, Front Mount, .250" Max Panel, G02 Mounting Hole	PE4311	\$35.36	\$32.88	\$30.41	\$28.29	35		
		Solder Cup Contact, Hermetically Sealed, Rear Mount, .250" Max Panel, B06 Mounting Hole	PE4495	\$34.00	\$31.62	\$29.24	\$27.20	36		
<b>Female Straight, Panel Mount, Terminal</b>										
	Solder	4 Hole Flange, Solder Cup Contact, A03 Mounting Hole	PE4228	\$21.68	\$20.16	\$18.64	\$17.34	37		

Connectors

See Our Website For Real-Time Stock Availability!

The N connector was one of the first connectors capable of carrying microwave-frequency signals.

# SHV Connectors

Connectors

Product Image	Attachment Cable/Contact	Coax Type / Termination Type	Model No.	Price				Row
				1-24	25-49	50-99	100 +	
<b>Plug Straight, Cable Connectors</b>								
	Crimp/Solder	RG213, RG8	PE4496	\$26.45	\$24.60	\$22.75	\$21.16	1
		RG214, RG9, RG225, RG393	PE4349	\$27.11	\$25.21	\$23.31	\$21.69	2
		RG58	PE4194	\$28.53	\$26.53	\$24.54	\$22.82	3
		RG59, RG62	PE4343	\$28.53	\$26.53	\$24.54	\$22.82	4
		RG55, RG141, RG142, RG223, RG400	PE4497	\$26.45	\$24.60	\$22.75	\$21.16	5
	Clamp/Solder	RG174, RG316, RG188	PE4498	\$26.80	\$24.92	\$23.05	\$21.44	6
		RG213, RG214, RG8, RG9, RG225, RG393	PE4333	\$27.06	\$25.17	\$23.27	\$21.65	7
		RG58, RG55, RG141, RG142, RG400, RG223	PE4316	\$18.39	\$17.10	\$15.82	\$14.71	8
		RG59, RG62	PE4100	\$18.44	\$17.15	\$15.86	\$14.75	9
<b>Jack Straight, Bulkhead Mount, Cable Connectors</b>								
	Clamp/Solder	RG174, RG316, RG188, B06 Mounting Hole	PE44093	\$34.80	\$32.36	\$29.93	\$27.84	10
		RG213, RG214, RG8, RG9, RG225, RG393, B06 Mounting Hole	PE44049	\$44.59	\$41.47	\$38.35	\$35.67	11
		RG58, RG55, RG141, RG142, RG400, RG223, B06 Mounting Hole	PE44080	\$34.35	\$31.95	\$29.54	\$27.48	12
		RG59, RG62, B06 Mounting Hole	PE4315	\$34.35	\$31.95	\$29.54	\$27.48	13
<b>Plug Straight, Bulkhead Mount, Terminal</b>								
	Solder	Solder Cup Contact, Front Mount, .218" Max Panel, B04 Mounting Hole	PE44118	\$35.26	\$32.79	\$30.32	\$28.21	14
<b>Jack Straight, Bulkhead Mount, Terminal</b>								
	Solder	Solder Cup Contact, Front Mount, .225" Max Panel, B04 Mounting Hole	PE4239	\$15.94	\$14.82	\$13.71	\$12.75	15
		Solder Cup Contact, Rear Mount, .250" Max Panel, B06 Mounting Hole	PE4499	\$19.98	\$18.58	\$17.18	\$15.98	16
		Solder Cup Contact, Hermetically Sealed, Front Mount, .250" Max Panel, B04 Mounting Hole	PE4500	\$47.12	\$43.82	\$40.52	\$37.70	17
<b>Jack Straight, Panel Mount, Terminal</b>								
	Solder	4 Hole Flange, Solder Cup Contact, A15 Mounting Hole	PE4501	\$22.87	\$21.27	\$19.67	\$18.30	18







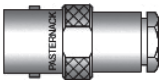

# C Connectors

See Our Website For Real-Time Stock Availability!

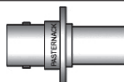
Product Image	Attachment Cable/Contact	Coax Type / Termination Type	Model No.	Price				Row
				1-24	25-49	50-99	100 +	
<b>Male Straight, Cable Connectors</b>								
	Crimp/Solder	RG213, RG8	PE4518	\$26.20	\$24.37	\$22.53	\$20.96	19
		RG214, RG9, RG225, RG393	PE4375	\$21.13	\$19.65	\$18.17	\$16.90	20
		RG58	PE4517	\$26.15	\$24.32	\$22.49	\$20.92	21
		RG55, RG141, RG142, RG223, RG400	PE4445	\$20.42	\$18.99	\$17.56	\$16.34	22
		RG14, RG217	PE4951	\$43.52	\$40.47	\$37.43	\$34.82	23
	Clamp/Solder	RG174, RG316, RG188	PE4953	\$24.50	\$22.79	\$21.07	\$19.60	24
		RG213, RG214, RG8, RG9, RG11, RG225, RG393, High Voltage	PE4950	\$42.06	\$39.12	\$36.17	\$33.65	25
		RG213, RG214, RG8, RG9, RG11, RG225, RG393	PE4243	\$30.42	\$28.29	\$26.16	\$24.34	26
		RG218	PE4954	\$74.83	\$69.59	\$64.35	\$59.86	27
		RG58, RG55, RG141, RG142, RG400, RG223	PE4242	\$34.60	\$32.18	\$29.76	\$27.68	28
		RG59, RG62	PE4952	\$31.11	\$28.93	\$26.75	\$24.89	29
<b>Male Right Angle, Cable Connectors</b>								
	Crimp/Solder	RG213, RG8	PE4955	\$51.20	\$47.62	\$44.03	\$40.96	30
		RG214, RG9, RG225, RG393	PE4949	\$58.92	\$54.80	\$50.67	\$47.14	31
		RG58	PE4959	\$61.10	\$56.82	\$52.55	\$48.88	32
		RG55, RG141, RG142, RG223, RG400	PE4958	\$51.20	\$47.62	\$44.03	\$40.96	33
	Clamp/Solder	RG213, RG214, RG8, RG9, RG11, RG225, RG393	PE4244	\$52.74	\$49.05	\$45.36	\$42.19	34
		RG58, RG55, RG141, RG142, RG400, RG223	PE4957	\$61.10	\$56.82	\$52.55	\$48.88	35

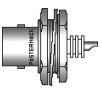

# C Connectors

Product Image	Attachment Cable/Contact	Coax Type / Termination Type	Model No.	Price				Row
				1-24	25-49	50-99	100 +	
<b>Female Straight, Cable Connectors</b>								
	Clamp/Solder	RG14, RG217	PE4963	\$56.04	\$52.12	\$48.19	\$44.83	1
		RG213, RG214, RG8, RG9, RG11, RG225, RG393	PE4960	\$43.52	\$40.47	\$37.43	\$34.82	2
		RG58, RG55, RG141, RG142, RG400, RG223	PE4961	\$56.04	\$52.12	\$48.19	\$44.83	3
		RG59, RG62	PE4962	\$39.06	\$36.33	\$33.59	\$31.25	4
<b>Female Straight, Bulkhead Mount, Cable Connectors</b>								
	Clamp/Solder	RG213, RG214, RG8, RG9, RG11, RG225, RG393, Rear Mount, B07 Mounting Hole	PE4964	\$47.37	\$44.05	\$40.74	\$37.90	5
		RG58, RG55, RG141, RG142, RG400, RG223, Front Mount, B15 Mounting Hole	PE44099	\$49.91	\$46.42	\$42.92	\$39.93	6
		RG58, RG55, RG141, RG142, RG400, RG223, Rear Mount, B07 Mounting Hole	PE4965	\$56.04	\$52.12	\$48.19	\$44.83	7
		RG59, RG62, Front Mount, B15 Mounting Hole	PE44098	\$49.91	\$46.42	\$42.92	\$39.93	8
		RG59, RG62, Rear Mount, B07 Mounting Hole	PE4966	\$56.04	\$52.12	\$48.19	\$44.83	9
<b>Female Straight, Panel Mount, Cable Connectors</b>								
	Crimp/Solder	4 Hole Flange, RG213, RG8, A05 Mounting Hole	PE4968	\$39.10	\$36.36	\$33.63	\$31.28	10
		4 Hole Flange, RG214, RG9, RG225, RG393, A05 Mounting Hole	PE4374	\$49.91	\$46.42	\$42.92	\$39.93	11
	Clamp/Solder	4 Hole Flange, RG213, RG214, RG8, RG9, RG11, RG225, RG393, A19 Mounting Hole	PE4967	\$56.04	\$52.12	\$48.19	\$44.83	12
		4 Hole Flange, RG58, RG55, RG141, RG142, RG400, RG223, A19 Mounting Hole	PE4969	\$41.14	\$38.26	\$35.38	\$32.91	13
		4 Hole Flange, RG59, RG62, A19 Mounting Hole	PE4970	\$56.04	\$52.12	\$48.19	\$44.83	14
<b>Male Straight, Bulkhead Mount, Terminal</b>								
	Solder	Solder Cup Contact, Front Mount, .125" Max Panel, B04 Mounting Hole	PE44097	\$56.04	\$52.12	\$48.19	\$44.83	15
<b>Male Straight, Panel Mount, Terminal</b>								
	Solder	4 Hole Flange, Solder Cup Contact, A14 Mounting Hole	PE44096	\$44.48	\$41.37	\$38.25	\$35.58	16
<b>Female Straight, Bulkhead Mount, Terminal</b>								
	Solder	Solder Cup Contact, Rear Mount, .135" Max Panel, B07 Mounting Hole	PE4240	\$36.99	\$34.40	\$31.81	\$29.59	17
		Solder Cup Contact, Rear Mount, High Voltage, 3000 Volts, .135" Max Panel, B07 Mounting Hole	PE4972	\$56.04	\$52.12	\$48.19	\$44.83	18
		Turret, Front Mount, .115" Max Panel, B04 Mounting Hole	PE4973	\$56.04	\$52.12	\$48.19	\$44.83	19
		Solder Cup Contact, Hermetically Sealed, Rear Mount, .250" Max Panel, B07 Mounting Hole	PE4971	\$56.04	\$52.12	\$48.19	\$44.83	20
<b>Female Straight, Panel Mount, Terminal</b>								
	Solder	4 Hole Flange, Solder Cup Contact, A14 Mounting Hole	PE4241	\$16.52	\$15.36	\$14.21	\$13.22	21
		4 Hole Flange, Solder Cup Contact, High Voltage, 3000 Volts, A14 Mounting Hole	PE44117	\$25.84	\$24.03	\$22.22	\$20.67	22

Connectors

See Our Website For Real-Time Stock Availability!

# 75 Ohm N Connectors

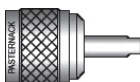
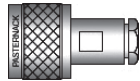
Product Image	Attachment Cable/Contact	Coax Type / Termination Type	Model No.	Price				Row
				1-24	25-49	50-99	100 +	
<b>Male Straight, Cable Connectors</b>								
	Crimp/Solder	RG179, RG187	PE4656	\$18.39	\$17.10	\$15.82	\$14.71	23
		RG59, RG62	PE4512	\$17.18	\$15.98	\$14.77	\$13.74	24
		RG11, RG144, RG216	PE4510	\$17.18	\$15.98	\$14.77	\$13.74	25
		RG6	PE4508	\$17.18	\$15.98	\$14.77	\$13.74	26
	Clamp/Solder	RG179, RG187	PE4513	\$15.35	\$14.28	\$13.20	\$12.28	27
		RG59, RG62	PE4511	\$15.96	\$14.84	\$13.73	\$12.77	28
		RG11, RG144, RG216	PE4509	\$21.13	\$19.65	\$18.17	\$16.90	29
		RG6	PE4507	\$15.96	\$14.84	\$13.73	\$12.77	30

Free Freight Available via UPS Ground to USA & Canada



Real-Time Stock Levels & Pricing On Our WebSite







Toll-Free Technical Support (866) 727-8376







Same-Day Shipping, Even Custom Cable Assemblies

# 75 Ohm N Connectors

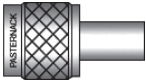
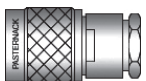
Product Image	Attachment Cable/Contact	Coax Type / Termination Type	Model No.	Price				Row
				1-24	25-49	50-99	100 +	
<b>Male Right Angle, Cable Connectors</b>								
	Clamp/Solder	RG11, RG144, RG216	PE4502	\$37.34	\$34.73	\$32.11	\$29.87	1
<b>Female Straight, Cable Connectors</b>								
	Clamp/Solder	RG59, RG62	PE4516	\$24.88	\$23.14	\$21.40	\$19.90	2
		RG11, RG144, RG216	PE4515	\$24.42	\$22.71	\$21.00	\$19.54	3
		RG6	PE4514	\$21.13	\$19.65	\$18.17	\$16.90	4
<b>Male Straight, Panel Mount, Terminal</b>								
	Solder	4 Hole Flange, Solder Cup Contact, A05 Mounting Hole	PE4504	\$17.18	\$15.98	\$14.77	\$13.74	5
<b>Female Straight, Bulkhead Mount, Terminal</b>								
	Solder	Solder Cup Contact, Front Mount, .260" Max Panel, G01 Mounting Hole	PE4505	\$19.15	\$17.81	\$16.47	\$15.32	6
		Solder Cup Contact, Front Mount, .125" Max Panel, F05 Mounting Hole	PE4506	\$12.21	\$11.36	\$10.50	\$9.77	7
<b>Female Straight, Panel Mount, Terminal</b>								
	Solder	4 Hole Flange, Solder Cup Contact, A05 Mounting Hole	PE4503	\$12.46	\$11.59	\$10.72	\$9.97	8

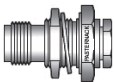

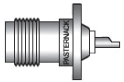







# 75 Ohm TNC Connectors

Product Image	Attachment Cable/Contact	Coax Type / Termination Type	Model No.	Price				Row
				1-24	25-49	50-99	100 +	
<b>Male Straight, Cable Connectors</b>								
	Crimp/Solder	RG179, RG187	PE44168	\$13.65	\$12.69	\$11.74	\$10.92	9
		RG59	PE44166	\$13.65	\$12.69	\$11.74	\$10.92	10
		RG11	PE44164	\$24.88	\$23.14	\$21.40	\$19.90	11
		RG6	PE44162	\$14.08	\$13.09	\$12.11	\$11.26	12
	Clamp/Solder	RG179, RG187	PE44167	\$13.40	\$12.46	\$11.52	\$10.72	13
		RG59	PE44165	\$13.40	\$12.46	\$11.52	\$10.72	14
		RG11, RG216	PE44163	\$38.20	\$35.53	\$32.85	\$30.56	15
		RG6	PE44161	\$17.85	\$16.60	\$15.35	\$14.28	16
<b>Male Right Angle, Cable Connectors</b>								
	Clamp/Solder	RG179, RG187	PE44172	\$37.34	\$34.73	\$32.11	\$29.87	17
		RG59	PE44171	\$37.34	\$34.73	\$32.11	\$29.87	18
		RG11, RG216	PE44170	\$37.34	\$34.73	\$32.11	\$29.87	19
		RG6	PE44169	\$37.34	\$34.73	\$32.11	\$29.87	20
<b>Female Straight, Bulkhead Mount, Cable Connectors</b>								
	Clamp/Solder	RG179, RG187, B06 Mounting Hole	PE44176	\$32.02	\$29.78	\$27.54	\$25.62	21
		RG59, B06 Mounting Hole	PE44175	\$35.26	\$32.79	\$30.32	\$28.21	22
		RG11, RG216, B06 Mounting Hole	PE44174	\$33.79	\$31.42	\$29.06	\$27.03	23
		RG6, B06 Mounting Hole	PE44173	\$31.11	\$28.93	\$26.75	\$24.89	24
<b>Female Straight, Bulkhead Mount, Terminal</b>								
	Solder	Solder Cup Contact, .200" Max Panel, B05 Mounting Hole	PE44177	\$12.97	\$12.06	\$11.15	\$10.38	25
		Solder Cup Contact, .125" Max Panel, B04 Mounting Hole	PE44180	\$16.16	\$15.03	\$13.90	\$12.93	26
		Solder Cup Contact, Isolated Ground, .180" Max Panel, B06 Mounting Hole	PE44181	\$18.59	\$17.29	\$15.99	\$14.87	27
<b>Female Straight, Panel Mount, Terminal</b>								
	Solder	4 Hole Flange, Solder Cup Contact, A03 Mounting Hole	PE44178	\$12.97	\$12.06	\$11.15	\$10.38	28

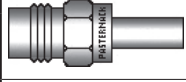
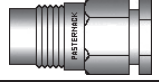
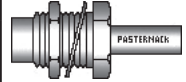
Connectors

See Our Website For Real-Time Stock Availability!



# 75 Ohm SMC Connectors (These Connectors will not mate with any 50 Ohm SMC Connectors)

Product Image	Attachment Cable/Contact	Coax Type / Termination Type	Model No.	Price				Row
				1-24	25-49	50-99	100 +	
<b>Plug Straight, Cable Connectors</b>								
	Crimp/Solder	RG179, RG187	<b>PE4249</b>	\$15.30	\$14.23	\$13.16	\$12.24	1
		RG180, RG195	<b>PE4158</b>	\$16.92	\$15.74	\$14.55	\$13.54	2
		RG59, RG62	<b>PE4658</b>	\$16.16	\$15.03	\$13.90	\$12.93	3
	Clamp/Solder	RG179, RG187	<b>PE4259</b>	\$32.37	\$30.10	\$27.84	\$25.90	4
		RG59, RG62	<b>PE4258</b>	\$32.37	\$30.10	\$27.84	\$25.90	5
<b>Plug Right Angle, Cable Connectors</b>								
	Crimp/Solder	RG179, RG187	<b>PE4252</b>	\$24.88	\$23.14	\$21.40	\$19.90	6
		RG180, RG195	<b>PE4162</b>	\$24.88	\$23.14	\$21.40	\$19.90	7
	Clamp/Solder	RG180, RG195	<b>PE4267</b>	\$24.88	\$23.14	\$21.40	\$19.90	8
		RG59, RG62	<b>PE4266</b>	\$24.88	\$23.14	\$21.40	\$19.90	9
<b>Jack Straight, Cable Connectors</b>								
	Crimp/Solder	RG179, RG187	<b>PE4254</b>	\$23.66	\$22.00	\$20.35	\$18.93	10
		RG180, RG195	<b>PE4164</b>	\$23.66	\$22.00	\$20.35	\$18.93	11
	Clamp/Solder	RG179, RG187	<b>PE4929</b>	\$23.66	\$22.00	\$20.35	\$18.93	12
		RG180, RG195	<b>PE4275</b>	\$23.66	\$22.00	\$20.35	\$18.93	13
		RG59, RG62	<b>PE4274</b>	\$23.66	\$22.00	\$20.35	\$18.93	14
<b>Jack Straight, Bulkhead Mount, Cable Connectors</b>								
	Crimp/Solder	RG179, RG187, B01 Mounting Hole	<b>PE4256</b>	\$23.66	\$22.00	\$20.35	\$18.93	15
		RG180, RG195, B01 Mounting Hole	<b>PE4166</b>	\$23.66	\$22.00	\$20.35	\$18.93	16
	Clamp/Solder	RG179, RG187, B01 Mounting Hole	<b>PE4906</b>	\$29.13	\$27.09	\$25.05	\$23.30	17
		RG180, RG195, B01 Mounting Hole	<b>PE4283</b>	\$23.66	\$22.00	\$20.35	\$18.93	18
		RG59, RG62, B01 Mounting Hole	<b>PE4282</b>	\$23.66	\$22.00	\$20.35	\$18.93	19
<b>Plug Straight, Bulkhead Mount, Terminal</b>								
	Solder	Solder Cup Contact, Front Mount, .125" Max Panel, B03 Mounting Hole	<b>PE4291</b>	\$32.37	\$30.10	\$27.84	\$25.90	20
<b>Jack Straight, Bulkhead Mount, Terminal</b>								
	Solder	Solder Cup Contact, Front Mount, .093" Max Panel, B03 Mounting Hole	<b>PE4173</b>	\$12.97	\$12.06	\$11.15	\$10.38	21
		Solder Cup Contact, Rear Mount, .093" Max Panel, B03 Mounting Hole	<b>PE4169</b>	\$28.73	\$26.72	\$24.71	\$22.98	22
<b>Jack Right Angle, Bulkhead Mount, Terminal</b>								
	Solder	Solder Cup Contact, Front Mount, .135" Max Panel, B03 Mounting Hole	<b>PE4287</b>	\$43.52	\$40.47	\$37.43	\$34.82	23
<b>Plug Straight, PCB Mount</b>								
	Solder	.036" Dia. Contact, .155" Leg Length, Thru Hole, D02 Mounting Hole	<b>PE4369</b>	\$27.36	\$25.44	\$23.53	\$21.89	24
<b>Plug Right Angle, PCB Mount</b>								
	Solder	.037" Dia. Contact, .155" Max Panel, Thru Hole, D02 Mounting Hole	<b>PE4293</b>	\$33.64	\$31.29	\$28.93	\$26.91	25







Connectors

See Our Website For Real-Time Stock Availability!

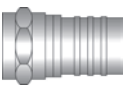
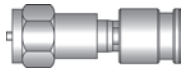
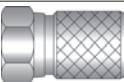
# 75 Ohm SMC Connectors (These Connectors will not mate with any 50 Ohm SMC Connectors)

Product Image	Attachment Cable/Contact	Coax Type / Termination Type	Model No.	Price				Row
				1-24	25-49	50-99	100 +	
<b>Jack Straight, PCB Mount</b>								
	Solder	.037" Dia. Contact, .155" Leg Length, Thru Hole, D02 Mounting Hole	PE4176	\$12.41	\$11.54	\$10.67	\$9.93	1
<b>Jack Right Angle, PCB Mount</b>								
	Solder	.037" Dia. Contact, .155" Max Panel, Thru Hole, D02 Mounting Hole	PE4180	\$19.91	\$18.52	\$17.12	\$15.93	2

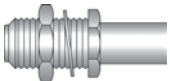

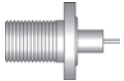
# 75 Ohm F Connectors

Product Image	Attachment Cable/Contact	Coax Type / Termination Type	Model No.	Price				Row
				1-24	25-49	50-99	100 +	
<b>Male Straight, Cable Connectors</b>								
	Crimp/Solder	PE-B159 Precision, High Definition, 1 Pieces Per Pack	PE44582	\$3.34	\$3.11	\$2.87	\$2.67	3
		RG6-Catv, 3 Piece Connector, 5 Pieces Per Pack	PE44313	\$3.09	\$2.87	\$2.66	\$2.47	4
		RG6-Catv, 10 Pieces Per Pack	PE44452	\$1.01	\$0.94	\$0.87	\$0.81	5
		RG179, RG187, 3 Piece Connector, 10 Pieces Per Pack	PE44319	\$2.03	\$1.89	\$1.75	\$1.62	6
		RG59, RG62, 10 Pieces Per Pack	PE44316	\$0.89	\$0.83	\$0.77	\$0.71	7
		RG59, RG62, 3 Piece Connector, 10 Pieces Per Pack	PE44317	\$2.31	\$2.15	\$1.99	\$1.85	8
		RG11, 3 Piece Connector, 5 Pieces Per Pack	PE44315	\$4.10	\$3.81	\$3.53	\$3.28	9
	Compression	RG6, 10 Pieces Per Pack	PE44312	\$1.10	\$1.02	\$0.95	\$0.88	10
		Mini 59, High Definition, 1 Piece Per Pack	PE44573	\$4.76	\$4.43	\$4.09	\$3.81	11
	Twist	PE-B159 Precision, High Definition, 1 Piece Per Pack	PE44572	\$4.41	\$4.10	\$3.79	\$3.53	12
		RG59, RG62, 10 Pieces Per Pack	PE44318	\$0.91	\$0.85	\$0.78	\$0.73	13
		RG6, 10 Pieces Per Pack	PE44314	\$0.91	\$0.85	\$0.78	\$0.73	14
<b>Male Right Angle, Cable Connectors</b>								
	Crimp/Solder	RG6-Catv, 5 Pieces Per Pack	PE44320	\$3.19	\$2.97	\$2.74	\$2.55	15
		RG59, RG62, 5 Pieces Per Pack	PE44322	\$4.15	\$3.86	\$3.57	\$3.32	16
	Compression	Mini 59, High Definition, 1 Piece Per Pack	PE44579	\$9.47	\$8.81	\$8.14	\$7.58	17
	Twist	RG6-Catv, 5 Pieces Per Pack	PE44321	\$3.39	\$3.15	\$2.92	\$2.71	18
		RG59, RG62, 5 Pieces Per Pack	PE44323	\$3.39	\$3.15	\$2.92	\$2.71	19
<b>Female Straight, Bulkhead Mount, Cable Connectors</b>								
	Crimp/Solder	RG6-Catv, B04 Mounting Hole, 5 Pieces Per Pack	PE44324	\$2.94	\$2.73	\$2.53	\$2.35	20
		RG179, RG187, G07 Mounting Hole, 5 Pieces Per Pack	PE44326	\$3.20	\$2.98	\$2.75	\$2.56	21
		RG59, RG62, B04 Mounting Hole, 5 Pieces Per Pack	PE44325	\$2.94	\$2.73	\$2.53	\$2.35	22
		PE-B159 Precision, High Definition, 1 Piece Per Pack, B06 Mounting Hole	PE44585	\$4.76	\$4.43	\$4.09	\$3.81	23
<b>Female Straight, Bulkhead Mount, Terminal</b>								
	Solder	.085" x .020" Tab Contact, Front Mount, .093" Max Panel, G07 Mounting Hole, 10 Pieces Per Pack	PE44327	\$1.22	\$1.13	\$1.05	\$0.98	24
		Pin Contact, Front Mount, .125" Max Panel, F05 Mounting Hole, 10 Pieces Per Pack	PE44330	\$1.52	\$1.41	\$1.31	\$1.22	25
<b>Female Straight, Panel Mount, Terminal</b>								
	Solder	4 Hole Flange, .030" Dia. Contact, A04 Mounting Hole, 5 Pieces Per Pack	PE44329	\$4.41	\$4.10	\$3.79	\$3.53	26



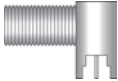

Connectors

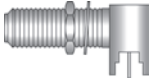
See Our Website For Real-Time Stock Availability!

# 75 Ohm F Connectors

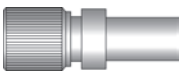
Product Image	Attachment Cable/Contact	Coax Type / Termination Type	Model No.	Price				Row
				1-24	25-49	50-99	100 +	
<b>Female Straight, PCB Mount</b>								
	Solder	.020" x .085" Tab Contact, .095" Leg Length, Thru Hole, D13 Mounting Hole, 10 Pieces Per Pack	PE44331	\$1.26	\$1.17	\$1.08	\$1.01	1
<b>Female Right Angle, PCB Mount</b>								
	Solder	.025" Dia. Contact, Thru Hole, D11 Mounting Hole, 5 Pieces Per Pack	PE44333	\$4.56	\$4.24	\$3.92	\$3.65	2
<b>Female Straight, Bulkhead Mount, PCB Mount</b>								
	Solder	.039" Dia. Contact, .300" Max Panel, Thru Hole, D14 Mounting Hole, 5 Pieces Per Pack	PE44332	\$4.41	\$4.10	\$3.79	\$3.53	3
<b>Female Right Angle, Bulkhead Mount, PCB Mount</b>								
	Solder	.025" Dia. Contact, .500" Max Panel, Thru Hole, D11 & B04 Mounting Hole, 5 Pieces Per Pack	PE44334	\$5.14	\$4.78	\$4.42	\$4.11	4

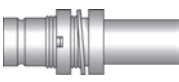
# 75 Ohm 1.6/5.6 Connectors

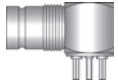



Product Image	Attachment Cable/Contact	Coax Type / Termination Type	Model No.	Price				Row
				1-24	25-49	50-99	100 +	
<b>Plug Straight, Cable Connectors</b>								
	Crimp/Solder	RG179, RG187	PE44262	\$11.60	\$10.79	\$9.98	\$9.28	5
		RG59	PE44263	\$10.99	\$10.22	\$9.45	\$8.79	6
<b>Plug Right Angle, Cable Connectors</b>								
	Clamp/Solder	RG179, RG187	PE44264	\$14.24	\$13.24	\$12.25	\$11.39	7
		RG59	PE44265	\$14.24	\$13.24	\$12.25	\$11.39	8
<b>Jack Straight, Bulkhead Mount, Cable Connectors</b>								
	Crimp/Solder	RG179, RG187, G04 Mounting Hole	PE44266	\$12.21	\$11.36	\$10.50	\$9.77	9
		RG59, G04 Mounting Hole	PE44267	\$12.97	\$12.06	\$11.15	\$10.38	10
<b>Jack Right Angle, Bulkhead Mount, Cable Connectors</b>								
	Crimp/Solder	RG179, RG187, G04 Mounting Hole	PE44268	\$14.24	\$13.24	\$12.25	\$11.39	11
		RG59, G04 Mounting Hole	PE44269	\$14.24	\$13.24	\$12.25	\$11.39	12
<b>Jack Straight, Bulkhead Mount, PCB Mount</b>								
	Solder	.039" Dia. Contact, .093" Max Panel, Thru Hole, D06 & F08 Mounting Hole	PE44270	\$12.97	\$12.06	\$11.15	\$10.38	13
<b>Jack Right Angle, PCB Mount</b>								
	Solder	.039" Dia. Contact, .130" Leg Length, Thru Hole, D06 Mounting Hole	PE44271	\$14.24	\$13.24	\$12.25	\$11.39	14

Connectors

See Our Website For Real-Time Stock Availability!

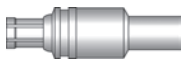
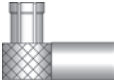
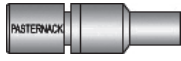
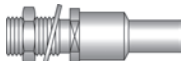

# 75 Ohm MCX Connectors

Product Image	Attachment Cable/Contact	Coax Type / Termination Type	Model No.	Price				Row
				1-24	25-49	50-99	100 +	
<b>Plug Straight, Cable Connectors</b>								
	Crimp/Solder	RG179, RG187	PE44298	\$11.30	\$10.51	\$9.72	\$9.04	1
<b>Plug Right Angle, Cable Connectors</b>								
	Crimp/Solder	RG179, RG187	PE44299	\$14.24	\$13.24	\$12.25	\$11.39	2
<b>Jack Straight, Cable Connectors</b>								
	Crimp/Solder	RG179, RG187	PE44300	\$18.59	\$17.29	\$15.99	\$14.87	3
<b>Jack Straight, Bulkhead Mount, Cable Connectors</b>								
	Crimp/Solder	RG179, RG187, B01 Mounting Hole	PE44301	\$31.11	\$28.93	\$26.75	\$24.89	4
<b>Jack Straight, Bulkhead Mount, Terminal</b>								
	Solder	Solder Cup Contact, .125" Max Panel, B02 Mounting Hole	PE44306	\$18.59	\$17.29	\$15.99	\$14.87	5
<b>Plug Straight, PCB Mount</b>								
	Solder	.027" Dia. Contact, .155" Leg Length, Thru Hole, D10 Mounting Hole	PE44307	\$16.16	\$15.03	\$13.90	\$12.93	6
<b>Jack Straight, PCB Mount</b>								
	Solder	.068" End Launch, .028" Round Contact, .125" Leg Length	PE44305	\$11.60	\$10.79	\$9.98	\$9.28	7
		Surface Mount	PE44302	\$16.16	\$15.03	\$13.90	\$12.93	8
		.028" Dia. Contact, .155" Leg Length, Thru Hole, D08 Mounting Hole	PE44303	\$11.10	\$10.32	\$9.55	\$8.88	9
<b>Jack Right Angle, PCB Mount</b>								
	Solder	.020" Dia. Contact, .155" Leg Length, Thru Hole, D09 Mounting Hole	PE44304	\$16.72	\$15.55	\$14.38	\$13.38	10



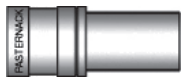
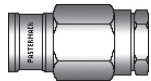









# 75 Ohm SMB Connectors (These Connectors will not mate with any 50 Ohm SMB Connectors)

Product Image	Attachment Cable/Contact	Coax Type / Termination Type	Model No.	Price				Row
				1-24	25-49	50-99	100 +	
<b>Plug Straight, Cable Connectors</b>								
	Crimp/Solder	RG179, RG187	PE4248	\$13.43	\$12.49	\$11.55	\$10.74	11
		RG179, RG187, Positive Snap, Will Mate to Standard 75 Ohm SMB Jack Connectors	PE44443	\$24.88	\$23.14	\$21.40	\$19.90	12
		RG180, RG195	PE4157	\$13.43	\$12.49	\$11.55	\$10.74	13
		RG180, RG195, Positive Snap, Will Mate to Standard 75 Ohm SMB Jack Connectors	PE44444	\$24.88	\$23.14	\$21.40	\$19.90	14
		RG59, RG62	PE4472	\$16.87	\$15.69	\$14.51	\$13.50	15
		RG59, RG62, Positive Snap, Will Mate to Standard 75 Ohm SMB Jack Connectors	PE44442	\$24.88	\$23.14	\$21.40	\$19.90	16
	Clamp/Solder	RG179, RG187	PE4257	\$17.63	\$16.40	\$15.16	\$14.10	17
		RG59, RG62	PE4203	\$15.60	\$14.51	\$13.42	\$12.48	18

Connectors

See Our Website For Real-Time Stock Availability!

# 75 Ohm SMB Connectors (These Connectors will not mate with any 50 Ohm SMB Connectors)

Product Image	Attachment Cable/Contact	Coax Type / Termination Type	Model No.	Price				Row
				1-24	25-49	50-99	100 +	
<b>Plug Right Angle, Cable Connectors</b>								
	Crimp/Solder	RG179, RG187	PE4251	\$19.25	\$17.90	\$16.56	\$15.40	1
		RG179, RG187, Positive Snap, Will Mate to Standard 75 Ohm SMB Jack Connectors	PE44445	\$27.36	\$25.44	\$23.53	\$21.89	2
		RG180, RG195	PE4161	\$24.88	\$23.14	\$21.40	\$19.90	3
		RG180, RG195, Positive Snap, Will Mate to Standard 75 Ohm SMB Jack Connectors	PE44446	\$27.36	\$25.44	\$23.53	\$21.89	4
	Clamp/Solder	RG180, RG195	PE4265	\$24.88	\$23.14	\$21.40	\$19.90	5
		RG59, RG62	PE4264	\$32.37	\$30.10	\$27.84	\$25.90	6
<b>Jack Straight, Cable Connectors</b>								
	Crimp/Solder	RG179, RG187	PE4253	\$32.37	\$30.10	\$27.84	\$25.90	7
		RG180, RG195	PE4163	\$16.87	\$15.69	\$14.51	\$13.50	8
	Clamp/Solder	RG179, RG187	PE4928	\$32.37	\$30.10	\$27.84	\$25.90	9
		RG180, RG195	PE4273	\$24.88	\$23.14	\$21.40	\$19.90	10
		RG59, RG62	PE4272	\$24.88	\$23.14	\$21.40	\$19.90	11
<b>Jack Straight, Bulkhead Mount, Cable Connectors</b>								
	Crimp/Solder	RG179, RG187, B01 Mounting Hole	PE4255	\$32.37	\$30.10	\$27.84	\$25.90	12
		RG180, RG195, B01 Mounting Hole	PE4165	\$29.79	\$27.70	\$25.62	\$23.83	13
	Clamp/Solder	RG179, RG187, B01 Mounting Hole	PE4925	\$22.09	\$20.54	\$19.00	\$17.67	14
		RG180, RG195, B01 Mounting Hole	PE4281	\$22.09	\$20.54	\$19.00	\$17.67	15
		RG59, RG62, B01 Mounting Hole	PE4280	\$35.77	\$33.27	\$30.76	\$28.62	16
<b>Plug Straight, Bulkhead Mount, Terminal</b>								
	Solder	Solder Cup Contact, Front Mount, .175" Max Panel, B03 Mounting Hole	PE4290	\$43.52	\$40.47	\$37.43	\$34.82	17
<b>Jack Straight, Terminal</b>								
	Solder	.038" Dia. Contact, .155" Leg Length, D02 Mounting Hole	PE4110	\$13.98	\$13.00	\$12.02	\$11.18	18
<b>Jack Straight, Bulkhead Mount, Terminal</b>								
	Solder	Solder Cup Contact, Front Mount, .093" Max Panel, B03 Mounting Hole	PE4172	\$12.97	\$12.06	\$11.15	\$10.38	19
		Solder Cup Contact, Rear Mount, .093" Max Panel, F10 Mounting Hole	PE4168	\$12.97	\$12.06	\$11.15	\$10.38	20
<b>Jack Right Angle, Bulkhead Mount, Terminal</b>								
	Solder	Solder Cup Contact, Front Mount, .093" Max Panel, B03 Mounting Hole	PE4286	\$49.91	\$46.42	\$42.92	\$39.93	21
<b>Plug Straight, PCB Mount</b>								
	Solder	.037" Dia. Contact, .155" Leg Length, Thru Hole, D02 Mounting Hole	PE4368	\$21.13	\$19.65	\$18.17	\$16.90	22
<b>Plug Right Angle, PCB Mount</b>								
	Solder	.037" Dia. Contact, .155" Leg Length, Thru Hole, D02 Mounting Hole	PE4292	\$42.76	\$39.77	\$36.77	\$34.21	23
<b>Jack Right Angle, PCB Mount</b>								
	Solder	.037" Dia. Contact, .155" Leg Length, Thru Hole, D02 Mounting Hole	PE4179	\$17.89	\$16.64	\$15.39	\$14.31	24

Connectors





See Our Website For Real-Time Stock Availability!

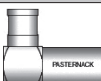

# 75 Ohm MINI SMB Connectors (These Connectors will not mate with any 50 Ohm SMB Connectors)

Connectors

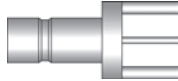

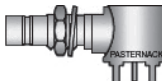

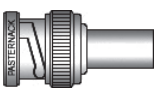
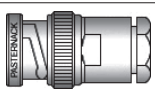

See Our Website For Real-Time Stock Availability!

Product Image	Attachment Cable/Contact	Coax Type / Termination Type	Model No.	Price				Row
				1-24	25-49	50-99	100 +	
<b>Plug Straight, Cable Connectors</b>								
	Crimp/Solder	RG179, RG187	PE4993	\$12.11	\$11.26	\$10.41	\$9.69	1
		RG59, RG62	PE4994	\$15.21	\$14.15	\$13.08	\$12.17	2
		PE-B159 Precision, High Definition	PE44588	\$21.48	\$19.98	\$18.47	\$17.18	3
<b>Plug Right Angle, Cable Connectors</b>								
	Crimp/Solder	RG179, RG187	PE4995	\$14.44	\$13.43	\$12.42	\$11.55	4
		RG59, RG62	PE4996	\$21.13	\$19.65	\$18.17	\$16.90	5
		PE-B159 Precision, High Definition	PE44589	\$26.19	\$24.36	\$22.52	\$20.95	6
<b>Jack Straight, Cable Connectors</b>								
	Crimp/Solder	PE-B159 Precision, High Definition	PE44590	\$20.27	\$18.85	\$17.43	\$16.22	7
<b>Jack Straight, Panel Mount, Terminal</b>								
	Solder	2 Hole Flange, Solder Cup Contact, C07 Mounting Hole	PE44141	\$17.63	\$16.40	\$15.16	\$14.10	8
<b>Jack Straight, PCB Mount</b>								
	Solder	.042" End Launch, .020" Round Contact, .187" Leg Length	PE44134	\$16.16	\$15.03	\$13.90	\$12.93	9
		.062" End Launch, .020" Round Contact, .187" Leg Length	PE44131	\$16.57	\$15.41	\$14.25	\$13.26	10
		.020" Dia. Contact, .155" Leg Length, Thru Hole, D09 Mounting Hole	PE4997	\$10.99	\$10.22	\$9.45	\$8.79	11
<b>Jack Right Angle, PCB Mount</b>								
	Solder	.020" Dia. Contact, Thru Hole, D09 Mounting Hole	PE4998	\$15.96	\$14.84	\$13.73	\$12.77	12
<b>Jack Straight, Bulkhead Mount, PCB Mount</b>								
	Solder	.020" Dia. Contact, .155" Leg Length, .093" Max Panel, Thru Hole, B01 & D09 Mounting Hole	PE44125	\$31.11	\$28.93	\$26.75	\$24.89	13
<b>Jack Right Angle, Bulkhead Mount, PCB Mount</b>								
	Solder	.020" Dia. Contact, .093" Max Panel, Thru Hole, B01 & D09 Mounting Hole	PE44128	\$19.96	\$18.56	\$17.17	\$15.97	14

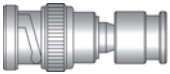
# 75 Ohm BNC Connectors

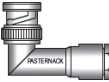
Product Image	Attachment Cable/Contact	Coax Type / Termination Type	Model No.	Price				Row		
				1-24	25-49	50-99	100 +			
<b>Male Straight, Cable Connectors</b>										
	Crimp/Solder	PE-B159 Precision, High Definition	PE44584	\$11.30	\$10.51	\$9.72	\$9.04	15		
		PE-B150	PE4633	\$10.74	\$9.99	\$9.24	\$8.59	16		
		PE-B305	PE4634	\$11.60	\$10.79	\$9.98	\$9.28	17		
		Mini 59, PE-B159, 3 Piece Connector	PE44625	\$7.09	\$6.59	\$6.10	\$5.67	18		
		Mini 59, PE-B159, High Definition	PE44630	\$11.30	\$10.51	\$9.72	\$9.04	19		
		RG179, RG187	PE4604	\$11.15	\$10.37	\$9.59	\$8.92	20		
		RG179-DS, 179DT, High Definition	PE44629	\$10.69	\$9.94	\$9.19	\$8.55	21		
		RG59	PE4602	\$10.99	\$10.22	\$9.45	\$8.79	22		
		PE-B1505, High Definition	PE44631	\$11.30	\$10.51	\$9.72	\$9.04	23		
		PE-B1694, High Definition	PE44632	\$11.30	\$10.51	\$9.72	\$9.04	24		
		RG11	PE4600	\$14.69	\$13.66	\$12.63	\$11.75	25		
		RG6	PE4598	\$15.81	\$14.70	\$13.60	\$12.65	26		
			Clamp/Solder	RG179, RG187	PE4603	\$10.99	\$10.22	\$9.45	\$8.79	27
				RG59	PE4601	\$11.70	\$10.88	\$10.06	\$9.36	28
RG11, RG216	PE4599			\$21.13	\$19.65	\$18.17	\$16.90	29		
RG6	PE4597			\$16.87	\$15.69	\$14.51	\$13.50	30		

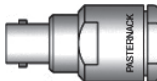
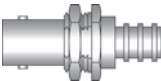
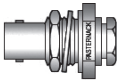
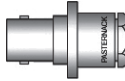
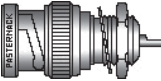
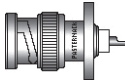
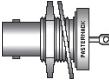



# 75 Ohm BNC Connectors

Product Image	Attachment Cable/Contact	Coax Type / Termination Type	Model No.	Price				Row
				1-24	25-49	50-99	100 +	
	Compression	Mini 59, High Definition	PE44578	\$11.86	\$11.03	\$10.20	\$9.49	1
		PE-B159 Precision, High Definition	PE44577	\$11.25	\$10.46	\$9.68	\$9.00	2
<b>Male Right Angle, Cable Connectors</b>								
	Crimp/Solder	RG179, RG187	PE4610	\$20.11	\$18.70	\$17.29	\$16.09	3
		RG59	PE4608	\$25.43	\$23.65	\$21.87	\$20.34	4
	Clamp/Solder	RG179, RG187	PE4609	\$24.88	\$23.14	\$21.40	\$19.90	5
		RG59	PE4607	\$22.34	\$20.78	\$19.21	\$17.87	6
		RG11, RG216	PE4606	\$27.36	\$25.44	\$23.53	\$21.89	7
		RG6	PE4605	\$22.34	\$20.78	\$19.21	\$17.87	8
	Compression	Mini 59, High Definition	PE44581	\$15.45	\$14.37	\$13.29	\$12.36	9
<b>Female Straight, Cable Connectors</b>								
	Crimp/Solder	RG179, RG187	PE4616	\$13.22	\$12.29	\$11.37	\$10.58	10
		RG59	PE4614	\$14.24	\$13.24	\$12.25	\$11.39	11
	Clamp/Solder	RG179, RG187	PE4615	\$18.59	\$17.29	\$15.99	\$14.87	12
		RG59	PE4613	\$14.08	\$13.09	\$12.11	\$11.26	13
		RG11, RG216	PE4612	\$20.77	\$19.32	\$17.86	\$16.62	14
		RG6	PE4611	\$32.37	\$30.10	\$27.84	\$25.90	15
<b>Female Straight, Bulkhead Mount, Cable Connectors</b>								
	Crimp/Solder	PE-B159, 1855A, B06 Mounting Hole	PE44587	\$15.45	\$14.37	\$13.29	\$12.36	16
		PE-B150, B06 Mounting Hole	PE4641	\$19.40	\$18.04	\$16.68	\$15.52	17
		PE-B305, B06 Mounting Hole	PE4642	\$19.40	\$18.04	\$16.68	\$15.52	18
		RG179, RG187, B06 Mounting Hole	PE4640	\$16.36	\$15.21	\$14.07	\$13.09	19
		RG59, B06 Mounting Hole	PE4638	\$20.82	\$19.36	\$17.91	\$16.66	20
	Clamp/Solder	RG179, RG187, B06 Mounting Hole	PE4639	\$22.30	\$20.74	\$19.18	\$17.84	21
		RG59, B06 Mounting Hole	PE4637	\$19.00	\$17.67	\$16.34	\$15.20	22
		RG11, RG216, B06 Mounting Hole	PE4636	\$37.34	\$34.73	\$32.11	\$29.87	23
		RG6, B06 Mounting Hole	PE4635	\$37.34	\$34.73	\$32.11	\$29.87	24
		<b>Female Straight, Panel Mount, Cable Connectors</b>						
	Clamp/Solder	4 Hole Flange, RG179, RG187, A03 Mounting Hole	PE44652	\$26.75	\$24.88	\$23.01	\$21.40	25
		4 Hole Flange, RG59, A03 Mounting Hole	PE4623	\$24.88	\$23.14	\$21.40	\$19.90	26
<b>Male Straight, Bulkhead Mount, Terminal</b>								
	Solder	Solder Cup Contact, .200" Max Panel, B04 Mounting Hole	PE4627	\$15.60	\$14.51	\$13.42	\$12.48	27
<b>Male Straight, Panel Mount, Terminal</b>								
	Solder	4 Hole Flange, Solder Cup Contact, A07 Mounting Hole	PE4625	\$15.96	\$14.84	\$13.73	\$12.77	28
<b>Female Straight, Bulkhead Mount, Terminal</b>								
	Solder	Solder Cup Contact, .250" Max Panel, B04 Mounting Hole	PE4620	\$9.68	\$9.00	\$8.32	\$7.74	29
		Solder Cup Contact, .125" Max Panel, B05 Mounting Hole	PE4619	\$6.66	\$6.19	\$5.73	\$5.33	30
		Wire Terminal, Rear Mount, Hermetically Sealed, .225" Max Panel, B06 Mounting Hole	PE4621	\$25.38	\$23.60	\$21.83	\$20.30	31
		Wire Terminal, Front Mount, Hermetically Sealed, .300" Max Panel, B04 Mounting Hole	PE4624	\$25.13	\$23.37	\$21.61	\$20.10	32
		Solder Cup Contact, Isolated Ground, .187" Max Panel, B06 Mounting Hole	PE4629	\$14.69	\$13.66	\$12.63	\$11.75	33
		Solder Cup Contact, Isolated Ground, .125" Max Panel, B04 Mounting Hole	PE4626	\$8.56	\$7.96	\$7.36	\$6.85	34
<b>Female Right Angle, Bulkhead Mount, Terminal</b>								
	Solder	Solder Cup Contact, .300" Max Panel, B13 Mounting Hole	PE4622	\$40.79	\$37.93	\$35.08	\$32.63	35

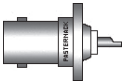

Connectors

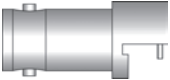
See Our Website For Real-Time Stock Availability!



# 75 Ohm BNC Connectors

Product Image	Attachment Cable/Contact	Coax Type / Termination Type	Model No.	Price				Row
				1-24	25-49	50-99	100 +	
<b>Female Straight, Panel Mount, Terminal</b>								
	Solder	4 Hole Flange, Solder Cup Contact, A03 Mounting Hole	PE4617	\$10.34	\$9.62	\$8.89	\$8.27	1
		4 Hole Flange, Solder Cup Contact, .687" Flange Size, A04 Mounting Hole	PE4630	\$12.97	\$12.06	\$11.15	\$10.38	2
		4 Hole Flange, Solder Cup Contact, 1.00" Flange Size, A05 Mounting Hole	PE4631	\$18.59	\$17.29	\$15.99	\$14.87	3
		4 Hole Flange, Turret, A07 Mounting Hole	PE4618	\$29.79	\$27.70	\$25.62	\$23.83	4
<b>Female Right Angle, Panel Mount, Terminal</b>								
	Solder	4 Hole Flange, Solder Cup Contact, A16 Mounting Hole	PE4628	\$37.34	\$34.73	\$32.11	\$29.87	5
<b>Female Straight, PCB Mount</b>								
	Solder	Surface Mount, Edge Launch Grip	PE44619	\$11.86	\$11.03	\$10.20	\$9.49	6
<b>Female Straight, Bulkhead Mount, PCB Mount</b>								
	Solder	Surface Mount, Edge Launch Grip, .110" Max Panel, F02 Mounting Hole	PE44620	\$12.87	\$11.97	\$11.07	\$10.30	7

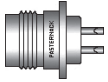
# 3/4"-20 Threaded Twinax Connectors

Product Image	Attachment Cable/Contact	Coax Type / Termination Type	Model No.	Price				Row
				1-24	25-49	50-99	100 +	
<b>Male Straight, Cable Connectors</b>								
	Clamp/Solder	PE-S330	PE4104	\$17.73	\$16.49	\$15.25	\$14.18	8
<b>Female Straight, Cable Connectors</b>								
	Clamp/Solder	PE-S330	PE4346	\$18.24	\$16.96	\$15.69	\$14.59	9
<b>Female Straight, Bulkhead Mount, Terminal</b>								
	Solder	Solder Cup Contact, B07 Mounting Hole	PE4105	\$18.24	\$16.96	\$15.69	\$14.59	10
<b>Female Straight, Panel Mount, Terminal</b>								
	Solder	4 Hole Flange, Solder Cup Contact, A05 Mounting Hole	PE4347	\$22.09	\$20.54	\$19.00	\$17.67	11

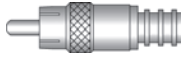
# RCA Connectors

Product Image	Attachment Cable/Contact	Coax Type / Termination Type	Model No.	Price				Row
				1-24	25-49	50-99	100 +	
<b>Plug Straight, Cable Connectors</b>								
	Crimp/Solder	PE-B159 Precision, High Definition	PE44583	\$7.09	\$6.59	\$6.10	\$5.67	12
		Mini 59, PE-B159, High Definition (3 Pieces)	PE44622	\$10.74	\$9.99	\$9.24	\$8.59	13
	Compression	Mini 59, High Definition	PE44576	\$8.31	\$7.73	\$7.15	\$6.65	14
		PE-B159 Precision, High Definition	PE44574	\$8.31	\$7.73	\$7.15	\$6.65	15
		PE-B159 Precision, All Gold, High Definition	PE44575	\$11.86	\$11.03	\$10.20	\$9.49	16

Connectors

See Our Website For Real-Time Stock Availability!

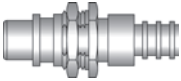

# RCA Connectors

Product Image	Attachment Cable/Contact	Coax Type / Termination Type	Model No.	Price				Row
				1-24	25-49	50-99	100 +	
<b>Plug Right Angle, Cable Connectors</b>								
	Compression	Mini 59, High Definition	PE44580	\$14.24	\$13.24	\$12.25	\$11.39	1
<b>Jack Straight, Bulkhead Mount, Cable Connectors</b>								
	Crimp/Solder	PE-B159, High Definition, B06 Mounting Hole	PE44586	\$11.86	\$11.03	\$10.20	\$9.49	2

# Banana Plug Connectors

Product Image	Attachment Cable/Contact	Coax Type / Termination Type	Model No.	Price				Row
				1-24	25-49	50-99	100 +	
<b>Plug Straight, Cable Connectors</b>								
	Crimp/Solder	RG174, RG316, RG188	PE44145	\$11.20	\$10.42	\$9.63	\$8.96	3
		RG58	PE4301	\$6.28	\$5.84	\$5.40	\$5.02	4
		RG55, RG142, RG223, RG400	PE4089	\$7.90	\$7.35	\$6.79	\$6.32	5

# BNC Twinax Connectors

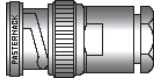
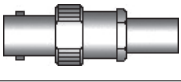
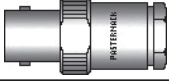
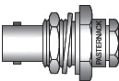
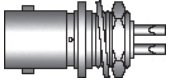
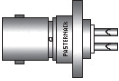
Product Image	Attachment Cable/Contact	Coax Type / Termination Type	Model No.	Price				Row
				1-24	25-49	50-99	100 +	
<b>Plug Straight, Cable Connectors</b>								
	Crimp/Solder	RG108, 78 Ohm Twinax	PE4234	\$15.47	\$14.39	\$13.30	\$12.38	6
	Clamp/Solder	RG108, 78 Ohm Twinax	PE4236	\$19.96	\$18.56	\$17.17	\$15.97	7
<b>Jack Straight, Cable Connectors</b>								
	Crimp/Solder	RG108, 78 Ohm Twinax	PE4235	\$24.88	\$23.14	\$21.40	\$19.90	8
	Clamp/Solder	RG108, 78 Ohm Twinax	PE4237	\$24.88	\$23.14	\$21.40	\$19.90	9
<b>Jack Straight, Bulkhead Mount, Cable Connectors</b>								
	Clamp/Solder	RG108, 78 Ohm Twinax, B06 Mounting Hole	PE44114	\$34.83	\$32.39	\$29.95	\$27.86	10
<b>Jack Straight, Bulkhead Mount, Terminal</b>								
	Solder	Solder Cup Contact, B04 Mounting Hole	PE4238	\$13.90	\$12.93	\$11.95	\$11.12	11
<b>Jack Straight, Panel Mount, Terminal</b>								
	Solder	4 Hole Flange, Solder Cup Contact, A03 Mounting Hole	PE4324	\$17.63	\$16.40	\$15.16	\$14.10	12

Connectors

See Our Website For Real-Time Stock Availability!



# Adapter Selection Guide

## 3 Easy Ways to Find your Product.....

### 1. Search by PE Part Number

If you know the PE part number you are searching for, please reference our Part Number Index on Page 253.

### 2. Quick Reference Guide See pages 138-139 for our Adapter Matrix.

(Page number refers to first appearance of product in the Adapter Section)

Connector Series	Page	Connector Series	Page	Connector Series	Page	Connector Series	Page	Connector Series	Page
1.0/2.3	152	BNC-75 Ohm	176	MINI SMB-75 Ohm	176	Reverse Polarity MCX	152	SMC-75 Ohm	173
1.85mm	148	BNC Twinax	179	MINI SMP	155	Reverse Polarity N	159	SMP	151
10-32	167	C	162	MINI-UHF	160	Reverse Polarity SMA	147	SSMA	148
2.4mm	148	D-Sub Contacts	153	MMCX	151	Reverse Polarity TNC	150	SSMB	152
2.92mm	153	F	153	N-50 Ohm	148	Reverse Thread SMA	147	TNC-50 Ohm	149
3.5mm	147	FME	150	N-75 Ohm	162	SC	160	TNC-75 Ohm	175
3/4"-20 Twinax	178	GR874	153	PAL	175	SHV	174	UHF	150
7/16 DIN	150	HN	151	QMA	151	SMA	146	UMCX	151
7mm	154	LC	160	QN	161	SMB-50 Ohm	152		
Banana Plug	173	MCX	152	RCA	173	SMB-75 Ohm	173		
BNC-50 Ohm	152	MHV	169	Reverse Polarity BNC	172	SMC-50 Ohm	151		

Adapters

### Adapter Locator Layout

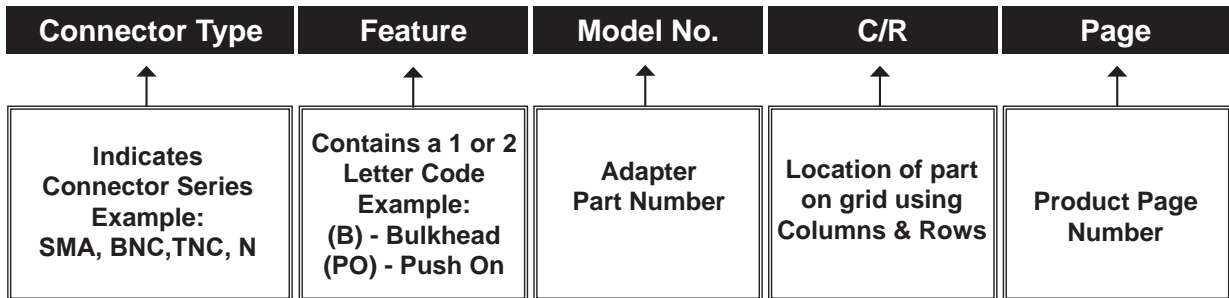

See Our Website For Real-Time Stock Availability!

### 3. Between-Series Adapter Locator

(Adapter Locator starts on Page 140)



SMA FEMALE TO TNC FEMALE  
PE9079

SMA Female To:		EXAMPLE		
Connector Type	Feature	Model No.	C/R	Page
SSMA Male		PE9188	A4	163
SSMB Plug		PE9402	A3	167
TNC Female		<b>PE9079</b>	D6	164
TNC Female	(B)	PE9201	A1	165

TNC Female To:		EXAMPLE		
Connector Type	Feature	Model No.	C/R	Page
SMA Female	(P)	PE9442	C6	164
SMA Female		<b>PE9079</b>	D6	164
SMA Female	(B)	PE9201	A1	165
SMA Female	(PM)	PE9276	B1	165

The Adapter Locator example above includes Between-Series part numbers in two configurations:

**Connector 1 to Connector 2 as well as Connector 2 to Connector 1 can be found in the same location.**

Products can only be found under the first instance of the series combination. As an example, PE9079 above will be found in only one location in the Adapter Section.

# Adapters Matrix

The number in the box represents the page number where the adapter is found.

Adapters

See Our Website For Real-Time Stock Availability!

Connectors	1.0 / 2.3	1.85mm	10-32	2.4mm	2.92mm	3.5mm	3/4"-20 Twinax	7/16	75 Ohm BNC	75 Ohm N	75 Ohm SMB	75 Ohm SMC	75 Ohm TNC	7mm	Binding Posts	BNC	C	Double Banana	D Subminiature	F	FME	GR874	HN
1.0 / 2.3																							
1.85mm		156		156	155	154																	
10-32			167													167							
2.4mm		156		155	155	154								156									
2.92mm		155		155	154	153								155									
3.5mm		154		154	153	153								154									
3/4"-20 Twinax							178																
7/16								164						165									165
75 Ohm BNC									178	176			176							177			
75 Ohm N									176	175	176	175	175							175			
75 Ohm SMB										176	177						173						
75 Ohm SMC										175		176				173							
75 Ohm TNC									176	175			176										
7mm				156	155	154		165								169							
Binding Posts																173							
BNC			167								173	173	169	173	173	172	172	173		173	166	173	169
C																172	174					174	169
Double Banana																173							
D Subminiature																			179				
F									177	175						173				177			
FME																166					166		
GR874																173	174					179	169
HN								165								169	169					169	168
LC																							168
MCX																170							
MHV																172							169
Mini 75 Ohm SMB									178		178												
Mini SMP					155																		
Mini UHF																166					166		
MMCX																170							
N		156		156	155	154		159	162					161			162			162	160	162	160
PAL																				177			
QMA																							
QN																							
RCA																173				177			
SC																168							
SHV																							
SMA	152	148		148		147		150						151		152			153	153	150	153	151
SMB																171							
SMC																167							
SMP																							
SSMA		156			155									157		157							
SSMB																171							
TNC								163						164		164	164				163		164
UHF																165				166	165		
UMCX																							

# Adapters Matrix

The number in the box represents the page number where the adapter is found.

Connectors																								
	LC	MCX	MHV	Mini 75 Ohm SMB	Mini SMP	Mini UHF	MMCX	N	PAL	QMA	QN	RCA	SC	SHV	SMA	SMB	SMC	SMP	SSMA	SSMB	TNC	UHF	UMCX	
1.0 / 2.3															152									
1.85mm								156							148					156				
10-32																								
2.4mm								156							148									
2.92mm					155			155												155				
3.5mm								154							147									
3/4"-20 Twinax																								
7/16								159							150							163		
75 Ohm BNC				178																				
75 Ohm N								162																
75 Ohm SMB				178																				
75 Ohm SMC																								
75 Ohm TNC																								
7mm								161							151					157		164		
Binding Posts																								
BNC		170	172			166	170						173	168	152	171	167		157	171	164	165		
C								162														164		
Double Banana																								
D Subminiature															153									
F								162	177			177			153								166	
FME						166		160							150						163	165		
GR874								162							153									
HN	168		169					160							151							164		
LC	168							160																
MCX		170					170	161							152							164		
MHV			174											174										
Mini 75 Ohm SMB				178																				
Mini SMP					170																			
Mini UHF						166																	165	
MMCX		170					170								151									
N	160	161						157		161	161		160		148	161	160		157		159	160		
PAL									175															
QMA								161							151									
QN								161																
RCA																								
SC								160					168											
SHV			174											174										
SMA		152					151	148		151					146	152	151	151	148	152	149	150	151	
SMB								161							152	171	167							
SMC								160							151	167	167					164		
SMP															151			169						
SSMA								157							148				157					
SSMB															152									
TNC		164						159							149		164					162	163	
UHF						165		160							150							163	165	
UMCX															151									

Adapters

See Our Website For Real-Time Stock Availability!



# Adapter Locator

Adapters

Connector Type	Feature	Model No.	C/R	Page
<b>1.0/2.3 Slide On Jack To:</b>				
SMA Female		PE9693	A5	152
SMA Male		PE9690	C4	152
<b>1.0/2.3 Slide On Plug To:</b>				
SMA Female		PE9691	D4	152
SMA Male		PE9692	B4	152
<b>1.85mm Female To:</b>				
2.4mm Female	(P)	PE9675	C2	156
2.4mm Male	(P)	PE9674	A2	156
2.92mm Female	(P)	PE9668	A3	155
2.92mm Male	(P)	PE9666	C2	155
3.5mm Female	(P)	PE9748	A3	154
3.5mm Male	(P)	PE9745	C2	154
N Female	(P)	PE9721	B1	157
N Male	(P)	PE9720	A1	157
SMA Female	(P)	PE9729	B3	148
SMA Male	(P)	PE9728	D2	148
SSMA Female	(P)	PE9765	B6	156
SSMA Male	(P)	PE9764	A6	156
<b>1.85mm In-Series:</b>				
Female To Female	(P)	PE9717	A5	156
Male To Female	(P)	PE9715	D4	156
Male To Male	(P)	PE9716	C4	156
<b>1.85mm Male To:</b>				
2.4mm Female	(P)	PE9673	B2	156
2.4mm Male	(P)	PE9672	D1	156
2.92mm Female	(P)	PE9665	D2	155
2.92mm Male	(P)	PE9667	B2	155
3.5mm Female	(P)	PE9747	D2	154
3.5mm Male	(P)	PE9746	B2	154
N Female	(P)	PE9719	D6	156
N Male	(P)	PE9718	C6	156
SMA Female	(P)	PE9726	A3	148
SMA Male	(P)	PE9727	C2	148
SSMA Female	(P)	PE9762	D5	156
SSMA Male	(P)	PE9763	C5	156
<b>10-32 Female To:</b>				
BNC Female		PE9752	C1	168
BNC Female	(B)	PE9754	D1	168
BNC Male		PE9750	B1	168
<b>10-32 In-Series:</b>				
Female To Female		PE9756	D5	167
Female To Female	(B)	PE9757	A6	167
<b>10-32 Male To:</b>				
BNC Female		PE9753	D6	167
BNC Female	(B)	PE9755	A1	168
BNC Male		PE9751	C6	167
<b>2.4mm Female To:</b>				
1.85mm Female	(P)	PE9675	C2	156
1.85mm Male	(P)	PE9673	B2	156
2.92mm Female	(P)	PE9456	A2	155
2.92mm Male	(P)	PE9455	C1	155
3.5mm Female	(P)	PE9652	A2	154
3.5mm Male	(P)	PE9651	C1	154
7mm	(P)	PE9459	A4	156
N Female	(P)	PE9502	C3	156
N Male	(P)	PE9503	B3	156
SMA Female	(P)	PE9656	B2	148
SMA Male	(P)	PE9654	D1	148
<b>2.4mm In-Series:</b>				
Female To Female	(P)	PE9453	A1	156
Female To Female	(P) (B)	PE9640	B1	156
Male To Female	(P)	PE9452	D6	155
Male To Male	(P)	PE9451	C6	155
<b>2.4mm Male To:</b>				
1.85mm Female	(P)	PE9674	A2	156
1.85mm Male	(P)	PE9672	D1	156
2.92mm Female	(P)	PE9454	D1	155
2.92mm Male	(P)	PE9457	B1	155
3.5mm Female	(P)	PE9650	D1	154
3.5mm Male	(P)	PE9649	B1	154
7mm	(P)	PE9458	D3	156
N Female	(P)	PE9501	A3	156
N Male	(P)	PE9504	D2	156
SMA Female	(P)	PE9655	A2	148
SMA Male	(P)	PE9653	C1	148
<b>2.92mm Female To:</b>				
1.85mm Female	(P)	PE9668	A3	155
1.85mm Male	(P)	PE9665	D2	155

Connector Type	Feature	Model No.	C/R	Page
2.4mm Female	(P)	PE9456	A2	155
2.4mm Male	(P)	PE9454	D1	155
3.5mm Female	(P)	PE9660	A1	154
3.5mm Male	(P)	PE9658	C6	153
7mm	(P)	PE9461	C5	155
Mini SMP Female	(P)	PE9782	A6	155
Mini SMP Male	(P)	PE9781	D5	155
N Female	(P)	PE9664	A5	155
N Male	(P)	PE9663	D4	155
SSMA Female	(P)	PE9769	A4	155
SSMA Male	(P)	PE9768	D3	155
<b>2.92mm In-Series:</b>				
Female To Female	(P)	PE9438	A6	154
Female To Female	(B) (P)	PE9647	B6	154
Female To Female	(PM) (P)	PE9648	C6	154
Female To Female	90° (P)	PE9646	D6	154
Male To Female	(P)	PE9437	C5	154
Male To Female	90° (P)	PE9644	D5	154
Male To Male	(P)	PE9436	A5	154
Male To Male	90° (P)	PE9645	B5	154
<b>2.92mm Male To:</b>				
1.85mm Female	(P)	PE9666	C2	155
1.85mm Male	(P)	PE9667	B2	155
2.4mm Female	(P)	PE9455	C1	155
2.4mm Male	(P)	PE9457	B1	155
3.5mm Female	(P)	PE9659	D6	153
3.5mm Male	(P)	PE9657	B6	153
7mm	(P)	PE9460	B5	155
N Female	(P)	PE9662	C4	155
N Male	(P)	PE9661	B4	155
SSMA Female	(P)	PE9766	C3	155
SSMA Male	(P)	PE9767	B3	155
<b>3.5mm Female To:</b>				
1.85mm Female	(P)	PE9748	A3	154
1.85mm Male	(P)	PE9747	D2	154
2.4mm Female	(P)	PE9652	A2	154
2.4mm Male	(P)	PE9650	D1	154
2.92mm Female	(P)	PE9660	A1	154
2.92mm Male	(P)	PE9659	D6	153
7mm	(P)	PE9325	C4	154
N Female	(P)	PE9323	A4	154
N Male	(P)	PE9321	D3	154
SMA Female	(P)	PE9725	B1	148
SMA Male	(P)	PE9723	D6	147
<b>3.5mm In-Series To:</b>				
Female To Female	(P)	PE9331	C5	153
Female To Female	(B) (P)	PE9678	D5	153
Female To Female	(PM) (P)	PE9676	A6	153
Male To Female	(P)	PE9332	D4	153
Male To Female	(B) (P)	PE9677	B5	153
Male To Male	(P)	PE9330	B4	153
Male To Male	(B) (P)	PE9679	C4	153
<b>3.5mm Male To:</b>				
1.85mm Female	(P)	PE9745	C2	154
1.85mm Male	(P)	PE9746	B2	154
2.4mm Female	(P)	PE9651	C1	154
2.4mm Male	(P)	PE9649	B1	154
2.92mm Female	(P)	PE9658	C6	153
2.92mm Male	(P)	PE9657	B6	153
7mm	(P)	PE9326	B4	154
N Female	(P)	PE9324	C3	154
N Male	(P)	PE9322	B3	154
SMA Female	(P)	PE9724	A1	148
SMA Male	(P)	PE9722	C6	147
<b>3/4"-20 Twinax In-Series:</b>				
Female To Female		PE9199	D6	178
Female To Female	(B)	PE9373	A1	179
T, Female-Female-Female		PE9224	C1	179
T, Female-Male-Female		PE9374	B1	179
<b>7/16 DIN Female To:</b>				
7mm	(P)	PE9510	D3	165
HN Female		PE9559	B3	165
N Female		PE9180	D1	160
N Female	(LP)	PE91033	C1	160
N Male		PE9178	D6	159
N Male	(LP)	PE91032	C6	159
SMA Female	(LP)	PE91042	D5	150
SMA Male		PE9411	A5	150
SMA Male	(LP)	PE91041	D4	150

Connector Type	Feature	Model No.	C/R	Page
TNC Female		PE9639	C5	163
TNC Male		PE9638	A5	163
<b>7/16 DIN In-Series:</b>				
Female To Female	(LP)	PE91029	B1	165
Female To Female		PE9409	C1	165
Female To Female	(B) (LP)	PE91038	D1	165
Female To Female	(B)	PE9414	A2	165
Male To Female	(LP)	PE91028	C6	164
Male To Female	90°	PE9410	A1	165
Male To Male	(LP)	PE91039	B6	164
Male To Male		PE9555	D6	164
T, Female-Female-Female		PE9556	C2	165
T, Female-Male-Female		PE9557	B2	165
<b>7/16 DIN Male To:</b>				
7mm	(P)	PE9509	C3	165
HN Female		PE9558	A3	165
N Female		PE9179	B1	160
N Female	(LP)	PE91031	A1	160
N Male		PE9535	B6	159
N Male	(LP)	PE91030	A6	159
SMA Female		PE9412	C5	150
SMA Female	(LP)	PE91036	B5	150
SMA Male	(LP)	PE91043	C4	150
TNC Female		PE9636	B5	163
TNC Male		PE9637	D4	163
<b>7mm To:</b>				
2.4mm Female	(P)	PE9459	A4	156
2.4mm Male	(P)	PE9458	D3	156
2.92mm Female	(P)	PE9461	C5	155
2.92mm Male	(P)	PE9460	B5	155
3.5mm Female	(P)	PE9325	C4	154
3.5mm Male	(P)	PE9326	B4	154
7/16 DIN Female	(P)	PE9510	D3	165
7/16 DIN Male	(P)	PE9509	C3	165
BNC Female	(P)	PE9220	A6	169
BNC Male	(P)	PE9221	D5	169
N Female	(P)	PE9216	A2	161
N Male	(P)	PE9217	D1	161
SMA Female	(P)	PE9214	D3	151
SMA Female	(PM) (P)	PE9327	A4	151
SMA Male	(P)	PE9215	C3	151
SSMA Female	(P)	PE9356	D4	157
SSMA Male	(P)	PE9355	C4	157
TNC Female	(P)	PE9218	C2	164
TNC Male	(P)	PE9219	B2	164
<b>75 Ohm BNC Female To:</b>				
75 Ohm N Female		PE9371	A4	176
75 Ohm N Male		PE9369	C3	176
75 Ohm TNC Male		PE9631	D5	176
F Female	(P)	PE9744	D5	177
F Male	(P)	PE9743	B5	177
Mini 75 Ohm SMB Jack		PE9619	B4	178
Mini 75 Ohm SMB Plug		PE9617	D3	178
<b>75 Ohm BNC In-Series:</b>				
Female To Female		PE9362	B5	178
Female To Female	(B)	PE9363	C5	178
Female To Female	(B) (I)	PE9366	D5	178
Female To Female	(PM)	PE9367	A6	178
Male To Female	90°	PE9361	A5	178
Male To Male		PE9364	D4	178
T, Female-Male-Female		PE9365	B6	178
<b>75 Ohm BNC Male To:</b>				
75 Ohm N Female		PE9368	D3	176
75 Ohm N Male		PE9370	B3	176
75 Ohm TNC Female		PE9630	A6	176
F Female	(P)	PE9741	C5	177
F Male	(P)	PE9742	A5	177
Mini 75 Ohm SMB Jack		PE9618	A4	178
Mini 75 Ohm SMB Plug		PE9616	C3	178
<b>75 Ohm N Female To:</b>				
75 Ohm BNC Female		PE9371	A4	176
75 Ohm BNC Male		PE9368	D3	176
75 Ohm SMB Jack		PE9583	A2	176
75 Ohm SMB Plug		PE9585	D1	176
75 Ohm SMC Jack		PE9587	C5	175
75 Ohm SMC Plug		PE9589	B5	175
75 Ohm TNC Female		PE9629	C4	175

Feature: (B) Bulkhead Mount / (H) Hermetically Sealed / (I) Isolated Sealed / (P) Precision / (PM) Panel Mount / (PO) Push On / (R) Radius Right Angle / (QD) Quick Disconnect (LP) Low PIM

See Our Website For Real-Time Stock Availability!

# Adapter Locator

Connector Type	Feature	Model No.	C/R	Page
75 Ohm TNC Male		PE9628	B4	175
F Female	(P)	PE9740	A1	176
F Male	(P)	PE9739	C6	175
F Male		PE9397	D6	175
Mini 75 Ohm SMB Jack		PE9615	A3	176
Mini 75 Ohm SMB Plug		PE9613	D2	176
N Male		PE9349	B4	162
<b>75 Ohm N In-Series:</b>				
Female To Female		PE9306	D2	175
Female To Female	(B) (H)	PE9416	A3	175
Female To Female	(B) (I)	PE9417	B3	175
Male To Female		PE9391	B2	175
Male To Female	90°	PE9307	C2	175
Male To Male		PE9308	A2	175
<b>75 Ohm N Male To:</b>				
75 Ohm BNC Female		PE9369	C3	176
75 Ohm BNC Male		PE9370	B3	176
75 Ohm SMB Jack		PE9582	C1	176
75 Ohm SMB Plug		PE9584	A1	176
75 Ohm SMC Jack		PE9586	B5	175
75 Ohm SMC Plug		PE9588	D4	175
75 Ohm TNC Female		PE9627	A4	175
75 Ohm TNC Male		PE9626	D3	175
F Female	(P)	PE9737	A6	175
F Female		PE9396	B6	175
F Male	(P)	PE9738	D5	175
Mini 75 Ohm SMB Jack		PE9614	C2	176
Mini 75 Ohm SMB Plug		PE9612	B2	176
N Female		PE9350	C4	162
<b>75 Ohm SMB In-Series:</b>				
Jack To Jack		PE9248	A1	178
Plug To Plug		PE9271	D6	177
T, Jack-Plug-Jack		PE9245	B1	178
<b>75 Ohm SMB Jack To:</b>				
75 Ohm N Female		PE9583	A2	176
75 Ohm N Male		PE9582	C1	176
BNC Female		PE9231	A4	173
BNC Male		PE9229	C3	173
Mini 75 Ohm SMB Plug		PE9735	A2	178
<b>75 Ohm SMB Plug To:</b>				
75 Ohm N Female		PE9585	D1	176
75 Ohm N Male		PE9584	B1	176
BNC Female		PE9232	D3	173
BNC Male		PE9230	B3	173
Mini 75 Ohm SMB Jack		PE9736	D1	178
<b>75 Ohm SMC In-Series:</b>				
Jack To Jack		PE9227	D6	176
Jack To Jack	(B)	PE9228	A1	177
Plug To Plug		PE9272	C6	176
T, Jack-Plug-Jack		PE9244	B1	177
<b>75 Ohm SMC Jack To:</b>				
75 Ohm N Female		PE9587	C5	175
75 Ohm N Male		PE9586	A5	175
BNC Female		PE9235	A2	173
BNC Male		PE9233	C1	173
<b>75 Ohm SMC Plug To:</b>				
75 Ohm N Female		PE9589	B5	175
75 Ohm N Male		PE9588	D4	175
BNC Female		PE9236	D1	173
BNC Male		PE9234	B1	173
<b>75 Ohm TNC Female To:</b>				
75 Ohm BNC Male		PE9630	A6	176
75 Ohm N Female		PE9629	C4	175
75 Ohm N Male		PE9627	A4	175
<b>75 Ohm TNC In-Series:</b>				
Female To Female		PE9622	D4	176
Female To Female	(B) (H)	PE9624	A5	176
Female To Female	(B) (I)	PE9625	B5	176
Male To Female	90°	PE9623	C4	176
<b>75 Ohm TNC Male To:</b>				
75 Ohm BNC Female		PE9631	D5	176
75 Ohm N Female		PE9628	B4	175
75 Ohm N Male		PE9626	D3	175
<b>Banana Plug To:</b>				
BNC Female (Double)		PE9008	C5	173
BNC Female (Single)		PE9175	D5	173
BNC Male (Double)		PE9009	D4	173

Connector Type	Feature	Model No.	C/R	Page
<b>Binding Post To:</b>				
BNC Female (Double)		PE9013	A6	173
BNC Male (Double)		PE9011	A5	173
BNC Male (Single)		PE9169	B5	173
<b>BNC Female (Double) To:</b>				
Banana Plug		PE9008	C5	173
Binding Post		PE9013	A6	173
<b>BNC Female (Single) To:</b>				
Banana Plug		PE9175	D5	173
<b>BNC Female To:</b>				
10-32 Female		PE9752	C1	168
10-32 Female	(B)	PE9754	D1	168
10-32 Male		PE9753	D6	167
10-32 Male	(B)	PE9755	A1	168
75 Ohm SMB Jack		PE9231	A4	173
75 Ohm SMB Plug		PE9232	D3	173
75 Ohm SMC Jack		PE9235	A2	173
75 Ohm SMC Plug		PE9236	D1	173
7mm	(P)	PE9220	A6	169
C Female		PE9537	D6	172
C Female	(B)	PE9204	A1	173
C Male		PE9087	C6	172
F Female		PE9153	A3	173
F Male		PE9151	D2	173
FME Jack		PE9712	C6	166
GR874		PE9222	C6	173
HN Male		PE9126	C3	169
MCX Jack		PE9466	C1	171
MCX Jack	(B)	PE9520	D1	171
MCX Plug		PE9467	A1	171
MHV Male		PE9297	D5	172
Mini UHF Male		PE9342	C4	166
MMCX Jack		PE9516	B5	170
MMCX Plug		PE9519	D4	170
N Female	(P)	PE9492	D1	162
N Female		PE9206	A2	162
N Female	(B)	PE9261	B2	162
N Female	(B)	PE9540	C2	162
N Female	(PM)	PE9238	D2	162
N Male	(P)	PE9491	D5	161
N Male		PE9002	A6	161
N Male	(PM)	PE9388	B6	161
N Male	90°	PE9278	C6	161
RCA Plug		PE9158	C4	173
Reverse Polarity BNC Male		PE9529	A5	172
SC Female		PE9571	C4	168
SC Male		PE9200	B4	168
SMA Female	(P)	PE9496	D6	152
SMA Female		PE9075	A1	153
SMA Female	(B)	PE9185	B1	153
SMA Female	(B)	PE9407	C1	153
SMA Male	(P)	PE9495	D5	152
SMA Male		PE9074	A6	152
SMB Jack		PE9136	C5	171
SMB Jack	(B)	PE9240	D5	171
SMB Plug		PE9137	D4	171
SMB Plug	(B)	PE9241	A5	171
SMC Jack		PE9140	A5	167
SMC Jack	(B)	PE9108	B5	167
SMC Plug		PE9141	C4	167
SSMA Male		PE9250	B5	157
SSMB Jack		PE9394	A1	172
SSMB Plug		PE9395	C6	171
TNC Female		PE9097	A5	164
TNC Female	(B) (H)	PE9483	B5	164
TNC Male		PE9088	B4	164
TNC Male	90°	PE9783	C4	164
UHF Female		PE9421	B1	166
UHF Male		PE9004	D6	165
<b>BNC In-Series:</b>				
Female To Female		PE9084	C2	172
Female To Female	(B) (H)	PE9093	D2	172
Female To Female	(B) (H)	PE9420	A3	172
Female To Female	(B) (I)	PE9172	B3	172
Female To Female	(PM)	PE9106	C3	172
Male To Female		PE9269	A2	172
Male To Female	90°	PE9085	B2	172
Male To Male		PE9000	C1	172
Male To Male	90°	PE9758	D1	172

Connector Type	Feature	Model No.	C/R	Page
T, Female-Female-Female		PE9003	C4	172
T, Female-Male-Female		PE9001	D3	172
T, Male-Female-Female		PE9174	A4	172
Y, Female-Male-Female		PE9484	B4	172
<b>BNC Male (Double) To:</b>				
Banana Plug		PE9009	D4	173
Binding Post		PE9011	A5	173
<b>BNC Male (Single) To:</b>				
Binding Post		PE9169	B5	173
<b>BNC Male To:</b>				
10-32 Female		PE9750	B1	168
10-32 Male		PE9751	C6	167
75 Ohm SMB Jack		PE9229	C3	173
75 Ohm SMB Plug		PE9230	B3	173
75 Ohm SMC Jack		PE9233	C1	173
75 Ohm SMC Plug		PE9234	B1	173
7mm	(P)	PE9221	D5	169
C Female		PE9109	B6	172
C Male		PE9536	A6	172
F Female		PE9150	C2	173
F Male		PE9152	B2	173
FME Jack		PE9711	B6	166
FME Plug		PE9697	D5	166
FME Plug	90°	PE9698	A6	166
GR874		PE9223	B6	173
HN Female		PE9129	D3	169
HN Male		PE9567	B3	169
MCX Jack		PE9468	B1	171
MCX Plug		PE9469	D6	170
MHV Female		PE9406	C5	172
Mini UHF Female		PE9341	D4	166
MMCX Jack		PE9518	A5	170
MMCX Plug		PE9517	C4	170
N Female	(P)	PE9490	D6	161
N Female		PE9005	A1	162
N Female	(PM)	PE9123	B1	162
N Female	90°	PE9566	C1	162
N Male	(P)	PE9489	A5	161
N Male		PE9127	B5	161
N Male	90°	PE9565	C5	161
RCA Jack		PE9171	B4	173
Reverse Polarity BNC Female		PE9530	D4	172
SC Male		PE9568	A4	168
SMA Female	(P)	PE9494	B6	152
SMA Female		PE9073	C6	152
SMA Male	(P)	PE9493	B5	152
SMA Male		PE9072	C5	152
SMB Jack		PE9132	B5	171
SMB Plug		PE9135	C4	171
SMC Jack		PE9138	D4	167
SMC Plug		PE9139	B4	167
SSMA Female		PE9191	C5	157
SSMA Male		PE9213	A5	157
SSMB Jack		PE9392	D6	171
SSMB Plug		PE9393	B6	171
TNC Female		PE9098	D4	164
TNC Male		PE9110	A4	164
UHF Female		PE9107	A1	166
UHF Male		PE9201	C6	165
<b>BNC Twinax In-Series:</b>				
Jack To Jack		PE9378	B4	179
Jack To Jack	(B)	PE9280	C4	179
Plug To Jack	90°	PE9377	A4	179
Plug To Plug		PE9376	D3	179
T, Jack-Jack-Jack		PE9279	A5	179
T, Jack-Plug-Jack		PE9375	D4	179
<b>C Female To:</b>				
BNC Female		PE9537	D6	172
BNC Female	(B)	PE9204	A1	173
BNC Male		PE9109	B6	172
GR874		PE9301	D6	174
HN Male		PE9296	C4	169
N Female		PE9539	A4	162
N Male		PE9124	B3	162
N Male	90°	PE9239	C3	162
TNC Male		PE9562	C5	164
<b>C In-Series:</b>				

Adapters

See Our Website For Real-Time Stock Availability!

Feature: (B) Bulkhead Mount / (H) Hermetically Sealed / (I) Isolated Sealed / (P) Precision / (PM) Panel Mount / (PO) Push On / (R) Radius Right Angle / (OD) Quick Disconnect (LP) Low PIM

 Free Freight Available via UPS Ground to USA & Canada	 Real-Time Stock Levels & Pricing On Our WebSite	 Toll-Free Technical Support (866) 727-8376	 Same-Day Shipping, Even Custom Cable Assemblies	141
---	---	--	---	-----

# Adapter Locator

Adapters

See Our Website For Real-Time Stock Availability!

Connector Type	Feature	Model No.	C/R	Page
Female To Female	(B)	PE9208	C5	174
Female To Female		PE9186	D5	174
Male To Female		PE9293	B5	174
Male To Male		PE9300	A5	174
T, Female-Female-Female		PE9294	B6	174
T, Female-Male-Female		PE9207	A6	174
<b>C Male To:</b>				
BNC Female		PE9087	C6	172
BNC Male		PE9536	A6	172
HN Female		PE9212	D4	169
HN Male		PE9579	B4	169
N Female		PE9295	D3	162
N Male		PE9538	A3	162
TNC Female		PE9564	D5	164
<b>D Sub Contact In-Series:</b>				
Plug To Plug		PE9688	A2	179
Plug To Receptacle		PE9687	B2	179
Receptacle To Receptacle		PE9689	C2	179
<b>D Sub Contact Plug To:</b>				
SMA Female		PE9422	B3	153
SMA Male		PE9425	C2	153
<b>D Sub Contact Receptacle To:</b>				
SMA Female		PE9423	C3	153
SMA Male		PE9424	D2	153
<b>F Female To:</b>				
75 Ohm BNC Female	(P)	PE9744	D5	177
75 Ohm BNC Male	(P)	PE9741	C5	177
75 Ohm N Female	(P)	PE9740	A1	176
75 Ohm N Male	(P)	PE9737	A6	175
75 Ohm N Male		PE9396	B6	175
BNC Female		PE9153	A3	173
BNC Male		PE9150	C2	173
N Male		PE9155	D4	162
PAL Jack		PE9634	D4	177
PAL Plug		PE9635	C4	177
RCA Jack		PE9168	B6	177
RCA Plug		PE9163	A6	177
SMA Female		PE91002	B2	153
SMA Male		PE91003	D1	153
UHF Female		PE9167	D1	166
UHF Male		PE9165	C1	166
<b>F In-Series:</b>				
Female To Female	(P)	PE9761	A3	177
Female To Female		PE9164	B3	177
Female To Female	(B)	PE9734	C3	177
Male To Female	(P)	PE9759	B2	177
Male To Female	(PO)	PE9160	C2	177
Male To Female	90°	PE9166	D2	177
Male To Male	(P)	PE9760	D1	177
Male To Male		PE9159	A2	177
<b>F Male To:</b>				
75 Ohm BNC Female	(P)	PE9743	B5	177
75 Ohm BNC Male	(P)	PE9742	A5	177
75 Ohm N Female	(P)	PE9739	C6	175
75 Ohm N Female		PE9397	D6	175
75 Ohm N Male	(P)	PE9738	D5	175
BNC Female		PE9151	D2	173
BNC Male		PE9152	B2	173
N Female		PE9389	A5	162
N Male		PE9632	B4	177
PAL Jack		PE9633	A4	177
PAL Plug		PE9633	A4	177
SMA Female		PE91001	A2	153
<b>FME In-Series:</b>				
Plug To Plug		PE9696	B5	166
<b>FME Jack To:</b>				
BNC Female		PE9712	C6	166
BNC Male		PE9711	B6	166
Mini UHF Female		PE9710	B4	166
Mini UHF Male		PE9709	A4	166
SMA Female		PE9708	B1	151
SMA Male		PE9707	D6	150
TNC Female		PE9714	C1	164
TNC Male		PE9713	B1	164
<b>FME Plug To:</b>				
BNC Male	90°	PE9697	D5	166
BNC Male		PE9698	A6	166
Mini UHF Male		PE9705	C3	166
Mini UHF Male	90°	PE9706	D3	166

Connector Type	Feature	Model No.	C/R	Page
N Male	90°	PE9704	C3	160
SMA Female		PE9703	A1	151
SMA Male		PE9702	C6	150
TNC Male		PE9699	D6	163
TNC Male		PE9700	A1	164
UHF Male		PE9701	B6	165
<b>GR874 In-Series:</b>				
GR874 To GR874	90°	PE9286	A3	179
T, GR874-GR874-GR874		PE9285	B3	179
<b>GR874 To:</b>				
BNC Female		PE9222	C6	173
BNC Male		PE9223	B6	173
C Female		PE9301	D6	174
HN Female		PE9387	B5	169
HN Male		PE9386	A5	169
N Female		PE9258	C5	162
N Male		PE9257	B5	162
SMA Female		PE9260	A4	153
SMA Male		PE9259	D3	153
<b>HN Female To:</b>				
7/16 DIN Male		PE9558	A3	165
BNC Male		PE9129	D3	169
C Male		PE9212	D4	169
GR874		PE9387	B5	169
LC Male		PE9181	A6	168
N Female		PE9360	B1	161
N Female	(PM)	PE9553	C1	161
N Male		PE9125	D6	160
SMA Female		PE9255	B3	151
SMA Male		PE9256	D2	151
<b>HN In-Series:</b>				
Female To Female	(B)	PE9580	D1	169
Female To Female		PE9193	A2	169
Male To Female		PE9576	B1	169
Male To Female	90°	PE9205	C1	169
Male To Male		PE9210	D6	168
Male To Male	90°	PE9577	A1	169
T, Female-Female-Female		PE9574	B3	169
T, Female-Male-Female		PE9575	D2	169
T, Male-Female-Male		PE9578	C2	169
<b>HN Male To:</b>				
7/16 DIN Female		PE9559	B3	165
BNC Female		PE9126	C3	169
BNC Male		PE9567	B3	169
C Female		PE9296	C4	169
C Male		PE9579	B4	169
GR874		PE9386	A5	169
LC Female		PE9413	B6	168
MHV Female		PE9264	A4	169
N Female		PE9194	A1	161
N Male		PE9554	C6	160
SMA Female		PE9253	A3	151
SMA Male		PE9254	C2	151
TNC Male		PE9563	A2	164
<b>LC Female To:</b>				
HN Male		PE9413	B6	168
N Female		PE9298	B6	160
N Male		PE9299	D5	160
<b>LC In-Series:</b>				
Female To Female	90°	PE9419	C5	168
Male To Female		PE9398	B5	168
Male To Male		PE9569	A5	168
<b>LC Male To:</b>				
HN Female		PE9181	A6	168
N Female		PE9237	A6	160
<b>MCX In-Series:</b>				
Jack To Jack	(B)	PE9524	A6	170
Jack To Jack		PE9474	B6	170
Plug To Jack		PE9479	D5	170
<b>MCX Jack To:</b>				
BNC Female	(B)	PE9466	C1	171
BNC Female		PE9520	D1	171
BNC Male		PE9468	B1	171
MMCX Jack		PE9526	B4	170
MMCX Plug		PE9525	D3	170
N Female		PE9462	D3	161
N Male		PE9464	B3	161
SMA Female		PE9470	B2	152

Connector Type	Feature	Model No.	C/R	Page
SMA Male	(B)	PE9472	D1	152
TNC Female		PE9544	C3	164
TNC Female		PE9521	D3	164
TNC Male		PE9542	A3	164
<b>MCX Plug To:</b>				
BNC Female		PE9467	A1	171
BNC Male		PE9469	D6	170
MMCX Jack		PE9528	A4	170
MMCX Plug		PE9527	C3	170
N Female		PE9463	C3	161
N Male		PE9465	A3	161
SMA Female		PE9471	A2	152
SMA Male		PE9473	C1	152
TNC Female		PE9545	B3	164
TNC Male		PE9543	D2	164
<b>MHV Female To:</b>				
BNC Male		PE9406	C5	172
HN Male		PE9264	A4	169
SHV Jack		PE9339	A3	174
SHV Plug		PE9265	D2	174
<b>MHV In-Series:</b>				
Female To Female	(B) (H)	PE9267	B1	174
Female To Female		PE9268	C1	174
Male To Female		PE9266	A1	174
T, Female-Male-Female		PE9211	D1	174
<b>MHV Male To:</b>				
BNC Female		PE9297	D5	172
SHV Jack		PE9335	C2	174
SHV Plug		PE9340	B2	174
<b>Mini 75 Ohm SMB In-Series:</b>				
Jack To Jack	(B)	PE9608	A3	178
Jack To Jack		PE9611	B3	178
Plug To Jack		PE9610	D2	178
Plug To Plug		PE9609	C2	178
<b>Mini 75 Ohm SMB Jack To:</b>				
75 Ohm BNC Female		PE9619	B4	178
75 Ohm BNC Male		PE9618	A4	178
75 Ohm N Female		PE9615	A3	176
75 Ohm N Male		PE9614	C2	176
75 Ohm SMB Plug		PE9736	D1	178
<b>Mini 75 Ohm SMB Plug To:</b>				
75 Ohm BNC Female		PE9617	D3	178
75 Ohm BNC Male		PE9616	C3	178
75 Ohm N Female		PE9613	D2	176
75 Ohm N Male		PE9612	B2	176
75 Ohm SMB Jack		PE9735	A2	178
<b>Mini SMP Female To:</b>				
2.92mm Female	(P)	PE9782	A6	155
<b>Mini SMP In-Series:</b>				
Female To Female		PE9780	A2	170
<b>Mini SMP Male To:</b>				
2.92mm Female	(P)	PE9781	D5	155
<b>Mini UHF Female To:</b>				
BNC Male		PE9341	D4	166
FME Jack		PE9710	B4	166
N Male		PE9064	A3	160
TNC Male		PE9345	B6	163
UHF Male		PE9348	D5	165
<b>Mini UHF In-Series:</b>				
Female To Female	90°	PE9343	C2	166
Male To Female		PE9347	B2	166
T, Female-Female-Female		PE9066	A3	166
T, Female-Male-Female		PE9065	D2	166
<b>Mini UHF Male To:</b>				
BNC Female	90°	PE9342	C4	166
FME Jack		PE9709	A4	166
FME Plug		PE9705	C3	166
FME Plug		PE9706	D3	166
N Female		PE9183	B3	160
TNC Female		PE9346	C6	163
UHF Female	PE9344	A6	165	
<b>MMCX In-Series:</b>				
Jack To Jack	(B)	PE9523	D2	170
Jack To Jack		PE9522	A3	170
Plug To Jack		PE9480	C2	170
<b>MMCX Jack To:</b>				
BNC Female		PE9516	B5	170

Feature: (B) Bulkhead Mount / (H) Hermetically Sealed / (I) Isolated Sealed / (P) Precision / (PM) Panel Mount / (PO) Push On / (R) Radius Right Angle / (QD) Quick Disconnect (LP) Low PIM



# Adapter Locator

Connector Type	Feature	Model No.	C/R	Page	Connector Type	Feature	Model No.	C/R	Page	Connector Type	Feature	Model No.	C/R	Page
BNC Male		PE9518	A5	170	TNC Male	(P)	PE9447	C3	159	SC Male		PE9570	D4	160
MCX Jack		PE9526	B4	170	TNC Male		PE9089	D3	159	SMA Female	(P)	PE9430	D6	148
MCX Plug		PE9528	A4	170	TNC Male	90°	PE9263	A4	159	SMA Female	(P) (PM)	PE9498	A1	149
SMA Female		PE9477	B1	152	UHF Female		PE9385	D2	160	SMA Female		PE9081	B1	149
SMA Male		PE9478	D6	151	UHF Male		PE9112	C2	160	SMA Female	(QD)	PE9684	C1	149
<b>MMCX Plug To:</b>					<b>N In-Series:</b>									
BNC Female		PE9519	D4	170	Cross, Female-		PE9548	D6	158	SMA Female	(B)	PE9551	D1	149
BNC Male		PE9517	C4	170	Female-					SMA Female	(PM)	PE9275	A2	149
MCX Jack		PE9525	D3	170	Female-Female					SMA Male	(P)	PE9431	C4	148
MCX Plug		PE9527	C3	170	Cross, Female-					SMA Male	(PM) (P)	PE9499	D4	148
SMA Female		PE9475	A1	152	Female-		PE9549	C6	158	SMA Male		PE9080	A5	148
SMA Male		PE9476	C6	151	Female-Male					SMB Jack		PE9313	B4	161
<b>N Female To:</b>														
1.85mm Female	(P)	PE9721	B1	157	Female To Female	(P)	PE9428	D2	158	SMB Plug		PE9314	A4	161
1.85mm Male	(P)	PE9719	D6	156	Female To Female	(LP)	PE91035	A3	158	SMC Jack		PE9317	A4	160
2.4mm Female	(P)	PE9502	C3	156	Female To Female	(B) (P)	PE9500	B3	158	SMC Plug		PE9318	D3	160
2.4mm Male	(P)	PE9501	A3	156	Female To Female	(PM) (P)	PE9429	C3	158	SSMA Female		PE9352	A4	157
2.92mm Female	(P)	PE9664	A5	155	Female To Female	(B) (H)	PE9006	D3	158	SSMA Male		PE9351	C3	157
2.92mm Male	(P)	PE9662	C4	155	Female To Female	(B) (H)	PE9128	A4	158	TNC Female	(P)	PE9448	D2	159
3.5mm Female	(P)	PE9323	A4	154	Female To Female	(B) (H)	PE9383	B4	158	TNC Female	90°	PE9090	A3	159
3.5mm Male	(P)	PE9324	C3	154	Female To Female	(B) (I)	PE9382	C4	158	TNC Male	(P)	PE9550	B3	159
7/16 DIN Female	(LP)	PE91033	C1	160	Female To Female	(PM)	PE9173	D4	158	TNC Male		PE9446	B2	159
7/16 DIN Female		PE9180	D1	160	Female To Female	90°	PE9359	A5	158	TNC Male		PE9130	C2	159
7/16 DIN Male	(LP)	PE91031	A1	160	Female To Female	(B) 90°	PE9541	B5	158	UHF Female		PE9111	B2	160
7/16 DIN Male		PE9179	B1	160	Male To Female	(P)	PE9426	A1	158	UHF Male		PE9113	A2	160
75 Ohm N Male		PE9350	C4	162	Male To Female	(LP)	PE91040	B1	158	<b>PAL In-Series:</b>				
7mm		PE9216	A2	161	Male To Female	(QD)	PE9311	C1	158	Jack To Jack		PE9681	C1	175
BNC Female	(P)	PE9492	D1	162	Male To Female	(B)	PE9547	D1	158	Plug To Plug		PE9680	B1	175
BNC Female		PE9206	A2	162	Male To Female	(R) (P)	PE9595	A2	158	<b>PAL Jack To:</b>				
BNC Female	(B)	PE9261	B2	162	Male To Female	90°	PE9515	B2	158	F Female		PE9634	D4	177
BNC Female	(B)	PE9540	C2	162	Male To Female	(P)	PE9086	C2	158	F Male		PE9632	B4	177
BNC Female	(PM)	PE9238	D2	162	Male To Male	(LP)	PE91034	B6	157	<b>PAL Plug To:</b>				
BNC Male	(P)	PE9490	D6	161	Male To Male	90°	PE9007	C6	157	F Female		PE9635	C4	177
BNC Male		PE9005	A1	162	Male To Male		PE9198	D6	157	F Male		PE9633	A4	177
BNC Male	(PM)	PE9123	B1	162	T, Female-Female-		PE9101	B6	158	<b>QMA Female To:</b>				
BNC Male	90°	PE9566	C1	162	Female		PE9102	D5	158	N Male		PE9787	B2	161
C Female		PE9539	A4	162	T, Female-Male-					<b>QMA Male To:</b>				
C Male		PE9295	D3	162	Female		PE9481	A6	158	SMA Female		PE9786	B4	151
F Male		PE9389	A5	162	T, Male-Female-		PE9390	C5	158	<b>QN Female To:</b>				
GR874		PE9258	C5	162	Female		<b>N Male To:</b>							
HN Female		PE9360	B1	161	1.85mm Female	(P)	PE9720	A1	157	1.85mm Female	(P)	PE9720	A1	157
HN Female	(PM)	PE9553	C1	161	1.85mm Male	(P)	PE9718	C6	156	1.85mm Male	(P)	PE9718	C6	156
HN Male		PE9194	A1	161	2.4mm Female	(P)	PE9503	B3	156	2.4mm Female	(P)	PE9503	B3	156
LC Female		PE9298	B6	160	2.4mm Male	(P)	PE9504	D2	156	2.4mm Male	(P)	PE9504	D2	156
LC Male		PE9237	A6	160	2.92mm Female	(P)	PE9663	D4	155	2.92mm Female	(P)	PE9663	D4	155
MCX Jack		PE9462	D3	161	2.92mm Male	(P)	PE9661	B4	155	2.92mm Male	(P)	PE9661	B4	155
MCX Plug		PE9463	C3	161	3.5mm Female	(P)	PE9321	D3	154	3.5mm Female	(P)	PE9321	D3	154
Mini UHF Male		PE9183	B3	160	3.5mm Male	(P)	PE9322	B3	154	3.5mm Male	(P)	PE9322	B3	154
QN Male		PE9788	D2	161	7/16 DIN Female	(LP)	PE91032	C6	159	7/16 DIN Female	(LP)	PE91032	C6	159
Reverse Polarity N Male		PE9770	D1	159	7/16 DIN Female		PE9178	D6	159	7/16 DIN Female		PE9178	D6	159
Reverse Polarity SMA Male		PE9732	B4	149	7/16 DIN Male	(LP)	PE91030	A6	159	7/16 DIN Male	(LP)	PE91030	A6	159
Reverse Polarity TNC Male		PE9731	D5	159	7/16 DIN Male		PE9535	B6	159	7/16 DIN Male		PE9535	B6	159
SC Female		PE9292	C5	160	75 Ohm N Female	(P)	PE9349	B4	162	75 Ohm N Female	(P)	PE9349	B4	162
SC Male		PE9277	B5	160	7mm	(P)	PE9217	D1	161	7mm	(P)	PE9217	D1	161
SMA Female	(P)	PE9432	B2	149	BNC Female	(P)	PE9491	D5	161	BNC Female	(P)	PE9491	D5	161
SMA Female	(B) (P)	PE9486	C2	149	BNC Female		PE9002	A6	161	BNC Female	(PM)	PE9002	A6	161
SMA Female	(PM) (P)	PE9434	D2	149	BNC Female	90°	PE9388	B6	161	BNC Female	90°	PE9388	B6	161
SMA Female		PE9083	A3	149	BNC Male	(P)	PE9278	C6	161	BNC Male	(P)	PE9489	A5	161
SMA Female	(B)	PE9408	C3	149	BNC Male		PE9127	B5	161	BNC Male	90°	PE9127	B5	161
SMA Female	(B) (P)	PE9435	D3	149	BNC Male		PE9565	C5	161	BNC Male	90°	PE9565	C5	161
SMA Female	(B)	PE9252	B3	149	C Female		PE9124	B3	162	C Female		PE9124	B3	162
SMA Female	(PM)	PE9104	A4	149	C Female	90°	PE9239	C3	162	C Female	90°	PE9239	C3	162
SMA Male	(P)	PE9433	B5	148	C Male		PE9538	A3	162	C Male		PE9538	A3	162
SMA Male	(B) (P)	PE9487	C5	148	F Female		PE9155	D4	162	F Female		PE9155	D4	162
SMA Male	(B) (P)	PE9488	D5	148	FME Plug		PE9704	C3	160	FME Plug		PE9704	C3	160
SMA Male	(PM) (P)	PE9497	A6	148	GR874		PE9257	B5	162	GR874		PE9257	B5	162
SMA Male		PE9082	B6	148	HN Female		PE9125	D6	160	HN Female		PE9125	D6	160
SMA Male	(PM)	PE9105	C6	148	HN Male		PE9554	C6	160	HN Male		PE9554	C6	160
SMB Jack		PE9315	D4	161	LC Female		PE9299	D5	160	LC Female		PE9299	D5	160
SMB Plug		PE9316	C4	161	MCX Jack		PE9464	B3	161	MCX Jack		PE9464	B3	161
SMC Jack		PE9319	C4	160	MCX Plug		PE9465	A3	161	MCX Plug		PE9465	A3	161
SMC Plug		PE9320	B4	160	Mini UHF Female		PE9064	A3	160	Mini UHF Female		PE9064	A3	160
SSMA Female		PE9354	B4	157	QMA Female		PE9787	B2	161	QMA Female		PE9787	B2	161
SSMA Male		PE9353	D3	157	QN Female		PE9789	C2	161	QN Female		PE9789	C2	161
TNC Female	(P)	PE9449	B4	159	Reverse Polarity N Female		PE9771	C1	159	Reverse Polarity N Female		PE9771	C1	159
TNC Female	(PM) (P)	PE9450	C4	159	Reverse Polarity SMA Female		PE9733	C4	149	Reverse Polarity SMA Female		PE9733	C4	149
TNC Female		PE9131	D4	159	Reverse Polarity TNC Female		PE9730	C5	159	Reverse Polarity TNC Female		PE9730	C5	159
TNC Female	(B)	PE9482	A5	159	SC Female		PE9196	A5	160	SC Female		PE9196	A5	160
TNC Female	(PM)	PE9552	B5	159										

Adapters

See Our Website For Real-Time Stock Availability!

Feature: (B) Bulkhead Mount / (H) Hermetically Sealed / (I) Isolated Sealed / (P) Precision / (PM) Panel Mount / (PO) Push On / (R) Radius Right Angle / (QD) Quick Disconnect (LP) Low PIM

 <b>Free Freight Available</b> via UPS Ground to USA & Canada	 <b>Real-Time Stock</b> Levels & Pricing On Our Website	 <b>Toll-Free Technical</b> Support (866) 727-8376	 <b>Same-Day Shipping,</b> Even Custom Cable Assemblies	143
--	--	---	--	-----

# Adapter Locator

Adapters

See Our Website For Real-Time Stock Availability!

Connector Type	Feature	Model No.	C/R	Page
Reverse Polarity TNC Male		PE9605	C3	150
SMA Female		PE9533	C5	147
TNC Female		PE9596	D2	150
TNC Male		PE9597	C2	150
<b>Reverse Polarity TNC Female To:</b>				
N Male		PE9730	C5	159
Reverse Polarity SMA Female		PE9606	B4	150
Reverse Polarity SMA Male		PE9604	D3	150
SMA Female		PE9603	B2	150
SMA Male		PE9600	D1	150
TNC Male		PE9532	A4	163
<b>Reverse Polarity TNC In-Series:</b>				
Male To Female	90° (P)	PE9918	D3	163
<b>Reverse Polarity TNC Male To:</b>				
N Female		PE9731	D5	159
Reverse Polarity SMA Female		PE9607	A4	150
Reverse Polarity SMA Male		PE9605	C3	150
SMA Female		PE9602	A2	150
SMA Male		PE9601	C1	150
TNC Female		PE9531	B4	163
<b>Reverse Thread SMA Female To:</b>				
SMA Male		PE9682	D5	147
<b>Reverse Thread SMA Male To:</b>				
SMA Female		PE9683	A6	147
<b>SC Female To:</b>				
BNC Female		PE9571	C4	168
N Female		PE9292	C5	160
N Male		PE9196	A5	160
<b>SC In-Series:</b>				
Female To Female		PE9404	A3	168
Female To Female	(B)	PE9573	B3	168
Male To Female		PE9572	C2	168
Male To Female	90°	PE9405	D2	168
Male To Male		PE9403	B2	168
T, Female-Male-Female		PE9225	C3	168
<b>SC Male To:</b>				
BNC Female		PE9200	B4	168
BNC Male		PE9568	A4	168
N Female		PE9277	B5	160
N Male		PE9570	D4	160
<b>SHV In-Series:</b>				
Jack To Jack		PE9337	A4	174
Jack To Jack	(B) (H)	PE9336	B4	174
Plug To Jack		PE9749	C3	174
Plug To Jack	90°	PE9338	D3	174
T, Jack-Plug-Jack		PE9249	C4	174
<b>SHV Jack To:</b>				
MHV Female		PE9339	A3	174
MHV Male		PE9335	C2	174
<b>SHV Plug To:</b>				
MHV Female		PE9265	D2	174
MHV Male		PE9340	B2	174
<b>SMA Female To:</b>				
1.0/2.3 Slide On Jack		PE9693	A5	152
1.0/2.3 Slide On Plug		PE9691	D4	152
1.85mm Female	(P)	PE9729	B3	148
1.85mm Male	(P)	PE9726	A3	148
2.4mm Female	(P)	PE9656	B2	148
2.4mm Male	(P)	PE9655	A2	148
3.5mm Female	(P)	PE9725	B1	148
3.5mm Male	(P)	PE9724	A1	148
7/16 DIN Female	(LP)	PE91042	D5	150
7/16 DIN Male	(LP)	PE91036	B5	150
7/16 DIN Male		PE9412	C5	150
7mm	(P)	PE9214	D3	151
7mm	(PM) (P)	PE9327	A4	151
BNC Female	(P)	PE9496	D6	152
BNC Female		PE9075	A1	153
BNC Female	(B)	PE9185	B1	153
BNC Female	(B)	PE9407	C1	153
BNC Male	(P)	PE9494	B6	152
BNC Male		PE9073	C6	152
D Sub Contact Plug		PE9422	B3	153
D Sub Contact Receptacle		PE9423	C3	153
F Female		PE91002	B2	153

Connector Type	Feature	Model No.	C/R	Page
F Male		PE91001	A2	153
FME Jack		PE9708	B1	151
FME Plug		PE9703	A1	151
GR874		PE9260	A4	153
HN Female		PE9255	B3	151
HN Male		PE9253	A3	151
MCX Jack		PE9470	B2	152
MCX Plug		PE9471	A2	152
MMCX Jack		PE9477	B1	152
MMCX Plug		PE9475	A1	152
N Female	(B)	PE9252	B3	149
N Female	(PM)	PE9104	A4	149
N Female	(P)	PE9432	B2	149
N Female	(B) (P)	PE9486	C2	149
N Female	(PM) (P)	PE9434	D2	149
N Female		PE9083	A3	149
N Female	(B)	PE9408	C3	149
N Female	(B) (P)	PE9435	D3	149
N Male	(P)	PE9430	D6	148
N Male	(P) (PM)	PE9498	A1	149
N Male		PE9081	B1	149
N Male	(QD)	PE9684	C1	149
N Male	(B)	PE9551	D1	149
N Male	(PM)	PE9275	A2	149
QMA Male		PE9786	B4	151
Reverse Polarity SMA Male		PE9533	C5	147
Reverse Polarity TNC Female		PE9603	B2	150
Reverse Polarity TNC Male		PE9602	A2	150
Reverse Thread SMA Male		PE9683	A6	147
SMB Jack		PE9143	C3	152
SMB Plug		PE9142	B3	152
SMC Jack		PE9147	B2	151
SMC Plug		PE9146	A2	151
SMP Female	(P)	PE9779	C5	151
SMP Male	(P)	PE9512	A5	151
SMP Male	(P)	PE9778	B5	151
SSMA Female		PE9399	B4	148
SSMA Male		PE9188	A4	148
SSMB Plug		PE9402	A4	152
TNC Female	(P)	PE9442	C6	149
TNC Female		PE9079	D6	149
TNC Female	(B)	PE9251	A1	150
TNC Female	(PM)	PE9276	B1	150
TNC Male	(P)	PE9440	A6	149
TNC Male	(P)	PE9077	B6	149
UHF Male		PE9415	B6	150
UMCX Jack		PE91006	B6	151
UMCX Plug		PE91005	A6	151
<b>SMA In-Series:</b>				
Female To Female	(P)	PE9507	C5	146
Female To Female	(P)	PE9695	D5	146
Female To Female	(B) (P)	PE9508	A6	146
Female To Female	(P) (PM)	PE9670	B6	146
Female To Female		PE9070	C6	146
Female To Female		PE9380	D6	146
Female To Female	(B)	PE9071	A1	147
Female To Female	(B)	PE9620	B1	147
Female To Female	(B) (H)	PE9184	C1	147
Female To Female	(B) (I)	PE9067	D1	147
Female To Female	(PM)	PE9312	A2	147
Female To Female	(R)	PE9274	B2	147
Female To Female	90°	PE9485	D2	147
Female To Female	90° (P)	PE9643	C2	147
Female-Female-Female		PE9246	D3	147
Female-Male-Female		PE9182	C3	147
Male To Female	(P)	PE9506	D2	146
Male To Female	(P)	PE9694	A3	146
Male To Female	(P) (QD)	PE9774	B3	146
Male To Female	(PM) (P)	PE9671	C3	146
Male To Female		PE9103	D3	146
Male To Female	(QD)	PE9546	A4	146
Male To Female	(B)	PE9621	B4	146
Male To Female	(R)	PE9262	C4	146
Male To Female	90° (P)	PE9641	D4	146
Male To Female	45°	PE9381	B5	146
Male To Female	90°	PE9068	A5	146
Male To Male	(P)	PE9505	B1	146
Male To Male	(P) (PM)	PE9669	C1	146

Connector Type	Feature	Model No.	C/R	Page
Male To Male		PE9069	D1	146
Male To Male	(R)	PE9273	A2	146
Male To Male	90° (P)	PE9642	B2	146
Male To Male		PE9418	C2	146
Male-Female-Male		PE9247	B3	147
Male-Male-Male		PE9379	A3	147
<b>SMA Male To:</b>				
1.0/2.3 Slide On Jack		PE9690	C4	152
1.0/2.3 Slide On Plug		PE9692	B4	152
1.85mm Female	(P)	PE9728	D2	148
1.85mm Male	(P)	PE9727	C2	148
2.4mm Female	(P)	PE9654	D1	148
2.4mm Male	(P)	PE9653	C1	148
3.5mm Female	(P)	PE9723	D6	147
3.5mm Male	(P)	PE9722	C6	147
7/16 DIN Female	(LP)	PE91041	D4	150
7/16 DIN Female		PE9411	A5	150
7/16 DIN Male	(LP)	PE91043	C4	150
7mm	(P)	PE9215	C3	151
BNC Female	(P)	PE9495	D5	152
BNC Female		PE9074	A6	152
BNC Male	(P)	PE9493	B5	152
BNC Male		PE9072	C5	152
D Sub Contact Plug		PE9425	C2	153
D Sub Contact Receptacle		PE9424	D2	153
F Female		PE91003	D1	153
FME Jack		PE9707	D6	150
FME Plug		PE9702	C6	150
GR874		PE9259	D3	153
HN Female		PE9256	D2	151
HN Male		PE9254	C2	151
MCX Jack		PE9472	D1	152
MCX Plug		PE9473	C1	152
MMCX Jack		PE9478	D6	151
MMCX Plug		PE9476	C6	151
N Female	(PM)	PE9105	C6	148
N Female	(P)	PE9433	B5	148
N Female	(B) (P)	PE9487	C5	148
N Female	(B) (P)	PE9488	D5	148
N Female	(PM) (P)	PE9497	A6	148
N Female		PE9082	B6	148
N Male	(P)	PE9431	C4	148
N Male	(PM) (P)	PE9499	D4	148
N Male		PE9080	A5	148
Reverse Polarity MCX Plug		PE9581	C2	152
Reverse Polarity SMA Female		PE9534	B5	147
Reverse Polarity TNC Female		PE9600	D1	150
Reverse Polarity TNC Male		PE9601	C1	150
Reverse Thread SMA Female		PE9682	D5	147
SMB Jack		PE9145	A3	152
SMB Plug		PE9144	D2	152
SMC Jack		PE9149	D1	151
SMC Plug		PE9148	C1	151
SMP Female	(P)	PE9513	D4	151
SMP Male	(P)	PE9511	C4	151
SSMA Female		PE9063	D3	148
SSMA Male		PE9187	C3	148
SSMB Jack		PE9401	D3	152
TNC Female	(P)	PE9441	B5	149
TNC Female		PE9078	C5	149
TNC Female	(PM)	PE9384	D5	149
TNC Male	(P)	PE9439	D4	149
TNC Male		PE9076	A5	149
UHF Female		PE9400	A6	150
UMCX Jack		PE91007	D5	151
<b>SMB In-Series:</b>				
Jack To Jack		PE9116	D2	171
Jack To Jack	(B)	PE9122	A3	171
Plug To Jack		PE9120	C2	171
Plug To Plug		PE9118	B2	171
T, Jack-Jack-Jack		PE9302	A4	171
T, Jack-Plug-Jack		PE9243	C3	171
T, Plug-Jack-Jack		PE9309	D3	171
T, Plug-Plug-Plug		PE9310	B3	171
<b>SMB Jack To:</b>				
BNC Female		PE9136	C5	171
BNC Female	(B)	PE9240	D5	171

Feature: (B) Bulkhead Mount / (H) Hermetically Sealed / (I) Isolated Sealed / (P) Precision / (PM) Panel Mount / (PO) Push On / (R) Radius Right Angle / (QD) Quick Disconnect (LP) Low PIM



# Adapter Locator

Connector Type	Feature	Model No.	C/R	Page
BNC Male		PE9132	B5	171
N Female		PE9315	D4	161
N Male		PE9313	B4	161
SMA Female		PE9143	C3	152
SMA Male		PE9145	A3	152
SMC Jack		PE9283	A4	167
SMC Plug		PE9284	C3	167
<b>SMB Plug To:</b>				
BNC Female		PE9137	D4	171
BNC Female	(B)	PE9241	A5	171
BNC Male		PE9135	C4	171
N Female		PE9316	C4	161
N Male		PE9314	A4	161
SMA Female		PE9142	B3	152
SMA Male		PE9144	D2	152
SMC Jack		PE9282	D3	167
SMC Plug		PE9281	B3	167
<b>SMC In-Series:</b>				
Jack To Jack		PE9115	D1	167
Jack To Jack	(B)	PE9121	A2	167
Plug To Jack		PE9119	B1	167
Plug To Jack	90°	PE9303	C1	167
Plug To Plug		PE9117	A1	167
T, Jack-Jack-Jack		PE9304	D2	167
T, Jack-Plug-Jack		PE9242	C2	167
T, Plug-Plug-Plug		PE9305	B2	167
<b>SMC Jack To:</b>				
BNC Female		PE9140	A5	167
BNC Female	(B)	PE9108	B5	167
BNC Male		PE9138	D4	167
N Female		PE9319	C4	160
N Male		PE9317	A4	160
SMA Female		PE9147	B2	151
SMA Male		PE9149	D1	151
SMB Jack		PE9283	A4	167
SMB Plug		PE9282	D3	167
TNC Male		PE9226	D1	164
<b>SMC Plug To:</b>				
BNC Female		PE9141	C4	167
BNC Male		PE9139	B4	167
N Female		PE9320	B4	160
N Male		PE9318	D3	160
SMA Female		PE9146	A2	151
SMA Male		PE9148	C1	151
SMB Jack		PE9284	C3	167
SMB Plug		PE9281	B3	167
<b>SMP Female To:</b>				
SMA Female	(P)	PE9779	C5	151
SMA Male	(P)	PE9513	D4	151
<b>SMP In-Series:</b>				
Female To Female		PE9686	D6	169
Female To Female		PE9776	B1	170
Female To Female		PE9775	A1	170
Female To Female				
Female To Female		PE91004	C6	169
Female To Female		PE9777	C1	170
<b>SMP Male To:</b>				
SMA Female	(P)	PE9512	A5	151
SMA Female	(P)	PE9778	B5	151
SMA Male	(P)	PE9511	C4	151
<b>SSMA Female To:</b>				
1.85mm Female	(P)	PE9765	B6	156
1.85mm Male	(P)	PE9762	D5	156
2.92mm Female	(P)	PE9769	A4	155
2.92mm Male	(P)	PE9766	C3	155
7mm	(P)	PE9356	D4	157
BNC Male		PE9191	C5	157
N Female		PE9354	B4	157
N Male		PE9352	A4	157
SMA Female		PE9399	B4	148
SMA Male		PE9063	D3	148
<b>SSMA In-Series:</b>				
Female To Female		PE9192	D2	157
Female To Female	(B)	PE9189	A3	157
Male To Female		PE9358	A2	157
Male To Female	(QD)	PE9685	B2	157
Male To Female	90°	PE9334	C2	157
Male To Male		PE9357	D1	157

Connector Type	Feature	Model No.	C/R	Page
<b>SSMA Male To:</b>				
1.85mm Female	(P)	PE9764	A6	156
1.85mm Male	(P)	PE9763	C5	156
2.92mm Female	(P)	PE9768	D3	155
2.92mm Male	(P)	PE9767	B3	155
7mm	(P)	PE9355	C4	157
BNC Female		PE9250	B5	157
BNC Male		PE9213	A5	157
N Female		PE9353	D3	157
N Male		PE9351	C3	157
SMA Female		PE9188	A4	148
SMA Male		PE9187	C3	148
<b>SSMB Jack To:</b>				
BNC Female		PE9394	A1	172
BNC Male		PE9392	D6	171
SMA Male		PE9401	D3	152
<b>SSMB Plug To:</b>				
BNC Female		PE9395	C6	171
BNC Male		PE9393	B6	171
SMA Female		PE9402	A4	152
<b>TNC Female To:</b>				
7/16 DIN Female		PE9639	C5	163
7/16 DIN Male		PE9636	B5	163
7mm	(P)	PE9218	C2	164
BNC Female		PE9097	A5	164
BNC Female	(B) (H)	PE9483	B5	164
BNC Male		PE9098	D4	164
C Male		PE9564	D5	164
FME Jack		PE9714	C1	164
MCX Jack		PE9544	C3	164
MCX Jack	(B)	PE9521	D3	164
MCX Plug		PE9545	B3	164
Mini UHF Male		PE9346	C6	163
N Female	(P)	PE9449	B4	159
N Female	(PM) (P)	PE9450	C4	159
N Female		PE9131	D4	159
N Female	(B)	PE9482	A5	159
N Female	(PM)	PE9552	B5	159
N Female	(P)	PE9448	D2	159
N Male		PE9090	A3	159
N Male	90°	PE9550	B3	159
N Male		PE9599	B3	150
Reverse Polarity SMA Female		PE9596	D2	150
Reverse Polarity SMA Male		PE9531	B4	163
Reverse Polarity TNC Male		PE9442	C6	149
SMA Female	(P)	PE9079	D6	149
SMA Female	(B)	PE9251	A1	150
SMA Female	(PM)	PE9276	B1	150
SMA Male	(P)	PE9441	B5	149
SMA Male		PE9078	C5	149
SMA Male	(PM)	PE9384	D5	149
UHF Male		PE9372	A6	163
<b>TNC In-Series:</b>				
Female To Female	(P)	PE9444	D1	163
Female To Female		PE9099	A2	163
Female To Female	(B) (H)	PE9154	B2	163
Female To Female	(B) (I)	PE9287	C2	163
Female To Female	(PM)	PE9288	D2	163
Female To Female	(P)	PE9443	D6	162
Male To Female	(QD)	PE9561	A1	163
Male To Female	90°	PE9100	B1	163
Male To Female		PE9270	C1	163
Male To Male	(P)	PE9445	A6	162
Male To Male		PE9091	B6	162
Male To Male	90°	PE9560	C6	162
T, Female-Female-Female		PE9289	C3	163
T, Female-Male-Female		PE9195	A3	163
T, Male-Female-Female		PE9290	B3	163
<b>TNC Male To:</b>				
BNC Female	90°	PE9783	C4	164
7/16 DIN Female		PE9638	A5	163
7/16 DIN Male		PE9637	D4	163
7mm	(P)	PE9219	B2	164
BNC Female		PE9088	B4	164
BNC Male		PE9110	A4	164
C Female		PE9562	C5	164

Connector Type	Feature	Model No.	C/R	Page
FME Jack		PE9713	B1	164
FME Plug		PE9699	D6	163
FME Plug	90°	PE9700	A1	164
HN Male		PE9563	A2	164
MCX Jack		PE9542	A3	164
MCX Plug		PE9543	D2	164
Mini UHF Female		PE9345	B6	163
N Female	(P)	PE9447	C3	159
N Female		PE9089	D3	159
N Female	90°	PE9263	A4	159
N Male	(P)	PE9446	B2	159
N Male		PE9130	C2	159
Reverse Polarity SMA Female		PE9598	A3	150
Reverse Polarity SMA Male		PE9597	C2	150
Reverse Polarity TNC Female		PE9532	A4	163
SMA Female	(P)	PE9440	A6	149
SMA Female		PE9077	B6	149
SMA Male	(P)	PE9439	D4	149
SMA Male		PE9076	A5	149
SMC Jack		PE9226	D1	164
UHF Female		PE9291	D5	163
<b>UHF Female To:</b>				
BNC Female		PE9421	B1	166
BNC Male		PE9107	A1	166
F Female		PE9167	D1	166
Mini UHF Male		PE9344	A6	165
N Female		PE9385	D2	160
N Male		PE9111	B2	160
SMA Male		PE9400	A6	150
TNC Male		PE9291	D5	163
<b>UHF In-Series:</b>				
Female To Female		PE9094	D4	165
Female To Female	(B)	PE9114	A5	165
Male To Female	90°	PE9209	C4	165
Male To Male		PE9096	B4	165
T, Female-Male-Female		PE9095	B5	165
<b>UHF Male To:</b>				
BNC Female		PE9004	D6	165
BNC Male		PE9201	C6	165
F Female		PE9165	C1	166
FME Plug		PE9701	B6	165
Mini UHF Female		PE9348	D5	165
N Female		PE9112	C2	160
N Male		PE9113	A2	160
SMA Female		PE9415	B6	150
TNC Female		PE9372	A6	163
<b>UMCX Jack To:</b>				
SMA Female		PE91006	B6	151
SMA Male		PE91007	D5	151
<b>UMCX Plug To:</b>				
SMA Female		PE91005	A6	151

**In 1941, the term RADAR was coined by the United States Navy as an acronym for Radio Detection And Ranging.**

Adapters

See Our Website For Real-Time Stock Availability!

Feature: (B) Bulkhead Mount / (H) Hermetically Sealed / (I) Isolated Sealed / (P) Precision / (PM) Panel Mount / (PO) Push On / (R) Radius Right Angle / (QD) Quick Disconnect / (LP) Low PIM

 <p>Free Freight Available via UPS Ground to USA &amp; Canada</p>	 <p>Real-Time Stock Levels &amp; Pricing On Our WebSite</p>	 <p>Toil-Free Technical Support (866) 727-8376</p>	 <p>Same-Day Shipping, Even Custom Cable Assemblies</p>
--	--	---	--

# ADAPTERS

See Adapter Locator on Pages 140-145 or the Adapter Matrix on Pages 138-139

See Page 246 for Mounting Holes

Adapters

See Our Website For Real-Time Stock Availability!

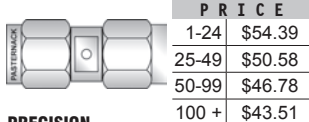
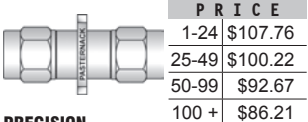
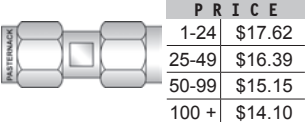
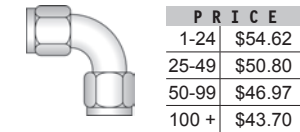
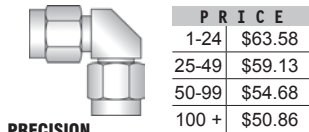
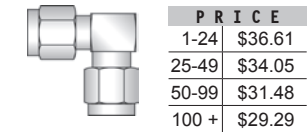
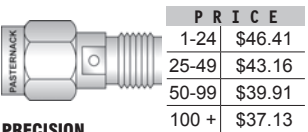
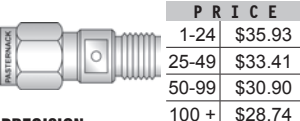
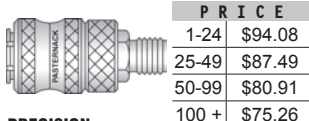
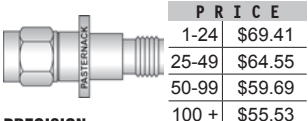
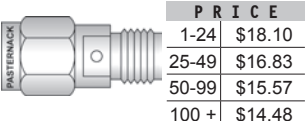
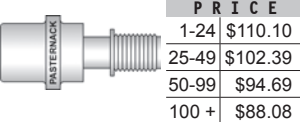
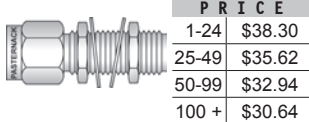
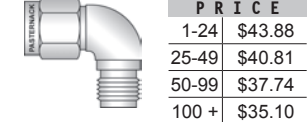
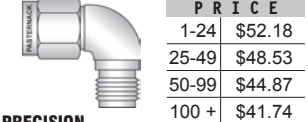
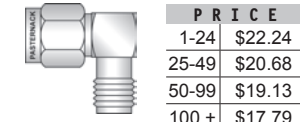
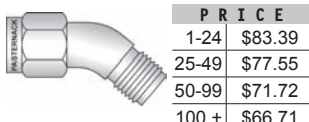
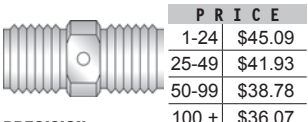
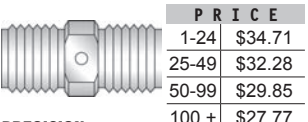
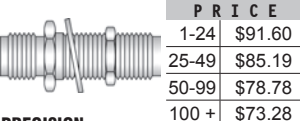
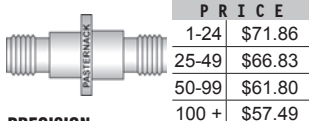
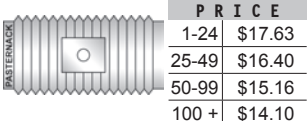
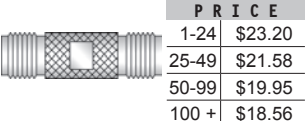









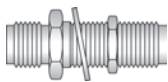
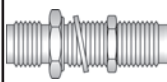







	A	B	C	D																																								
1	 <p><b>SMA In-Series</b></p>	 <table border="1"> <thead> <tr> <th colspan="2">PRICE</th> </tr> </thead> <tbody> <tr> <td>1-24</td> <td>\$54.39</td> </tr> <tr> <td>25-49</td> <td>\$50.58</td> </tr> <tr> <td>50-99</td> <td>\$46.78</td> </tr> <tr> <td>100 +</td> <td>\$43.51</td> </tr> </tbody> </table> <p><b>PRECISION</b></p> <p>Model No: <b>PE9505</b></p> <p>SMA Male To SMA Male Max VSWR 1.15:1 @ 18 GHz 1.20:1 @ 26.5 GHz</p>	PRICE		1-24	\$54.39	25-49	\$50.58	50-99	\$46.78	100 +	\$43.51	 <table border="1"> <thead> <tr> <th colspan="2">PRICE</th> </tr> </thead> <tbody> <tr> <td>1-24</td> <td>\$107.76</td> </tr> <tr> <td>25-49</td> <td>\$100.22</td> </tr> <tr> <td>50-99</td> <td>\$92.67</td> </tr> <tr> <td>100 +</td> <td>\$86.21</td> </tr> </tbody> </table> <p><b>PRECISION</b></p> <p>Model No: <b>PE9669</b></p> <p>SMA Male To SMA Male 4 Hole Panel Mount Mounting Hole A01 Max VSWR 1.25:1 @ 18 GHz</p>	PRICE		1-24	\$107.76	25-49	\$100.22	50-99	\$92.67	100 +	\$86.21	 <table border="1"> <thead> <tr> <th colspan="2">PRICE</th> </tr> </thead> <tbody> <tr> <td>1-24</td> <td>\$17.62</td> </tr> <tr> <td>25-49</td> <td>\$16.39</td> </tr> <tr> <td>50-99</td> <td>\$15.15</td> </tr> <tr> <td>100 +</td> <td>\$14.10</td> </tr> </tbody> </table> <p>Model No: <b>PE9069</b></p> <p>SMA Male To SMA Male</p>	PRICE		1-24	\$17.62	25-49	\$16.39	50-99	\$15.15	100 +	\$14.10										
PRICE																																												
1-24	\$54.39																																											
25-49	\$50.58																																											
50-99	\$46.78																																											
100 +	\$43.51																																											
PRICE																																												
1-24	\$107.76																																											
25-49	\$100.22																																											
50-99	\$92.67																																											
100 +	\$86.21																																											
PRICE																																												
1-24	\$17.62																																											
25-49	\$16.39																																											
50-99	\$15.15																																											
100 +	\$14.10																																											
2	 <table border="1"> <thead> <tr> <th colspan="2">PRICE</th> </tr> </thead> <tbody> <tr> <td>1-24</td> <td>\$54.62</td> </tr> <tr> <td>25-49</td> <td>\$50.80</td> </tr> <tr> <td>50-99</td> <td>\$46.97</td> </tr> <tr> <td>100 +</td> <td>\$43.70</td> </tr> </tbody> </table> <p>Model No: <b>PE9273</b></p> <p>SMA Male To SMA Male Radius Right Angle</p>	PRICE		1-24	\$54.62	25-49	\$50.80	50-99	\$46.97	100 +	\$43.70	 <table border="1"> <thead> <tr> <th colspan="2">PRICE</th> </tr> </thead> <tbody> <tr> <td>1-24</td> <td>\$63.58</td> </tr> <tr> <td>25-49</td> <td>\$59.13</td> </tr> <tr> <td>50-99</td> <td>\$54.68</td> </tr> <tr> <td>100 +</td> <td>\$50.86</td> </tr> </tbody> </table> <p><b>PRECISION</b></p> <p>Model No: <b>PE9642</b></p> <p>SMA Male To SMA Male Right Angle Max VSWR 1.35:1 @ 27 GHz</p>	PRICE		1-24	\$63.58	25-49	\$59.13	50-99	\$54.68	100 +	\$50.86	 <table border="1"> <thead> <tr> <th colspan="2">PRICE</th> </tr> </thead> <tbody> <tr> <td>1-24</td> <td>\$36.61</td> </tr> <tr> <td>25-49</td> <td>\$34.05</td> </tr> <tr> <td>50-99</td> <td>\$31.48</td> </tr> <tr> <td>100 +</td> <td>\$29.29</td> </tr> </tbody> </table> <p>Model No: <b>PE9418</b></p> <p>SMA Male To SMA Male Right Angle</p>	PRICE		1-24	\$36.61	25-49	\$34.05	50-99	\$31.48	100 +	\$29.29	 <table border="1"> <thead> <tr> <th colspan="2">PRICE</th> </tr> </thead> <tbody> <tr> <td>1-24</td> <td>\$46.41</td> </tr> <tr> <td>25-49</td> <td>\$43.16</td> </tr> <tr> <td>50-99</td> <td>\$39.91</td> </tr> <tr> <td>100 +</td> <td>\$37.13</td> </tr> </tbody> </table> <p><b>PRECISION</b></p> <p>Model No: <b>PE9506</b></p> <p>SMA Male To SMA Female Max VSWR 1.15:1 @ 18 GHz 1.20:1 @ 26.5 GHz</p>	PRICE		1-24	\$46.41	25-49	\$43.16	50-99	\$39.91	100 +	\$37.13
PRICE																																												
1-24	\$54.62																																											
25-49	\$50.80																																											
50-99	\$46.97																																											
100 +	\$43.70																																											
PRICE																																												
1-24	\$63.58																																											
25-49	\$59.13																																											
50-99	\$54.68																																											
100 +	\$50.86																																											
PRICE																																												
1-24	\$36.61																																											
25-49	\$34.05																																											
50-99	\$31.48																																											
100 +	\$29.29																																											
PRICE																																												
1-24	\$46.41																																											
25-49	\$43.16																																											
50-99	\$39.91																																											
100 +	\$37.13																																											
3	 <table border="1"> <thead> <tr> <th colspan="2">PRICE</th> </tr> </thead> <tbody> <tr> <td>1-24</td> <td>\$35.93</td> </tr> <tr> <td>25-49</td> <td>\$33.41</td> </tr> <tr> <td>50-99</td> <td>\$30.90</td> </tr> <tr> <td>100 +</td> <td>\$28.74</td> </tr> </tbody> </table> <p><b>PRECISION</b></p> <p>Model No: <b>PE9694</b></p> <p>SMA Male To SMA Female Max VSWR 1.15:1 @ 18 GHz</p>	PRICE		1-24	\$35.93	25-49	\$33.41	50-99	\$30.90	100 +	\$28.74	 <table border="1"> <thead> <tr> <th colspan="2">PRICE</th> </tr> </thead> <tbody> <tr> <td>1-24</td> <td>\$94.08</td> </tr> <tr> <td>25-49</td> <td>\$87.49</td> </tr> <tr> <td>50-99</td> <td>\$80.91</td> </tr> <tr> <td>100 +</td> <td>\$75.26</td> </tr> </tbody> </table> <p><b>PRECISION</b></p> <p>Model No: <b>PE9774</b></p> <p>SMA Male Quick-Disconnect To SMA Female Max VSWR 1.15:1 @ 18 GHz</p>	PRICE		1-24	\$94.08	25-49	\$87.49	50-99	\$80.91	100 +	\$75.26	 <table border="1"> <thead> <tr> <th colspan="2">PRICE</th> </tr> </thead> <tbody> <tr> <td>1-24</td> <td>\$69.41</td> </tr> <tr> <td>25-49</td> <td>\$64.55</td> </tr> <tr> <td>50-99</td> <td>\$59.69</td> </tr> <tr> <td>100 +</td> <td>\$55.53</td> </tr> </tbody> </table> <p><b>PRECISION</b></p> <p>Model No: <b>PE9671</b></p> <p>SMA Male To SMA Female 4 Hole Panel Mount Mounting Hole A01 Max VSWR 1.25:1 @ 18 GHz</p>	PRICE		1-24	\$69.41	25-49	\$64.55	50-99	\$59.69	100 +	\$55.53	 <table border="1"> <thead> <tr> <th colspan="2">PRICE</th> </tr> </thead> <tbody> <tr> <td>1-24</td> <td>\$18.10</td> </tr> <tr> <td>25-49</td> <td>\$16.83</td> </tr> <tr> <td>50-99</td> <td>\$15.57</td> </tr> <tr> <td>100 +</td> <td>\$14.48</td> </tr> </tbody> </table> <p>Model No: <b>PE9103</b></p> <p>SMA Male To SMA Female</p>	PRICE		1-24	\$18.10	25-49	\$16.83	50-99	\$15.57	100 +	\$14.48
PRICE																																												
1-24	\$35.93																																											
25-49	\$33.41																																											
50-99	\$30.90																																											
100 +	\$28.74																																											
PRICE																																												
1-24	\$94.08																																											
25-49	\$87.49																																											
50-99	\$80.91																																											
100 +	\$75.26																																											
PRICE																																												
1-24	\$69.41																																											
25-49	\$64.55																																											
50-99	\$59.69																																											
100 +	\$55.53																																											
PRICE																																												
1-24	\$18.10																																											
25-49	\$16.83																																											
50-99	\$15.57																																											
100 +	\$14.48																																											
4	 <table border="1"> <thead> <tr> <th colspan="2">PRICE</th> </tr> </thead> <tbody> <tr> <td>1-24</td> <td>\$110.10</td> </tr> <tr> <td>25-49</td> <td>\$102.39</td> </tr> <tr> <td>50-99</td> <td>\$94.69</td> </tr> <tr> <td>100 +</td> <td>\$88.08</td> </tr> </tbody> </table> <p>Model No: <b>PE9546</b></p> <p>SMA Male Quick Disconnect To SMA Female</p>	PRICE		1-24	\$110.10	25-49	\$102.39	50-99	\$94.69	100 +	\$88.08	 <table border="1"> <thead> <tr> <th colspan="2">PRICE</th> </tr> </thead> <tbody> <tr> <td>1-24</td> <td>\$38.30</td> </tr> <tr> <td>25-49</td> <td>\$35.62</td> </tr> <tr> <td>50-99</td> <td>\$32.94</td> </tr> <tr> <td>100 +</td> <td>\$30.64</td> </tr> </tbody> </table> <p>Model No: <b>PE9621</b></p> <p>SMA Male To SMA Female Bulkhead Mounting Hole B02</p>	PRICE		1-24	\$38.30	25-49	\$35.62	50-99	\$32.94	100 +	\$30.64	 <table border="1"> <thead> <tr> <th colspan="2">PRICE</th> </tr> </thead> <tbody> <tr> <td>1-24</td> <td>\$43.88</td> </tr> <tr> <td>25-49</td> <td>\$40.81</td> </tr> <tr> <td>50-99</td> <td>\$37.74</td> </tr> <tr> <td>100 +</td> <td>\$35.10</td> </tr> </tbody> </table> <p>Model No: <b>PE9262</b></p> <p>SMA Male To SMA Female Radius Right Angle</p>	PRICE		1-24	\$43.88	25-49	\$40.81	50-99	\$37.74	100 +	\$35.10	 <table border="1"> <thead> <tr> <th colspan="2">PRICE</th> </tr> </thead> <tbody> <tr> <td>1-24</td> <td>\$52.18</td> </tr> <tr> <td>25-49</td> <td>\$48.53</td> </tr> <tr> <td>50-99</td> <td>\$44.87</td> </tr> <tr> <td>100 +</td> <td>\$41.74</td> </tr> </tbody> </table> <p><b>PRECISION</b></p> <p>Model No: <b>PE9641</b></p> <p>SMA Male To SMA Female Right Angle Max VSWR 1.35:1 @ 27 GHz</p>	PRICE		1-24	\$52.18	25-49	\$48.53	50-99	\$44.87	100 +	\$41.74
PRICE																																												
1-24	\$110.10																																											
25-49	\$102.39																																											
50-99	\$94.69																																											
100 +	\$88.08																																											
PRICE																																												
1-24	\$38.30																																											
25-49	\$35.62																																											
50-99	\$32.94																																											
100 +	\$30.64																																											
PRICE																																												
1-24	\$43.88																																											
25-49	\$40.81																																											
50-99	\$37.74																																											
100 +	\$35.10																																											
PRICE																																												
1-24	\$52.18																																											
25-49	\$48.53																																											
50-99	\$44.87																																											
100 +	\$41.74																																											
5	 <table border="1"> <thead> <tr> <th colspan="2">PRICE</th> </tr> </thead> <tbody> <tr> <td>1-24</td> <td>\$22.24</td> </tr> <tr> <td>25-49</td> <td>\$20.68</td> </tr> <tr> <td>50-99</td> <td>\$19.13</td> </tr> <tr> <td>100 +</td> <td>\$17.79</td> </tr> </tbody> </table> <p>Model No: <b>PE9068</b></p> <p>SMA Male To SMA Female Right Angle</p>	PRICE		1-24	\$22.24	25-49	\$20.68	50-99	\$19.13	100 +	\$17.79	 <table border="1"> <thead> <tr> <th colspan="2">PRICE</th> </tr> </thead> <tbody> <tr> <td>1-24</td> <td>\$83.39</td> </tr> <tr> <td>25-49</td> <td>\$77.55</td> </tr> <tr> <td>50-99</td> <td>\$71.72</td> </tr> <tr> <td>100 +</td> <td>\$66.71</td> </tr> </tbody> </table> <p>Model No: <b>PE9381</b></p> <p>SMA Male To SMA Female 45 Degree Angle</p>	PRICE		1-24	\$83.39	25-49	\$77.55	50-99	\$71.72	100 +	\$66.71	 <table border="1"> <thead> <tr> <th colspan="2">PRICE</th> </tr> </thead> <tbody> <tr> <td>1-24</td> <td>\$45.09</td> </tr> <tr> <td>25-49</td> <td>\$41.93</td> </tr> <tr> <td>50-99</td> <td>\$38.78</td> </tr> <tr> <td>100 +</td> <td>\$36.07</td> </tr> </tbody> </table> <p><b>PRECISION</b></p> <p>Model No: <b>PE9507</b></p> <p>SMA Female To SMA Female Max VSWR 1.15:1 @ 18 GHz 1.20:1 @ 26.5 GHz</p>	PRICE		1-24	\$45.09	25-49	\$41.93	50-99	\$38.78	100 +	\$36.07	 <table border="1"> <thead> <tr> <th colspan="2">PRICE</th> </tr> </thead> <tbody> <tr> <td>1-24</td> <td>\$34.71</td> </tr> <tr> <td>25-49</td> <td>\$32.28</td> </tr> <tr> <td>50-99</td> <td>\$29.85</td> </tr> <tr> <td>100 +</td> <td>\$27.77</td> </tr> </tbody> </table> <p><b>PRECISION</b></p> <p>Model No: <b>PE9695</b></p> <p>SMA Female To SMA Female Max VSWR 1.15:1 @ 18 GHz</p>	PRICE		1-24	\$34.71	25-49	\$32.28	50-99	\$29.85	100 +	\$27.77
PRICE																																												
1-24	\$22.24																																											
25-49	\$20.68																																											
50-99	\$19.13																																											
100 +	\$17.79																																											
PRICE																																												
1-24	\$83.39																																											
25-49	\$77.55																																											
50-99	\$71.72																																											
100 +	\$66.71																																											
PRICE																																												
1-24	\$45.09																																											
25-49	\$41.93																																											
50-99	\$38.78																																											
100 +	\$36.07																																											
PRICE																																												
1-24	\$34.71																																											
25-49	\$32.28																																											
50-99	\$29.85																																											
100 +	\$27.77																																											
6	 <table border="1"> <thead> <tr> <th colspan="2">PRICE</th> </tr> </thead> <tbody> <tr> <td>1-24</td> <td>\$91.60</td> </tr> <tr> <td>25-49</td> <td>\$85.19</td> </tr> <tr> <td>50-99</td> <td>\$78.78</td> </tr> <tr> <td>100 +</td> <td>\$73.28</td> </tr> </tbody> </table> <p><b>PRECISION</b></p> <p>Model No: <b>PE9508</b></p> <p>SMA Female To SMA Female Bulkhead, Mounting Hole B02 Max VSWR 1.15:1 @ 18 GHz 1.30:1 @ 26.5 GHz</p>	PRICE		1-24	\$91.60	25-49	\$85.19	50-99	\$78.78	100 +	\$73.28	 <table border="1"> <thead> <tr> <th colspan="2">PRICE</th> </tr> </thead> <tbody> <tr> <td>1-24</td> <td>\$71.86</td> </tr> <tr> <td>25-49</td> <td>\$66.83</td> </tr> <tr> <td>50-99</td> <td>\$61.80</td> </tr> <tr> <td>100 +</td> <td>\$57.49</td> </tr> </tbody> </table> <p><b>PRECISION</b></p> <p>Model No: <b>PE9670</b></p> <p>SMA Female To SMA Female 4 Hole Panel Mount Mounting Hole A01 Max VSWR 1.25:1 @ 18 GHz</p>	PRICE		1-24	\$71.86	25-49	\$66.83	50-99	\$61.80	100 +	\$57.49	 <table border="1"> <thead> <tr> <th colspan="2">PRICE</th> </tr> </thead> <tbody> <tr> <td>1-24</td> <td>\$17.63</td> </tr> <tr> <td>25-49</td> <td>\$16.40</td> </tr> <tr> <td>50-99</td> <td>\$15.16</td> </tr> <tr> <td>100 +</td> <td>\$14.10</td> </tr> </tbody> </table> <p>Model No: <b>PE9070</b></p> <p>SMA Female To SMA Female</p>	PRICE		1-24	\$17.63	25-49	\$16.40	50-99	\$15.16	100 +	\$14.10	 <table border="1"> <thead> <tr> <th colspan="2">PRICE</th> </tr> </thead> <tbody> <tr> <td>1-24</td> <td>\$23.20</td> </tr> <tr> <td>25-49</td> <td>\$21.58</td> </tr> <tr> <td>50-99</td> <td>\$19.95</td> </tr> <tr> <td>100 +</td> <td>\$18.56</td> </tr> </tbody> </table> <p>Model No: <b>PE9380</b></p> <p>SMA Female To SMA Female With Knurl</p>	PRICE		1-24	\$23.20	25-49	\$21.58	50-99	\$19.95	100 +	\$18.56
PRICE																																												
1-24	\$91.60																																											
25-49	\$85.19																																											
50-99	\$78.78																																											
100 +	\$73.28																																											
PRICE																																												
1-24	\$71.86																																											
25-49	\$66.83																																											
50-99	\$61.80																																											
100 +	\$57.49																																											
PRICE																																												
1-24	\$17.63																																											
25-49	\$16.40																																											
50-99	\$15.16																																											
100 +	\$14.10																																											
PRICE																																												
1-24	\$23.20																																											
25-49	\$21.58																																											
50-99	\$19.95																																											
100 +	\$18.56																																											

ROHS & REACH COMPLIANT. CUSTOM-LENGTH CABLE ASSEMBLIES MAY BE ORDERED ON OUR WEBSITE.

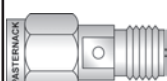
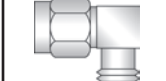
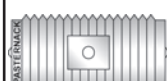
# ADAPTERS

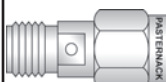
See Adapter Locator on Pages 140-145 or the Adapter Matrix on Pages 138-139

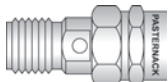
See Page 246 for Mounting Holes

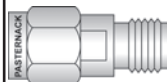
	A	B	C	D																																								
1	 <table border="1"> <thead> <tr> <th colspan="2">PRICE</th> </tr> </thead> <tbody> <tr> <td>1-24</td> <td>\$23.15</td> </tr> <tr> <td>25-49</td> <td>\$21.53</td> </tr> <tr> <td>50-99</td> <td>\$19.91</td> </tr> <tr> <td>100 +</td> <td>\$18.52</td> </tr> </tbody> </table>	PRICE		1-24	\$23.15	25-49	\$21.53	50-99	\$19.91	100 +	\$18.52	 <table border="1"> <thead> <tr> <th colspan="2">PRICE</th> </tr> </thead> <tbody> <tr> <td>1-24</td> <td>\$25.38</td> </tr> <tr> <td>25-49</td> <td>\$23.60</td> </tr> <tr> <td>50-99</td> <td>\$21.83</td> </tr> <tr> <td>100 +</td> <td>\$20.30</td> </tr> </tbody> </table>	PRICE		1-24	\$25.38	25-49	\$23.60	50-99	\$21.83	100 +	\$20.30	 <table border="1"> <thead> <tr> <th colspan="2">PRICE</th> </tr> </thead> <tbody> <tr> <td>1-24</td> <td>\$34.35</td> </tr> <tr> <td>25-49</td> <td>\$31.95</td> </tr> <tr> <td>50-99</td> <td>\$29.54</td> </tr> <tr> <td>100 +</td> <td>\$27.48</td> </tr> </tbody> </table>	PRICE		1-24	\$34.35	25-49	\$31.95	50-99	\$29.54	100 +	\$27.48	 <table border="1"> <thead> <tr> <th colspan="2">PRICE</th> </tr> </thead> <tbody> <tr> <td>1-24</td> <td>\$28.07</td> </tr> <tr> <td>25-49</td> <td>\$26.11</td> </tr> <tr> <td>50-99</td> <td>\$24.14</td> </tr> <tr> <td>100 +</td> <td>\$22.46</td> </tr> </tbody> </table>	PRICE		1-24	\$28.07	25-49	\$26.11	50-99	\$24.14	100 +	\$22.46
	PRICE																																											
1-24	\$23.15																																											
25-49	\$21.53																																											
50-99	\$19.91																																											
100 +	\$18.52																																											
PRICE																																												
1-24	\$25.38																																											
25-49	\$23.60																																											
50-99	\$21.83																																											
100 +	\$20.30																																											
PRICE																																												
1-24	\$34.35																																											
25-49	\$31.95																																											
50-99	\$29.54																																											
100 +	\$27.48																																											
PRICE																																												
1-24	\$28.07																																											
25-49	\$26.11																																											
50-99	\$24.14																																											
100 +	\$22.46																																											
<b>Model No: PE9071</b> SMA Female To SMA Female Bulkhead Mounting Hole B02		<b>Model No: PE9620</b> SMA Female To SMA Female Bulkhead With O-Ring Mounting Hole B02		<b>Model No: PE9184</b> SMA Female To SMA Female Bulkhead, Hermetically Sealed Mounting Hole B03		<b>Model No: PE9067</b> SMA Female To SMA Female Bulkhead, Isolated Ground Mounting Hole B03																																						
2	 <table border="1"> <thead> <tr> <th colspan="2">PRICE</th> </tr> </thead> <tbody> <tr> <td>1-24</td> <td>\$47.94</td> </tr> <tr> <td>25-49</td> <td>\$44.58</td> </tr> <tr> <td>50-99</td> <td>\$41.23</td> </tr> <tr> <td>100 +</td> <td>\$38.35</td> </tr> </tbody> </table>	PRICE		1-24	\$47.94	25-49	\$44.58	50-99	\$41.23	100 +	\$38.35	 <table border="1"> <thead> <tr> <th colspan="2">PRICE</th> </tr> </thead> <tbody> <tr> <td>1-24</td> <td>\$69.41</td> </tr> <tr> <td>25-49</td> <td>\$64.55</td> </tr> <tr> <td>50-99</td> <td>\$59.69</td> </tr> <tr> <td>100 +</td> <td>\$55.53</td> </tr> </tbody> </table>	PRICE		1-24	\$69.41	25-49	\$64.55	50-99	\$59.69	100 +	\$55.53	 <table border="1"> <thead> <tr> <th colspan="2">PRICE</th> </tr> </thead> <tbody> <tr> <td>1-24</td> <td>\$69.41</td> </tr> <tr> <td>25-49</td> <td>\$64.55</td> </tr> <tr> <td>50-99</td> <td>\$59.69</td> </tr> <tr> <td>100 +</td> <td>\$55.53</td> </tr> </tbody> </table>	PRICE		1-24	\$69.41	25-49	\$64.55	50-99	\$59.69	100 +	\$55.53	 <table border="1"> <thead> <tr> <th colspan="2">PRICE</th> </tr> </thead> <tbody> <tr> <td>1-24</td> <td>\$33.79</td> </tr> <tr> <td>25-49</td> <td>\$31.42</td> </tr> <tr> <td>50-99</td> <td>\$29.06</td> </tr> <tr> <td>100 +</td> <td>\$27.03</td> </tr> </tbody> </table>	PRICE		1-24	\$33.79	25-49	\$31.42	50-99	\$29.06	100 +	\$27.03
	PRICE																																											
1-24	\$47.94																																											
25-49	\$44.58																																											
50-99	\$41.23																																											
100 +	\$38.35																																											
PRICE																																												
1-24	\$69.41																																											
25-49	\$64.55																																											
50-99	\$59.69																																											
100 +	\$55.53																																											
PRICE																																												
1-24	\$69.41																																											
25-49	\$64.55																																											
50-99	\$59.69																																											
100 +	\$55.53																																											
PRICE																																												
1-24	\$33.79																																											
25-49	\$31.42																																											
50-99	\$29.06																																											
100 +	\$27.03																																											
<b>Model No: PE9312</b> SMA Female To SMA Female Panel Mount Mounting Hole A01		<b>Model No: PE9274</b> SMA Female To SMA Female Radius Right Angle		<b>Model No: PE9643</b> SMA Female To SMA Female Right Angle Max VSWR 1.35:1 @ 27 GHz		<b>Model No: PE9485</b> SMA Female To SMA Female Right Angle																																						
3	 <table border="1"> <thead> <tr> <th colspan="2">PRICE</th> </tr> </thead> <tbody> <tr> <td>1-24</td> <td>\$52.69</td> </tr> <tr> <td>25-49</td> <td>\$49.00</td> </tr> <tr> <td>50-99</td> <td>\$45.31</td> </tr> <tr> <td>100 +</td> <td>\$42.15</td> </tr> </tbody> </table>	PRICE		1-24	\$52.69	25-49	\$49.00	50-99	\$45.31	100 +	\$42.15	 <table border="1"> <thead> <tr> <th colspan="2">PRICE</th> </tr> </thead> <tbody> <tr> <td>1-24</td> <td>\$57.81</td> </tr> <tr> <td>25-49</td> <td>\$53.76</td> </tr> <tr> <td>50-99</td> <td>\$49.72</td> </tr> <tr> <td>100 +</td> <td>\$46.25</td> </tr> </tbody> </table>	PRICE		1-24	\$57.81	25-49	\$53.76	50-99	\$49.72	100 +	\$46.25	 <table border="1"> <thead> <tr> <th colspan="2">PRICE</th> </tr> </thead> <tbody> <tr> <td>1-24</td> <td>\$37.64</td> </tr> <tr> <td>25-49</td> <td>\$35.01</td> </tr> <tr> <td>50-99</td> <td>\$32.37</td> </tr> <tr> <td>100 +</td> <td>\$30.11</td> </tr> </tbody> </table>	PRICE		1-24	\$37.64	25-49	\$35.01	50-99	\$32.37	100 +	\$30.11	 <table border="1"> <thead> <tr> <th colspan="2">PRICE</th> </tr> </thead> <tbody> <tr> <td>1-24</td> <td>\$48.79</td> </tr> <tr> <td>25-49</td> <td>\$45.37</td> </tr> <tr> <td>50-99</td> <td>\$41.96</td> </tr> <tr> <td>100 +</td> <td>\$39.03</td> </tr> </tbody> </table>	PRICE		1-24	\$48.79	25-49	\$45.37	50-99	\$41.96	100 +	\$39.03
	PRICE																																											
1-24	\$52.69																																											
25-49	\$49.00																																											
50-99	\$45.31																																											
100 +	\$42.15																																											
PRICE																																												
1-24	\$57.81																																											
25-49	\$53.76																																											
50-99	\$49.72																																											
100 +	\$46.25																																											
PRICE																																												
1-24	\$37.64																																											
25-49	\$35.01																																											
50-99	\$32.37																																											
100 +	\$30.11																																											
PRICE																																												
1-24	\$48.79																																											
25-49	\$45.37																																											
50-99	\$41.96																																											
100 +	\$39.03																																											
<b>Model No: PE9379</b> SMA "T" Male-Male-Male		<b>Model No: PE9247</b> SMA "T" Male-Female-Male		<b>Model No: PE9182</b> SMA "T" Female-Male-Female		<b>Model No: PE9246</b> SMA "T" Female-Female-Female																																						
4	 <table border="1"> <thead> <tr> <th colspan="2">PRICE</th> </tr> </thead> <tbody> <tr> <td>1-24</td> <td>\$35.26</td> </tr> <tr> <td>25-49</td> <td>\$32.79</td> </tr> <tr> <td>50-99</td> <td>\$30.32</td> </tr> <tr> <td>100 +</td> <td>\$28.21</td> </tr> </tbody> </table>	PRICE		1-24	\$35.26	25-49	\$32.79	50-99	\$30.32	100 +	\$28.21	 <table border="1"> <thead> <tr> <th colspan="2">PRICE</th> </tr> </thead> <tbody> <tr> <td>1-24</td> <td>\$35.26</td> </tr> <tr> <td>25-49</td> <td>\$32.79</td> </tr> <tr> <td>50-99</td> <td>\$30.32</td> </tr> <tr> <td>100 +</td> <td>\$28.21</td> </tr> </tbody> </table>	PRICE		1-24	\$35.26	25-49	\$32.79	50-99	\$30.32	100 +	\$28.21	 <table border="1"> <thead> <tr> <th colspan="2">PRICE</th> </tr> </thead> <tbody> <tr> <td>1-24</td> <td>\$25.89</td> </tr> <tr> <td>25-49</td> <td>\$24.08</td> </tr> <tr> <td>50-99</td> <td>\$22.27</td> </tr> <tr> <td>100 +</td> <td>\$20.71</td> </tr> </tbody> </table>	PRICE		1-24	\$25.89	25-49	\$24.08	50-99	\$22.27	100 +	\$20.71	 <table border="1"> <thead> <tr> <th colspan="2">PRICE</th> </tr> </thead> <tbody> <tr> <td>1-24</td> <td>\$20.87</td> </tr> <tr> <td>25-49</td> <td>\$19.41</td> </tr> <tr> <td>50-99</td> <td>\$17.95</td> </tr> <tr> <td>100 +</td> <td>\$16.70</td> </tr> </tbody> </table>	PRICE		1-24	\$20.87	25-49	\$19.41	50-99	\$17.95	100 +	\$16.70
	PRICE																																											
1-24	\$35.26																																											
25-49	\$32.79																																											
50-99	\$30.32																																											
100 +	\$28.21																																											
PRICE																																												
1-24	\$35.26																																											
25-49	\$32.79																																											
50-99	\$30.32																																											
100 +	\$28.21																																											
PRICE																																												
1-24	\$25.89																																											
25-49	\$24.08																																											
50-99	\$22.27																																											
100 +	\$20.71																																											
PRICE																																												
1-24	\$20.87																																											
25-49	\$19.41																																											
50-99	\$17.95																																											
100 +	\$16.70																																											
<b>Model No: PE9590</b> Reverse Polarity SMA Male To Reverse Polarity SMA Male		<b>Model No: PE9591</b> Reverse Polarity SMA Male To Reverse Polarity SMA Female		<b>Model No: PE9594</b> Reverse Polarity SMA Male To Reverse Polarity SMA Female Right Angle		<b>Model No: PE9592</b> Reverse Polarity SMA Female To Reverse Polarity SMA Female																																						
5	 <table border="1"> <thead> <tr> <th colspan="2">PRICE</th> </tr> </thead> <tbody> <tr> <td>1-24</td> <td>\$34.71</td> </tr> <tr> <td>25-49</td> <td>\$32.28</td> </tr> <tr> <td>50-99</td> <td>\$29.85</td> </tr> <tr> <td>100 +</td> <td>\$27.77</td> </tr> </tbody> </table>	PRICE		1-24	\$34.71	25-49	\$32.28	50-99	\$29.85	100 +	\$27.77	 <table border="1"> <thead> <tr> <th colspan="2">PRICE</th> </tr> </thead> <tbody> <tr> <td>1-24</td> <td>\$32.88</td> </tr> <tr> <td>25-49</td> <td>\$30.58</td> </tr> <tr> <td>50-99</td> <td>\$28.28</td> </tr> <tr> <td>100 +</td> <td>\$26.30</td> </tr> </tbody> </table>	PRICE		1-24	\$32.88	25-49	\$30.58	50-99	\$28.28	100 +	\$26.30	 <table border="1"> <thead> <tr> <th colspan="2">PRICE</th> </tr> </thead> <tbody> <tr> <td>1-24</td> <td>\$23.36</td> </tr> <tr> <td>25-49</td> <td>\$21.72</td> </tr> <tr> <td>50-99</td> <td>\$20.09</td> </tr> <tr> <td>100 +</td> <td>\$18.69</td> </tr> </tbody> </table>	PRICE		1-24	\$23.36	25-49	\$21.72	50-99	\$20.09	100 +	\$18.69	 <table border="1"> <thead> <tr> <th colspan="2">PRICE</th> </tr> </thead> <tbody> <tr> <td>1-24</td> <td>\$35.26</td> </tr> <tr> <td>25-49</td> <td>\$32.79</td> </tr> <tr> <td>50-99</td> <td>\$30.32</td> </tr> <tr> <td>100 +</td> <td>\$28.21</td> </tr> </tbody> </table>	PRICE		1-24	\$35.26	25-49	\$32.79	50-99	\$30.32	100 +	\$28.21
	PRICE																																											
1-24	\$34.71																																											
25-49	\$32.28																																											
50-99	\$29.85																																											
100 +	\$27.77																																											
PRICE																																												
1-24	\$32.88																																											
25-49	\$30.58																																											
50-99	\$28.28																																											
100 +	\$26.30																																											
PRICE																																												
1-24	\$23.36																																											
25-49	\$21.72																																											
50-99	\$20.09																																											
100 +	\$18.69																																											
PRICE																																												
1-24	\$35.26																																											
25-49	\$32.79																																											
50-99	\$30.32																																											
100 +	\$28.21																																											
<b>Model No: PE9593</b> Reverse Polarity SMA Female To Reverse Polarity SMA Female Bulkhead Mounting Hole B02		<b>Model No: PE9534</b> Standard SMA Male To Reverse Polarity SMA Female		<b>Model No: PE9533</b> Standard SMA Female To Reverse Polarity SMA Male		<b>Model No: PE9682</b> SMA Male To Reverse Thread SMA Female																																						
6	 <table border="1"> <thead> <tr> <th colspan="2">PRICE</th> </tr> </thead> <tbody> <tr> <td>1-24</td> <td>\$25.84</td> </tr> <tr> <td>25-49</td> <td>\$24.03</td> </tr> <tr> <td>50-99</td> <td>\$22.22</td> </tr> <tr> <td>100 +</td> <td>\$20.67</td> </tr> </tbody> </table>	PRICE		1-24	\$25.84	25-49	\$24.03	50-99	\$22.22	100 +	\$20.67	<b>SMA Between-Series</b> 		 <table border="1"> <thead> <tr> <th colspan="2">PRICE</th> </tr> </thead> <tbody> <tr> <td>1-24</td> <td>\$153.01</td> </tr> <tr> <td>25-49</td> <td>\$142.30</td> </tr> <tr> <td>50-99</td> <td>\$131.59</td> </tr> <tr> <td>100 +</td> <td>\$122.41</td> </tr> </tbody> </table>	PRICE		1-24	\$153.01	25-49	\$142.30	50-99	\$131.59	100 +	\$122.41	 <table border="1"> <thead> <tr> <th colspan="2">PRICE</th> </tr> </thead> <tbody> <tr> <td>1-24</td> <td>\$144.60</td> </tr> <tr> <td>25-49</td> <td>\$134.48</td> </tr> <tr> <td>50-99</td> <td>\$124.36</td> </tr> <tr> <td>100 +</td> <td>\$115.68</td> </tr> </tbody> </table>	PRICE		1-24	\$144.60	25-49	\$134.48	50-99	\$124.36	100 +	\$115.68									
	PRICE																																											
1-24	\$25.84																																											
25-49	\$24.03																																											
50-99	\$22.22																																											
100 +	\$20.67																																											
PRICE																																												
1-24	\$153.01																																											
25-49	\$142.30																																											
50-99	\$131.59																																											
100 +	\$122.41																																											
PRICE																																												
1-24	\$144.60																																											
25-49	\$134.48																																											
50-99	\$124.36																																											
100 +	\$115.68																																											
<b>Model No: PE9683</b> SMA Female To Reverse Thread SMA Male		<b>PRECISION</b> <b>Model No: PE9722</b> SMA Male To 3.5mm Male Max VSWR 1.25:1 @ 18 GHz		<b>PRECISION</b> <b>Model No: PE9723</b> SMA Male To 3.5mm Female Max VSWR 1.25:1 @ 18 GHz																																								

Adapters

See Our Website For Real-Time Stock Availability!











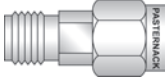
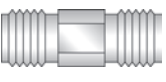

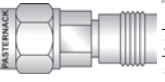
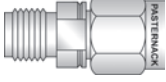
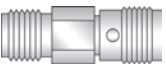
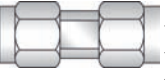
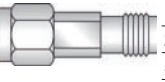
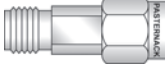
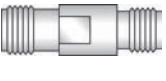
# ADAPTERS

See Adapter Locator on Pages 140-145 or the Adapter Matrix on Pages 138-139

See Page 246 for Mounting Holes

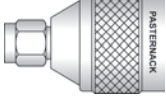
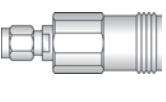
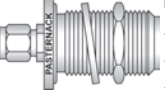
Adapters

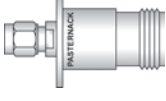
See Our Website For Real-Time Stock Availability!

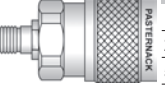









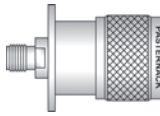

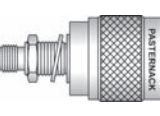
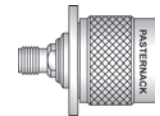
	A	B	C	D																																								
1	 <table border="1"> <thead> <tr> <th colspan="2">PRICE</th> </tr> </thead> <tbody> <tr> <td>1-24</td> <td>\$146.02</td> </tr> <tr> <td>25-49</td> <td>\$135.80</td> </tr> <tr> <td>50-99</td> <td>\$125.58</td> </tr> <tr> <td>100 +</td> <td>\$116.82</td> </tr> </tbody> </table> <p><b>PRECISION</b> Model No: <b>PE9724</b> SMA Female To 3.5mm Male Max VSWR 1.25:1 @ 18 GHz</p>	PRICE		1-24	\$146.02	25-49	\$135.80	50-99	\$125.58	100 +	\$116.82	 <table border="1"> <thead> <tr> <th colspan="2">PRICE</th> </tr> </thead> <tbody> <tr> <td>1-24</td> <td>\$148.85</td> </tr> <tr> <td>25-49</td> <td>\$138.43</td> </tr> <tr> <td>50-99</td> <td>\$128.01</td> </tr> <tr> <td>100 +</td> <td>\$119.08</td> </tr> </tbody> </table> <p><b>PRECISION</b> Model No: <b>PE9725</b> SMA Female To 3.5mm Female Max VSWR 1.25:1 @ 18 GHz</p>	PRICE		1-24	\$148.85	25-49	\$138.43	50-99	\$128.01	100 +	\$119.08	 <table border="1"> <thead> <tr> <th colspan="2">PRICE</th> </tr> </thead> <tbody> <tr> <td>1-24</td> <td>\$156.45</td> </tr> <tr> <td>25-49</td> <td>\$145.50</td> </tr> <tr> <td>50-99</td> <td>\$134.55</td> </tr> <tr> <td>100 +</td> <td>\$125.16</td> </tr> </tbody> </table> <p><b>PRECISION</b> Model No: <b>PE9653</b> SMA Male To 2.4mm Male Max VSWR 1.20:1 @ 26.5 GHz</p>	PRICE		1-24	\$156.45	25-49	\$145.50	50-99	\$134.55	100 +	\$125.16	 <table border="1"> <thead> <tr> <th colspan="2">PRICE</th> </tr> </thead> <tbody> <tr> <td>1-24</td> <td>\$172.21</td> </tr> <tr> <td>25-49</td> <td>\$160.16</td> </tr> <tr> <td>50-99</td> <td>\$148.10</td> </tr> <tr> <td>100 +</td> <td>\$137.77</td> </tr> </tbody> </table> <p><b>PRECISION</b> Model No: <b>PE9654</b> SMA Male To 2.4mm Female Max VSWR 1.20:1 @ 26.5 GHz</p>	PRICE		1-24	\$172.21	25-49	\$160.16	50-99	\$148.10	100 +	\$137.77
	PRICE																																											
1-24	\$146.02																																											
25-49	\$135.80																																											
50-99	\$125.58																																											
100 +	\$116.82																																											
PRICE																																												
1-24	\$148.85																																											
25-49	\$138.43																																											
50-99	\$128.01																																											
100 +	\$119.08																																											
PRICE																																												
1-24	\$156.45																																											
25-49	\$145.50																																											
50-99	\$134.55																																											
100 +	\$125.16																																											
PRICE																																												
1-24	\$172.21																																											
25-49	\$160.16																																											
50-99	\$148.10																																											
100 +	\$137.77																																											
2	 <table border="1"> <thead> <tr> <th colspan="2">PRICE</th> </tr> </thead> <tbody> <tr> <td>1-24</td> <td>\$162.08</td> </tr> <tr> <td>25-49</td> <td>\$150.73</td> </tr> <tr> <td>50-99</td> <td>\$139.39</td> </tr> <tr> <td>100 +</td> <td>\$129.66</td> </tr> </tbody> </table> <p><b>PRECISION</b> Model No: <b>PE9655</b> SMA Female To 2.4mm Male Max VSWR 1.20:1 @ 26.5 GHz</p>	PRICE		1-24	\$162.08	25-49	\$150.73	50-99	\$139.39	100 +	\$129.66	 <table border="1"> <thead> <tr> <th colspan="2">PRICE</th> </tr> </thead> <tbody> <tr> <td>1-24</td> <td>\$164.81</td> </tr> <tr> <td>25-49</td> <td>\$153.27</td> </tr> <tr> <td>50-99</td> <td>\$141.74</td> </tr> <tr> <td>100 +</td> <td>\$131.85</td> </tr> </tbody> </table> <p><b>PRECISION</b> Model No: <b>PE9656</b> SMA Female To 2.4mm Female Max VSWR 1.20:1 @ 26.5 GHz</p>	PRICE		1-24	\$164.81	25-49	\$153.27	50-99	\$141.74	100 +	\$131.85	 <table border="1"> <thead> <tr> <th colspan="2">PRICE</th> </tr> </thead> <tbody> <tr> <td>1-24</td> <td>\$153.01</td> </tr> <tr> <td>25-49</td> <td>\$142.30</td> </tr> <tr> <td>50-99</td> <td>\$131.59</td> </tr> <tr> <td>100 +</td> <td>\$122.41</td> </tr> </tbody> </table> <p><b>PRECISION</b> Model No: <b>PE9727</b> SMA Male To 1.85mm Male Max VSWR 1.30:1 @ 18 GHz</p>	PRICE		1-24	\$153.01	25-49	\$142.30	50-99	\$131.59	100 +	\$122.41	 <table border="1"> <thead> <tr> <th colspan="2">PRICE</th> </tr> </thead> <tbody> <tr> <td>1-24</td> <td>\$153.01</td> </tr> <tr> <td>25-49</td> <td>\$142.30</td> </tr> <tr> <td>50-99</td> <td>\$131.59</td> </tr> <tr> <td>100 +</td> <td>\$122.41</td> </tr> </tbody> </table> <p><b>PRECISION</b> Model No: <b>PE9728</b> SMA Male To 1.85mm Female Max VSWR 1.30:1 @ 18 GHz</p>	PRICE		1-24	\$153.01	25-49	\$142.30	50-99	\$131.59	100 +	\$122.41
	PRICE																																											
1-24	\$162.08																																											
25-49	\$150.73																																											
50-99	\$139.39																																											
100 +	\$129.66																																											
PRICE																																												
1-24	\$164.81																																											
25-49	\$153.27																																											
50-99	\$141.74																																											
100 +	\$131.85																																											
PRICE																																												
1-24	\$153.01																																											
25-49	\$142.30																																											
50-99	\$131.59																																											
100 +	\$122.41																																											
PRICE																																												
1-24	\$153.01																																											
25-49	\$142.30																																											
50-99	\$131.59																																											
100 +	\$122.41																																											
3	 <table border="1"> <thead> <tr> <th colspan="2">PRICE</th> </tr> </thead> <tbody> <tr> <td>1-24</td> <td>\$153.01</td> </tr> <tr> <td>25-49</td> <td>\$142.30</td> </tr> <tr> <td>50-99</td> <td>\$131.59</td> </tr> <tr> <td>100 +</td> <td>\$122.41</td> </tr> </tbody> </table> <p><b>PRECISION</b> Model No: <b>PE9726</b> SMA Female To 1.85mm Male Max VSWR 1.30:1 @ 18 GHz</p>	PRICE		1-24	\$153.01	25-49	\$142.30	50-99	\$131.59	100 +	\$122.41	 <table border="1"> <thead> <tr> <th colspan="2">PRICE</th> </tr> </thead> <tbody> <tr> <td>1-24</td> <td>\$153.01</td> </tr> <tr> <td>25-49</td> <td>\$142.30</td> </tr> <tr> <td>50-99</td> <td>\$131.59</td> </tr> <tr> <td>100 +</td> <td>\$122.41</td> </tr> </tbody> </table> <p><b>PRECISION</b> Model No: <b>PE9729</b> SMA Female To 1.85mm Female Max VSWR 1.30:1 @ 18 GHz</p>	PRICE		1-24	\$153.01	25-49	\$142.30	50-99	\$131.59	100 +	\$122.41	 <table border="1"> <thead> <tr> <th colspan="2">PRICE</th> </tr> </thead> <tbody> <tr> <td>1-24</td> <td>\$47.12</td> </tr> <tr> <td>25-49</td> <td>\$43.82</td> </tr> <tr> <td>50-99</td> <td>\$40.52</td> </tr> <tr> <td>100 +</td> <td>\$37.70</td> </tr> </tbody> </table> <p><b>PRECISION</b> Model No: <b>PE9187</b> SMA Male To SSMA Male</p>	PRICE		1-24	\$47.12	25-49	\$43.82	50-99	\$40.52	100 +	\$37.70	 <table border="1"> <thead> <tr> <th colspan="2">PRICE</th> </tr> </thead> <tbody> <tr> <td>1-24</td> <td>\$41.09</td> </tr> <tr> <td>25-49</td> <td>\$38.21</td> </tr> <tr> <td>50-99</td> <td>\$35.34</td> </tr> <tr> <td>100 +</td> <td>\$32.87</td> </tr> </tbody> </table> <p><b>PRECISION</b> Model No: <b>PE9063</b> SMA Male To SSMA Female</p>	PRICE		1-24	\$41.09	25-49	\$38.21	50-99	\$35.34	100 +	\$32.87
	PRICE																																											
1-24	\$153.01																																											
25-49	\$142.30																																											
50-99	\$131.59																																											
100 +	\$122.41																																											
PRICE																																												
1-24	\$153.01																																											
25-49	\$142.30																																											
50-99	\$131.59																																											
100 +	\$122.41																																											
PRICE																																												
1-24	\$47.12																																											
25-49	\$43.82																																											
50-99	\$40.52																																											
100 +	\$37.70																																											
PRICE																																												
1-24	\$41.09																																											
25-49	\$38.21																																											
50-99	\$35.34																																											
100 +	\$32.87																																											
4	 <table border="1"> <thead> <tr> <th colspan="2">PRICE</th> </tr> </thead> <tbody> <tr> <td>1-24</td> <td>\$38.15</td> </tr> <tr> <td>25-49</td> <td>\$35.48</td> </tr> <tr> <td>50-99</td> <td>\$32.81</td> </tr> <tr> <td>100 +</td> <td>\$30.52</td> </tr> </tbody> </table> <p><b>PRECISION</b> Model No: <b>PE9188</b> SMA Female To SSMA Male</p>	PRICE		1-24	\$38.15	25-49	\$35.48	50-99	\$32.81	100 +	\$30.52	 <table border="1"> <thead> <tr> <th colspan="2">PRICE</th> </tr> </thead> <tbody> <tr> <td>1-24</td> <td>\$46.21</td> </tr> <tr> <td>25-49</td> <td>\$42.98</td> </tr> <tr> <td>50-99</td> <td>\$39.74</td> </tr> <tr> <td>100 +</td> <td>\$36.97</td> </tr> </tbody> </table> <p><b>PRECISION</b> Model No: <b>PE9399</b> SMA Female To SSMA Female</p>	PRICE		1-24	\$46.21	25-49	\$42.98	50-99	\$39.74	100 +	\$36.97	 <table border="1"> <thead> <tr> <th colspan="2">PRICE</th> </tr> </thead> <tbody> <tr> <td>1-24</td> <td>\$92.56</td> </tr> <tr> <td>25-49</td> <td>\$86.08</td> </tr> <tr> <td>50-99</td> <td>\$79.60</td> </tr> <tr> <td>100 +</td> <td>\$74.05</td> </tr> </tbody> </table> <p><b>PRECISION</b> Model No: <b>PE9431</b> SMA Male To N Male Max VSWR 1.15:1 @ 18 GHz</p>	PRICE		1-24	\$92.56	25-49	\$86.08	50-99	\$79.60	100 +	\$74.05	 <table border="1"> <thead> <tr> <th colspan="2">PRICE</th> </tr> </thead> <tbody> <tr> <td>1-24</td> <td>\$105.89</td> </tr> <tr> <td>25-49</td> <td>\$98.48</td> </tr> <tr> <td>50-99</td> <td>\$91.07</td> </tr> <tr> <td>100 +</td> <td>\$84.71</td> </tr> </tbody> </table> <p><b>PRECISION</b> Model No: <b>PE9499</b> SMA Male To N Female Panel Mount, Mounting Hole A05 Max VSWR 1.15:1 @ 18 GHz</p>	PRICE		1-24	\$105.89	25-49	\$98.48	50-99	\$91.07	100 +	\$84.71
	PRICE																																											
1-24	\$38.15																																											
25-49	\$35.48																																											
50-99	\$32.81																																											
100 +	\$30.52																																											
PRICE																																												
1-24	\$46.21																																											
25-49	\$42.98																																											
50-99	\$39.74																																											
100 +	\$36.97																																											
PRICE																																												
1-24	\$92.56																																											
25-49	\$86.08																																											
50-99	\$79.60																																											
100 +	\$74.05																																											
PRICE																																												
1-24	\$105.89																																											
25-49	\$98.48																																											
50-99	\$91.07																																											
100 +	\$84.71																																											
5	 <table border="1"> <thead> <tr> <th colspan="2">PRICE</th> </tr> </thead> <tbody> <tr> <td>1-24</td> <td>\$40.63</td> </tr> <tr> <td>25-49</td> <td>\$37.79</td> </tr> <tr> <td>50-99</td> <td>\$34.94</td> </tr> <tr> <td>100 +</td> <td>\$32.50</td> </tr> </tbody> </table> <p><b>PRECISION</b> Model No: <b>PE9080</b> SMA Male To N Male</p>	PRICE		1-24	\$40.63	25-49	\$37.79	50-99	\$34.94	100 +	\$32.50	 <table border="1"> <thead> <tr> <th colspan="2">PRICE</th> </tr> </thead> <tbody> <tr> <td>1-24</td> <td>\$75.36</td> </tr> <tr> <td>25-49</td> <td>\$70.08</td> </tr> <tr> <td>50-99</td> <td>\$64.81</td> </tr> <tr> <td>100 +</td> <td>\$60.29</td> </tr> </tbody> </table> <p><b>PRECISION</b> Model No: <b>PE9433</b> SMA Male To N Female Max VSWR 1.15:1 @ 18 GHz</p>	PRICE		1-24	\$75.36	25-49	\$70.08	50-99	\$64.81	100 +	\$60.29	 <table border="1"> <thead> <tr> <th colspan="2">PRICE</th> </tr> </thead> <tbody> <tr> <td>1-24</td> <td>\$104.12</td> </tr> <tr> <td>25-49</td> <td>\$96.83</td> </tr> <tr> <td>50-99</td> <td>\$89.54</td> </tr> <tr> <td>100 +</td> <td>\$83.30</td> </tr> </tbody> </table> <p><b>PRECISION</b> Model No: <b>PE9487</b> SMA Male To N Female Bulkhead Max VSWR 1.15:1 @ 18 GHz Mounting Hole G01</p>	PRICE		1-24	\$104.12	25-49	\$96.83	50-99	\$89.54	100 +	\$83.30	 <table border="1"> <thead> <tr> <th colspan="2">PRICE</th> </tr> </thead> <tbody> <tr> <td>1-24</td> <td>\$105.84</td> </tr> <tr> <td>25-49</td> <td>\$98.43</td> </tr> <tr> <td>50-99</td> <td>\$91.02</td> </tr> <tr> <td>100 +</td> <td>\$84.67</td> </tr> </tbody> </table> <p><b>PRECISION</b> Model No: <b>PE9488</b> SMA Male Bulkhead To N Female Nut On SMA, Mounting Hole G01 Max VSWR 1.15:1 @ 18 GHz</p>	PRICE		1-24	\$105.84	25-49	\$98.43	50-99	\$91.02	100 +	\$84.67
	PRICE																																											
1-24	\$40.63																																											
25-49	\$37.79																																											
50-99	\$34.94																																											
100 +	\$32.50																																											
PRICE																																												
1-24	\$75.36																																											
25-49	\$70.08																																											
50-99	\$64.81																																											
100 +	\$60.29																																											
PRICE																																												
1-24	\$104.12																																											
25-49	\$96.83																																											
50-99	\$89.54																																											
100 +	\$83.30																																											
PRICE																																												
1-24	\$105.84																																											
25-49	\$98.43																																											
50-99	\$91.02																																											
100 +	\$84.67																																											
6	 <table border="1"> <thead> <tr> <th colspan="2">PRICE</th> </tr> </thead> <tbody> <tr> <td>1-24</td> <td>\$108.17</td> </tr> <tr> <td>25-49</td> <td>\$100.60</td> </tr> <tr> <td>50-99</td> <td>\$93.03</td> </tr> <tr> <td>100 +</td> <td>\$86.54</td> </tr> </tbody> </table> <p><b>PRECISION</b> Model No: <b>PE9497</b> SMA Male To N Female Panel Mount, Mounting Hole A05 Max VSWR 1.15:1 @ 18 GHz</p>	PRICE		1-24	\$108.17	25-49	\$100.60	50-99	\$93.03	100 +	\$86.54	 <table border="1"> <thead> <tr> <th colspan="2">PRICE</th> </tr> </thead> <tbody> <tr> <td>1-24</td> <td>\$42.66</td> </tr> <tr> <td>25-49</td> <td>\$39.67</td> </tr> <tr> <td>50-99</td> <td>\$36.69</td> </tr> <tr> <td>100 +</td> <td>\$34.13</td> </tr> </tbody> </table> <p><b>PRECISION</b> Model No: <b>PE9082</b> SMA Male To N Female</p>	PRICE		1-24	\$42.66	25-49	\$39.67	50-99	\$36.69	100 +	\$34.13	 <table border="1"> <thead> <tr> <th colspan="2">PRICE</th> </tr> </thead> <tbody> <tr> <td>1-24</td> <td>\$71.33</td> </tr> <tr> <td>25-49</td> <td>\$66.34</td> </tr> <tr> <td>50-99</td> <td>\$61.34</td> </tr> <tr> <td>100 +</td> <td>\$57.06</td> </tr> </tbody> </table> <p><b>PRECISION</b> Model No: <b>PE9105</b> SMA Male To N Female Panel Mount Mounting Hole A05</p>	PRICE		1-24	\$71.33	25-49	\$66.34	50-99	\$61.34	100 +	\$57.06	 <table border="1"> <thead> <tr> <th colspan="2">PRICE</th> </tr> </thead> <tbody> <tr> <td>1-24</td> <td>\$70.88</td> </tr> <tr> <td>25-49</td> <td>\$65.92</td> </tr> <tr> <td>50-99</td> <td>\$60.96</td> </tr> <tr> <td>100 +</td> <td>\$56.70</td> </tr> </tbody> </table> <p><b>PRECISION</b> Model No: <b>PE9430</b> SMA Female To N Male Max VSWR 1.15:1 @ 18 GHz</p>	PRICE		1-24	\$70.88	25-49	\$65.92	50-99	\$60.96	100 +	\$56.70
	PRICE																																											
1-24	\$108.17																																											
25-49	\$100.60																																											
50-99	\$93.03																																											
100 +	\$86.54																																											
PRICE																																												
1-24	\$42.66																																											
25-49	\$39.67																																											
50-99	\$36.69																																											
100 +	\$34.13																																											
PRICE																																												
1-24	\$71.33																																											
25-49	\$66.34																																											
50-99	\$61.34																																											
100 +	\$57.06																																											
PRICE																																												
1-24	\$70.88																																											
25-49	\$65.92																																											
50-99	\$60.96																																											
100 +	\$56.70																																											

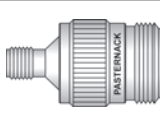

# ADAPTERS

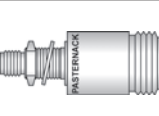
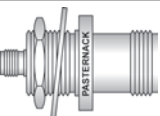
See Adapter Locator on Pages 140-145 or the Adapter Matrix on Pages 138-139

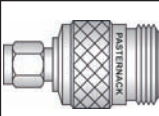
See Page 246 for Mounting Holes

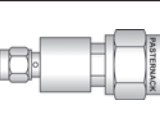
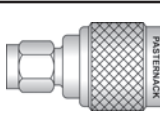
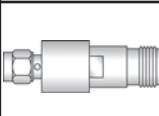
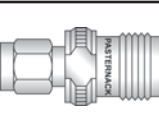
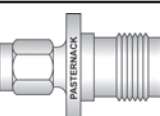
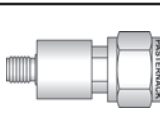
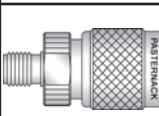
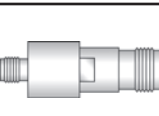
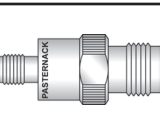
	A	B	C	D																																								
1	 <table border="1"> <thead> <tr> <th colspan="2">PRICE</th> </tr> </thead> <tbody> <tr> <td>1-24</td> <td>\$122.25</td> </tr> <tr> <td>25-49</td> <td>\$113.69</td> </tr> <tr> <td>50-99</td> <td>\$105.14</td> </tr> <tr> <td>100 +</td> <td>\$97.80</td> </tr> </tbody> </table> <p><b>PRECISION</b></p> <p>Model No: <b>PE9498</b></p> <p>SMA Female To N Male Panel Mount, Mounting Hole A05 Max VSWR 1.15:1 @ 18 GHz</p>	PRICE		1-24	\$122.25	25-49	\$113.69	50-99	\$105.14	100 +	\$97.80	 <table border="1"> <thead> <tr> <th colspan="2">PRICE</th> </tr> </thead> <tbody> <tr> <td>1-24</td> <td>\$40.89</td> </tr> <tr> <td>25-49</td> <td>\$38.03</td> </tr> <tr> <td>50-99</td> <td>\$35.17</td> </tr> <tr> <td>100 +</td> <td>\$32.71</td> </tr> </tbody> </table> <p><b>PRECISION</b></p> <p>Model No: <b>PE9081</b></p> <p>SMA Female To N Male</p>	PRICE		1-24	\$40.89	25-49	\$38.03	50-99	\$35.17	100 +	\$32.71	 <table border="1"> <thead> <tr> <th colspan="2">PRICE</th> </tr> </thead> <tbody> <tr> <td>1-24</td> <td>\$117.64</td> </tr> <tr> <td>25-49</td> <td>\$109.41</td> </tr> <tr> <td>50-99</td> <td>\$101.17</td> </tr> <tr> <td>100 +</td> <td>\$94.11</td> </tr> </tbody> </table> <p><b>PRECISION</b></p> <p>Model No: <b>PE9684</b></p> <p>SMA Female To N Male Quick Disconnect</p>	PRICE		1-24	\$117.64	25-49	\$109.41	50-99	\$101.17	100 +	\$94.11	 <table border="1"> <thead> <tr> <th colspan="2">PRICE</th> </tr> </thead> <tbody> <tr> <td>1-24</td> <td>\$50.61</td> </tr> <tr> <td>25-49</td> <td>\$47.07</td> </tr> <tr> <td>50-99</td> <td>\$43.52</td> </tr> <tr> <td>100 +</td> <td>\$40.49</td> </tr> </tbody> </table> <p><b>PRECISION</b></p> <p>Model No: <b>PE9551</b></p> <p>SMA Female Bulkhead To N Male Mounting Hole B09</p>	PRICE		1-24	\$50.61	25-49	\$47.07	50-99	\$43.52	100 +	\$40.49
	PRICE																																											
	1-24	\$122.25																																										
	25-49	\$113.69																																										
	50-99	\$105.14																																										
	100 +	\$97.80																																										
PRICE																																												
1-24	\$40.89																																											
25-49	\$38.03																																											
50-99	\$35.17																																											
100 +	\$32.71																																											
PRICE																																												
1-24	\$117.64																																											
25-49	\$109.41																																											
50-99	\$101.17																																											
100 +	\$94.11																																											
PRICE																																												
1-24	\$50.61																																											
25-49	\$47.07																																											
50-99	\$43.52																																											
100 +	\$40.49																																											
2	 <table border="1"> <thead> <tr> <th colspan="2">PRICE</th> </tr> </thead> <tbody> <tr> <td>1-24</td> <td>\$71.80</td> </tr> <tr> <td>25-49</td> <td>\$66.77</td> </tr> <tr> <td>50-99</td> <td>\$61.75</td> </tr> <tr> <td>100 +</td> <td>\$57.44</td> </tr> </tbody> </table> <p><b>PRECISION</b></p> <p>Model No: <b>PE9275</b></p> <p>SMA Female To N Male Panel Mount Mounting Hole A05</p>	PRICE		1-24	\$71.80	25-49	\$66.77	50-99	\$61.75	100 +	\$57.44	 <table border="1"> <thead> <tr> <th colspan="2">PRICE</th> </tr> </thead> <tbody> <tr> <td>1-24</td> <td>\$71.94</td> </tr> <tr> <td>25-49</td> <td>\$66.90</td> </tr> <tr> <td>50-99</td> <td>\$61.87</td> </tr> <tr> <td>100 +</td> <td>\$57.55</td> </tr> </tbody> </table> <p><b>PRECISION</b></p> <p>Model No: <b>PE9432</b></p> <p>SMA Female To N Female Max VSWR 1.15:1 @ 18 GHz</p>	PRICE		1-24	\$71.94	25-49	\$66.90	50-99	\$61.87	100 +	\$57.55	 <table border="1"> <thead> <tr> <th colspan="2">PRICE</th> </tr> </thead> <tbody> <tr> <td>1-24</td> <td>\$115.67</td> </tr> <tr> <td>25-49</td> <td>\$107.57</td> </tr> <tr> <td>50-99</td> <td>\$99.48</td> </tr> <tr> <td>100 +</td> <td>\$92.54</td> </tr> </tbody> </table> <p><b>PRECISION</b></p> <p>Model No: <b>PE9486</b></p> <p>SMA Female To N Female Bulkhead, Mounting Hole G01 Max VSWR 1.15:1 @ 18 GHz</p>	PRICE		1-24	\$115.67	25-49	\$107.57	50-99	\$99.48	100 +	\$92.54	 <table border="1"> <thead> <tr> <th colspan="2">PRICE</th> </tr> </thead> <tbody> <tr> <td>1-24</td> <td>\$115.67</td> </tr> <tr> <td>25-49</td> <td>\$107.57</td> </tr> <tr> <td>50-99</td> <td>\$99.48</td> </tr> <tr> <td>100 +</td> <td>\$92.54</td> </tr> </tbody> </table> <p><b>PRECISION</b></p> <p>Model No: <b>PE9434</b></p> <p>SMA Female To N Female Panel Mount, Mounting Hole A05 Max VSWR 1.15:1 @ 18 GHz</p>	PRICE		1-24	\$115.67	25-49	\$107.57	50-99	\$99.48	100 +	\$92.54
	PRICE																																											
	1-24	\$71.80																																										
	25-49	\$66.77																																										
	50-99	\$61.75																																										
	100 +	\$57.44																																										
PRICE																																												
1-24	\$71.94																																											
25-49	\$66.90																																											
50-99	\$61.87																																											
100 +	\$57.55																																											
PRICE																																												
1-24	\$115.67																																											
25-49	\$107.57																																											
50-99	\$99.48																																											
100 +	\$92.54																																											
PRICE																																												
1-24	\$115.67																																											
25-49	\$107.57																																											
50-99	\$99.48																																											
100 +	\$92.54																																											
3	 <table border="1"> <thead> <tr> <th colspan="2">PRICE</th> </tr> </thead> <tbody> <tr> <td>1-24</td> <td>\$40.33</td> </tr> <tr> <td>25-49</td> <td>\$37.51</td> </tr> <tr> <td>50-99</td> <td>\$34.68</td> </tr> <tr> <td>100 +</td> <td>\$32.26</td> </tr> </tbody> </table> <p><b>PRECISION</b></p> <p>Model No: <b>PE9083</b></p> <p>SMA Female To N Female</p>	PRICE		1-24	\$40.33	25-49	\$37.51	50-99	\$34.68	100 +	\$32.26	 <table border="1"> <thead> <tr> <th colspan="2">PRICE</th> </tr> </thead> <tbody> <tr> <td>1-24</td> <td>\$38.91</td> </tr> <tr> <td>25-49</td> <td>\$36.19</td> </tr> <tr> <td>50-99</td> <td>\$33.46</td> </tr> <tr> <td>100 +</td> <td>\$31.13</td> </tr> </tbody> </table> <p><b>PRECISION</b></p> <p>Model No: <b>PE9252</b></p> <p>SMA Female To N Female Bulkhead Mounting Hole G01</p>	PRICE		1-24	\$38.91	25-49	\$36.19	50-99	\$33.46	100 +	\$31.13	 <table border="1"> <thead> <tr> <th colspan="2">PRICE</th> </tr> </thead> <tbody> <tr> <td>1-24</td> <td>\$50.72</td> </tr> <tr> <td>25-49</td> <td>\$47.17</td> </tr> <tr> <td>50-99</td> <td>\$43.62</td> </tr> <tr> <td>100 +</td> <td>\$40.58</td> </tr> </tbody> </table> <p><b>PRECISION</b></p> <p>Model No: <b>PE9408</b></p> <p>SMA Female Bulkhead To N Female, Nut On SMA Mounting Hole B09</p>	PRICE		1-24	\$50.72	25-49	\$47.17	50-99	\$43.62	100 +	\$40.58	 <table border="1"> <thead> <tr> <th colspan="2">PRICE</th> </tr> </thead> <tbody> <tr> <td>1-24</td> <td>\$113.29</td> </tr> <tr> <td>25-49</td> <td>\$105.36</td> </tr> <tr> <td>50-99</td> <td>\$97.43</td> </tr> <tr> <td>100 +</td> <td>\$90.63</td> </tr> </tbody> </table> <p><b>PRECISION</b></p> <p>Model No: <b>PE9435</b></p> <p>SMA Female Bulkhead To N Female, Nut On SMA Max VSWR 1.15:1 @ 18 GHz Mounting Hole G01</p>	PRICE		1-24	\$113.29	25-49	\$105.36	50-99	\$97.43	100 +	\$90.63
	PRICE																																											
	1-24	\$40.33																																										
	25-49	\$37.51																																										
	50-99	\$34.68																																										
	100 +	\$32.26																																										
PRICE																																												
1-24	\$38.91																																											
25-49	\$36.19																																											
50-99	\$33.46																																											
100 +	\$31.13																																											
PRICE																																												
1-24	\$50.72																																											
25-49	\$47.17																																											
50-99	\$43.62																																											
100 +	\$40.58																																											
PRICE																																												
1-24	\$113.29																																											
25-49	\$105.36																																											
50-99	\$97.43																																											
100 +	\$90.63																																											
4	 <table border="1"> <thead> <tr> <th colspan="2">PRICE</th> </tr> </thead> <tbody> <tr> <td>1-24</td> <td>\$46.76</td> </tr> <tr> <td>25-49</td> <td>\$43.49</td> </tr> <tr> <td>50-99</td> <td>\$40.21</td> </tr> <tr> <td>100 +</td> <td>\$37.41</td> </tr> </tbody> </table> <p><b>PRECISION</b></p> <p>Model No: <b>PE9104</b></p> <p>SMA Female To N Female Panel Mount Mounting Hole A05</p>	PRICE		1-24	\$46.76	25-49	\$43.49	50-99	\$40.21	100 +	\$37.41	 <table border="1"> <thead> <tr> <th colspan="2">PRICE</th> </tr> </thead> <tbody> <tr> <td>1-24</td> <td>\$56.80</td> </tr> <tr> <td>25-49</td> <td>\$52.82</td> </tr> <tr> <td>50-99</td> <td>\$48.85</td> </tr> <tr> <td>100 +</td> <td>\$45.44</td> </tr> </tbody> </table> <p><b>PRECISION</b></p> <p>Model No: <b>PE9732</b></p> <p>Reverse Polarity SMA Male To N Female</p>	PRICE		1-24	\$56.80	25-49	\$52.82	50-99	\$48.85	100 +	\$45.44	 <table border="1"> <thead> <tr> <th colspan="2">PRICE</th> </tr> </thead> <tbody> <tr> <td>1-24</td> <td>\$56.80</td> </tr> <tr> <td>25-49</td> <td>\$52.82</td> </tr> <tr> <td>50-99</td> <td>\$48.85</td> </tr> <tr> <td>100 +</td> <td>\$45.44</td> </tr> </tbody> </table> <p><b>PRECISION</b></p> <p>Model No: <b>PE9733</b></p> <p>Reverse Polarity SMA Female To N Male</p>	PRICE		1-24	\$56.80	25-49	\$52.82	50-99	\$48.85	100 +	\$45.44	 <table border="1"> <thead> <tr> <th colspan="2">PRICE</th> </tr> </thead> <tbody> <tr> <td>1-24</td> <td>\$86.79</td> </tr> <tr> <td>25-49</td> <td>\$80.71</td> </tr> <tr> <td>50-99</td> <td>\$74.64</td> </tr> <tr> <td>100 +</td> <td>\$69.43</td> </tr> </tbody> </table> <p><b>PRECISION</b></p> <p>Model No: <b>PE9439</b></p> <p>SMA Male To TNC Male Max VSWR 1.25:1 @ 18 GHz</p>	PRICE		1-24	\$86.79	25-49	\$80.71	50-99	\$74.64	100 +	\$69.43
	PRICE																																											
	1-24	\$46.76																																										
	25-49	\$43.49																																										
	50-99	\$40.21																																										
	100 +	\$37.41																																										
PRICE																																												
1-24	\$56.80																																											
25-49	\$52.82																																											
50-99	\$48.85																																											
100 +	\$45.44																																											
PRICE																																												
1-24	\$56.80																																											
25-49	\$52.82																																											
50-99	\$48.85																																											
100 +	\$45.44																																											
PRICE																																												
1-24	\$86.79																																											
25-49	\$80.71																																											
50-99	\$74.64																																											
100 +	\$69.43																																											
5	 <table border="1"> <thead> <tr> <th colspan="2">PRICE</th> </tr> </thead> <tbody> <tr> <td>1-24</td> <td>\$33.49</td> </tr> <tr> <td>25-49</td> <td>\$31.15</td> </tr> <tr> <td>50-99</td> <td>\$28.80</td> </tr> <tr> <td>100 +</td> <td>\$26.79</td> </tr> </tbody> </table> <p><b>PRECISION</b></p> <p>Model No: <b>PE9076</b></p> <p>SMA Male To TNC Male</p>	PRICE		1-24	\$33.49	25-49	\$31.15	50-99	\$28.80	100 +	\$26.79	 <table border="1"> <thead> <tr> <th colspan="2">PRICE</th> </tr> </thead> <tbody> <tr> <td>1-24</td> <td>\$89.85</td> </tr> <tr> <td>25-49</td> <td>\$83.56</td> </tr> <tr> <td>50-99</td> <td>\$77.27</td> </tr> <tr> <td>100 +</td> <td>\$71.88</td> </tr> </tbody> </table> <p><b>PRECISION</b></p> <p>Model No: <b>PE9441</b></p> <p>SMA Male To TNC Female Max VSWR 1.25:1 @ 18 GHz</p>	PRICE		1-24	\$89.85	25-49	\$83.56	50-99	\$77.27	100 +	\$71.88	 <table border="1"> <thead> <tr> <th colspan="2">PRICE</th> </tr> </thead> <tbody> <tr> <td>1-24</td> <td>\$34.65</td> </tr> <tr> <td>25-49</td> <td>\$32.22</td> </tr> <tr> <td>50-99</td> <td>\$29.80</td> </tr> <tr> <td>100 +</td> <td>\$27.72</td> </tr> </tbody> </table> <p><b>PRECISION</b></p> <p>Model No: <b>PE9078</b></p> <p>SMA Male To TNC Female</p>	PRICE		1-24	\$34.65	25-49	\$32.22	50-99	\$29.80	100 +	\$27.72	 <table border="1"> <thead> <tr> <th colspan="2">PRICE</th> </tr> </thead> <tbody> <tr> <td>1-24</td> <td>\$50.46</td> </tr> <tr> <td>25-49</td> <td>\$46.93</td> </tr> <tr> <td>50-99</td> <td>\$43.40</td> </tr> <tr> <td>100 +</td> <td>\$40.37</td> </tr> </tbody> </table> <p><b>PRECISION</b></p> <p>Model No: <b>PE9384</b></p> <p>SMA Male To TNC Female Panel Mount Mounting Hole A09</p>	PRICE		1-24	\$50.46	25-49	\$46.93	50-99	\$43.40	100 +	\$40.37
	PRICE																																											
	1-24	\$33.49																																										
	25-49	\$31.15																																										
	50-99	\$28.80																																										
	100 +	\$26.79																																										
PRICE																																												
1-24	\$89.85																																											
25-49	\$83.56																																											
50-99	\$77.27																																											
100 +	\$71.88																																											
PRICE																																												
1-24	\$34.65																																											
25-49	\$32.22																																											
50-99	\$29.80																																											
100 +	\$27.72																																											
PRICE																																												
1-24	\$50.46																																											
25-49	\$46.93																																											
50-99	\$43.40																																											
100 +	\$40.37																																											
6	 <table border="1"> <thead> <tr> <th colspan="2">PRICE</th> </tr> </thead> <tbody> <tr> <td>1-24</td> <td>\$85.88</td> </tr> <tr> <td>25-49</td> <td>\$79.87</td> </tr> <tr> <td>50-99</td> <td>\$73.86</td> </tr> <tr> <td>100 +</td> <td>\$68.70</td> </tr> </tbody> </table> <p><b>PRECISION</b></p> <p>Model No: <b>PE9440</b></p> <p>SMA Female To TNC Male Max VSWR 1.25:1 @ 18 GHz</p>	PRICE		1-24	\$85.88	25-49	\$79.87	50-99	\$73.86	100 +	\$68.70	 <table border="1"> <thead> <tr> <th colspan="2">PRICE</th> </tr> </thead> <tbody> <tr> <td>1-24</td> <td>\$36.35</td> </tr> <tr> <td>25-49</td> <td>\$33.81</td> </tr> <tr> <td>50-99</td> <td>\$31.26</td> </tr> <tr> <td>100 +</td> <td>\$29.08</td> </tr> </tbody> </table> <p><b>PRECISION</b></p> <p>Model No: <b>PE9077</b></p> <p>SMA Female To TNC Male</p>	PRICE		1-24	\$36.35	25-49	\$33.81	50-99	\$31.26	100 +	\$29.08	 <table border="1"> <thead> <tr> <th colspan="2">PRICE</th> </tr> </thead> <tbody> <tr> <td>1-24</td> <td>\$92.56</td> </tr> <tr> <td>25-49</td> <td>\$86.08</td> </tr> <tr> <td>50-99</td> <td>\$79.60</td> </tr> <tr> <td>100 +</td> <td>\$74.05</td> </tr> </tbody> </table> <p><b>PRECISION</b></p> <p>Model No: <b>PE9442</b></p> <p>SMA Female To TNC Female Max VSWR 1.25:1 @ 18 GHz</p>	PRICE		1-24	\$92.56	25-49	\$86.08	50-99	\$79.60	100 +	\$74.05	 <table border="1"> <thead> <tr> <th colspan="2">PRICE</th> </tr> </thead> <tbody> <tr> <td>1-24</td> <td>\$36.24</td> </tr> <tr> <td>25-49</td> <td>\$33.70</td> </tr> <tr> <td>50-99</td> <td>\$31.17</td> </tr> <tr> <td>100 +</td> <td>\$28.99</td> </tr> </tbody> </table> <p><b>PRECISION</b></p> <p>Model No: <b>PE9079</b></p> <p>SMA Female To TNC Female</p>	PRICE		1-24	\$36.24	25-49	\$33.70	50-99	\$31.17	100 +	\$28.99
	PRICE																																											
	1-24	\$85.88																																										
	25-49	\$79.87																																										
	50-99	\$73.86																																										
	100 +	\$68.70																																										
PRICE																																												
1-24	\$36.35																																											
25-49	\$33.81																																											
50-99	\$31.26																																											
100 +	\$29.08																																											
PRICE																																												
1-24	\$92.56																																											
25-49	\$86.08																																											
50-99	\$79.60																																											
100 +	\$74.05																																											
PRICE																																												
1-24	\$36.24																																											
25-49	\$33.70																																											
50-99	\$31.17																																											
100 +	\$28.99																																											

Adapters











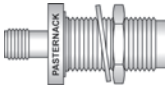

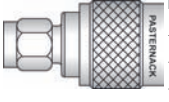

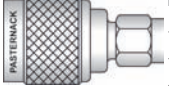
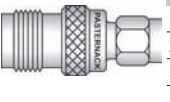
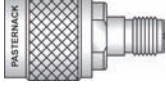
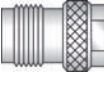
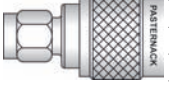
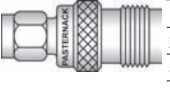

See Our Website For Real-Time Stock Availability!

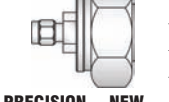

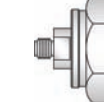
# ADAPTERS

See Adapter Locator on Pages 140-145 or the Adapter Matrix on Pages 138-139

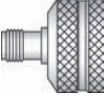
See Page 246 for Mounting Holes

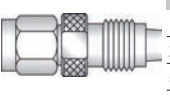
	A	B	C	D																																								
1	 <table border="1"> <thead> <tr> <th colspan="2">PRICE</th> </tr> </thead> <tbody> <tr> <td>1-24</td> <td>\$39.86</td> </tr> <tr> <td>25-49</td> <td>\$37.07</td> </tr> <tr> <td>50-99</td> <td>\$34.28</td> </tr> <tr> <td>100 +</td> <td>\$31.89</td> </tr> </tbody> </table> <p><b>Model No: PE9251</b> SMA Female To TNC Female Bulkhead Mounting Hole B05</p>	PRICE		1-24	\$39.86	25-49	\$37.07	50-99	\$34.28	100 +	\$31.89	 <table border="1"> <thead> <tr> <th colspan="2">PRICE</th> </tr> </thead> <tbody> <tr> <td>1-24</td> <td>\$39.67</td> </tr> <tr> <td>25-49</td> <td>\$36.89</td> </tr> <tr> <td>50-99</td> <td>\$34.12</td> </tr> <tr> <td>100 +</td> <td>\$31.74</td> </tr> </tbody> </table> <p><b>Model No: PE9276</b> SMA Female To TNC Female Panel Mount Mounting Hole A03</p>	PRICE		1-24	\$39.67	25-49	\$36.89	50-99	\$34.12	100 +	\$31.74	 <table border="1"> <thead> <tr> <th colspan="2">PRICE</th> </tr> </thead> <tbody> <tr> <td>1-24</td> <td>\$45.75</td> </tr> <tr> <td>25-49</td> <td>\$42.55</td> </tr> <tr> <td>50-99</td> <td>\$39.35</td> </tr> <tr> <td>100 +</td> <td>\$36.60</td> </tr> </tbody> </table> <p><b>Model No: PE9601</b> SMA Male To Reverse Polarity TNC Male</p>	PRICE		1-24	\$45.75	25-49	\$42.55	50-99	\$39.35	100 +	\$36.60	 <table border="1"> <thead> <tr> <th colspan="2">PRICE</th> </tr> </thead> <tbody> <tr> <td>1-24</td> <td>\$39.97</td> </tr> <tr> <td>25-49</td> <td>\$37.17</td> </tr> <tr> <td>50-99</td> <td>\$34.37</td> </tr> <tr> <td>100 +</td> <td>\$31.98</td> </tr> </tbody> </table> <p><b>Model No: PE9600</b> SMA Male To Reverse Polarity TNC Female</p>	PRICE		1-24	\$39.97	25-49	\$37.17	50-99	\$34.37	100 +	\$31.98
PRICE																																												
1-24	\$39.86																																											
25-49	\$37.07																																											
50-99	\$34.28																																											
100 +	\$31.89																																											
PRICE																																												
1-24	\$39.67																																											
25-49	\$36.89																																											
50-99	\$34.12																																											
100 +	\$31.74																																											
PRICE																																												
1-24	\$45.75																																											
25-49	\$42.55																																											
50-99	\$39.35																																											
100 +	\$36.60																																											
PRICE																																												
1-24	\$39.97																																											
25-49	\$37.17																																											
50-99	\$34.37																																											
100 +	\$31.98																																											
2	 <table border="1"> <thead> <tr> <th colspan="2">PRICE</th> </tr> </thead> <tbody> <tr> <td>1-24</td> <td>\$40.63</td> </tr> <tr> <td>25-49</td> <td>\$37.79</td> </tr> <tr> <td>50-99</td> <td>\$34.94</td> </tr> <tr> <td>100 +</td> <td>\$32.50</td> </tr> </tbody> </table> <p><b>Model No: PE9602</b> SMA Female To Reverse Polarity TNC Male</p>	PRICE		1-24	\$40.63	25-49	\$37.79	50-99	\$34.94	100 +	\$32.50	 <table border="1"> <thead> <tr> <th colspan="2">PRICE</th> </tr> </thead> <tbody> <tr> <td>1-24</td> <td>\$50.06</td> </tr> <tr> <td>25-49</td> <td>\$46.56</td> </tr> <tr> <td>50-99</td> <td>\$43.05</td> </tr> <tr> <td>100 +</td> <td>\$40.05</td> </tr> </tbody> </table> <p><b>Model No: PE9603</b> SMA Female To Reverse Polarity TNC Female</p>	PRICE		1-24	\$50.06	25-49	\$46.56	50-99	\$43.05	100 +	\$40.05	 <table border="1"> <thead> <tr> <th colspan="2">PRICE</th> </tr> </thead> <tbody> <tr> <td>1-24</td> <td>\$47.12</td> </tr> <tr> <td>25-49</td> <td>\$43.82</td> </tr> <tr> <td>50-99</td> <td>\$40.52</td> </tr> <tr> <td>100 +</td> <td>\$37.70</td> </tr> </tbody> </table> <p><b>Model No: PE9597</b> Reverse Polarity SMA Male To TNC Male</p>	PRICE		1-24	\$47.12	25-49	\$43.82	50-99	\$40.52	100 +	\$37.70	 <table border="1"> <thead> <tr> <th colspan="2">PRICE</th> </tr> </thead> <tbody> <tr> <td>1-24</td> <td>\$46.21</td> </tr> <tr> <td>25-49</td> <td>\$42.98</td> </tr> <tr> <td>50-99</td> <td>\$39.74</td> </tr> <tr> <td>100 +</td> <td>\$36.97</td> </tr> </tbody> </table> <p><b>Model No: PE9596</b> Reverse Polarity SMA Male To TNC Female</p>	PRICE		1-24	\$46.21	25-49	\$42.98	50-99	\$39.74	100 +	\$36.97
PRICE																																												
1-24	\$40.63																																											
25-49	\$37.79																																											
50-99	\$34.94																																											
100 +	\$32.50																																											
PRICE																																												
1-24	\$50.06																																											
25-49	\$46.56																																											
50-99	\$43.05																																											
100 +	\$40.05																																											
PRICE																																												
1-24	\$47.12																																											
25-49	\$43.82																																											
50-99	\$40.52																																											
100 +	\$37.70																																											
PRICE																																												
1-24	\$46.21																																											
25-49	\$42.98																																											
50-99	\$39.74																																											
100 +	\$36.97																																											
3	 <table border="1"> <thead> <tr> <th colspan="2">PRICE</th> </tr> </thead> <tbody> <tr> <td>1-24</td> <td>\$46.21</td> </tr> <tr> <td>25-49</td> <td>\$42.98</td> </tr> <tr> <td>50-99</td> <td>\$39.74</td> </tr> <tr> <td>100 +</td> <td>\$36.97</td> </tr> </tbody> </table> <p><b>Model No: PE9598</b> Reverse Polarity SMA Female To TNC Male</p>	PRICE		1-24	\$46.21	25-49	\$42.98	50-99	\$39.74	100 +	\$36.97	 <table border="1"> <thead> <tr> <th colspan="2">PRICE</th> </tr> </thead> <tbody> <tr> <td>1-24</td> <td>\$47.12</td> </tr> <tr> <td>25-49</td> <td>\$43.82</td> </tr> <tr> <td>50-99</td> <td>\$40.52</td> </tr> <tr> <td>100 +</td> <td>\$37.70</td> </tr> </tbody> </table> <p><b>Model No: PE9599</b> Reverse Polarity SMA Female To TNC Female</p>	PRICE		1-24	\$47.12	25-49	\$43.82	50-99	\$40.52	100 +	\$37.70	 <table border="1"> <thead> <tr> <th colspan="2">PRICE</th> </tr> </thead> <tbody> <tr> <td>1-24</td> <td>\$47.12</td> </tr> <tr> <td>25-49</td> <td>\$43.82</td> </tr> <tr> <td>50-99</td> <td>\$40.52</td> </tr> <tr> <td>100 +</td> <td>\$37.70</td> </tr> </tbody> </table> <p><b>Model No: PE9605</b> Reverse Polarity SMA Male To Reverse Polarity TNC Male</p>	PRICE		1-24	\$47.12	25-49	\$43.82	50-99	\$40.52	100 +	\$37.70	 <table border="1"> <thead> <tr> <th colspan="2">PRICE</th> </tr> </thead> <tbody> <tr> <td>1-24</td> <td>\$55.28</td> </tr> <tr> <td>25-49</td> <td>\$51.41</td> </tr> <tr> <td>50-99</td> <td>\$47.54</td> </tr> <tr> <td>100 +</td> <td>\$44.22</td> </tr> </tbody> </table> <p><b>Model No: PE9604</b> Reverse Polarity SMA Male To Reverse Polarity TNC Female</p>	PRICE		1-24	\$55.28	25-49	\$51.41	50-99	\$47.54	100 +	\$44.22
PRICE																																												
1-24	\$46.21																																											
25-49	\$42.98																																											
50-99	\$39.74																																											
100 +	\$36.97																																											
PRICE																																												
1-24	\$47.12																																											
25-49	\$43.82																																											
50-99	\$40.52																																											
100 +	\$37.70																																											
PRICE																																												
1-24	\$47.12																																											
25-49	\$43.82																																											
50-99	\$40.52																																											
100 +	\$37.70																																											
PRICE																																												
1-24	\$55.28																																											
25-49	\$51.41																																											
50-99	\$47.54																																											
100 +	\$44.22																																											
4	 <table border="1"> <thead> <tr> <th colspan="2">PRICE</th> </tr> </thead> <tbody> <tr> <td>1-24</td> <td>\$47.12</td> </tr> <tr> <td>25-49</td> <td>\$43.82</td> </tr> <tr> <td>50-99</td> <td>\$40.52</td> </tr> <tr> <td>100 +</td> <td>\$37.70</td> </tr> </tbody> </table> <p><b>Model No: PE9607</b> Reverse Polarity SMA Female To Reverse Polarity TNC Male</p>	PRICE		1-24	\$47.12	25-49	\$43.82	50-99	\$40.52	100 +	\$37.70	 <table border="1"> <thead> <tr> <th colspan="2">PRICE</th> </tr> </thead> <tbody> <tr> <td>1-24</td> <td>\$47.12</td> </tr> <tr> <td>25-49</td> <td>\$43.82</td> </tr> <tr> <td>50-99</td> <td>\$40.52</td> </tr> <tr> <td>100 +</td> <td>\$37.70</td> </tr> </tbody> </table> <p><b>Model No: PE9606</b> Reverse Polarity SMA Female To Reverse Polarity TNC Female</p>	PRICE		1-24	\$47.12	25-49	\$43.82	50-99	\$40.52	100 +	\$37.70	 <table border="1"> <thead> <tr> <th colspan="2">PRICE</th> </tr> </thead> <tbody> <tr> <td>1-24</td> <td>\$75.00</td> </tr> <tr> <td>25-49</td> <td>\$69.75</td> </tr> <tr> <td>50-99</td> <td>\$64.50</td> </tr> <tr> <td>100 +</td> <td>\$60.00</td> </tr> </tbody> </table> <p><b>Model No: PE91043</b> SMA Male To 7/16 Male Low PIM, Low VSWR</p>	PRICE		1-24	\$75.00	25-49	\$69.75	50-99	\$64.50	100 +	\$60.00	 <table border="1"> <thead> <tr> <th colspan="2">PRICE</th> </tr> </thead> <tbody> <tr> <td>1-24</td> <td>\$68.00</td> </tr> <tr> <td>25-49</td> <td>\$63.24</td> </tr> <tr> <td>50-99</td> <td>\$58.48</td> </tr> <tr> <td>100 +</td> <td>\$54.40</td> </tr> </tbody> </table> <p><b>Model No: PE91041</b> SMA Male To 7/16 Female Low PIM, Low VSWR</p>	PRICE		1-24	\$68.00	25-49	\$63.24	50-99	\$58.48	100 +	\$54.40
PRICE																																												
1-24	\$47.12																																											
25-49	\$43.82																																											
50-99	\$40.52																																											
100 +	\$37.70																																											
PRICE																																												
1-24	\$47.12																																											
25-49	\$43.82																																											
50-99	\$40.52																																											
100 +	\$37.70																																											
PRICE																																												
1-24	\$75.00																																											
25-49	\$69.75																																											
50-99	\$64.50																																											
100 +	\$60.00																																											
PRICE																																												
1-24	\$68.00																																											
25-49	\$63.24																																											
50-99	\$58.48																																											
100 +	\$54.40																																											
5	 <table border="1"> <thead> <tr> <th colspan="2">PRICE</th> </tr> </thead> <tbody> <tr> <td>1-24</td> <td>\$94.08</td> </tr> <tr> <td>25-49</td> <td>\$87.49</td> </tr> <tr> <td>50-99</td> <td>\$80.91</td> </tr> <tr> <td>100 +</td> <td>\$75.26</td> </tr> </tbody> </table> <p><b>Model No: PE9411</b> SMA Male To 7/16 Female</p>	PRICE		1-24	\$94.08	25-49	\$87.49	50-99	\$80.91	100 +	\$75.26	 <table border="1"> <thead> <tr> <th colspan="2">PRICE</th> </tr> </thead> <tbody> <tr> <td>1-24</td> <td>\$65.00</td> </tr> <tr> <td>25-49</td> <td>\$60.45</td> </tr> <tr> <td>50-99</td> <td>\$55.90</td> </tr> <tr> <td>100 +</td> <td>\$52.00</td> </tr> </tbody> </table> <p><b>Model No: PE91036</b> SMA Female To 7/16 Male Low PIM, Low VSWR</p>	PRICE		1-24	\$65.00	25-49	\$60.45	50-99	\$55.90	100 +	\$52.00	 <table border="1"> <thead> <tr> <th colspan="2">PRICE</th> </tr> </thead> <tbody> <tr> <td>1-24</td> <td>\$94.08</td> </tr> <tr> <td>25-49</td> <td>\$87.49</td> </tr> <tr> <td>50-99</td> <td>\$80.91</td> </tr> <tr> <td>100 +</td> <td>\$75.26</td> </tr> </tbody> </table> <p><b>Model No: PE9412</b> SMA Female To 7/16 Male</p>	PRICE		1-24	\$94.08	25-49	\$87.49	50-99	\$80.91	100 +	\$75.26	 <table border="1"> <thead> <tr> <th colspan="2">PRICE</th> </tr> </thead> <tbody> <tr> <td>1-24</td> <td>\$65.00</td> </tr> <tr> <td>25-49</td> <td>\$60.45</td> </tr> <tr> <td>50-99</td> <td>\$55.90</td> </tr> <tr> <td>100 +</td> <td>\$52.00</td> </tr> </tbody> </table> <p><b>Model No: PE91042</b> SMA Female To 7/16 Female Low PIM, Low VSWR</p>	PRICE		1-24	\$65.00	25-49	\$60.45	50-99	\$55.90	100 +	\$52.00
PRICE																																												
1-24	\$94.08																																											
25-49	\$87.49																																											
50-99	\$80.91																																											
100 +	\$75.26																																											
PRICE																																												
1-24	\$65.00																																											
25-49	\$60.45																																											
50-99	\$55.90																																											
100 +	\$52.00																																											
PRICE																																												
1-24	\$94.08																																											
25-49	\$87.49																																											
50-99	\$80.91																																											
100 +	\$75.26																																											
PRICE																																												
1-24	\$65.00																																											
25-49	\$60.45																																											
50-99	\$55.90																																											
100 +	\$52.00																																											
6	 <table border="1"> <thead> <tr> <th colspan="2">PRICE</th> </tr> </thead> <tbody> <tr> <td>1-24</td> <td>\$31.92</td> </tr> <tr> <td>25-49</td> <td>\$29.69</td> </tr> <tr> <td>50-99</td> <td>\$27.45</td> </tr> <tr> <td>100 +</td> <td>\$25.54</td> </tr> </tbody> </table> <p><b>Model No: PE9400</b> SMA Male To UHF Female</p>	PRICE		1-24	\$31.92	25-49	\$29.69	50-99	\$27.45	100 +	\$25.54	 <table border="1"> <thead> <tr> <th colspan="2">PRICE</th> </tr> </thead> <tbody> <tr> <td>1-24</td> <td>\$38.71</td> </tr> <tr> <td>25-49</td> <td>\$36.00</td> </tr> <tr> <td>50-99</td> <td>\$33.29</td> </tr> <tr> <td>100 +</td> <td>\$30.97</td> </tr> </tbody> </table> <p><b>Model No: PE9415</b> SMA Female To UHF Male</p>	PRICE		1-24	\$38.71	25-49	\$36.00	50-99	\$33.29	100 +	\$30.97	 <table border="1"> <thead> <tr> <th colspan="2">PRICE</th> </tr> </thead> <tbody> <tr> <td>1-24</td> <td>\$11.50</td> </tr> <tr> <td>25-49</td> <td>\$10.70</td> </tr> <tr> <td>50-99</td> <td>\$9.89</td> </tr> <tr> <td>100 +</td> <td>\$9.20</td> </tr> </tbody> </table> <p><b>Model No: PE9702</b> SMA Male To FME Plug</p>	PRICE		1-24	\$11.50	25-49	\$10.70	50-99	\$9.89	100 +	\$9.20	 <table border="1"> <thead> <tr> <th colspan="2">PRICE</th> </tr> </thead> <tbody> <tr> <td>1-24</td> <td>\$12.72</td> </tr> <tr> <td>25-49</td> <td>\$11.83</td> </tr> <tr> <td>50-99</td> <td>\$10.94</td> </tr> <tr> <td>100 +</td> <td>\$10.18</td> </tr> </tbody> </table> <p><b>Model No: PE9707</b> SMA Male To FME Jack</p>	PRICE		1-24	\$12.72	25-49	\$11.83	50-99	\$10.94	100 +	\$10.18
PRICE																																												
1-24	\$31.92																																											
25-49	\$29.69																																											
50-99	\$27.45																																											
100 +	\$25.54																																											
PRICE																																												
1-24	\$38.71																																											
25-49	\$36.00																																											
50-99	\$33.29																																											
100 +	\$30.97																																											
PRICE																																												
1-24	\$11.50																																											
25-49	\$10.70																																											
50-99	\$9.89																																											
100 +	\$9.20																																											
PRICE																																												
1-24	\$12.72																																											
25-49	\$11.83																																											
50-99	\$10.94																																											
100 +	\$10.18																																											











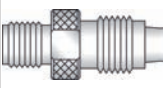
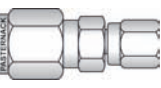
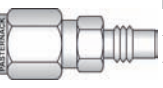

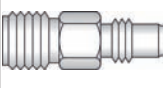
Adapters

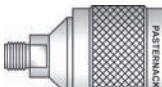
See Our Website For Real-Time Stock Availability!

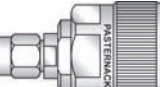
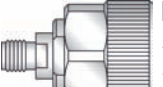
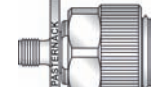
# ADAPTERS

See Adapter Locator on Pages 140-145 or the Adapter Matrix on Pages 138-139

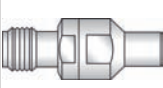
See Page 246 for Mounting Holes

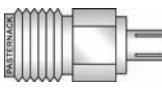
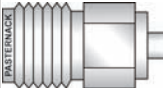
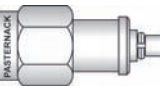
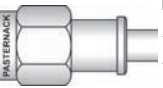
	A	B	C	D																																								
1	 <table border="1"> <thead> <tr> <th colspan="2">PRICE</th> </tr> </thead> <tbody> <tr> <td>1-24</td> <td>\$11.70</td> </tr> <tr> <td>25-49</td> <td>\$10.88</td> </tr> <tr> <td>50-99</td> <td>\$10.06</td> </tr> <tr> <td>100 +</td> <td>\$9.36</td> </tr> </tbody> </table>	PRICE		1-24	\$11.70	25-49	\$10.88	50-99	\$10.06	100 +	\$9.36	 <table border="1"> <thead> <tr> <th colspan="2">PRICE</th> </tr> </thead> <tbody> <tr> <td>1-24</td> <td>\$13.88</td> </tr> <tr> <td>25-49</td> <td>\$12.91</td> </tr> <tr> <td>50-99</td> <td>\$11.94</td> </tr> <tr> <td>100 +</td> <td>\$11.10</td> </tr> </tbody> </table>	PRICE		1-24	\$13.88	25-49	\$12.91	50-99	\$11.94	100 +	\$11.10	 <table border="1"> <thead> <tr> <th colspan="2">PRICE</th> </tr> </thead> <tbody> <tr> <td>1-24</td> <td>\$39.32</td> </tr> <tr> <td>25-49</td> <td>\$36.57</td> </tr> <tr> <td>50-99</td> <td>\$33.82</td> </tr> <tr> <td>100 +</td> <td>\$31.46</td> </tr> </tbody> </table>	PRICE		1-24	\$39.32	25-49	\$36.57	50-99	\$33.82	100 +	\$31.46	 <table border="1"> <thead> <tr> <th colspan="2">PRICE</th> </tr> </thead> <tbody> <tr> <td>1-24</td> <td>\$40.07</td> </tr> <tr> <td>25-49</td> <td>\$37.27</td> </tr> <tr> <td>50-99</td> <td>\$34.46</td> </tr> <tr> <td>100 +</td> <td>\$32.06</td> </tr> </tbody> </table>	PRICE		1-24	\$40.07	25-49	\$37.27	50-99	\$34.46	100 +	\$32.06
	PRICE																																											
1-24	\$11.70																																											
25-49	\$10.88																																											
50-99	\$10.06																																											
100 +	\$9.36																																											
PRICE																																												
1-24	\$13.88																																											
25-49	\$12.91																																											
50-99	\$11.94																																											
100 +	\$11.10																																											
PRICE																																												
1-24	\$39.32																																											
25-49	\$36.57																																											
50-99	\$33.82																																											
100 +	\$31.46																																											
PRICE																																												
1-24	\$40.07																																											
25-49	\$37.27																																											
50-99	\$34.46																																											
100 +	\$32.06																																											
	<b>Model No: PE9703</b> SMA Female To FME Plug	<b>Model No: PE9708</b> SMA Female To FME Jack	<b>Model No: PE9148</b> SMA Male To SMC Plug	<b>Model No: PE9149</b> SMA Male To SMC Jack																																								
2	 <table border="1"> <thead> <tr> <th colspan="2">PRICE</th> </tr> </thead> <tbody> <tr> <td>1-24</td> <td>\$42.86</td> </tr> <tr> <td>25-49</td> <td>\$39.86</td> </tr> <tr> <td>50-99</td> <td>\$36.86</td> </tr> <tr> <td>100 +</td> <td>\$34.29</td> </tr> </tbody> </table>	PRICE		1-24	\$42.86	25-49	\$39.86	50-99	\$36.86	100 +	\$34.29	 <table border="1"> <thead> <tr> <th colspan="2">PRICE</th> </tr> </thead> <tbody> <tr> <td>1-24</td> <td>\$40.07</td> </tr> <tr> <td>25-49</td> <td>\$37.27</td> </tr> <tr> <td>50-99</td> <td>\$34.46</td> </tr> <tr> <td>100 +</td> <td>\$32.06</td> </tr> </tbody> </table>	PRICE		1-24	\$40.07	25-49	\$37.27	50-99	\$34.46	100 +	\$32.06	 <table border="1"> <thead> <tr> <th colspan="2">PRICE</th> </tr> </thead> <tbody> <tr> <td>1-24</td> <td>\$58.87</td> </tr> <tr> <td>25-49</td> <td>\$54.75</td> </tr> <tr> <td>50-99</td> <td>\$50.63</td> </tr> <tr> <td>100 +</td> <td>\$47.10</td> </tr> </tbody> </table>	PRICE		1-24	\$58.87	25-49	\$54.75	50-99	\$50.63	100 +	\$47.10	 <table border="1"> <thead> <tr> <th colspan="2">PRICE</th> </tr> </thead> <tbody> <tr> <td>1-24</td> <td>\$76.40</td> </tr> <tr> <td>25-49</td> <td>\$71.05</td> </tr> <tr> <td>50-99</td> <td>\$65.70</td> </tr> <tr> <td>100 +</td> <td>\$61.12</td> </tr> </tbody> </table>	PRICE		1-24	\$76.40	25-49	\$71.05	50-99	\$65.70	100 +	\$61.12
	PRICE																																											
1-24	\$42.86																																											
25-49	\$39.86																																											
50-99	\$36.86																																											
100 +	\$34.29																																											
PRICE																																												
1-24	\$40.07																																											
25-49	\$37.27																																											
50-99	\$34.46																																											
100 +	\$32.06																																											
PRICE																																												
1-24	\$58.87																																											
25-49	\$54.75																																											
50-99	\$50.63																																											
100 +	\$47.10																																											
PRICE																																												
1-24	\$76.40																																											
25-49	\$71.05																																											
50-99	\$65.70																																											
100 +	\$61.12																																											
	<b>Model No: PE9146</b> SMA Female To SMC Plug	<b>Model No: PE9147</b> SMA Female To SMC Jack	<b>Model No: PE9254</b> SMA Male To HN Male	<b>Model No: PE9256</b> SMA Male To HN Female																																								
3	 <table border="1"> <thead> <tr> <th colspan="2">PRICE</th> </tr> </thead> <tbody> <tr> <td>1-24</td> <td>\$58.87</td> </tr> <tr> <td>25-49</td> <td>\$54.75</td> </tr> <tr> <td>50-99</td> <td>\$50.63</td> </tr> <tr> <td>100 +</td> <td>\$47.10</td> </tr> </tbody> </table>	PRICE		1-24	\$58.87	25-49	\$54.75	50-99	\$50.63	100 +	\$47.10	 <table border="1"> <thead> <tr> <th colspan="2">PRICE</th> </tr> </thead> <tbody> <tr> <td>1-24</td> <td>\$47.12</td> </tr> <tr> <td>25-49</td> <td>\$43.82</td> </tr> <tr> <td>50-99</td> <td>\$40.52</td> </tr> <tr> <td>100 +</td> <td>\$37.70</td> </tr> </tbody> </table>	PRICE		1-24	\$47.12	25-49	\$43.82	50-99	\$40.52	100 +	\$37.70	 <table border="1"> <thead> <tr> <th colspan="2">PRICE</th> </tr> </thead> <tbody> <tr> <td>1-24</td> <td>\$183.26</td> </tr> <tr> <td>25-49</td> <td>\$170.43</td> </tr> <tr> <td>50-99</td> <td>\$157.60</td> </tr> <tr> <td>100 +</td> <td>\$146.61</td> </tr> </tbody> </table>	PRICE		1-24	\$183.26	25-49	\$170.43	50-99	\$157.60	100 +	\$146.61	 <table border="1"> <thead> <tr> <th colspan="2">PRICE</th> </tr> </thead> <tbody> <tr> <td>1-24</td> <td>\$162.08</td> </tr> <tr> <td>25-49</td> <td>\$150.73</td> </tr> <tr> <td>50-99</td> <td>\$139.39</td> </tr> <tr> <td>100 +</td> <td>\$129.66</td> </tr> </tbody> </table>	PRICE		1-24	\$162.08	25-49	\$150.73	50-99	\$139.39	100 +	\$129.66
	PRICE																																											
1-24	\$58.87																																											
25-49	\$54.75																																											
50-99	\$50.63																																											
100 +	\$47.10																																											
PRICE																																												
1-24	\$47.12																																											
25-49	\$43.82																																											
50-99	\$40.52																																											
100 +	\$37.70																																											
PRICE																																												
1-24	\$183.26																																											
25-49	\$170.43																																											
50-99	\$157.60																																											
100 +	\$146.61																																											
PRICE																																												
1-24	\$162.08																																											
25-49	\$150.73																																											
50-99	\$139.39																																											
100 +	\$129.66																																											
	<b>Model No: PE9253</b> SMA Female To HN Male	<b>Model No: PE9255</b> SMA Female To HN Female	<b>PRECISION</b> <b>Model No: PE9215</b> SMA Male To 7mm Max VSWR 1.15:1 @ 18 GHz	<b>PRECISION</b> <b>Model No: PE9214</b> SMA Female To 7mm Max VSWR 1.15:1 @ 18 GHz																																								
4	 <table border="1"> <thead> <tr> <th colspan="2">PRICE</th> </tr> </thead> <tbody> <tr> <td>1-24</td> <td>\$405.17</td> </tr> <tr> <td>25-49</td> <td>\$376.81</td> </tr> <tr> <td>50-99</td> <td>\$348.45</td> </tr> <tr> <td>100 +</td> <td>\$324.14</td> </tr> </tbody> </table>	PRICE		1-24	\$405.17	25-49	\$376.81	50-99	\$348.45	100 +	\$324.14	 <table border="1"> <thead> <tr> <th colspan="2">PRICE</th> </tr> </thead> <tbody> <tr> <td>1-24</td> <td>\$44.28</td> </tr> <tr> <td>25-49</td> <td>\$41.18</td> </tr> <tr> <td>50-99</td> <td>\$38.08</td> </tr> <tr> <td>100 +</td> <td>\$35.42</td> </tr> </tbody> </table>	PRICE		1-24	\$44.28	25-49	\$41.18	50-99	\$38.08	100 +	\$35.42	 <table border="1"> <thead> <tr> <th colspan="2">PRICE</th> </tr> </thead> <tbody> <tr> <td>1-24</td> <td>\$92.56</td> </tr> <tr> <td>25-49</td> <td>\$86.08</td> </tr> <tr> <td>50-99</td> <td>\$79.60</td> </tr> <tr> <td>100 +</td> <td>\$74.05</td> </tr> </tbody> </table>	PRICE		1-24	\$92.56	25-49	\$86.08	50-99	\$79.60	100 +	\$74.05	 <table border="1"> <thead> <tr> <th colspan="2">PRICE</th> </tr> </thead> <tbody> <tr> <td>1-24</td> <td>\$105.89</td> </tr> <tr> <td>25-49</td> <td>\$98.48</td> </tr> <tr> <td>50-99</td> <td>\$91.07</td> </tr> <tr> <td>100 +</td> <td>\$84.71</td> </tr> </tbody> </table>	PRICE		1-24	\$105.89	25-49	\$98.48	50-99	\$91.07	100 +	\$84.71
	PRICE																																											
1-24	\$405.17																																											
25-49	\$376.81																																											
50-99	\$348.45																																											
100 +	\$324.14																																											
PRICE																																												
1-24	\$44.28																																											
25-49	\$41.18																																											
50-99	\$38.08																																											
100 +	\$35.42																																											
PRICE																																												
1-24	\$92.56																																											
25-49	\$86.08																																											
50-99	\$79.60																																											
100 +	\$74.05																																											
PRICE																																												
1-24	\$105.89																																											
25-49	\$98.48																																											
50-99	\$91.07																																											
100 +	\$84.71																																											
	<b>PRECISION</b> <b>Model No: PE9327</b> SMA Female To 7mm Panel Mount Max VSWR 1.15:1 @ 18 GHz Mounting Hole A05	<b>Model No: PE9786</b> SMA Female To QMA Male	<b>PRECISION</b> <b>Model No: PE9511</b> SMA Male To SMP Male Max VSWR 1.20:1 @ 18 GHz	<b>PRECISION</b> <b>Model No: PE9513</b> SMA Male To SMP Female Max VSWR 1.20:1 @ 18 GHz																																								
5	 <table border="1"> <thead> <tr> <th colspan="2">PRICE</th> </tr> </thead> <tbody> <tr> <td>1-24</td> <td>\$106.04</td> </tr> <tr> <td>25-49</td> <td>\$98.62</td> </tr> <tr> <td>50-99</td> <td>\$91.19</td> </tr> <tr> <td>100 +</td> <td>\$84.83</td> </tr> </tbody> </table>	PRICE		1-24	\$106.04	25-49	\$98.62	50-99	\$91.19	100 +	\$84.83	 <table border="1"> <thead> <tr> <th colspan="2">PRICE</th> </tr> </thead> <tbody> <tr> <td>1-24</td> <td>\$294.31</td> </tr> <tr> <td>25-49</td> <td>\$273.71</td> </tr> <tr> <td>50-99</td> <td>\$253.11</td> </tr> <tr> <td>100 +</td> <td>\$235.45</td> </tr> </tbody> </table>	PRICE		1-24	\$294.31	25-49	\$273.71	50-99	\$253.11	100 +	\$235.45	 <table border="1"> <thead> <tr> <th colspan="2">PRICE</th> </tr> </thead> <tbody> <tr> <td>1-24</td> <td>\$158.94</td> </tr> <tr> <td>25-49</td> <td>\$147.81</td> </tr> <tr> <td>50-99</td> <td>\$136.69</td> </tr> <tr> <td>100 +</td> <td>\$127.15</td> </tr> </tbody> </table>	PRICE		1-24	\$158.94	25-49	\$147.81	50-99	\$136.69	100 +	\$127.15	 <table border="1"> <thead> <tr> <th colspan="2">PRICE</th> </tr> </thead> <tbody> <tr> <td>1-24</td> <td>\$17.12</td> </tr> <tr> <td>25-49</td> <td>\$15.92</td> </tr> <tr> <td>50-99</td> <td>\$14.72</td> </tr> <tr> <td>100 +</td> <td>\$13.70</td> </tr> </tbody> </table>	PRICE		1-24	\$17.12	25-49	\$15.92	50-99	\$14.72	100 +	\$13.70
	PRICE																																											
1-24	\$106.04																																											
25-49	\$98.62																																											
50-99	\$91.19																																											
100 +	\$84.83																																											
PRICE																																												
1-24	\$294.31																																											
25-49	\$273.71																																											
50-99	\$253.11																																											
100 +	\$235.45																																											
PRICE																																												
1-24	\$158.94																																											
25-49	\$147.81																																											
50-99	\$136.69																																											
100 +	\$127.15																																											
PRICE																																												
1-24	\$17.12																																											
25-49	\$15.92																																											
50-99	\$14.72																																											
100 +	\$13.70																																											
	<b>PRECISION</b> <b>Model No: PE9512</b> SMA Female To SMP Male Max VSWR 1.20:1 @ 18 GHz	<b>PRECISION</b> <b>Model No: PE9778</b> SMA Female To SMP Male Max VSWR 1.45:1 @ 26.5 GHz	<b>PRECISION</b> <b>Model No: PE9779</b> SMA Female To SMP Female Max VSWR 1.30:1 @ 18 GHz	<b>NEW</b> <b>Model No: PE91007</b> SMA Male To UMCX Jack																																								
6	 <table border="1"> <thead> <tr> <th colspan="2">PRICE</th> </tr> </thead> <tbody> <tr> <td>1-24</td> <td>\$17.12</td> </tr> <tr> <td>25-49</td> <td>\$15.92</td> </tr> <tr> <td>50-99</td> <td>\$14.72</td> </tr> <tr> <td>100 +</td> <td>\$13.70</td> </tr> </tbody> </table>	PRICE		1-24	\$17.12	25-49	\$15.92	50-99	\$14.72	100 +	\$13.70	 <table border="1"> <thead> <tr> <th colspan="2">PRICE</th> </tr> </thead> <tbody> <tr> <td>1-24</td> <td>\$17.12</td> </tr> <tr> <td>25-49</td> <td>\$15.92</td> </tr> <tr> <td>50-99</td> <td>\$14.72</td> </tr> <tr> <td>100 +</td> <td>\$13.70</td> </tr> </tbody> </table>	PRICE		1-24	\$17.12	25-49	\$15.92	50-99	\$14.72	100 +	\$13.70	 <table border="1"> <thead> <tr> <th colspan="2">PRICE</th> </tr> </thead> <tbody> <tr> <td>1-24</td> <td>\$77.47</td> </tr> <tr> <td>25-49</td> <td>\$72.05</td> </tr> <tr> <td>50-99</td> <td>\$66.62</td> </tr> <tr> <td>100 +</td> <td>\$61.98</td> </tr> </tbody> </table>	PRICE		1-24	\$77.47	25-49	\$72.05	50-99	\$66.62	100 +	\$61.98	 <table border="1"> <thead> <tr> <th colspan="2">PRICE</th> </tr> </thead> <tbody> <tr> <td>1-24</td> <td>\$61.66</td> </tr> <tr> <td>25-49</td> <td>\$57.34</td> </tr> <tr> <td>50-99</td> <td>\$53.03</td> </tr> <tr> <td>100 +</td> <td>\$49.33</td> </tr> </tbody> </table>	PRICE		1-24	\$61.66	25-49	\$57.34	50-99	\$53.03	100 +	\$49.33
	PRICE																																											
1-24	\$17.12																																											
25-49	\$15.92																																											
50-99	\$14.72																																											
100 +	\$13.70																																											
PRICE																																												
1-24	\$17.12																																											
25-49	\$15.92																																											
50-99	\$14.72																																											
100 +	\$13.70																																											
PRICE																																												
1-24	\$77.47																																											
25-49	\$72.05																																											
50-99	\$66.62																																											
100 +	\$61.98																																											
PRICE																																												
1-24	\$61.66																																											
25-49	\$57.34																																											
50-99	\$53.03																																											
100 +	\$49.33																																											
	<b>NEW</b> <b>Model No: PE91005</b> SMA Female To UMCX Plug	<b>NEW</b> <b>Model No: PE91006</b> SMA Female To UMCX Jack	<b>Model No: PE9476</b> SMA Male To MMCX Plug	<b>Model No: PE9478</b> SMA Male To MMCX Jack																																								











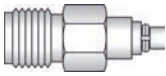
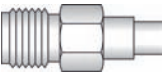
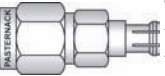

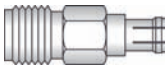





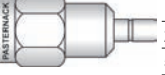

Adapters

See Our Website For Real-Time Stock Availability!

# ADAPTERS

See Adapter Locator on Pages 140-145 or the Adapter Matrix on Pages 138-139

See Page 246 for Mounting Holes

	A	B	C	D																																								
1	 <table border="1"> <thead> <tr> <th colspan="2">PRICE</th> </tr> </thead> <tbody> <tr> <td>1-24</td> <td>\$64.46</td> </tr> <tr> <td>25-49</td> <td>\$59.95</td> </tr> <tr> <td>50-99</td> <td>\$55.44</td> </tr> <tr> <td>100 +</td> <td>\$51.57</td> </tr> </tbody> </table> <p><b>Model No: PE9475</b> SMA Female To MMCX Plug</p>	PRICE		1-24	\$64.46	25-49	\$59.95	50-99	\$55.44	100 +	\$51.57	 <table border="1"> <thead> <tr> <th colspan="2">PRICE</th> </tr> </thead> <tbody> <tr> <td>1-24</td> <td>\$62.72</td> </tr> <tr> <td>25-49</td> <td>\$58.33</td> </tr> <tr> <td>50-99</td> <td>\$53.94</td> </tr> <tr> <td>100 +</td> <td>\$50.18</td> </tr> </tbody> </table> <p><b>Model No: PE9477</b> SMA Female To MMCX Jack</p>	PRICE		1-24	\$62.72	25-49	\$58.33	50-99	\$53.94	100 +	\$50.18	 <table border="1"> <thead> <tr> <th colspan="2">PRICE</th> </tr> </thead> <tbody> <tr> <td>1-24</td> <td>\$58.87</td> </tr> <tr> <td>25-49</td> <td>\$54.75</td> </tr> <tr> <td>50-99</td> <td>\$50.63</td> </tr> <tr> <td>100 +</td> <td>\$47.10</td> </tr> </tbody> </table> <p><b>Model No: PE9473</b> SMA Male To MCX Plug</p>	PRICE		1-24	\$58.87	25-49	\$54.75	50-99	\$50.63	100 +	\$47.10	 <table border="1"> <thead> <tr> <th colspan="2">PRICE</th> </tr> </thead> <tbody> <tr> <td>1-24</td> <td>\$71.84</td> </tr> <tr> <td>25-49</td> <td>\$66.81</td> </tr> <tr> <td>50-99</td> <td>\$61.78</td> </tr> <tr> <td>100 +</td> <td>\$57.47</td> </tr> </tbody> </table> <p><b>Model No: PE9472</b> SMA Male To MCX Jack</p>	PRICE		1-24	\$71.84	25-49	\$66.81	50-99	\$61.78	100 +	\$57.47
	PRICE																																											
	1-24	\$64.46																																										
	25-49	\$59.95																																										
	50-99	\$55.44																																										
	100 +	\$51.57																																										
PRICE																																												
1-24	\$62.72																																											
25-49	\$58.33																																											
50-99	\$53.94																																											
100 +	\$50.18																																											
PRICE																																												
1-24	\$58.87																																											
25-49	\$54.75																																											
50-99	\$50.63																																											
100 +	\$47.10																																											
PRICE																																												
1-24	\$71.84																																											
25-49	\$66.81																																											
50-99	\$61.78																																											
100 +	\$57.47																																											
2	 <table border="1"> <thead> <tr> <th colspan="2">PRICE</th> </tr> </thead> <tbody> <tr> <td>1-24</td> <td>\$57.10</td> </tr> <tr> <td>25-49</td> <td>\$53.10</td> </tr> <tr> <td>50-99</td> <td>\$49.11</td> </tr> <tr> <td>100 +</td> <td>\$45.68</td> </tr> </tbody> </table> <p><b>Model No: PE9471</b> SMA Female To MCX Plug</p>	PRICE		1-24	\$57.10	25-49	\$53.10	50-99	\$49.11	100 +	\$45.68	 <table border="1"> <thead> <tr> <th colspan="2">PRICE</th> </tr> </thead> <tbody> <tr> <td>1-24</td> <td>\$49.65</td> </tr> <tr> <td>25-49</td> <td>\$46.17</td> </tr> <tr> <td>50-99</td> <td>\$42.70</td> </tr> <tr> <td>100 +</td> <td>\$39.72</td> </tr> </tbody> </table> <p><b>Model No: PE9470</b> SMA Female To MCX Jack</p>	PRICE		1-24	\$49.65	25-49	\$46.17	50-99	\$42.70	100 +	\$39.72	 <table border="1"> <thead> <tr> <th colspan="2">PRICE</th> </tr> </thead> <tbody> <tr> <td>1-24</td> <td>\$65.16</td> </tr> <tr> <td>25-49</td> <td>\$60.60</td> </tr> <tr> <td>50-99</td> <td>\$56.04</td> </tr> <tr> <td>100 +</td> <td>\$52.13</td> </tr> </tbody> </table> <p><b>Model No: PE9581</b> SMA Male To Reverse Polarity MCX Plug</p>	PRICE		1-24	\$65.16	25-49	\$60.60	50-99	\$56.04	100 +	\$52.13	 <table border="1"> <thead> <tr> <th colspan="2">PRICE</th> </tr> </thead> <tbody> <tr> <td>1-24</td> <td>\$74.02</td> </tr> <tr> <td>25-49</td> <td>\$68.84</td> </tr> <tr> <td>50-99</td> <td>\$63.66</td> </tr> <tr> <td>100 +</td> <td>\$59.22</td> </tr> </tbody> </table> <p><b>Model No: PE9144</b> SMA Male To SMB Plug</p>	PRICE		1-24	\$74.02	25-49	\$68.84	50-99	\$63.66	100 +	\$59.22
	PRICE																																											
	1-24	\$57.10																																										
	25-49	\$53.10																																										
	50-99	\$49.11																																										
	100 +	\$45.68																																										
PRICE																																												
1-24	\$49.65																																											
25-49	\$46.17																																											
50-99	\$42.70																																											
100 +	\$39.72																																											
PRICE																																												
1-24	\$65.16																																											
25-49	\$60.60																																											
50-99	\$56.04																																											
100 +	\$52.13																																											
PRICE																																												
1-24	\$74.02																																											
25-49	\$68.84																																											
50-99	\$63.66																																											
100 +	\$59.22																																											
3	 <table border="1"> <thead> <tr> <th colspan="2">PRICE</th> </tr> </thead> <tbody> <tr> <td>1-24</td> <td>\$39.06</td> </tr> <tr> <td>25-49</td> <td>\$36.33</td> </tr> <tr> <td>50-99</td> <td>\$33.59</td> </tr> <tr> <td>100 +</td> <td>\$31.25</td> </tr> </tbody> </table> <p><b>Model No: PE9145</b> SMA Male To SMB Jack</p>	PRICE		1-24	\$39.06	25-49	\$36.33	50-99	\$33.59	100 +	\$31.25	 <table border="1"> <thead> <tr> <th colspan="2">PRICE</th> </tr> </thead> <tbody> <tr> <td>1-24</td> <td>\$41.54</td> </tr> <tr> <td>25-49</td> <td>\$38.63</td> </tr> <tr> <td>50-99</td> <td>\$35.72</td> </tr> <tr> <td>100 +</td> <td>\$33.23</td> </tr> </tbody> </table> <p><b>Model No: PE9142</b> SMA Female To SMB Plug</p>	PRICE		1-24	\$41.54	25-49	\$38.63	50-99	\$35.72	100 +	\$33.23	 <table border="1"> <thead> <tr> <th colspan="2">PRICE</th> </tr> </thead> <tbody> <tr> <td>1-24</td> <td>\$39.06</td> </tr> <tr> <td>25-49</td> <td>\$36.33</td> </tr> <tr> <td>50-99</td> <td>\$33.59</td> </tr> <tr> <td>100 +</td> <td>\$31.25</td> </tr> </tbody> </table> <p><b>Model No: PE9143</b> SMA Female To SMB Jack</p>	PRICE		1-24	\$39.06	25-49	\$36.33	50-99	\$33.59	100 +	\$31.25	 <table border="1"> <thead> <tr> <th colspan="2">PRICE</th> </tr> </thead> <tbody> <tr> <td>1-24</td> <td>\$63.69</td> </tr> <tr> <td>25-49</td> <td>\$59.23</td> </tr> <tr> <td>50-99</td> <td>\$54.77</td> </tr> <tr> <td>100 +</td> <td>\$50.95</td> </tr> </tbody> </table> <p><b>Model No: PE9401</b> SMA Male To SSMB Jack</p>	PRICE		1-24	\$63.69	25-49	\$59.23	50-99	\$54.77	100 +	\$50.95
	PRICE																																											
	1-24	\$39.06																																										
	25-49	\$36.33																																										
	50-99	\$33.59																																										
	100 +	\$31.25																																										
PRICE																																												
1-24	\$41.54																																											
25-49	\$38.63																																											
50-99	\$35.72																																											
100 +	\$33.23																																											
PRICE																																												
1-24	\$39.06																																											
25-49	\$36.33																																											
50-99	\$33.59																																											
100 +	\$31.25																																											
PRICE																																												
1-24	\$63.69																																											
25-49	\$59.23																																											
50-99	\$54.77																																											
100 +	\$50.95																																											
4	 <table border="1"> <thead> <tr> <th colspan="2">PRICE</th> </tr> </thead> <tbody> <tr> <td>1-24</td> <td>\$46.21</td> </tr> <tr> <td>25-49</td> <td>\$42.98</td> </tr> <tr> <td>50-99</td> <td>\$39.74</td> </tr> <tr> <td>100 +</td> <td>\$36.97</td> </tr> </tbody> </table> <p><b>Model No: PE9402</b> SMA Female To SSMB Plug</p>	PRICE		1-24	\$46.21	25-49	\$42.98	50-99	\$39.74	100 +	\$36.97	 <table border="1"> <thead> <tr> <th colspan="2">PRICE</th> </tr> </thead> <tbody> <tr> <td>1-24</td> <td>\$64.70</td> </tr> <tr> <td>25-49</td> <td>\$60.17</td> </tr> <tr> <td>50-99</td> <td>\$55.64</td> </tr> <tr> <td>100 +</td> <td>\$51.76</td> </tr> </tbody> </table> <p><b>Model No: PE9692</b> SMA Male To 1.0/2.3 Slide On Plug</p>	PRICE		1-24	\$64.70	25-49	\$60.17	50-99	\$55.64	100 +	\$51.76	 <table border="1"> <thead> <tr> <th colspan="2">PRICE</th> </tr> </thead> <tbody> <tr> <td>1-24</td> <td>\$66.02</td> </tr> <tr> <td>25-49</td> <td>\$61.40</td> </tr> <tr> <td>50-99</td> <td>\$56.78</td> </tr> <tr> <td>100 +</td> <td>\$52.82</td> </tr> </tbody> </table> <p><b>Model No: PE9690</b> SMA Male To 1.0/2.3 Slide On Jack</p>	PRICE		1-24	\$66.02	25-49	\$61.40	50-99	\$56.78	100 +	\$52.82	 <table border="1"> <thead> <tr> <th colspan="2">PRICE</th> </tr> </thead> <tbody> <tr> <td>1-24</td> <td>\$63.58</td> </tr> <tr> <td>25-49</td> <td>\$59.13</td> </tr> <tr> <td>50-99</td> <td>\$54.68</td> </tr> <tr> <td>100 +</td> <td>\$50.86</td> </tr> </tbody> </table> <p><b>Model No: PE9691</b> SMA Female To 1.0/2.3 Slide On Plug</p>	PRICE		1-24	\$63.58	25-49	\$59.13	50-99	\$54.68	100 +	\$50.86
	PRICE																																											
	1-24	\$46.21																																										
	25-49	\$42.98																																										
	50-99	\$39.74																																										
	100 +	\$36.97																																										
PRICE																																												
1-24	\$64.70																																											
25-49	\$60.17																																											
50-99	\$55.64																																											
100 +	\$51.76																																											
PRICE																																												
1-24	\$66.02																																											
25-49	\$61.40																																											
50-99	\$56.78																																											
100 +	\$52.82																																											
PRICE																																												
1-24	\$63.58																																											
25-49	\$59.13																																											
50-99	\$54.68																																											
100 +	\$50.86																																											
5	 <table border="1"> <thead> <tr> <th colspan="2">PRICE</th> </tr> </thead> <tbody> <tr> <td>1-24</td> <td>\$64.70</td> </tr> <tr> <td>25-49</td> <td>\$60.17</td> </tr> <tr> <td>50-99</td> <td>\$55.64</td> </tr> <tr> <td>100 +</td> <td>\$51.76</td> </tr> </tbody> </table> <p><b>Model No: PE9693</b> SMA Female To 1.0/2.3 Slide On Jack</p>	PRICE		1-24	\$64.70	25-49	\$60.17	50-99	\$55.64	100 +	\$51.76	 <table border="1"> <thead> <tr> <th colspan="2">PRICE</th> </tr> </thead> <tbody> <tr> <td>1-24</td> <td>\$57.81</td> </tr> <tr> <td>25-49</td> <td>\$53.76</td> </tr> <tr> <td>50-99</td> <td>\$49.72</td> </tr> <tr> <td>100 +</td> <td>\$46.25</td> </tr> </tbody> </table> <p><b>PRECISION</b> <b>Model No: PE9493</b> SMA Male To BNC Male Max VSWR 1.25:1 @ 8 GHz</p>	PRICE		1-24	\$57.81	25-49	\$53.76	50-99	\$49.72	100 +	\$46.25	 <table border="1"> <thead> <tr> <th colspan="2">PRICE</th> </tr> </thead> <tbody> <tr> <td>1-24</td> <td>\$30.89</td> </tr> <tr> <td>25-49</td> <td>\$28.73</td> </tr> <tr> <td>50-99</td> <td>\$26.57</td> </tr> <tr> <td>100 +</td> <td>\$24.71</td> </tr> </tbody> </table> <p><b>Model No: PE9072</b> SMA Male To BNC Male</p>	PRICE		1-24	\$30.89	25-49	\$28.73	50-99	\$26.57	100 +	\$24.71	 <table border="1"> <thead> <tr> <th colspan="2">PRICE</th> </tr> </thead> <tbody> <tr> <td>1-24</td> <td>\$104.12</td> </tr> <tr> <td>25-49</td> <td>\$96.83</td> </tr> <tr> <td>50-99</td> <td>\$89.54</td> </tr> <tr> <td>100 +</td> <td>\$83.30</td> </tr> </tbody> </table> <p><b>PRECISION</b> <b>Model No: PE9495</b> SMA Male To BNC Female Max VSWR 1.25:1 @ 8 GHz</p>	PRICE		1-24	\$104.12	25-49	\$96.83	50-99	\$89.54	100 +	\$83.30
	PRICE																																											
	1-24	\$64.70																																										
	25-49	\$60.17																																										
	50-99	\$55.64																																										
	100 +	\$51.76																																										
PRICE																																												
1-24	\$57.81																																											
25-49	\$53.76																																											
50-99	\$49.72																																											
100 +	\$46.25																																											
PRICE																																												
1-24	\$30.89																																											
25-49	\$28.73																																											
50-99	\$26.57																																											
100 +	\$24.71																																											
PRICE																																												
1-24	\$104.12																																											
25-49	\$96.83																																											
50-99	\$89.54																																											
100 +	\$83.30																																											
6	 <table border="1"> <thead> <tr> <th colspan="2">PRICE</th> </tr> </thead> <tbody> <tr> <td>1-24</td> <td>\$28.88</td> </tr> <tr> <td>25-49</td> <td>\$26.86</td> </tr> <tr> <td>50-99</td> <td>\$24.84</td> </tr> <tr> <td>100 +</td> <td>\$23.10</td> </tr> </tbody> </table> <p><b>Model No: PE9074</b> SMA Male To BNC Female</p>	PRICE		1-24	\$28.88	25-49	\$26.86	50-99	\$24.84	100 +	\$23.10	 <table border="1"> <thead> <tr> <th colspan="2">PRICE</th> </tr> </thead> <tbody> <tr> <td>1-24</td> <td>\$52.69</td> </tr> <tr> <td>25-49</td> <td>\$49.00</td> </tr> <tr> <td>50-99</td> <td>\$45.31</td> </tr> <tr> <td>100 +</td> <td>\$42.15</td> </tr> </tbody> </table> <p><b>PRECISION</b> <b>Model No: PE9494</b> SMA Female To BNC Male Max VSWR 1.25:1 @ 8 GHz</p>	PRICE		1-24	\$52.69	25-49	\$49.00	50-99	\$45.31	100 +	\$42.15	 <table border="1"> <thead> <tr> <th colspan="2">PRICE</th> </tr> </thead> <tbody> <tr> <td>1-24</td> <td>\$28.88</td> </tr> <tr> <td>25-49</td> <td>\$26.86</td> </tr> <tr> <td>50-99</td> <td>\$24.84</td> </tr> <tr> <td>100 +</td> <td>\$23.10</td> </tr> </tbody> </table> <p><b>Model No: PE9073</b> SMA Female To BNC Male</p>	PRICE		1-24	\$28.88	25-49	\$26.86	50-99	\$24.84	100 +	\$23.10	 <table border="1"> <thead> <tr> <th colspan="2">PRICE</th> </tr> </thead> <tbody> <tr> <td>1-24</td> <td>\$57.81</td> </tr> <tr> <td>25-49</td> <td>\$53.76</td> </tr> <tr> <td>50-99</td> <td>\$49.72</td> </tr> <tr> <td>100 +</td> <td>\$46.25</td> </tr> </tbody> </table> <p><b>PRECISION</b> <b>Model No: PE9496</b> SMA Female To BNC Female Max VSWR 1.25:1 @ 8 GHz</p>	PRICE		1-24	\$57.81	25-49	\$53.76	50-99	\$49.72	100 +	\$46.25
	PRICE																																											
	1-24	\$28.88																																										
	25-49	\$26.86																																										
	50-99	\$24.84																																										
	100 +	\$23.10																																										
PRICE																																												
1-24	\$52.69																																											
25-49	\$49.00																																											
50-99	\$45.31																																											
100 +	\$42.15																																											
PRICE																																												
1-24	\$28.88																																											
25-49	\$26.86																																											
50-99	\$24.84																																											
100 +	\$23.10																																											
PRICE																																												
1-24	\$57.81																																											
25-49	\$53.76																																											
50-99	\$49.72																																											
100 +	\$46.25																																											













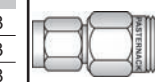
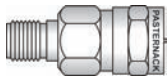



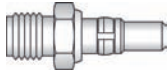

Adapters

See Our Website For Real-Time Stock Availability!

# ADAPTERS

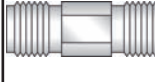
See Adapter Locator on Pages 140-145 or the Adapter Matrix on Pages 138-139

See Page 246 for Mounting Holes

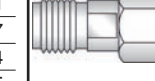
	A	B	C	D																																								
1	 <table border="1"> <thead> <tr> <th colspan="2">PRICE</th> </tr> </thead> <tbody> <tr> <td>1-24</td> <td>\$32.83</td> </tr> <tr> <td>25-49</td> <td>\$30.53</td> </tr> <tr> <td>50-99</td> <td>\$28.23</td> </tr> <tr> <td>100 +</td> <td>\$26.26</td> </tr> </tbody> </table> <p><b>Model No: PE9075</b> SMA Female To BNC Female</p>	PRICE		1-24	\$32.83	25-49	\$30.53	50-99	\$28.23	100 +	\$26.26	 <table border="1"> <thead> <tr> <th colspan="2">PRICE</th> </tr> </thead> <tbody> <tr> <td>1-24</td> <td>\$40.13</td> </tr> <tr> <td>25-49</td> <td>\$37.32</td> </tr> <tr> <td>50-99</td> <td>\$34.51</td> </tr> <tr> <td>100 +</td> <td>\$32.10</td> </tr> </tbody> </table> <p><b>Model No: PE9185</b> SMA Female To BNC Female Bulkhead Mounting Hole B06</p>	PRICE		1-24	\$40.13	25-49	\$37.32	50-99	\$34.51	100 +	\$32.10	 <table border="1"> <thead> <tr> <th colspan="2">PRICE</th> </tr> </thead> <tbody> <tr> <td>1-24</td> <td>\$47.88</td> </tr> <tr> <td>25-49</td> <td>\$44.53</td> </tr> <tr> <td>50-99</td> <td>\$41.18</td> </tr> <tr> <td>100 +</td> <td>\$38.30</td> </tr> </tbody> </table> <p><b>Model No: PE9407</b> SMA Female Bulkhead To BNC Female, Nut On SMA Mounting Hole B04</p>	PRICE		1-24	\$47.88	25-49	\$44.53	50-99	\$41.18	100 +	\$38.30	 <table border="1"> <thead> <tr> <th colspan="2">PRICE</th> </tr> </thead> <tbody> <tr> <td>1-24</td> <td>\$53.70</td> </tr> <tr> <td>25-49</td> <td>\$49.94</td> </tr> <tr> <td>50-99</td> <td>\$46.18</td> </tr> <tr> <td>100 +</td> <td>\$42.96</td> </tr> </tbody> </table> <p><b>NEW</b> <b>Model No: PE91003</b> 50 Ohm SMA Male To F Female</p>	PRICE		1-24	\$53.70	25-49	\$49.94	50-99	\$46.18	100 +	\$42.96
PRICE																																												
1-24	\$32.83																																											
25-49	\$30.53																																											
50-99	\$28.23																																											
100 +	\$26.26																																											
PRICE																																												
1-24	\$40.13																																											
25-49	\$37.32																																											
50-99	\$34.51																																											
100 +	\$32.10																																											
PRICE																																												
1-24	\$47.88																																											
25-49	\$44.53																																											
50-99	\$41.18																																											
100 +	\$38.30																																											
PRICE																																												
1-24	\$53.70																																											
25-49	\$49.94																																											
50-99	\$46.18																																											
100 +	\$42.96																																											
2	 <table border="1"> <thead> <tr> <th colspan="2">PRICE</th> </tr> </thead> <tbody> <tr> <td>1-24</td> <td>\$53.70</td> </tr> <tr> <td>25-49</td> <td>\$49.94</td> </tr> <tr> <td>50-99</td> <td>\$46.18</td> </tr> <tr> <td>100 +</td> <td>\$42.96</td> </tr> </tbody> </table> <p><b>NEW</b> <b>Model No: PE91001</b> 50 Ohm SMA Female To F Male</p>	PRICE		1-24	\$53.70	25-49	\$49.94	50-99	\$46.18	100 +	\$42.96	 <table border="1"> <thead> <tr> <th colspan="2">PRICE</th> </tr> </thead> <tbody> <tr> <td>1-24</td> <td>\$51.53</td> </tr> <tr> <td>25-49</td> <td>\$47.92</td> </tr> <tr> <td>50-99</td> <td>\$44.32</td> </tr> <tr> <td>100 +</td> <td>\$41.22</td> </tr> </tbody> </table> <p><b>NEW</b> <b>Model No: PE91002</b> 50 Ohm SMA Female To F Female</p>	PRICE		1-24	\$51.53	25-49	\$47.92	50-99	\$44.32	100 +	\$41.22	 <table border="1"> <thead> <tr> <th colspan="2">PRICE</th> </tr> </thead> <tbody> <tr> <td>1-24</td> <td>\$23.51</td> </tr> <tr> <td>25-49</td> <td>\$21.86</td> </tr> <tr> <td>50-99</td> <td>\$20.22</td> </tr> <tr> <td>100 +</td> <td>\$18.81</td> </tr> </tbody> </table> <p><b>Model No: PE9425</b> SMA Male To D Subminiature Plug</p>	PRICE		1-24	\$23.51	25-49	\$21.86	50-99	\$20.22	100 +	\$18.81	 <table border="1"> <thead> <tr> <th colspan="2">PRICE</th> </tr> </thead> <tbody> <tr> <td>1-24</td> <td>\$23.51</td> </tr> <tr> <td>25-49</td> <td>\$21.86</td> </tr> <tr> <td>50-99</td> <td>\$20.22</td> </tr> <tr> <td>100 +</td> <td>\$18.81</td> </tr> </tbody> </table> <p><b>Model No: PE9424</b> SMA Male To D Subminiature Receptacle</p>	PRICE		1-24	\$23.51	25-49	\$21.86	50-99	\$20.22	100 +	\$18.81
PRICE																																												
1-24	\$53.70																																											
25-49	\$49.94																																											
50-99	\$46.18																																											
100 +	\$42.96																																											
PRICE																																												
1-24	\$51.53																																											
25-49	\$47.92																																											
50-99	\$44.32																																											
100 +	\$41.22																																											
PRICE																																												
1-24	\$23.51																																											
25-49	\$21.86																																											
50-99	\$20.22																																											
100 +	\$18.81																																											
PRICE																																												
1-24	\$23.51																																											
25-49	\$21.86																																											
50-99	\$20.22																																											
100 +	\$18.81																																											
3	 <table border="1"> <thead> <tr> <th colspan="2">PRICE</th> </tr> </thead> <tbody> <tr> <td>1-24</td> <td>\$23.51</td> </tr> <tr> <td>25-49</td> <td>\$21.86</td> </tr> <tr> <td>50-99</td> <td>\$20.22</td> </tr> <tr> <td>100 +</td> <td>\$18.81</td> </tr> </tbody> </table> <p><b>Model No: PE9422</b> SMA Female To D Subminiature Plug</p>	PRICE		1-24	\$23.51	25-49	\$21.86	50-99	\$20.22	100 +	\$18.81	 <table border="1"> <thead> <tr> <th colspan="2">PRICE</th> </tr> </thead> <tbody> <tr> <td>1-24</td> <td>\$23.51</td> </tr> <tr> <td>25-49</td> <td>\$21.86</td> </tr> <tr> <td>50-99</td> <td>\$20.22</td> </tr> <tr> <td>100 +</td> <td>\$18.81</td> </tr> </tbody> </table> <p><b>Model No: PE9423</b> SMA Female To D Subminiature Receptacle</p>	PRICE		1-24	\$23.51	25-49	\$21.86	50-99	\$20.22	100 +	\$18.81	 <table border="1"> <thead> <tr> <th colspan="2">PRICE</th> </tr> </thead> <tbody> <tr> <td>1-24</td> <td>\$130.36</td> </tr> <tr> <td>25-49</td> <td>\$121.23</td> </tr> <tr> <td>50-99</td> <td>\$112.11</td> </tr> <tr> <td>100 +</td> <td>\$104.29</td> </tr> </tbody> </table> <p><b>Model No: PE9259</b> SMA Male To GR874</p>	PRICE		1-24	\$130.36	25-49	\$121.23	50-99	\$112.11	100 +	\$104.29	 <table border="1"> <thead> <tr> <th colspan="2">PRICE</th> </tr> </thead> <tbody> <tr> <td>1-24</td> <td>\$130.36</td> </tr> <tr> <td>25-49</td> <td>\$121.23</td> </tr> <tr> <td>50-99</td> <td>\$112.11</td> </tr> <tr> <td>100 +</td> <td>\$104.29</td> </tr> </tbody> </table> <p><b>Model No: PE9260</b> SMA Female To GR874</p>	PRICE		1-24	\$130.36	25-49	\$121.23	50-99	\$112.11	100 +	\$104.29
PRICE																																												
1-24	\$23.51																																											
25-49	\$21.86																																											
50-99	\$20.22																																											
100 +	\$18.81																																											
PRICE																																												
1-24	\$23.51																																											
25-49	\$21.86																																											
50-99	\$20.22																																											
100 +	\$18.81																																											
PRICE																																												
1-24	\$130.36																																											
25-49	\$121.23																																											
50-99	\$112.11																																											
100 +	\$104.29																																											
PRICE																																												
1-24	\$130.36																																											
25-49	\$121.23																																											
50-99	\$112.11																																											
100 +	\$104.29																																											
4	<p><b>3.5mm In-Series</b></p> <p>→</p>	 <table border="1"> <thead> <tr> <th colspan="2">PRICE</th> </tr> </thead> <tbody> <tr> <td>1-24</td> <td>\$150.42</td> </tr> <tr> <td>25-49</td> <td>\$139.89</td> </tr> <tr> <td>50-99</td> <td>\$129.36</td> </tr> <tr> <td>100 +</td> <td>\$120.34</td> </tr> </tbody> </table> <p><b>PRECISION</b> <b>Model No: PE9330</b> 3.5mm Male To 3.5mm Male Bulkhead, Mounting Hole B05 Max VSWR 1.15:1 @ 26.5 GHz</p>	PRICE		1-24	\$150.42	25-49	\$139.89	50-99	\$129.36	100 +	\$120.34	 <table border="1"> <thead> <tr> <th colspan="2">PRICE</th> </tr> </thead> <tbody> <tr> <td>1-24</td> <td>\$223.69</td> </tr> <tr> <td>25-49</td> <td>\$208.03</td> </tr> <tr> <td>50-99</td> <td>\$192.37</td> </tr> <tr> <td>100 +</td> <td>\$178.95</td> </tr> </tbody> </table> <p><b>PRECISION</b> <b>Model No: PE9679</b> 3.5mm Male To 3.5mm Male Bulkhead, Mounting Hole B05 Max VSWR 1.25:1 @ 34 GHz</p>	PRICE		1-24	\$223.69	25-49	\$208.03	50-99	\$192.37	100 +	\$178.95	 <table border="1"> <thead> <tr> <th colspan="2">PRICE</th> </tr> </thead> <tbody> <tr> <td>1-24</td> <td>\$150.42</td> </tr> <tr> <td>25-49</td> <td>\$139.89</td> </tr> <tr> <td>50-99</td> <td>\$129.36</td> </tr> <tr> <td>100 +</td> <td>\$120.34</td> </tr> </tbody> </table> <p><b>PRECISION</b> <b>Model No: PE9332</b> 3.5mm Male To 3.5mm Female Bulkhead, Mounting Hole B05 Max VSWR 1.15:1 @ 26.5 GHz</p>	PRICE		1-24	\$150.42	25-49	\$139.89	50-99	\$129.36	100 +	\$120.34										
PRICE																																												
1-24	\$150.42																																											
25-49	\$139.89																																											
50-99	\$129.36																																											
100 +	\$120.34																																											
PRICE																																												
1-24	\$223.69																																											
25-49	\$208.03																																											
50-99	\$192.37																																											
100 +	\$178.95																																											
PRICE																																												
1-24	\$150.42																																											
25-49	\$139.89																																											
50-99	\$129.36																																											
100 +	\$120.34																																											
5	 <table border="1"> <thead> <tr> <th colspan="2">PRICE</th> </tr> </thead> <tbody> <tr> <td>1-24</td> <td>\$141.25</td> </tr> <tr> <td>25-49</td> <td>\$131.36</td> </tr> <tr> <td>50-99</td> <td>\$121.48</td> </tr> <tr> <td>100 +</td> <td>\$113.00</td> </tr> </tbody> </table> <p><b>PRECISION</b> <b>Model No: PE9677</b> 3.5mm Male To 3.5mm Female Bulkhead, Mounting Hole B09 Max VSWR 1.25:1 @ 34 GHz</p>	PRICE		1-24	\$141.25	25-49	\$131.36	50-99	\$121.48	100 +	\$113.00	 <table border="1"> <thead> <tr> <th colspan="2">PRICE</th> </tr> </thead> <tbody> <tr> <td>1-24</td> <td>\$116.07</td> </tr> <tr> <td>25-49</td> <td>\$107.95</td> </tr> <tr> <td>50-99</td> <td>\$99.82</td> </tr> <tr> <td>100 +</td> <td>\$92.86</td> </tr> </tbody> </table> <p><b>PRECISION</b> <b>Model No: PE9331</b> 3.5mm Female To 3.5mm Female Bulkhead, Mounting Hole B09 Max VSWR 1.15:1 @ 26.5 GHz</p>	PRICE		1-24	\$116.07	25-49	\$107.95	50-99	\$99.82	100 +	\$92.86	 <table border="1"> <thead> <tr> <th colspan="2">PRICE</th> </tr> </thead> <tbody> <tr> <td>1-24</td> <td>\$129.45</td> </tr> <tr> <td>25-49</td> <td>\$120.39</td> </tr> <tr> <td>50-99</td> <td>\$111.33</td> </tr> <tr> <td>100 +</td> <td>\$103.56</td> </tr> </tbody> </table> <p><b>PRECISION</b> <b>Model No: PE9678</b> 3.5mm Female To 3.5mm Female Bulkhead, Mounting Hole B09 Max VSWR 1.25:1 @ 34 GHz</p>	PRICE		1-24	\$129.45	25-49	\$120.39	50-99	\$111.33	100 +	\$103.56	 <table border="1"> <thead> <tr> <th colspan="2">PRICE</th> </tr> </thead> <tbody> <tr> <td>1-24</td> <td>\$176.57</td> </tr> <tr> <td>25-49</td> <td>\$164.21</td> </tr> <tr> <td>50-99</td> <td>\$151.85</td> </tr> <tr> <td>100 +</td> <td>\$141.26</td> </tr> </tbody> </table> <p><b>PRECISION</b> <b>Model No: PE9676</b> 3.5mm Female To 3.5mm Female 4 Hole Panel Mount Mounting Hole A01 Max VSWR 1.25:1 @ 34 GHz</p>	PRICE		1-24	\$176.57	25-49	\$164.21	50-99	\$151.85	100 +	\$141.26
PRICE																																												
1-24	\$141.25																																											
25-49	\$131.36																																											
50-99	\$121.48																																											
100 +	\$113.00																																											
PRICE																																												
1-24	\$116.07																																											
25-49	\$107.95																																											
50-99	\$99.82																																											
100 +	\$92.86																																											
PRICE																																												
1-24	\$129.45																																											
25-49	\$120.39																																											
50-99	\$111.33																																											
100 +	\$103.56																																											
PRICE																																												
1-24	\$176.57																																											
25-49	\$164.21																																											
50-99	\$151.85																																											
100 +	\$141.26																																											
6	<p><b>3.5mm Between-Series</b></p> <p>→</p>	 <table border="1"> <thead> <tr> <th colspan="2">PRICE</th> </tr> </thead> <tbody> <tr> <td>1-24</td> <td>\$153.01</td> </tr> <tr> <td>25-49</td> <td>\$142.30</td> </tr> <tr> <td>50-99</td> <td>\$131.59</td> </tr> <tr> <td>100 +</td> <td>\$122.41</td> </tr> </tbody> </table> <p><b>PRECISION</b> <b>Model No: PE9657</b> 3.5mm Male To 2.92mm Male Max VSWR 1.25:1 @ 34 GHz</p>	PRICE		1-24	\$153.01	25-49	\$142.30	50-99	\$131.59	100 +	\$122.41	 <table border="1"> <thead> <tr> <th colspan="2">PRICE</th> </tr> </thead> <tbody> <tr> <td>1-24</td> <td>\$164.81</td> </tr> <tr> <td>25-49</td> <td>\$153.27</td> </tr> <tr> <td>50-99</td> <td>\$141.74</td> </tr> <tr> <td>100 +</td> <td>\$131.85</td> </tr> </tbody> </table> <p><b>PRECISION</b> <b>Model No: PE9658</b> 3.5mm Male To 2.92mm Female Max VSWR 1.25:1 @ 34 GHz</p>	PRICE		1-24	\$164.81	25-49	\$153.27	50-99	\$141.74	100 +	\$131.85	 <table border="1"> <thead> <tr> <th colspan="2">PRICE</th> </tr> </thead> <tbody> <tr> <td>1-24</td> <td>\$162.08</td> </tr> <tr> <td>25-49</td> <td>\$150.73</td> </tr> <tr> <td>50-99</td> <td>\$139.39</td> </tr> <tr> <td>100 +</td> <td>\$129.66</td> </tr> </tbody> </table> <p><b>PRECISION</b> <b>Model No: PE9659</b> 3.5mm Female To 2.92mm Male Max VSWR 1.25:1 @ 34 GHz</p>	PRICE		1-24	\$162.08	25-49	\$150.73	50-99	\$139.39	100 +	\$129.66										
PRICE																																												
1-24	\$153.01																																											
25-49	\$142.30																																											
50-99	\$131.59																																											
100 +	\$122.41																																											
PRICE																																												
1-24	\$164.81																																											
25-49	\$153.27																																											
50-99	\$141.74																																											
100 +	\$131.85																																											
PRICE																																												
1-24	\$162.08																																											
25-49	\$150.73																																											
50-99	\$139.39																																											
100 +	\$129.66																																											

Adapters

See Our Website For Real-Time Stock Availability!













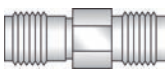

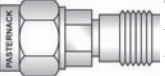
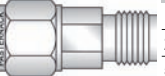
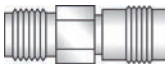

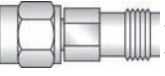
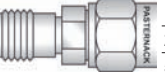
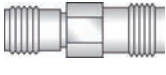
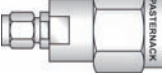

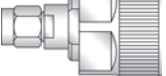
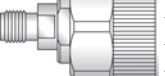

# ADAPTERS

See Adapter Locator on Pages 140-145 or the Adapter Matrix on Pages 138-139

See Page 246 for Mounting Holes

Adapters

See Our Website For Real-Time Stock Availability!

	A	B	C	D																																								
1	 <table border="1"> <thead> <tr> <th colspan="2">PRICE</th> </tr> </thead> <tbody> <tr> <td>1-24</td> <td>\$164.81</td> </tr> <tr> <td>25-49</td> <td>\$153.27</td> </tr> <tr> <td>50-99</td> <td>\$141.74</td> </tr> <tr> <td>100 +</td> <td>\$131.85</td> </tr> </tbody> </table> <p><b>PRECISION</b> Model No: <b>PE9660</b> 3.5mm Female To 2.92mm Female Max VSWR 1.25:1 @ 34 GHz</p>	PRICE		1-24	\$164.81	25-49	\$153.27	50-99	\$141.74	100 +	\$131.85	 <table border="1"> <thead> <tr> <th colspan="2">PRICE</th> </tr> </thead> <tbody> <tr> <td>1-24</td> <td>\$162.08</td> </tr> <tr> <td>25-49</td> <td>\$150.73</td> </tr> <tr> <td>50-99</td> <td>\$139.39</td> </tr> <tr> <td>100 +</td> <td>\$129.66</td> </tr> </tbody> </table> <p><b>PRECISION</b> Model No: <b>PE9649</b> 3.5mm Male To 2.4mm Male Max VSWR 1.25:1 @ 34 GHz</p>	PRICE		1-24	\$162.08	25-49	\$150.73	50-99	\$139.39	100 +	\$129.66	 <table border="1"> <thead> <tr> <th colspan="2">PRICE</th> </tr> </thead> <tbody> <tr> <td>1-24</td> <td>\$162.08</td> </tr> <tr> <td>25-49</td> <td>\$150.73</td> </tr> <tr> <td>50-99</td> <td>\$139.39</td> </tr> <tr> <td>100 +</td> <td>\$129.66</td> </tr> </tbody> </table> <p><b>PRECISION</b> Model No: <b>PE9651</b> 3.5mm Male To 2.4mm Female Max VSWR 1.25:1 @ 34 GHz</p>	PRICE		1-24	\$162.08	25-49	\$150.73	50-99	\$139.39	100 +	\$129.66	 <table border="1"> <thead> <tr> <th colspan="2">PRICE</th> </tr> </thead> <tbody> <tr> <td>1-24</td> <td>\$165.52</td> </tr> <tr> <td>25-49</td> <td>\$153.93</td> </tr> <tr> <td>50-99</td> <td>\$142.35</td> </tr> <tr> <td>100 +</td> <td>\$132.42</td> </tr> </tbody> </table> <p><b>PRECISION</b> Model No: <b>PE9650</b> 3.5mm Female To 2.4mm Male Max VSWR 1.25:1 @ 34 GHz</p>	PRICE		1-24	\$165.52	25-49	\$153.93	50-99	\$142.35	100 +	\$132.42
	PRICE																																											
1-24	\$164.81																																											
25-49	\$153.27																																											
50-99	\$141.74																																											
100 +	\$131.85																																											
PRICE																																												
1-24	\$162.08																																											
25-49	\$150.73																																											
50-99	\$139.39																																											
100 +	\$129.66																																											
PRICE																																												
1-24	\$162.08																																											
25-49	\$150.73																																											
50-99	\$139.39																																											
100 +	\$129.66																																											
PRICE																																												
1-24	\$165.52																																											
25-49	\$153.93																																											
50-99	\$142.35																																											
100 +	\$132.42																																											
2	 <table border="1"> <thead> <tr> <th colspan="2">PRICE</th> </tr> </thead> <tbody> <tr> <td>1-24</td> <td>\$145.56</td> </tr> <tr> <td>25-49</td> <td>\$135.37</td> </tr> <tr> <td>50-99</td> <td>\$125.18</td> </tr> <tr> <td>100 +</td> <td>\$116.45</td> </tr> </tbody> </table> <p><b>PRECISION</b> Model No: <b>PE9652</b> 3.5mm Female To 2.4mm Female Max VSWR 1.25:1 @ 34 GHz</p>	PRICE		1-24	\$145.56	25-49	\$135.37	50-99	\$125.18	100 +	\$116.45	 <table border="1"> <thead> <tr> <th colspan="2">PRICE</th> </tr> </thead> <tbody> <tr> <td>1-24</td> <td>\$141.25</td> </tr> <tr> <td>25-49</td> <td>\$131.36</td> </tr> <tr> <td>50-99</td> <td>\$121.48</td> </tr> <tr> <td>100 +</td> <td>\$113.00</td> </tr> </tbody> </table> <p><b>PRECISION</b> Model No: <b>PE9746</b> 3.5mm Male To 1.85mm Male Max VSWR 1.25:1 @ 34.5 GHz</p>	PRICE		1-24	\$141.25	25-49	\$131.36	50-99	\$121.48	100 +	\$113.00	 <table border="1"> <thead> <tr> <th colspan="2">PRICE</th> </tr> </thead> <tbody> <tr> <td>1-24</td> <td>\$141.25</td> </tr> <tr> <td>25-49</td> <td>\$131.36</td> </tr> <tr> <td>50-99</td> <td>\$121.48</td> </tr> <tr> <td>100 +</td> <td>\$113.00</td> </tr> </tbody> </table> <p><b>PRECISION</b> Model No: <b>PE9745</b> 3.5mm Male To 1.85mm Female Max VSWR 1.25:1 @ 34.5 GHz</p>	PRICE		1-24	\$141.25	25-49	\$131.36	50-99	\$121.48	100 +	\$113.00	 <table border="1"> <thead> <tr> <th colspan="2">PRICE</th> </tr> </thead> <tbody> <tr> <td>1-24</td> <td>\$141.25</td> </tr> <tr> <td>25-49</td> <td>\$131.36</td> </tr> <tr> <td>50-99</td> <td>\$121.48</td> </tr> <tr> <td>100 +</td> <td>\$113.00</td> </tr> </tbody> </table> <p><b>PRECISION</b> Model No: <b>PE9747</b> 3.5mm Female To 1.85mm Male Max VSWR 1.25:1 @ 34.5 GHz</p>	PRICE		1-24	\$141.25	25-49	\$131.36	50-99	\$121.48	100 +	\$113.00
	PRICE																																											
1-24	\$145.56																																											
25-49	\$135.37																																											
50-99	\$125.18																																											
100 +	\$116.45																																											
PRICE																																												
1-24	\$141.25																																											
25-49	\$131.36																																											
50-99	\$121.48																																											
100 +	\$113.00																																											
PRICE																																												
1-24	\$141.25																																											
25-49	\$131.36																																											
50-99	\$121.48																																											
100 +	\$113.00																																											
PRICE																																												
1-24	\$141.25																																											
25-49	\$131.36																																											
50-99	\$121.48																																											
100 +	\$113.00																																											
3	 <table border="1"> <thead> <tr> <th colspan="2">PRICE</th> </tr> </thead> <tbody> <tr> <td>1-24</td> <td>\$141.25</td> </tr> <tr> <td>25-49</td> <td>\$131.36</td> </tr> <tr> <td>50-99</td> <td>\$121.48</td> </tr> <tr> <td>100 +</td> <td>\$113.00</td> </tr> </tbody> </table> <p><b>PRECISION</b> Model No: <b>PE9748</b> 3.5mm Female To 1.85mm Female Max VSWR 1.30:1 @ 34.5 GHz</p>	PRICE		1-24	\$141.25	25-49	\$131.36	50-99	\$121.48	100 +	\$113.00	 <table border="1"> <thead> <tr> <th colspan="2">PRICE</th> </tr> </thead> <tbody> <tr> <td>1-24</td> <td>\$144.60</td> </tr> <tr> <td>25-49</td> <td>\$134.48</td> </tr> <tr> <td>50-99</td> <td>\$124.36</td> </tr> <tr> <td>100 +</td> <td>\$115.68</td> </tr> </tbody> </table> <p><b>PRECISION</b> Model No: <b>PE9322</b> 3.5mm Male To N Male Max VSWR 1.15:1 @ 18 GHz</p>	PRICE		1-24	\$144.60	25-49	\$134.48	50-99	\$124.36	100 +	\$115.68	 <table border="1"> <thead> <tr> <th colspan="2">PRICE</th> </tr> </thead> <tbody> <tr> <td>1-24</td> <td>\$136.69</td> </tr> <tr> <td>25-49</td> <td>\$127.12</td> </tr> <tr> <td>50-99</td> <td>\$117.55</td> </tr> <tr> <td>100 +</td> <td>\$109.35</td> </tr> </tbody> </table> <p><b>PRECISION</b> Model No: <b>PE9324</b> 3.5mm Male To N Female Max VSWR 1.15:1 @ 18 GHz</p>	PRICE		1-24	\$136.69	25-49	\$127.12	50-99	\$117.55	100 +	\$109.35	 <table border="1"> <thead> <tr> <th colspan="2">PRICE</th> </tr> </thead> <tbody> <tr> <td>1-24</td> <td>\$128.18</td> </tr> <tr> <td>25-49</td> <td>\$119.21</td> </tr> <tr> <td>50-99</td> <td>\$110.23</td> </tr> <tr> <td>100 +</td> <td>\$102.54</td> </tr> </tbody> </table> <p><b>PRECISION</b> Model No: <b>PE9321</b> 3.5mm Female To N Male Max VSWR 1.15:1 @ 18 GHz</p>	PRICE		1-24	\$128.18	25-49	\$119.21	50-99	\$110.23	100 +	\$102.54
	PRICE																																											
1-24	\$141.25																																											
25-49	\$131.36																																											
50-99	\$121.48																																											
100 +	\$113.00																																											
PRICE																																												
1-24	\$144.60																																											
25-49	\$134.48																																											
50-99	\$124.36																																											
100 +	\$115.68																																											
PRICE																																												
1-24	\$136.69																																											
25-49	\$127.12																																											
50-99	\$117.55																																											
100 +	\$109.35																																											
PRICE																																												
1-24	\$128.18																																											
25-49	\$119.21																																											
50-99	\$110.23																																											
100 +	\$102.54																																											
4	 <table border="1"> <thead> <tr> <th colspan="2">PRICE</th> </tr> </thead> <tbody> <tr> <td>1-24</td> <td>\$129.80</td> </tr> <tr> <td>25-49</td> <td>\$120.71</td> </tr> <tr> <td>50-99</td> <td>\$111.63</td> </tr> <tr> <td>100 +</td> <td>\$103.84</td> </tr> </tbody> </table> <p><b>PRECISION</b> Model No: <b>PE9323</b> 3.5mm Female To N Female Max VSWR 1.15:1 @ 18 GHz</p>	PRICE		1-24	\$129.80	25-49	\$120.71	50-99	\$111.63	100 +	\$103.84	 <table border="1"> <thead> <tr> <th colspan="2">PRICE</th> </tr> </thead> <tbody> <tr> <td>1-24</td> <td>\$231.49</td> </tr> <tr> <td>25-49</td> <td>\$215.29</td> </tr> <tr> <td>50-99</td> <td>\$199.08</td> </tr> <tr> <td>100 +</td> <td>\$185.19</td> </tr> </tbody> </table> <p><b>PRECISION</b> Model No: <b>PE9326</b> 3.5mm Male To 7mm Max VSWR 1.15:1 @ 18 GHz</p>	PRICE		1-24	\$231.49	25-49	\$215.29	50-99	\$199.08	100 +	\$185.19	 <table border="1"> <thead> <tr> <th colspan="2">PRICE</th> </tr> </thead> <tbody> <tr> <td>1-24</td> <td>\$337.48</td> </tr> <tr> <td>25-49</td> <td>\$313.86</td> </tr> <tr> <td>50-99</td> <td>\$290.23</td> </tr> <tr> <td>100 +</td> <td>\$269.98</td> </tr> </tbody> </table> <p><b>PRECISION</b> Model No: <b>PE9325</b> 3.5mm Female To 7mm Max VSWR 1.15:1 @ 18 GHz</p>	PRICE		1-24	\$337.48	25-49	\$313.86	50-99	\$290.23	100 +	\$269.98	<div style="background-color: black; color: white; padding: 20px; text-align: center;"> <h2>2.92mm In-Series</h2>  </div>										
	PRICE																																											
1-24	\$129.80																																											
25-49	\$120.71																																											
50-99	\$111.63																																											
100 +	\$103.84																																											
PRICE																																												
1-24	\$231.49																																											
25-49	\$215.29																																											
50-99	\$199.08																																											
100 +	\$185.19																																											
PRICE																																												
1-24	\$337.48																																											
25-49	\$313.86																																											
50-99	\$290.23																																											
100 +	\$269.98																																											
5	 <table border="1"> <thead> <tr> <th colspan="2">PRICE</th> </tr> </thead> <tbody> <tr> <td>1-24</td> <td>\$150.42</td> </tr> <tr> <td>25-49</td> <td>\$139.89</td> </tr> <tr> <td>50-99</td> <td>\$129.36</td> </tr> <tr> <td>100 +</td> <td>\$120.34</td> </tr> </tbody> </table> <p><b>PRECISION</b> Model No: <b>PE9436</b> 2.92mm Male To 2.92mm Male Max VSWR 1.10:1 @ 18 GHz 1.15:1 @ 26.5 GHz 1.25:1 @ 40 GHz</p>	PRICE		1-24	\$150.42	25-49	\$139.89	50-99	\$129.36	100 +	\$120.34	 <table border="1"> <thead> <tr> <th colspan="2">PRICE</th> </tr> </thead> <tbody> <tr> <td>1-24</td> <td>\$231.49</td> </tr> <tr> <td>25-49</td> <td>\$215.29</td> </tr> <tr> <td>50-99</td> <td>\$199.08</td> </tr> <tr> <td>100 +</td> <td>\$185.19</td> </tr> </tbody> </table> <p><b>PRECISION</b> Model No: <b>PE9645</b> 2.92mm Male To 2.92mm Male Right Angle Max VSWR 1.40:1 @ 40 GHz</p>	PRICE		1-24	\$231.49	25-49	\$215.29	50-99	\$199.08	100 +	\$185.19	 <table border="1"> <thead> <tr> <th colspan="2">PRICE</th> </tr> </thead> <tbody> <tr> <td>1-24</td> <td>\$150.42</td> </tr> <tr> <td>25-49</td> <td>\$139.89</td> </tr> <tr> <td>50-99</td> <td>\$129.36</td> </tr> <tr> <td>100 +</td> <td>\$120.34</td> </tr> </tbody> </table> <p><b>PRECISION</b> Model No: <b>PE9437</b> 2.92mm Male To 2.92mm Female Max VSWR 1.10:1 @ 18 GHz 1.15:1 @ 26.5 GHz 1.25:1 @ 40 GHz</p>	PRICE		1-24	\$150.42	25-49	\$139.89	50-99	\$129.36	100 +	\$120.34	 <table border="1"> <thead> <tr> <th colspan="2">PRICE</th> </tr> </thead> <tbody> <tr> <td>1-24</td> <td>\$229.26</td> </tr> <tr> <td>25-49</td> <td>\$213.21</td> </tr> <tr> <td>50-99</td> <td>\$197.16</td> </tr> <tr> <td>100 +</td> <td>\$183.41</td> </tr> </tbody> </table> <p><b>PRECISION</b> Model No: <b>PE9644</b> 2.92mm Male To 2.92mm Female Right Angle Max VSWR 1.40:1 @ 40 GHz</p>	PRICE		1-24	\$229.26	25-49	\$213.21	50-99	\$197.16	100 +	\$183.41
	PRICE																																											
1-24	\$150.42																																											
25-49	\$139.89																																											
50-99	\$129.36																																											
100 +	\$120.34																																											
PRICE																																												
1-24	\$231.49																																											
25-49	\$215.29																																											
50-99	\$199.08																																											
100 +	\$185.19																																											
PRICE																																												
1-24	\$150.42																																											
25-49	\$139.89																																											
50-99	\$129.36																																											
100 +	\$120.34																																											
PRICE																																												
1-24	\$229.26																																											
25-49	\$213.21																																											
50-99	\$197.16																																											
100 +	\$183.41																																											
6	 <table border="1"> <thead> <tr> <th colspan="2">PRICE</th> </tr> </thead> <tbody> <tr> <td>1-24</td> <td>\$151.54</td> </tr> <tr> <td>25-49</td> <td>\$140.93</td> </tr> <tr> <td>50-99</td> <td>\$130.32</td> </tr> <tr> <td>100 +</td> <td>\$121.23</td> </tr> </tbody> </table> <p><b>PRECISION</b> Model No: <b>PE9438</b> 2.92mm Female To 2.92mm Female, Max VSWR 1.10:1 @ 18 GHz, 1.15:1 @ 26.5 GHz 1.25:1 @ 40 GHz</p>	PRICE		1-24	\$151.54	25-49	\$140.93	50-99	\$130.32	100 +	\$121.23	 <table border="1"> <thead> <tr> <th colspan="2">PRICE</th> </tr> </thead> <tbody> <tr> <td>1-24</td> <td>\$164.21</td> </tr> <tr> <td>25-49</td> <td>\$152.72</td> </tr> <tr> <td>50-99</td> <td>\$141.22</td> </tr> <tr> <td>100 +</td> <td>\$131.37</td> </tr> </tbody> </table> <p><b>PRECISION</b> Model No: <b>PE9647</b> 2.92mm Female To 2.92mm Female Bulkhead Mounting Hole B02 Max VSWR 1.25:1 @ 40 GHz</p>	PRICE		1-24	\$164.21	25-49	\$152.72	50-99	\$141.22	100 +	\$131.37	 <table border="1"> <thead> <tr> <th colspan="2">PRICE</th> </tr> </thead> <tbody> <tr> <td>1-24</td> <td>\$162.08</td> </tr> <tr> <td>25-49</td> <td>\$150.73</td> </tr> <tr> <td>50-99</td> <td>\$139.39</td> </tr> <tr> <td>100 +</td> <td>\$129.66</td> </tr> </tbody> </table> <p><b>PRECISION</b> Model No: <b>PE9648</b> 2.92mm Female To 2.92mm Female, 4 Hole Panel Mount Max VSWR 1.35:1 @ 40 GHz Mounting Hole A01</p>	PRICE		1-24	\$162.08	25-49	\$150.73	50-99	\$139.39	100 +	\$129.66	 <table border="1"> <thead> <tr> <th colspan="2">PRICE</th> </tr> </thead> <tbody> <tr> <td>1-24</td> <td>\$235.44</td> </tr> <tr> <td>25-49</td> <td>\$218.96</td> </tr> <tr> <td>50-99</td> <td>\$202.48</td> </tr> <tr> <td>100 +</td> <td>\$188.35</td> </tr> </tbody> </table> <p><b>PRECISION</b> Model No: <b>PE9646</b> 2.92mm Female To 2.92mm Female, Right Angle Max VSWR 1.40:1 @ 40 GHz</p>	PRICE		1-24	\$235.44	25-49	\$218.96	50-99	\$202.48	100 +	\$188.35
	PRICE																																											
1-24	\$151.54																																											
25-49	\$140.93																																											
50-99	\$130.32																																											
100 +	\$121.23																																											
PRICE																																												
1-24	\$164.21																																											
25-49	\$152.72																																											
50-99	\$141.22																																											
100 +	\$131.37																																											
PRICE																																												
1-24	\$162.08																																											
25-49	\$150.73																																											
50-99	\$139.39																																											
100 +	\$129.66																																											
PRICE																																												
1-24	\$235.44																																											
25-49	\$218.96																																											
50-99	\$202.48																																											
100 +	\$188.35																																											











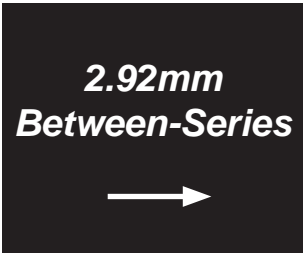



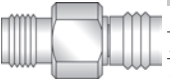
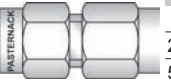
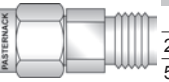
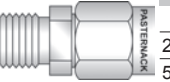
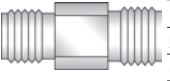

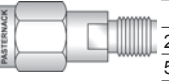

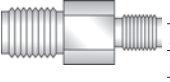
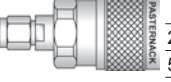
ROHS & REACH COMPLIANT. CUSTOM-LENGTH CABLE ASSEMBLIES MAY BE ORDERED ON OUR WEBSITE.

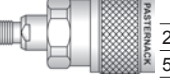
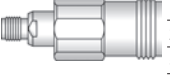

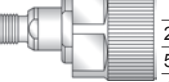
# ADAPTERS

See Adapter Locator on Pages 140-145 or the Adapter Matrix on Pages 138-139

See Page 246 for Mounting Holes

	A	B	C	D																																								
1	 <p><b>2.92mm Between-Series</b></p> <p>→</p>	 <table border="1"> <thead> <tr> <th colspan="2">PRICE</th> </tr> </thead> <tbody> <tr> <td>1-24</td> <td>\$408.87</td> </tr> <tr> <td>25-49</td> <td>\$380.25</td> </tr> <tr> <td>50-99</td> <td>\$351.63</td> </tr> <tr> <td>100 +</td> <td>\$327.10</td> </tr> </tbody> </table> <p><b>PRECISION</b></p> <p>Model No: <b>PE9457</b></p> <p>2.92mm Male To 2.4mm Male Max VSWR 1.10:1 @ 18 GHz 1.20:1 @ 26.5 GHz 1.30:1 @ 40 GHz</p>	PRICE		1-24	\$408.87	25-49	\$380.25	50-99	\$351.63	100 +	\$327.10	 <table border="1"> <thead> <tr> <th colspan="2">PRICE</th> </tr> </thead> <tbody> <tr> <td>1-24</td> <td>\$408.87</td> </tr> <tr> <td>25-49</td> <td>\$380.25</td> </tr> <tr> <td>50-99</td> <td>\$351.63</td> </tr> <tr> <td>100 +</td> <td>\$327.10</td> </tr> </tbody> </table> <p><b>PRECISION</b></p> <p>Model No: <b>PE9455</b></p> <p>2.92mm Male To 2.4mm Female Max VSWR 1.10:1 @ 18 GHz 1.20:1 @ 26.5 GHz 1.30:1 @ 40 GHz</p>	PRICE		1-24	\$408.87	25-49	\$380.25	50-99	\$351.63	100 +	\$327.10	 <table border="1"> <thead> <tr> <th colspan="2">PRICE</th> </tr> </thead> <tbody> <tr> <td>1-24</td> <td>\$404.97</td> </tr> <tr> <td>25-49</td> <td>\$376.62</td> </tr> <tr> <td>50-99</td> <td>\$348.27</td> </tr> <tr> <td>100 +</td> <td>\$323.98</td> </tr> </tbody> </table> <p><b>PRECISION</b></p> <p>Model No: <b>PE9454</b></p> <p>2.92mm Female To 2.4mm Male Max VSWR 1.10:1 @ 18 GHz 1.20:1 @ 26.5 GHz 1.30:1 @ 40 GHz</p>	PRICE		1-24	\$404.97	25-49	\$376.62	50-99	\$348.27	100 +	\$323.98										
		PRICE																																										
		1-24	\$408.87																																									
		25-49	\$380.25																																									
		50-99	\$351.63																																									
		100 +	\$327.10																																									
PRICE																																												
1-24	\$408.87																																											
25-49	\$380.25																																											
50-99	\$351.63																																											
100 +	\$327.10																																											
PRICE																																												
1-24	\$404.97																																											
25-49	\$376.62																																											
50-99	\$348.27																																											
100 +	\$323.98																																											
2	 <table border="1"> <thead> <tr> <th colspan="2">PRICE</th> </tr> </thead> <tbody> <tr> <td>1-24</td> <td>\$412.97</td> </tr> <tr> <td>25-49</td> <td>\$384.06</td> </tr> <tr> <td>50-99</td> <td>\$355.15</td> </tr> <tr> <td>100 +</td> <td>\$330.38</td> </tr> </tbody> </table> <p><b>PRECISION</b></p> <p>Model No: <b>PE9456</b></p> <p>2.92mm Female To 2.4mm Female, Max VSWR 1.10:1 @ 18 GHz, 1.20:1 @ 26.5 GHz 1.30:1 @ 40 GHz</p>	PRICE		1-24	\$412.97	25-49	\$384.06	50-99	\$355.15	100 +	\$330.38	 <table border="1"> <thead> <tr> <th colspan="2">PRICE</th> </tr> </thead> <tbody> <tr> <td>1-24</td> <td>\$400.25</td> </tr> <tr> <td>25-49</td> <td>\$372.23</td> </tr> <tr> <td>50-99</td> <td>\$344.22</td> </tr> <tr> <td>100 +</td> <td>\$320.20</td> </tr> </tbody> </table> <p><b>PRECISION</b></p> <p>Model No: <b>PE9667</b></p> <p>2.92mm Male To 1.85mm Male Max VSWR 1.25:1 @ 40 GHz</p>	PRICE		1-24	\$400.25	25-49	\$372.23	50-99	\$344.22	100 +	\$320.20	 <table border="1"> <thead> <tr> <th colspan="2">PRICE</th> </tr> </thead> <tbody> <tr> <td>1-24</td> <td>\$400.25</td> </tr> <tr> <td>25-49</td> <td>\$372.23</td> </tr> <tr> <td>50-99</td> <td>\$344.22</td> </tr> <tr> <td>100 +</td> <td>\$320.20</td> </tr> </tbody> </table> <p><b>PRECISION</b></p> <p>Model No: <b>PE9666</b></p> <p>2.92mm Male To 1.85mm Female Max VSWR 1.25:1 @ 40 GHz</p>	PRICE		1-24	\$400.25	25-49	\$372.23	50-99	\$344.22	100 +	\$320.20	 <table border="1"> <thead> <tr> <th colspan="2">PRICE</th> </tr> </thead> <tbody> <tr> <td>1-24</td> <td>\$442.61</td> </tr> <tr> <td>25-49</td> <td>\$411.63</td> </tr> <tr> <td>50-99</td> <td>\$380.64</td> </tr> <tr> <td>100 +</td> <td>\$354.09</td> </tr> </tbody> </table> <p><b>PRECISION</b></p> <p>Model No: <b>PE9665</b></p> <p>2.92mm Female To 1.85mm Male Max VSWR 1.30:1 @ 40 GHz</p>	PRICE		1-24	\$442.61	25-49	\$411.63	50-99	\$380.64	100 +	\$354.09
	PRICE																																											
	1-24	\$412.97																																										
	25-49	\$384.06																																										
	50-99	\$355.15																																										
	100 +	\$330.38																																										
PRICE																																												
1-24	\$400.25																																											
25-49	\$372.23																																											
50-99	\$344.22																																											
100 +	\$320.20																																											
PRICE																																												
1-24	\$400.25																																											
25-49	\$372.23																																											
50-99	\$344.22																																											
100 +	\$320.20																																											
PRICE																																												
1-24	\$442.61																																											
25-49	\$411.63																																											
50-99	\$380.64																																											
100 +	\$354.09																																											
3	 <table border="1"> <thead> <tr> <th colspan="2">PRICE</th> </tr> </thead> <tbody> <tr> <td>1-24</td> <td>\$393.62</td> </tr> <tr> <td>25-49</td> <td>\$366.07</td> </tr> <tr> <td>50-99</td> <td>\$338.51</td> </tr> <tr> <td>100 +</td> <td>\$314.90</td> </tr> </tbody> </table> <p><b>PRECISION</b></p> <p>Model No: <b>PE9668</b></p> <p>2.92mm Female To 1.85mm Female Max VSWR 1.25:1 @ 40 GHz</p>	PRICE		1-24	\$393.62	25-49	\$366.07	50-99	\$338.51	100 +	\$314.90	 <table border="1"> <thead> <tr> <th colspan="2">PRICE</th> </tr> </thead> <tbody> <tr> <td>1-24</td> <td>\$229.51</td> </tr> <tr> <td>25-49</td> <td>\$213.44</td> </tr> <tr> <td>50-99</td> <td>\$197.38</td> </tr> <tr> <td>100 +</td> <td>\$183.61</td> </tr> </tbody> </table> <p><b>PRECISION</b></p> <p>Model No: <b>PE9767</b></p> <p>2.92mm Male To SSMA Male Max VSWR 1.30:1 @ 40 GHz</p>	PRICE		1-24	\$229.51	25-49	\$213.44	50-99	\$197.38	100 +	\$183.61	 <table border="1"> <thead> <tr> <th colspan="2">PRICE</th> </tr> </thead> <tbody> <tr> <td>1-24</td> <td>\$164.81</td> </tr> <tr> <td>25-49</td> <td>\$153.27</td> </tr> <tr> <td>50-99</td> <td>\$141.74</td> </tr> <tr> <td>100 +</td> <td>\$131.85</td> </tr> </tbody> </table> <p><b>PRECISION</b></p> <p>Model No: <b>PE9766</b></p> <p>2.92mm Male To SSMA Female Max VSWR 1.30:1 @ 40 GHz</p>	PRICE		1-24	\$164.81	25-49	\$153.27	50-99	\$141.74	100 +	\$131.85	 <table border="1"> <thead> <tr> <th colspan="2">PRICE</th> </tr> </thead> <tbody> <tr> <td>1-24</td> <td>\$164.81</td> </tr> <tr> <td>25-49</td> <td>\$153.27</td> </tr> <tr> <td>50-99</td> <td>\$141.74</td> </tr> <tr> <td>100 +</td> <td>\$131.85</td> </tr> </tbody> </table> <p><b>PRECISION</b></p> <p>Model No: <b>PE9768</b></p> <p>2.92mm Female To SSMA Male Max VSWR 1.30:1 @ 40 GHz</p>	PRICE		1-24	\$164.81	25-49	\$153.27	50-99	\$141.74	100 +	\$131.85
	PRICE																																											
	1-24	\$393.62																																										
	25-49	\$366.07																																										
	50-99	\$338.51																																										
	100 +	\$314.90																																										
PRICE																																												
1-24	\$229.51																																											
25-49	\$213.44																																											
50-99	\$197.38																																											
100 +	\$183.61																																											
PRICE																																												
1-24	\$164.81																																											
25-49	\$153.27																																											
50-99	\$141.74																																											
100 +	\$131.85																																											
PRICE																																												
1-24	\$164.81																																											
25-49	\$153.27																																											
50-99	\$141.74																																											
100 +	\$131.85																																											
4	 <table border="1"> <thead> <tr> <th colspan="2">PRICE</th> </tr> </thead> <tbody> <tr> <td>1-24</td> <td>\$229.51</td> </tr> <tr> <td>25-49</td> <td>\$213.44</td> </tr> <tr> <td>50-99</td> <td>\$197.38</td> </tr> <tr> <td>100 +</td> <td>\$183.61</td> </tr> </tbody> </table> <p><b>PRECISION</b></p> <p>Model No: <b>PE9769</b></p> <p>2.92mm Female To SSMA Female Max VSWR 1.30:1 @ 40 GHz</p>	PRICE		1-24	\$229.51	25-49	\$213.44	50-99	\$197.38	100 +	\$183.61	 <table border="1"> <thead> <tr> <th colspan="2">PRICE</th> </tr> </thead> <tbody> <tr> <td>1-24</td> <td>\$153.01</td> </tr> <tr> <td>25-49</td> <td>\$142.30</td> </tr> <tr> <td>50-99</td> <td>\$131.59</td> </tr> <tr> <td>100 +</td> <td>\$122.41</td> </tr> </tbody> </table> <p><b>PRECISION</b></p> <p>Model No: <b>PE9661</b></p> <p>2.92mm Male To N Male Max VSWR 1.15:1 @ 18 GHz</p>	PRICE		1-24	\$153.01	25-49	\$142.30	50-99	\$131.59	100 +	\$122.41	 <table border="1"> <thead> <tr> <th colspan="2">PRICE</th> </tr> </thead> <tbody> <tr> <td>1-24</td> <td>\$247.19</td> </tr> <tr> <td>25-49</td> <td>\$229.89</td> </tr> <tr> <td>50-99</td> <td>\$212.58</td> </tr> <tr> <td>100 +</td> <td>\$197.75</td> </tr> </tbody> </table> <p><b>PRECISION</b></p> <p>Model No: <b>PE9662</b></p> <p>2.92mm Male To N Female Max VSWR 1.15:1 @ 18 GHz</p>	PRICE		1-24	\$247.19	25-49	\$229.89	50-99	\$212.58	100 +	\$197.75	 <table border="1"> <thead> <tr> <th colspan="2">PRICE</th> </tr> </thead> <tbody> <tr> <td>1-24</td> <td>\$162.08</td> </tr> <tr> <td>25-49</td> <td>\$150.73</td> </tr> <tr> <td>50-99</td> <td>\$139.39</td> </tr> <tr> <td>100 +</td> <td>\$129.66</td> </tr> </tbody> </table> <p><b>PRECISION</b></p> <p>Model No: <b>PE9663</b></p> <p>2.92mm Female To N Male Max VSWR 1.15:1 @ 18 GHz</p>	PRICE		1-24	\$162.08	25-49	\$150.73	50-99	\$139.39	100 +	\$129.66
	PRICE																																											
	1-24	\$229.51																																										
	25-49	\$213.44																																										
	50-99	\$197.38																																										
	100 +	\$183.61																																										
PRICE																																												
1-24	\$153.01																																											
25-49	\$142.30																																											
50-99	\$131.59																																											
100 +	\$122.41																																											
PRICE																																												
1-24	\$247.19																																											
25-49	\$229.89																																											
50-99	\$212.58																																											
100 +	\$197.75																																											
PRICE																																												
1-24	\$162.08																																											
25-49	\$150.73																																											
50-99	\$139.39																																											
100 +	\$129.66																																											
5	 <table border="1"> <thead> <tr> <th colspan="2">PRICE</th> </tr> </thead> <tbody> <tr> <td>1-24</td> <td>\$153.01</td> </tr> <tr> <td>25-49</td> <td>\$142.30</td> </tr> <tr> <td>50-99</td> <td>\$131.59</td> </tr> <tr> <td>100 +</td> <td>\$122.41</td> </tr> </tbody> </table> <p><b>PRECISION</b></p> <p>Model No: <b>PE9664</b></p> <p>2.92mm Female To N Female Max VSWR 1.15:1 @ 18 GHz</p>	PRICE		1-24	\$153.01	25-49	\$142.30	50-99	\$131.59	100 +	\$122.41	 <table border="1"> <thead> <tr> <th colspan="2">PRICE</th> </tr> </thead> <tbody> <tr> <td>1-24</td> <td>\$353.24</td> </tr> <tr> <td>25-49</td> <td>\$328.51</td> </tr> <tr> <td>50-99</td> <td>\$303.79</td> </tr> <tr> <td>100 +</td> <td>\$282.59</td> </tr> </tbody> </table> <p><b>PRECISION</b></p> <p>Model No: <b>PE9460</b></p> <p>2.92mm Male To 7mm Max VSWR 1.10:1 @ 18 GHz</p>	PRICE		1-24	\$353.24	25-49	\$328.51	50-99	\$303.79	100 +	\$282.59	 <table border="1"> <thead> <tr> <th colspan="2">PRICE</th> </tr> </thead> <tbody> <tr> <td>1-24</td> <td>\$353.24</td> </tr> <tr> <td>25-49</td> <td>\$328.51</td> </tr> <tr> <td>50-99</td> <td>\$303.79</td> </tr> <tr> <td>100 +</td> <td>\$282.59</td> </tr> </tbody> </table> <p><b>PRECISION</b></p> <p>Model No: <b>PE9461</b></p> <p>2.92mm Female To 7mm Max VSWR 1.10:1 @ 18 GHz</p>	PRICE		1-24	\$353.24	25-49	\$328.51	50-99	\$303.79	100 +	\$282.59	 <table border="1"> <thead> <tr> <th colspan="2">PRICE</th> </tr> </thead> <tbody> <tr> <td>1-24</td> <td>\$529.80</td> </tr> <tr> <td>25-49</td> <td>\$492.71</td> </tr> <tr> <td>50-99</td> <td>\$455.63</td> </tr> <tr> <td>100 +</td> <td>\$423.84</td> </tr> </tbody> </table> <p><b>PRECISION</b></p> <p>Model No: <b>PE9781</b></p> <p>2.92mm Female To Mini SMP Male Max VSWR 1.30:1 @ 40 GHz</p>	PRICE		1-24	\$529.80	25-49	\$492.71	50-99	\$455.63	100 +	\$423.84
	PRICE																																											
	1-24	\$153.01																																										
	25-49	\$142.30																																										
	50-99	\$131.59																																										
	100 +	\$122.41																																										
PRICE																																												
1-24	\$353.24																																											
25-49	\$328.51																																											
50-99	\$303.79																																											
100 +	\$282.59																																											
PRICE																																												
1-24	\$353.24																																											
25-49	\$328.51																																											
50-99	\$303.79																																											
100 +	\$282.59																																											
PRICE																																												
1-24	\$529.80																																											
25-49	\$492.71																																											
50-99	\$455.63																																											
100 +	\$423.84																																											
6	 <table border="1"> <thead> <tr> <th colspan="2">PRICE</th> </tr> </thead> <tbody> <tr> <td>1-24</td> <td>\$529.80</td> </tr> <tr> <td>25-49</td> <td>\$492.71</td> </tr> <tr> <td>50-99</td> <td>\$455.63</td> </tr> <tr> <td>100 +</td> <td>\$423.84</td> </tr> </tbody> </table> <p><b>PRECISION</b></p> <p>Model No: <b>PE9782</b></p> <p>2.92mm Female To Mini SMP Female Max VSWR 1.30:1 @ 40 GHz</p>	PRICE		1-24	\$529.80	25-49	\$492.71	50-99	\$455.63	100 +	\$423.84	 <p><b>2.4mm In-Series</b></p> <p>→</p>	 <table border="1"> <thead> <tr> <th colspan="2">PRICE</th> </tr> </thead> <tbody> <tr> <td>1-24</td> <td>\$408.87</td> </tr> <tr> <td>25-49</td> <td>\$380.25</td> </tr> <tr> <td>50-99</td> <td>\$351.63</td> </tr> <tr> <td>100 +</td> <td>\$327.10</td> </tr> </tbody> </table> <p><b>PRECISION</b></p> <p>Model No: <b>PE9451</b></p> <p>2.4mm Male To 2.4mm Male Max VSWR 1.10:1 @ 18 GHz 1.20:1 @ 26.5 GHz 1.30:1 @ 50 GHz</p>	PRICE		1-24	\$408.87	25-49	\$380.25	50-99	\$351.63	100 +	\$327.10	 <table border="1"> <thead> <tr> <th colspan="2">PRICE</th> </tr> </thead> <tbody> <tr> <td>1-24</td> <td>\$408.87</td> </tr> <tr> <td>25-49</td> <td>\$380.25</td> </tr> <tr> <td>50-99</td> <td>\$351.63</td> </tr> <tr> <td>100 +</td> <td>\$327.10</td> </tr> </tbody> </table> <p><b>PRECISION</b></p> <p>Model No: <b>PE9452</b></p> <p>2.4mm Male To 2.4mm Female Max VSWR 1.10:1 @ 18 GHz 1.20:1 @ 26.5 GHz 1.30:1 @ 50 GHz</p>	PRICE		1-24	\$408.87	25-49	\$380.25	50-99	\$351.63	100 +	\$327.10										
	PRICE																																											
	1-24	\$529.80																																										
	25-49	\$492.71																																										
	50-99	\$455.63																																										
	100 +	\$423.84																																										
PRICE																																												
1-24	\$408.87																																											
25-49	\$380.25																																											
50-99	\$351.63																																											
100 +	\$327.10																																											
PRICE																																												
1-24	\$408.87																																											
25-49	\$380.25																																											
50-99	\$351.63																																											
100 +	\$327.10																																											

Adapters

See Our Website For Real-Time Stock Availability!



Free Freight Available  
via UPS Ground  
to USA & Canada



Real-Time Stock  
Levels & Pricing  
On Our Website



Toll-Free Technical  
Support  
(866) 727-8376













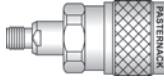
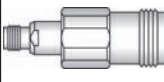

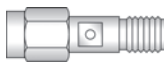
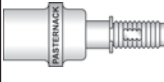
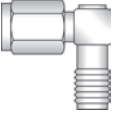
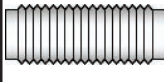
Same-Day Shipping,  
Even Custom  
Cable Assemblies

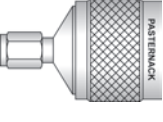
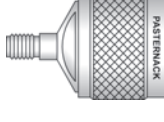

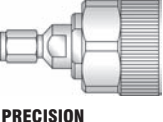
# ADAPTERS

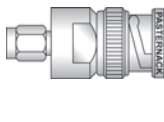
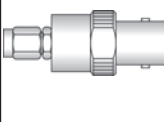
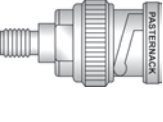
See Adapter Locator on Pages 140-145 or the Adapter Matrix on Pages 138-139

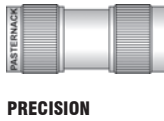
See Page 246 for Mounting Holes

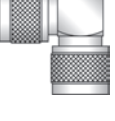
	A	B	C	D																																								
1	 <table border="1"> <thead> <tr> <th colspan="2">PRICE</th> </tr> </thead> <tbody> <tr> <td>1-24</td> <td>\$153.01</td> </tr> <tr> <td>25-49</td> <td>\$142.30</td> </tr> <tr> <td>50-99</td> <td>\$131.59</td> </tr> <tr> <td>100 +</td> <td>\$122.41</td> </tr> </tbody> </table> <p><b>PRECISION</b> Model No: <b>PE9720</b> 1.85mm Female To N Male Max VSWR 1.25:1 @ 18 GHz</p>	PRICE		1-24	\$153.01	25-49	\$142.30	50-99	\$131.59	100 +	\$122.41	 <table border="1"> <thead> <tr> <th colspan="2">PRICE</th> </tr> </thead> <tbody> <tr> <td>1-24</td> <td>\$153.01</td> </tr> <tr> <td>25-49</td> <td>\$142.30</td> </tr> <tr> <td>50-99</td> <td>\$131.59</td> </tr> <tr> <td>100 +</td> <td>\$122.41</td> </tr> </tbody> </table> <p><b>PRECISION</b> Model No: <b>PE9721</b> 1.85mm Female To N Female Max VSWR 1.25:1 @ 18 GHz</p>	PRICE		1-24	\$153.01	25-49	\$142.30	50-99	\$131.59	100 +	\$122.41	<p><b>SSMA</b> <i>In-Series</i></p> 		 <table border="1"> <thead> <tr> <th colspan="2">PRICE</th> </tr> </thead> <tbody> <tr> <td>1-24</td> <td>\$83.50</td> </tr> <tr> <td>25-49</td> <td>\$77.66</td> </tr> <tr> <td>50-99</td> <td>\$71.81</td> </tr> <tr> <td>100 +</td> <td>\$66.80</td> </tr> </tbody> </table> <p>Model No: <b>PE9357</b> SSMA Male To SSMA Male</p>	PRICE		1-24	\$83.50	25-49	\$77.66	50-99	\$71.81	100 +	\$66.80									
	PRICE																																											
1-24	\$153.01																																											
25-49	\$142.30																																											
50-99	\$131.59																																											
100 +	\$122.41																																											
PRICE																																												
1-24	\$153.01																																											
25-49	\$142.30																																											
50-99	\$131.59																																											
100 +	\$122.41																																											
PRICE																																												
1-24	\$83.50																																											
25-49	\$77.66																																											
50-99	\$71.81																																											
100 +	\$66.80																																											
2	 <table border="1"> <thead> <tr> <th colspan="2">PRICE</th> </tr> </thead> <tbody> <tr> <td>1-24</td> <td>\$47.12</td> </tr> <tr> <td>25-49</td> <td>\$43.82</td> </tr> <tr> <td>50-99</td> <td>\$40.52</td> </tr> <tr> <td>100 +</td> <td>\$37.70</td> </tr> </tbody> </table> <p>Model No: <b>PE9358</b> SSMA Male To SSMA Female</p>	PRICE		1-24	\$47.12	25-49	\$43.82	50-99	\$40.52	100 +	\$37.70	 <table border="1"> <thead> <tr> <th colspan="2">PRICE</th> </tr> </thead> <tbody> <tr> <td>1-24</td> <td>\$116.78</td> </tr> <tr> <td>25-49</td> <td>\$108.61</td> </tr> <tr> <td>50-99</td> <td>\$100.43</td> </tr> <tr> <td>100 +</td> <td>\$93.42</td> </tr> </tbody> </table> <p>Model No: <b>PE9685</b> SSMA Male Quick Disconnect To SSMA Female</p>	PRICE		1-24	\$116.78	25-49	\$108.61	50-99	\$100.43	100 +	\$93.42	 <table border="1"> <thead> <tr> <th colspan="2">PRICE</th> </tr> </thead> <tbody> <tr> <td>1-24</td> <td>\$60.54</td> </tr> <tr> <td>25-49</td> <td>\$56.30</td> </tr> <tr> <td>50-99</td> <td>\$52.06</td> </tr> <tr> <td>100 +</td> <td>\$48.43</td> </tr> </tbody> </table> <p>Model No: <b>PE9334</b> SSMA Male To SSMA Female Right Angle</p>	PRICE		1-24	\$60.54	25-49	\$56.30	50-99	\$52.06	100 +	\$48.43	 <table border="1"> <thead> <tr> <th colspan="2">PRICE</th> </tr> </thead> <tbody> <tr> <td>1-24</td> <td>\$47.12</td> </tr> <tr> <td>25-49</td> <td>\$43.82</td> </tr> <tr> <td>50-99</td> <td>\$40.52</td> </tr> <tr> <td>100 +</td> <td>\$37.70</td> </tr> </tbody> </table> <p>Model No: <b>PE9192</b> SSMA Female To SSMA Female</p>	PRICE		1-24	\$47.12	25-49	\$43.82	50-99	\$40.52	100 +	\$37.70
	PRICE																																											
1-24	\$47.12																																											
25-49	\$43.82																																											
50-99	\$40.52																																											
100 +	\$37.70																																											
PRICE																																												
1-24	\$116.78																																											
25-49	\$108.61																																											
50-99	\$100.43																																											
100 +	\$93.42																																											
PRICE																																												
1-24	\$60.54																																											
25-49	\$56.30																																											
50-99	\$52.06																																											
100 +	\$48.43																																											
PRICE																																												
1-24	\$47.12																																											
25-49	\$43.82																																											
50-99	\$40.52																																											
100 +	\$37.70																																											
3	 <table border="1"> <thead> <tr> <th colspan="2">PRICE</th> </tr> </thead> <tbody> <tr> <td>1-24</td> <td>\$46.21</td> </tr> <tr> <td>25-49</td> <td>\$42.98</td> </tr> <tr> <td>50-99</td> <td>\$39.74</td> </tr> <tr> <td>100 +</td> <td>\$36.97</td> </tr> </tbody> </table> <p>Model No: <b>PE9189</b> SSMA Female To SSMA Female Bulkhead Mounting Hole B01</p>	PRICE		1-24	\$46.21	25-49	\$42.98	50-99	\$39.74	100 +	\$36.97	<p><b>SSMA</b> <i>Between-Series</i></p> 		 <table border="1"> <thead> <tr> <th colspan="2">PRICE</th> </tr> </thead> <tbody> <tr> <td>1-24</td> <td>\$57.76</td> </tr> <tr> <td>25-49</td> <td>\$53.72</td> </tr> <tr> <td>50-99</td> <td>\$49.67</td> </tr> <tr> <td>100 +</td> <td>\$46.21</td> </tr> </tbody> </table> <p>Model No: <b>PE9351</b> SSMA Male To N Male</p>	PRICE		1-24	\$57.76	25-49	\$53.72	50-99	\$49.67	100 +	\$46.21																				
	PRICE																																											
1-24	\$46.21																																											
25-49	\$42.98																																											
50-99	\$39.74																																											
100 +	\$36.97																																											
PRICE																																												
1-24	\$57.76																																											
25-49	\$53.72																																											
50-99	\$49.67																																											
100 +	\$46.21																																											
4	 <table border="1"> <thead> <tr> <th colspan="2">PRICE</th> </tr> </thead> <tbody> <tr> <td>1-24</td> <td>\$57.76</td> </tr> <tr> <td>25-49</td> <td>\$53.72</td> </tr> <tr> <td>50-99</td> <td>\$49.67</td> </tr> <tr> <td>100 +</td> <td>\$46.21</td> </tr> </tbody> </table> <p>Model No: <b>PE9352</b> SSMA Female To N Male</p>	PRICE		1-24	\$57.76	25-49	\$53.72	50-99	\$49.67	100 +	\$46.21	 <table border="1"> <thead> <tr> <th colspan="2">PRICE</th> </tr> </thead> <tbody> <tr> <td>1-24</td> <td>\$58.87</td> </tr> <tr> <td>25-49</td> <td>\$54.75</td> </tr> <tr> <td>50-99</td> <td>\$50.63</td> </tr> <tr> <td>100 +</td> <td>\$47.10</td> </tr> </tbody> </table> <p>Model No: <b>PE9354</b> SSMA Female To N Female</p>	PRICE		1-24	\$58.87	25-49	\$54.75	50-99	\$50.63	100 +	\$47.10	 <table border="1"> <thead> <tr> <th colspan="2">PRICE</th> </tr> </thead> <tbody> <tr> <td>1-24</td> <td>\$247.25</td> </tr> <tr> <td>25-49</td> <td>\$229.94</td> </tr> <tr> <td>50-99</td> <td>\$212.64</td> </tr> <tr> <td>100 +</td> <td>\$197.80</td> </tr> </tbody> </table> <p><b>PRECISION</b> Model No: <b>PE9355</b> SSMA Male To 7mm Max VSWR 1.15:1 @ 18 GHz</p>	PRICE		1-24	\$247.25	25-49	\$229.94	50-99	\$212.64	100 +	\$197.80	 <table border="1"> <thead> <tr> <th colspan="2">PRICE</th> </tr> </thead> <tbody> <tr> <td>1-24</td> <td>\$247.25</td> </tr> <tr> <td>25-49</td> <td>\$229.94</td> </tr> <tr> <td>50-99</td> <td>\$212.64</td> </tr> <tr> <td>100 +</td> <td>\$197.80</td> </tr> </tbody> </table> <p><b>PRECISION</b> Model No: <b>PE9356</b> SSMA Female To 7mm Max VSWR 1.15:1 @ 18 GHz</p>	PRICE		1-24	\$247.25	25-49	\$229.94	50-99	\$212.64	100 +	\$197.80
	PRICE																																											
1-24	\$57.76																																											
25-49	\$53.72																																											
50-99	\$49.67																																											
100 +	\$46.21																																											
PRICE																																												
1-24	\$58.87																																											
25-49	\$54.75																																											
50-99	\$50.63																																											
100 +	\$47.10																																											
PRICE																																												
1-24	\$247.25																																											
25-49	\$229.94																																											
50-99	\$212.64																																											
100 +	\$197.80																																											
PRICE																																												
1-24	\$247.25																																											
25-49	\$229.94																																											
50-99	\$212.64																																											
100 +	\$197.80																																											
5	 <table border="1"> <thead> <tr> <th colspan="2">PRICE</th> </tr> </thead> <tbody> <tr> <td>1-24</td> <td>\$84.86</td> </tr> <tr> <td>25-49</td> <td>\$78.92</td> </tr> <tr> <td>50-99</td> <td>\$72.98</td> </tr> <tr> <td>100 +</td> <td>\$67.89</td> </tr> </tbody> </table> <p>Model No: <b>PE9213</b> SSMA Male To BNC Male</p>	PRICE		1-24	\$84.86	25-49	\$78.92	50-99	\$72.98	100 +	\$67.89	 <table border="1"> <thead> <tr> <th colspan="2">PRICE</th> </tr> </thead> <tbody> <tr> <td>1-24</td> <td>\$94.08</td> </tr> <tr> <td>25-49</td> <td>\$87.49</td> </tr> <tr> <td>50-99</td> <td>\$80.91</td> </tr> <tr> <td>100 +</td> <td>\$75.26</td> </tr> </tbody> </table> <p>Model No: <b>PE9250</b> SSMA Male To BNC Female</p>	PRICE		1-24	\$94.08	25-49	\$87.49	50-99	\$80.91	100 +	\$75.26	 <table border="1"> <thead> <tr> <th colspan="2">PRICE</th> </tr> </thead> <tbody> <tr> <td>1-24</td> <td>\$56.24</td> </tr> <tr> <td>25-49</td> <td>\$52.30</td> </tr> <tr> <td>50-99</td> <td>\$48.37</td> </tr> <tr> <td>100 +</td> <td>\$44.99</td> </tr> </tbody> </table> <p>Model No: <b>PE9191</b> SSMA Female To BNC Male</p>	PRICE		1-24	\$56.24	25-49	\$52.30	50-99	\$48.37	100 +	\$44.99	<p><b>N</b> <i>In-Series</i></p> 										
	PRICE																																											
1-24	\$84.86																																											
25-49	\$78.92																																											
50-99	\$72.98																																											
100 +	\$67.89																																											
PRICE																																												
1-24	\$94.08																																											
25-49	\$87.49																																											
50-99	\$80.91																																											
100 +	\$75.26																																											
PRICE																																												
1-24	\$56.24																																											
25-49	\$52.30																																											
50-99	\$48.37																																											
100 +	\$44.99																																											
6	 <table border="1"> <thead> <tr> <th colspan="2">PRICE</th> </tr> </thead> <tbody> <tr> <td>1-24</td> <td>\$70.88</td> </tr> <tr> <td>25-49</td> <td>\$65.92</td> </tr> <tr> <td>50-99</td> <td>\$60.96</td> </tr> <tr> <td>100 +</td> <td>\$56.70</td> </tr> </tbody> </table> <p><b>PRECISION</b> Model No: <b>PE9427</b> N Male To N Male Max VSWR 1.15:1 @ 18 GHz</p>	PRICE		1-24	\$70.88	25-49	\$65.92	50-99	\$60.96	100 +	\$56.70	 <table border="1"> <thead> <tr> <th colspan="2">PRICE</th> </tr> </thead> <tbody> <tr> <td>1-24</td> <td>\$70.00</td> </tr> <tr> <td>25-49</td> <td>\$65.10</td> </tr> <tr> <td>50-99</td> <td>\$60.20</td> </tr> <tr> <td>100 +</td> <td>\$56.00</td> </tr> </tbody> </table> <p><b>PRECISION NEW</b> Model No: <b>PE91034</b> N Male To N Male Low PIM, Low VSWR</p>	PRICE		1-24	\$70.00	25-49	\$65.10	50-99	\$60.20	100 +	\$56.00	 <table border="1"> <thead> <tr> <th colspan="2">PRICE</th> </tr> </thead> <tbody> <tr> <td>1-24</td> <td>\$11.70</td> </tr> <tr> <td>25-49</td> <td>\$10.88</td> </tr> <tr> <td>50-99</td> <td>\$10.06</td> </tr> <tr> <td>100 +</td> <td>\$9.36</td> </tr> </tbody> </table> <p>Model No: <b>PE9007</b> N Male To N Male</p>	PRICE		1-24	\$11.70	25-49	\$10.88	50-99	\$10.06	100 +	\$9.36	 <table border="1"> <thead> <tr> <th colspan="2">PRICE</th> </tr> </thead> <tbody> <tr> <td>1-24</td> <td>\$26.19</td> </tr> <tr> <td>25-49</td> <td>\$24.36</td> </tr> <tr> <td>50-99</td> <td>\$22.52</td> </tr> <tr> <td>100 +</td> <td>\$20.95</td> </tr> </tbody> </table> <p>Model No: <b>PE9198</b> N Male To N Male Right Angle</p>	PRICE		1-24	\$26.19	25-49	\$24.36	50-99	\$22.52	100 +	\$20.95
	PRICE																																											
1-24	\$70.88																																											
25-49	\$65.92																																											
50-99	\$60.96																																											
100 +	\$56.70																																											
PRICE																																												
1-24	\$70.00																																											
25-49	\$65.10																																											
50-99	\$60.20																																											
100 +	\$56.00																																											
PRICE																																												
1-24	\$11.70																																											
25-49	\$10.88																																											
50-99	\$10.06																																											
100 +	\$9.36																																											
PRICE																																												
1-24	\$26.19																																											
25-49	\$24.36																																											
50-99	\$22.52																																											
100 +	\$20.95																																											

Adapters

See Our Website For Real-Time Stock Availability!











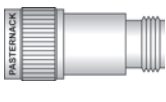
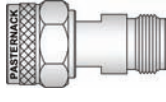
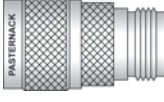

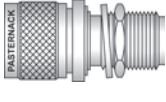
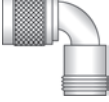



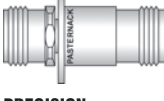

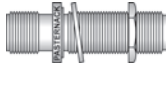
# ADAPTERS

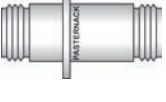
See Adapter Locator on Pages 140-145 or the Adapter Matrix on Pages 138-139

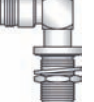
See Page 246 for Mounting Holes

Adapters

See Our Website For Real-Time Stock Availability!

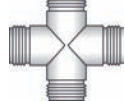
	A	B	C	D																																								
1	 <table border="1"> <thead> <tr> <th colspan="2">PRICE</th> </tr> </thead> <tbody> <tr> <td>1-24</td> <td>\$99.81</td> </tr> <tr> <td>25-49</td> <td>\$92.82</td> </tr> <tr> <td>50-99</td> <td>\$85.84</td> </tr> <tr> <td>100 +</td> <td>\$79.85</td> </tr> </tbody> </table> <p><b>PRECISION</b></p> <p>Model No: <b>PE9426</b></p> <p>N Male To N Female Max VSWR 1.15:1 @ 18 GHz</p>	PRICE		1-24	\$99.81	25-49	\$92.82	50-99	\$85.84	100 +	\$79.85	 <table border="1"> <thead> <tr> <th colspan="2">PRICE</th> </tr> </thead> <tbody> <tr> <td>1-24</td> <td>\$65.00</td> </tr> <tr> <td>25-49</td> <td>\$60.45</td> </tr> <tr> <td>50-99</td> <td>\$55.90</td> </tr> <tr> <td>100 +</td> <td>\$52.00</td> </tr> </tbody> </table> <p><b>PRECISION NEW</b></p> <p>Model No: <b>PE91040</b></p> <p>N Male To N Female Low PIM, Low VSWR</p>	PRICE		1-24	\$65.00	25-49	\$60.45	50-99	\$55.90	100 +	\$52.00	 <table border="1"> <thead> <tr> <th colspan="2">PRICE</th> </tr> </thead> <tbody> <tr> <td>1-24</td> <td>\$20.67</td> </tr> <tr> <td>25-49</td> <td>\$19.22</td> </tr> <tr> <td>50-99</td> <td>\$17.78</td> </tr> <tr> <td>100 +</td> <td>\$16.54</td> </tr> </tbody> </table> <p>Model No: <b>PE9311</b></p> <p>N Male To N Female</p>	PRICE		1-24	\$20.67	25-49	\$19.22	50-99	\$17.78	100 +	\$16.54	 <table border="1"> <thead> <tr> <th colspan="2">PRICE</th> </tr> </thead> <tbody> <tr> <td>1-24</td> <td>\$127.32</td> </tr> <tr> <td>25-49</td> <td>\$118.41</td> </tr> <tr> <td>50-99</td> <td>\$109.50</td> </tr> <tr> <td>100 +</td> <td>\$101.86</td> </tr> </tbody> </table> <p>Model No: <b>PE9547</b></p> <p>N Male Quick Disconnect To N Female</p>	PRICE		1-24	\$127.32	25-49	\$118.41	50-99	\$109.50	100 +	\$101.86
	PRICE																																											
1-24	\$99.81																																											
25-49	\$92.82																																											
50-99	\$85.84																																											
100 +	\$79.85																																											
PRICE																																												
1-24	\$65.00																																											
25-49	\$60.45																																											
50-99	\$55.90																																											
100 +	\$52.00																																											
PRICE																																												
1-24	\$20.67																																											
25-49	\$19.22																																											
50-99	\$17.78																																											
100 +	\$16.54																																											
PRICE																																												
1-24	\$127.32																																											
25-49	\$118.41																																											
50-99	\$109.50																																											
100 +	\$101.86																																											
2	 <table border="1"> <thead> <tr> <th colspan="2">PRICE</th> </tr> </thead> <tbody> <tr> <td>1-24</td> <td>\$33.08</td> </tr> <tr> <td>25-49</td> <td>\$30.76</td> </tr> <tr> <td>50-99</td> <td>\$28.45</td> </tr> <tr> <td>100 +</td> <td>\$26.46</td> </tr> </tbody> </table> <p>Model No: <b>PE9595</b></p> <p>N Male To N Female Bulkhead Mounting Hole G01</p>	PRICE		1-24	\$33.08	25-49	\$30.76	50-99	\$28.45	100 +	\$26.46	 <table border="1"> <thead> <tr> <th colspan="2">PRICE</th> </tr> </thead> <tbody> <tr> <td>1-24</td> <td>\$177.18</td> </tr> <tr> <td>25-49</td> <td>\$164.78</td> </tr> <tr> <td>50-99</td> <td>\$152.37</td> </tr> <tr> <td>100 +</td> <td>\$141.74</td> </tr> </tbody> </table> <p><b>PRECISION</b></p> <p>Model No: <b>PE9515</b></p> <p>N Male To N Female Radius Right Angle Max VSWR 1.20:1 @ 11 GHz 1.30:1 @ 18 GHz</p>	PRICE		1-24	\$177.18	25-49	\$164.78	50-99	\$152.37	100 +	\$141.74	 <table border="1"> <thead> <tr> <th colspan="2">PRICE</th> </tr> </thead> <tbody> <tr> <td>1-24</td> <td>\$17.52</td> </tr> <tr> <td>25-49</td> <td>\$16.29</td> </tr> <tr> <td>50-99</td> <td>\$15.07</td> </tr> <tr> <td>100 +</td> <td>\$14.02</td> </tr> </tbody> </table> <p>Model No: <b>PE9086</b></p> <p>N Male To N Female Right Angle</p>	PRICE		1-24	\$17.52	25-49	\$16.29	50-99	\$15.07	100 +	\$14.02	 <table border="1"> <thead> <tr> <th colspan="2">PRICE</th> </tr> </thead> <tbody> <tr> <td>1-24</td> <td>\$78.23</td> </tr> <tr> <td>25-49</td> <td>\$72.75</td> </tr> <tr> <td>50-99</td> <td>\$67.28</td> </tr> <tr> <td>100 +</td> <td>\$62.58</td> </tr> </tbody> </table> <p><b>PRECISION</b></p> <p>Model No: <b>PE9428</b></p> <p>N Female To N Female Max VSWR 1.15:1 @ 18 GHz</p>	PRICE		1-24	\$78.23	25-49	\$72.75	50-99	\$67.28	100 +	\$62.58
	PRICE																																											
1-24	\$33.08																																											
25-49	\$30.76																																											
50-99	\$28.45																																											
100 +	\$26.46																																											
PRICE																																												
1-24	\$177.18																																											
25-49	\$164.78																																											
50-99	\$152.37																																											
100 +	\$141.74																																											
PRICE																																												
1-24	\$17.52																																											
25-49	\$16.29																																											
50-99	\$15.07																																											
100 +	\$14.02																																											
PRICE																																												
1-24	\$78.23																																											
25-49	\$72.75																																											
50-99	\$67.28																																											
100 +	\$62.58																																											
3	 <table border="1"> <thead> <tr> <th colspan="2">PRICE</th> </tr> </thead> <tbody> <tr> <td>1-24</td> <td>\$35.00</td> </tr> <tr> <td>25-49</td> <td>\$32.55</td> </tr> <tr> <td>50-99</td> <td>\$30.10</td> </tr> <tr> <td>100 +</td> <td>\$28.00</td> </tr> </tbody> </table> <p><b>PRECISION NEW</b></p> <p>Model No: <b>PE91035</b></p> <p>N Female To N Female Low PIM, Low VSWR</p>	PRICE		1-24	\$35.00	25-49	\$32.55	50-99	\$30.10	100 +	\$28.00	 <table border="1"> <thead> <tr> <th colspan="2">PRICE</th> </tr> </thead> <tbody> <tr> <td>1-24</td> <td>\$143.23</td> </tr> <tr> <td>25-49</td> <td>\$133.20</td> </tr> <tr> <td>50-99</td> <td>\$123.18</td> </tr> <tr> <td>100 +</td> <td>\$114.58</td> </tr> </tbody> </table> <p><b>PRECISION</b></p> <p>Model No: <b>PE9500</b></p> <p>N Female To N Female Bulkhead Max VSWR 1.15:1 @ 18 GHz Mounting Hole G01</p>	PRICE		1-24	\$143.23	25-49	\$133.20	50-99	\$123.18	100 +	\$114.58	 <table border="1"> <thead> <tr> <th colspan="2">PRICE</th> </tr> </thead> <tbody> <tr> <td>1-24</td> <td>\$92.56</td> </tr> <tr> <td>25-49</td> <td>\$86.08</td> </tr> <tr> <td>50-99</td> <td>\$79.60</td> </tr> <tr> <td>100 +</td> <td>\$74.05</td> </tr> </tbody> </table> <p><b>PRECISION</b></p> <p>Model No: <b>PE9429</b></p> <p>N Female To N Female Panel Mount Max VSWR 1.15:1 @ 18 GHz Mounting Hole A05</p>	PRICE		1-24	\$92.56	25-49	\$86.08	50-99	\$79.60	100 +	\$74.05	 <table border="1"> <thead> <tr> <th colspan="2">PRICE</th> </tr> </thead> <tbody> <tr> <td>1-24</td> <td>\$11.70</td> </tr> <tr> <td>25-49</td> <td>\$10.88</td> </tr> <tr> <td>50-99</td> <td>\$10.06</td> </tr> <tr> <td>100 +</td> <td>\$9.36</td> </tr> </tbody> </table> <p>Model No: <b>PE9006</b></p> <p>N Female To N Female</p>	PRICE		1-24	\$11.70	25-49	\$10.88	50-99	\$10.06	100 +	\$9.36
	PRICE																																											
1-24	\$35.00																																											
25-49	\$32.55																																											
50-99	\$30.10																																											
100 +	\$28.00																																											
PRICE																																												
1-24	\$143.23																																											
25-49	\$133.20																																											
50-99	\$123.18																																											
100 +	\$114.58																																											
PRICE																																												
1-24	\$92.56																																											
25-49	\$86.08																																											
50-99	\$79.60																																											
100 +	\$74.05																																											
PRICE																																												
1-24	\$11.70																																											
25-49	\$10.88																																											
50-99	\$10.06																																											
100 +	\$9.36																																											
4	 <table border="1"> <thead> <tr> <th colspan="2">PRICE</th> </tr> </thead> <tbody> <tr> <td>1-24</td> <td>\$18.46</td> </tr> <tr> <td>25-49</td> <td>\$17.17</td> </tr> <tr> <td>50-99</td> <td>\$15.88</td> </tr> <tr> <td>100 +</td> <td>\$14.77</td> </tr> </tbody> </table> <p>Model No: <b>PE9128</b></p> <p>N Female To N Female Bulkhead Hermetically Sealed Mounting Hole G01</p>	PRICE		1-24	\$18.46	25-49	\$17.17	50-99	\$15.88	100 +	\$14.77	 <table border="1"> <thead> <tr> <th colspan="2">PRICE</th> </tr> </thead> <tbody> <tr> <td>1-24</td> <td>\$56.80</td> </tr> <tr> <td>25-49</td> <td>\$52.82</td> </tr> <tr> <td>50-99</td> <td>\$48.85</td> </tr> <tr> <td>100 +</td> <td>\$45.44</td> </tr> </tbody> </table> <p>Model No: <b>PE9383</b></p> <p>N Female To N Female Bulkhead Hermetically Sealed For A 1" Max Panel Mounting Hole G01</p>	PRICE		1-24	\$56.80	25-49	\$52.82	50-99	\$48.85	100 +	\$45.44	 <table border="1"> <thead> <tr> <th colspan="2">PRICE</th> </tr> </thead> <tbody> <tr> <td>1-24</td> <td>\$31.36</td> </tr> <tr> <td>25-49</td> <td>\$29.16</td> </tr> <tr> <td>50-99</td> <td>\$26.97</td> </tr> <tr> <td>100 +</td> <td>\$25.09</td> </tr> </tbody> </table> <p>Model No: <b>PE9382</b></p> <p>N Female To N Female Bulkhead Isolated Ground Mounting Hole G01</p>	PRICE		1-24	\$31.36	25-49	\$29.16	50-99	\$26.97	100 +	\$25.09	 <table border="1"> <thead> <tr> <th colspan="2">PRICE</th> </tr> </thead> <tbody> <tr> <td>1-24</td> <td>\$22.92</td> </tr> <tr> <td>25-49</td> <td>\$21.32</td> </tr> <tr> <td>50-99</td> <td>\$19.71</td> </tr> <tr> <td>100 +</td> <td>\$18.34</td> </tr> </tbody> </table> <p>Model No: <b>PE9173</b></p> <p>N Female To N Female Panel Mount Mounting Hole A05</p>	PRICE		1-24	\$22.92	25-49	\$21.32	50-99	\$19.71	100 +	\$18.34
	PRICE																																											
1-24	\$18.46																																											
25-49	\$17.17																																											
50-99	\$15.88																																											
100 +	\$14.77																																											
PRICE																																												
1-24	\$56.80																																											
25-49	\$52.82																																											
50-99	\$48.85																																											
100 +	\$45.44																																											
PRICE																																												
1-24	\$31.36																																											
25-49	\$29.16																																											
50-99	\$26.97																																											
100 +	\$25.09																																											
PRICE																																												
1-24	\$22.92																																											
25-49	\$21.32																																											
50-99	\$19.71																																											
100 +	\$18.34																																											
5	 <table border="1"> <thead> <tr> <th colspan="2">PRICE</th> </tr> </thead> <tbody> <tr> <td>1-24</td> <td>\$34.71</td> </tr> <tr> <td>25-49</td> <td>\$32.28</td> </tr> <tr> <td>50-99</td> <td>\$29.85</td> </tr> <tr> <td>100 +</td> <td>\$27.77</td> </tr> </tbody> </table> <p>Model No: <b>PE9359</b></p> <p>N Female To N Female Right Angle</p>	PRICE		1-24	\$34.71	25-49	\$32.28	50-99	\$29.85	100 +	\$27.77	 <table border="1"> <thead> <tr> <th colspan="2">PRICE</th> </tr> </thead> <tbody> <tr> <td>1-24</td> <td>\$57.81</td> </tr> <tr> <td>25-49</td> <td>\$53.76</td> </tr> <tr> <td>50-99</td> <td>\$49.72</td> </tr> <tr> <td>100 +</td> <td>\$46.25</td> </tr> </tbody> </table> <p>Model No: <b>PE9541</b></p> <p>N Female To N Female Bulkhead Right Angle Mounting Hole G01</p>	PRICE		1-24	\$57.81	25-49	\$53.76	50-99	\$49.72	100 +	\$46.25	 <table border="1"> <thead> <tr> <th colspan="2">PRICE</th> </tr> </thead> <tbody> <tr> <td>1-24</td> <td>\$46.21</td> </tr> <tr> <td>25-49</td> <td>\$42.98</td> </tr> <tr> <td>50-99</td> <td>\$39.74</td> </tr> <tr> <td>100 +</td> <td>\$36.97</td> </tr> </tbody> </table> <p>Model No: <b>PE9390</b></p> <p>N "T" Male-Male-Male</p>	PRICE		1-24	\$46.21	25-49	\$42.98	50-99	\$39.74	100 +	\$36.97	 <table border="1"> <thead> <tr> <th colspan="2">PRICE</th> </tr> </thead> <tbody> <tr> <td>1-24</td> <td>\$24.07</td> </tr> <tr> <td>25-49</td> <td>\$22.39</td> </tr> <tr> <td>50-99</td> <td>\$20.70</td> </tr> <tr> <td>100 +</td> <td>\$19.26</td> </tr> </tbody> </table> <p>Model No: <b>PE9102</b></p> <p>N "T" Female-Male-Female</p>	PRICE		1-24	\$24.07	25-49	\$22.39	50-99	\$20.70	100 +	\$19.26
	PRICE																																											
1-24	\$34.71																																											
25-49	\$32.28																																											
50-99	\$29.85																																											
100 +	\$27.77																																											
PRICE																																												
1-24	\$57.81																																											
25-49	\$53.76																																											
50-99	\$49.72																																											
100 +	\$46.25																																											
PRICE																																												
1-24	\$46.21																																											
25-49	\$42.98																																											
50-99	\$39.74																																											
100 +	\$36.97																																											
PRICE																																												
1-24	\$24.07																																											
25-49	\$22.39																																											
50-99	\$20.70																																											
100 +	\$19.26																																											
6	 <table border="1"> <thead> <tr> <th colspan="2">PRICE</th> </tr> </thead> <tbody> <tr> <td>1-24</td> <td>\$57.81</td> </tr> <tr> <td>25-49</td> <td>\$53.76</td> </tr> <tr> <td>50-99</td> <td>\$49.72</td> </tr> <tr> <td>100 +</td> <td>\$46.25</td> </tr> </tbody> </table> <p>Model No: <b>PE9481</b></p> <p>N "T" Male-Female-Female</p>	PRICE		1-24	\$57.81	25-49	\$53.76	50-99	\$49.72	100 +	\$46.25	 <table border="1"> <thead> <tr> <th colspan="2">PRICE</th> </tr> </thead> <tbody> <tr> <td>1-24</td> <td>\$21.66</td> </tr> <tr> <td>25-49</td> <td>\$20.14</td> </tr> <tr> <td>50-99</td> <td>\$18.63</td> </tr> <tr> <td>100 +</td> <td>\$17.33</td> </tr> </tbody> </table> <p>Model No: <b>PE9101</b></p> <p>N "T" Female-Female-Female</p>	PRICE		1-24	\$21.66	25-49	\$20.14	50-99	\$18.63	100 +	\$17.33	 <table border="1"> <thead> <tr> <th colspan="2">PRICE</th> </tr> </thead> <tbody> <tr> <td>1-24</td> <td>\$58.87</td> </tr> <tr> <td>25-49</td> <td>\$54.75</td> </tr> <tr> <td>50-99</td> <td>\$50.63</td> </tr> <tr> <td>100 +</td> <td>\$47.10</td> </tr> </tbody> </table> <p>Model No: <b>PE9549</b></p> <p>N Cross Female-Female-Female-Male</p>	PRICE		1-24	\$58.87	25-49	\$54.75	50-99	\$50.63	100 +	\$47.10	 <table border="1"> <thead> <tr> <th colspan="2">PRICE</th> </tr> </thead> <tbody> <tr> <td>1-24</td> <td>\$58.87</td> </tr> <tr> <td>25-49</td> <td>\$54.75</td> </tr> <tr> <td>50-99</td> <td>\$50.63</td> </tr> <tr> <td>100 +</td> <td>\$47.10</td> </tr> </tbody> </table> <p>Model No: <b>PE9548</b></p> <p>N Cross Female-Female-Female-Female</p>	PRICE		1-24	\$58.87	25-49	\$54.75	50-99	\$50.63	100 +	\$47.10
	PRICE																																											
1-24	\$57.81																																											
25-49	\$53.76																																											
50-99	\$49.72																																											
100 +	\$46.25																																											
PRICE																																												
1-24	\$21.66																																											
25-49	\$20.14																																											
50-99	\$18.63																																											
100 +	\$17.33																																											
PRICE																																												
1-24	\$58.87																																											
25-49	\$54.75																																											
50-99	\$50.63																																											
100 +	\$47.10																																											
PRICE																																												
1-24	\$58.87																																											
25-49	\$54.75																																											
50-99	\$50.63																																											
100 +	\$47.10																																											











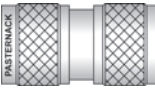
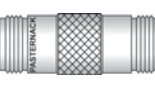
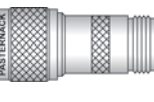
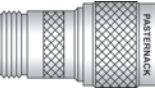

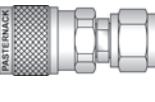
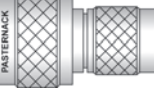
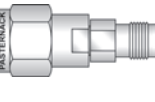
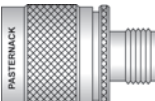
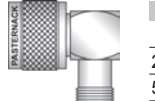
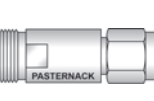
ROHS & REACH COMPLIANT. CUSTOM-LENGTH CABLE ASSEMBLIES MAY BE ORDERED ON OUR WEBSITE.

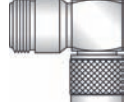
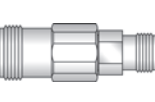
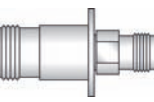

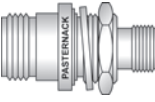
# ADAPTERS

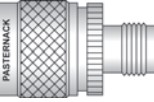
See Adapter Locator on Pages 140-145 or the Adapter Matrix on Pages 138-139

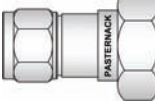
See Page 246 for Mounting Holes

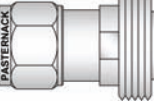
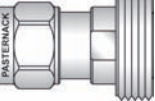
	A	B	C	D																																								
1	 <table border="1"> <thead> <tr> <th colspan="2">PRICE</th> </tr> </thead> <tbody> <tr> <td>1-24</td> <td>\$27.06</td> </tr> <tr> <td>25-49</td> <td>\$25.17</td> </tr> <tr> <td>50-99</td> <td>\$23.27</td> </tr> <tr> <td>100 +</td> <td>\$21.65</td> </tr> </tbody> </table> <p><b>Model No: PE9772</b> Reverse Polarity N Male To Reverse Polarity N Male</p>	PRICE		1-24	\$27.06	25-49	\$25.17	50-99	\$23.27	100 +	\$21.65	 <table border="1"> <thead> <tr> <th colspan="2">PRICE</th> </tr> </thead> <tbody> <tr> <td>1-24</td> <td>\$23.51</td> </tr> <tr> <td>25-49</td> <td>\$21.86</td> </tr> <tr> <td>50-99</td> <td>\$20.22</td> </tr> <tr> <td>100 +</td> <td>\$18.81</td> </tr> </tbody> </table> <p><b>Model No: PE9773</b> Reverse Polarity N Female To Reverse Polarity N Female</p>	PRICE		1-24	\$23.51	25-49	\$21.86	50-99	\$20.22	100 +	\$18.81	 <table border="1"> <thead> <tr> <th colspan="2">PRICE</th> </tr> </thead> <tbody> <tr> <td>1-24</td> <td>\$23.51</td> </tr> <tr> <td>25-49</td> <td>\$21.86</td> </tr> <tr> <td>50-99</td> <td>\$20.22</td> </tr> <tr> <td>100 +</td> <td>\$18.81</td> </tr> </tbody> </table> <p><b>Model No: PE9771</b> N Male To Reverse Polarity N Female</p>	PRICE		1-24	\$23.51	25-49	\$21.86	50-99	\$20.22	100 +	\$18.81	 <table border="1"> <thead> <tr> <th colspan="2">PRICE</th> </tr> </thead> <tbody> <tr> <td>1-24</td> <td>\$23.15</td> </tr> <tr> <td>25-49</td> <td>\$21.53</td> </tr> <tr> <td>50-99</td> <td>\$19.91</td> </tr> <tr> <td>100 +</td> <td>\$18.52</td> </tr> </tbody> </table> <p><b>Model No: PE9770</b> N Female To Reverse Polarity N Male</p>	PRICE		1-24	\$23.15	25-49	\$21.53	50-99	\$19.91	100 +	\$18.52
	PRICE																																											
1-24	\$27.06																																											
25-49	\$25.17																																											
50-99	\$23.27																																											
100 +	\$21.65																																											
PRICE																																												
1-24	\$23.51																																											
25-49	\$21.86																																											
50-99	\$20.22																																											
100 +	\$18.81																																											
PRICE																																												
1-24	\$23.51																																											
25-49	\$21.86																																											
50-99	\$20.22																																											
100 +	\$18.81																																											
PRICE																																												
1-24	\$23.15																																											
25-49	\$21.53																																											
50-99	\$19.91																																											
100 +	\$18.52																																											
2	<div style="background-color: black; color: white; padding: 10px; text-align: center;"> <h2 style="margin: 0;">N Between-Series</h2>  </div>																																											
	 <table border="1"> <thead> <tr> <th colspan="2">PRICE</th> </tr> </thead> <tbody> <tr> <td>1-24</td> <td>\$107.78</td> </tr> <tr> <td>25-49</td> <td>\$100.24</td> </tr> <tr> <td>50-99</td> <td>\$92.69</td> </tr> <tr> <td>100 +</td> <td>\$86.22</td> </tr> </tbody> </table> <p><b>PRECISION</b> <b>Model No: PE9446</b> N Male To TNC Male Max VSWR 1.15:1 @ 18 GHz</p>	PRICE		1-24	\$107.78	25-49	\$100.24	50-99	\$92.69	100 +	\$86.22	 <table border="1"> <thead> <tr> <th colspan="2">PRICE</th> </tr> </thead> <tbody> <tr> <td>1-24</td> <td>\$32.15</td> </tr> <tr> <td>25-49</td> <td>\$29.90</td> </tr> <tr> <td>50-99</td> <td>\$27.65</td> </tr> <tr> <td>100 +</td> <td>\$25.72</td> </tr> </tbody> </table> <p><b>Model No: PE9130</b> N Male To TNC Male</p>	PRICE		1-24	\$32.15	25-49	\$29.90	50-99	\$27.65	100 +	\$25.72	 <table border="1"> <thead> <tr> <th colspan="2">PRICE</th> </tr> </thead> <tbody> <tr> <td>1-24</td> <td>\$104.12</td> </tr> <tr> <td>25-49</td> <td>\$96.83</td> </tr> <tr> <td>50-99</td> <td>\$89.54</td> </tr> <tr> <td>100 +</td> <td>\$83.30</td> </tr> </tbody> </table> <p><b>PRECISION</b> <b>Model No: PE9448</b> N Male To TNC Female Max VSWR 1.15:1 @ 18 GHz</p>	PRICE		1-24	\$104.12	25-49	\$96.83	50-99	\$89.54	100 +	\$83.30											
PRICE																																												
1-24	\$107.78																																											
25-49	\$100.24																																											
50-99	\$92.69																																											
100 +	\$86.22																																											
PRICE																																												
1-24	\$32.15																																											
25-49	\$29.90																																											
50-99	\$27.65																																											
100 +	\$25.72																																											
PRICE																																												
1-24	\$104.12																																											
25-49	\$96.83																																											
50-99	\$89.54																																											
100 +	\$83.30																																											
3	 <table border="1"> <thead> <tr> <th colspan="2">PRICE</th> </tr> </thead> <tbody> <tr> <td>1-24</td> <td>\$20.88</td> </tr> <tr> <td>25-49</td> <td>\$19.42</td> </tr> <tr> <td>50-99</td> <td>\$17.96</td> </tr> <tr> <td>100 +</td> <td>\$16.70</td> </tr> </tbody> </table> <p><b>Model No: PE9090</b> N Male To TNC Female</p>	PRICE		1-24	\$20.88	25-49	\$19.42	50-99	\$17.96	100 +	\$16.70	 <table border="1"> <thead> <tr> <th colspan="2">PRICE</th> </tr> </thead> <tbody> <tr> <td>1-24</td> <td>\$57.81</td> </tr> <tr> <td>25-49</td> <td>\$53.76</td> </tr> <tr> <td>50-99</td> <td>\$49.72</td> </tr> <tr> <td>100 +</td> <td>\$46.25</td> </tr> </tbody> </table> <p><b>Model No: PE9550</b> N Male To TNC Female Right Angle</p>	PRICE		1-24	\$57.81	25-49	\$53.76	50-99	\$49.72	100 +	\$46.25	 <table border="1"> <thead> <tr> <th colspan="2">PRICE</th> </tr> </thead> <tbody> <tr> <td>1-24</td> <td>\$104.12</td> </tr> <tr> <td>25-49</td> <td>\$96.83</td> </tr> <tr> <td>50-99</td> <td>\$89.54</td> </tr> <tr> <td>100 +</td> <td>\$83.30</td> </tr> </tbody> </table> <p><b>PRECISION</b> <b>Model No: PE9447</b> N Female To TNC Male Max VSWR 1.15:1 @ 18 GHz</p>	PRICE		1-24	\$104.12	25-49	\$96.83	50-99	\$89.54	100 +	\$83.30	 <table border="1"> <thead> <tr> <th colspan="2">PRICE</th> </tr> </thead> <tbody> <tr> <td>1-24</td> <td>\$21.82</td> </tr> <tr> <td>25-49</td> <td>\$20.29</td> </tr> <tr> <td>50-99</td> <td>\$18.77</td> </tr> <tr> <td>100 +</td> <td>\$17.46</td> </tr> </tbody> </table> <p><b>Model No: PE9089</b> N Female To TNC Male</p>	PRICE		1-24	\$21.82	25-49	\$20.29	50-99	\$18.77	100 +	\$17.46
	PRICE																																											
1-24	\$20.88																																											
25-49	\$19.42																																											
50-99	\$17.96																																											
100 +	\$16.70																																											
PRICE																																												
1-24	\$57.81																																											
25-49	\$53.76																																											
50-99	\$49.72																																											
100 +	\$46.25																																											
PRICE																																												
1-24	\$104.12																																											
25-49	\$96.83																																											
50-99	\$89.54																																											
100 +	\$83.30																																											
PRICE																																												
1-24	\$21.82																																											
25-49	\$20.29																																											
50-99	\$18.77																																											
100 +	\$17.46																																											
4	 <table border="1"> <thead> <tr> <th colspan="2">PRICE</th> </tr> </thead> <tbody> <tr> <td>1-24</td> <td>\$47.42</td> </tr> <tr> <td>25-49</td> <td>\$44.10</td> </tr> <tr> <td>50-99</td> <td>\$40.78</td> </tr> <tr> <td>100 +</td> <td>\$37.94</td> </tr> </tbody> </table> <p><b>Model No: PE9263</b> N Female To TNC Male Right Angle</p>	PRICE		1-24	\$47.42	25-49	\$44.10	50-99	\$40.78	100 +	\$37.94	 <table border="1"> <thead> <tr> <th colspan="2">PRICE</th> </tr> </thead> <tbody> <tr> <td>1-24</td> <td>\$110.04</td> </tr> <tr> <td>25-49</td> <td>\$102.34</td> </tr> <tr> <td>50-99</td> <td>\$94.63</td> </tr> <tr> <td>100 +</td> <td>\$88.03</td> </tr> </tbody> </table> <p><b>PRECISION</b> <b>Model No: PE9449</b> N Female To TNC Female Max VSWR 1.15:1 @ 18 GHz</p>	PRICE		1-24	\$110.04	25-49	\$102.34	50-99	\$94.63	100 +	\$88.03	 <table border="1"> <thead> <tr> <th colspan="2">PRICE</th> </tr> </thead> <tbody> <tr> <td>1-24</td> <td>\$104.12</td> </tr> <tr> <td>25-49</td> <td>\$96.83</td> </tr> <tr> <td>50-99</td> <td>\$89.54</td> </tr> <tr> <td>100 +</td> <td>\$83.30</td> </tr> </tbody> </table> <p><b>PRECISION</b> <b>Model No: PE9450</b> N Female To TNC Female Panel Mount Max VSWR 1.15:1 @ 18 GHz Mounting Hole A05</p>	PRICE		1-24	\$104.12	25-49	\$96.83	50-99	\$89.54	100 +	\$83.30	 <table border="1"> <thead> <tr> <th colspan="2">PRICE</th> </tr> </thead> <tbody> <tr> <td>1-24</td> <td>\$34.62</td> </tr> <tr> <td>25-49</td> <td>\$32.20</td> </tr> <tr> <td>50-99</td> <td>\$29.77</td> </tr> <tr> <td>100 +</td> <td>\$27.70</td> </tr> </tbody> </table> <p><b>Model No: PE9131</b> N Female To TNC Female</p>	PRICE		1-24	\$34.62	25-49	\$32.20	50-99	\$29.77	100 +	\$27.70
	PRICE																																											
1-24	\$47.42																																											
25-49	\$44.10																																											
50-99	\$40.78																																											
100 +	\$37.94																																											
PRICE																																												
1-24	\$110.04																																											
25-49	\$102.34																																											
50-99	\$94.63																																											
100 +	\$88.03																																											
PRICE																																												
1-24	\$104.12																																											
25-49	\$96.83																																											
50-99	\$89.54																																											
100 +	\$83.30																																											
PRICE																																												
1-24	\$34.62																																											
25-49	\$32.20																																											
50-99	\$29.77																																											
100 +	\$27.70																																											
5	 <table border="1"> <thead> <tr> <th colspan="2">PRICE</th> </tr> </thead> <tbody> <tr> <td>1-24</td> <td>\$33.79</td> </tr> <tr> <td>25-49</td> <td>\$31.42</td> </tr> <tr> <td>50-99</td> <td>\$29.06</td> </tr> <tr> <td>100 +</td> <td>\$27.03</td> </tr> </tbody> </table> <p><b>Model No: PE9482</b> N Female To TNC Female Bulkhead Mounting Hole G01</p>	PRICE		1-24	\$33.79	25-49	\$31.42	50-99	\$29.06	100 +	\$27.03	 <table border="1"> <thead> <tr> <th colspan="2">PRICE</th> </tr> </thead> <tbody> <tr> <td>1-24</td> <td>\$58.87</td> </tr> <tr> <td>25-49</td> <td>\$54.75</td> </tr> <tr> <td>50-99</td> <td>\$50.63</td> </tr> <tr> <td>100 +</td> <td>\$47.10</td> </tr> </tbody> </table> <p><b>Model No: PE9552</b> N Female To TNC Female Panel Mount Mounting Hole A05</p>	PRICE		1-24	\$58.87	25-49	\$54.75	50-99	\$50.63	100 +	\$47.10	 <table border="1"> <thead> <tr> <th colspan="2">PRICE</th> </tr> </thead> <tbody> <tr> <td>1-24</td> <td>\$34.50</td> </tr> <tr> <td>25-49</td> <td>\$32.09</td> </tr> <tr> <td>50-99</td> <td>\$29.67</td> </tr> <tr> <td>100 +</td> <td>\$27.60</td> </tr> </tbody> </table> <p><b>Model No: PE9730</b> N Male To Reverse Polarity TNC Female</p>	PRICE		1-24	\$34.50	25-49	\$32.09	50-99	\$29.67	100 +	\$27.60	 <table border="1"> <thead> <tr> <th colspan="2">PRICE</th> </tr> </thead> <tbody> <tr> <td>1-24</td> <td>\$31.72</td> </tr> <tr> <td>25-49</td> <td>\$29.50</td> </tr> <tr> <td>50-99</td> <td>\$27.28</td> </tr> <tr> <td>100 +</td> <td>\$25.38</td> </tr> </tbody> </table> <p><b>Model No: PE9731</b> N Female To Reverse Polarity TNC Male</p>	PRICE		1-24	\$31.72	25-49	\$29.50	50-99	\$27.28	100 +	\$25.38
	PRICE																																											
1-24	\$33.79																																											
25-49	\$31.42																																											
50-99	\$29.06																																											
100 +	\$27.03																																											
PRICE																																												
1-24	\$58.87																																											
25-49	\$54.75																																											
50-99	\$50.63																																											
100 +	\$47.10																																											
PRICE																																												
1-24	\$34.50																																											
25-49	\$32.09																																											
50-99	\$29.67																																											
100 +	\$27.60																																											
PRICE																																												
1-24	\$31.72																																											
25-49	\$29.50																																											
50-99	\$27.28																																											
100 +	\$25.38																																											
6	 <table border="1"> <thead> <tr> <th colspan="2">PRICE</th> </tr> </thead> <tbody> <tr> <td>1-24</td> <td>\$65.00</td> </tr> <tr> <td>25-49</td> <td>\$60.45</td> </tr> <tr> <td>50-99</td> <td>\$55.90</td> </tr> <tr> <td>100 +</td> <td>\$52.00</td> </tr> </tbody> </table> <p><b>PRECISION NEW</b> <b>Model No: PE91030</b> N Male To 7/16 Male Low PIM, Low VSWR</p>	PRICE		1-24	\$65.00	25-49	\$60.45	50-99	\$55.90	100 +	\$52.00	 <table border="1"> <thead> <tr> <th colspan="2">PRICE</th> </tr> </thead> <tbody> <tr> <td>1-24</td> <td>\$140.29</td> </tr> <tr> <td>25-49</td> <td>\$130.47</td> </tr> <tr> <td>50-99</td> <td>\$120.65</td> </tr> <tr> <td>100 +</td> <td>\$112.23</td> </tr> </tbody> </table> <p><b>Model No: PE9535</b> N Male To 7/16 Male</p>	PRICE		1-24	\$140.29	25-49	\$130.47	50-99	\$120.65	100 +	\$112.23	 <table border="1"> <thead> <tr> <th colspan="2">PRICE</th> </tr> </thead> <tbody> <tr> <td>1-24</td> <td>\$65.00</td> </tr> <tr> <td>25-49</td> <td>\$60.45</td> </tr> <tr> <td>50-99</td> <td>\$55.90</td> </tr> <tr> <td>100 +</td> <td>\$52.00</td> </tr> </tbody> </table> <p><b>PRECISION NEW</b> <b>Model No: PE91032</b> N Male To 7/16 Female Low PIM, Low VSWR</p>	PRICE		1-24	\$65.00	25-49	\$60.45	50-99	\$55.90	100 +	\$52.00	 <table border="1"> <thead> <tr> <th colspan="2">PRICE</th> </tr> </thead> <tbody> <tr> <td>1-24</td> <td>\$82.99</td> </tr> <tr> <td>25-49</td> <td>\$77.18</td> </tr> <tr> <td>50-99</td> <td>\$71.37</td> </tr> <tr> <td>100 +</td> <td>\$66.39</td> </tr> </tbody> </table> <p><b>Model No: PE9178</b> N Male To 7/16 Female</p>	PRICE		1-24	\$82.99	25-49	\$77.18	50-99	\$71.37	100 +	\$66.39
	PRICE																																											
1-24	\$65.00																																											
25-49	\$60.45																																											
50-99	\$55.90																																											
100 +	\$52.00																																											
PRICE																																												
1-24	\$140.29																																											
25-49	\$130.47																																											
50-99	\$120.65																																											
100 +	\$112.23																																											
PRICE																																												
1-24	\$65.00																																											
25-49	\$60.45																																											
50-99	\$55.90																																											
100 +	\$52.00																																											
PRICE																																												
1-24	\$82.99																																											
25-49	\$77.18																																											
50-99	\$71.37																																											
100 +	\$66.39																																											

Adapters

See Our Website For Real-Time Stock Availability!













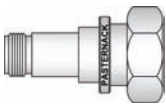
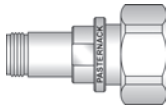
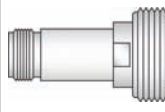

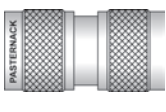
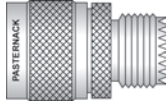
# ADAPTERS

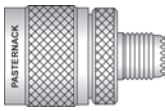
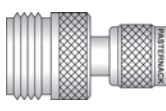
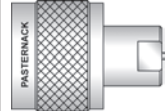
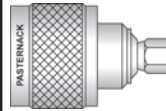
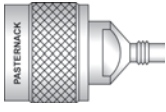
See Adapter Locator on Pages 140-145 or the Adapter Matrix on Pages 138-139

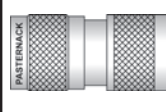
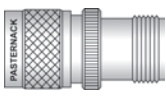
See Page 246 for Mounting Holes

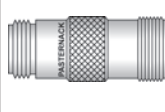
Adapters

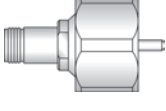
See Our Website For Real-Time Stock Availability!

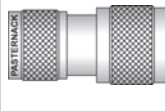
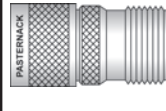









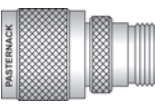

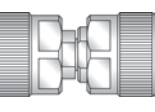

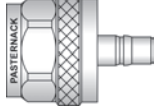
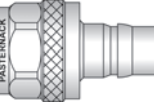

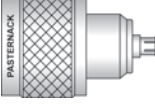

	A	B	C	D																																								
1	 <table border="1"> <thead> <tr> <th colspan="2">PRICE</th> </tr> </thead> <tbody> <tr> <td>1-24</td> <td>\$75.00</td> </tr> <tr> <td>25-49</td> <td>\$69.75</td> </tr> <tr> <td>50-99</td> <td>\$64.50</td> </tr> <tr> <td>100 +</td> <td>\$60.00</td> </tr> </tbody> </table> <p><b>PRECISION NEW</b> Model No: <b>PE91031</b> N Female To 7/16 Male Low PIM, Low VSWR</p>	PRICE		1-24	\$75.00	25-49	\$69.75	50-99	\$64.50	100 +	\$60.00	 <table border="1"> <thead> <tr> <th colspan="2">PRICE</th> </tr> </thead> <tbody> <tr> <td>1-24</td> <td>\$104.52</td> </tr> <tr> <td>25-49</td> <td>\$97.20</td> </tr> <tr> <td>50-99</td> <td>\$89.89</td> </tr> <tr> <td>100 +</td> <td>\$83.62</td> </tr> </tbody> </table> <p>Model No: <b>PE9179</b> N Female To 7/16 Male</p>	PRICE		1-24	\$104.52	25-49	\$97.20	50-99	\$89.89	100 +	\$83.62	 <table border="1"> <thead> <tr> <th colspan="2">PRICE</th> </tr> </thead> <tbody> <tr> <td>1-24</td> <td>\$65.00</td> </tr> <tr> <td>25-49</td> <td>\$60.45</td> </tr> <tr> <td>50-99</td> <td>\$55.90</td> </tr> <tr> <td>100 +</td> <td>\$52.00</td> </tr> </tbody> </table> <p><b>PRECISION NEW</b> Model No: <b>PE91033</b> N Female To 7/16 Female Low PIM, Low VSWR</p>	PRICE		1-24	\$65.00	25-49	\$60.45	50-99	\$55.90	100 +	\$52.00	 <table border="1"> <thead> <tr> <th colspan="2">PRICE</th> </tr> </thead> <tbody> <tr> <td>1-24</td> <td>\$98.34</td> </tr> <tr> <td>25-49</td> <td>\$91.46</td> </tr> <tr> <td>50-99</td> <td>\$84.57</td> </tr> <tr> <td>100 +</td> <td>\$78.67</td> </tr> </tbody> </table> <p>Model No: <b>PE9180</b> N Female To 7/16 Female</p>	PRICE		1-24	\$98.34	25-49	\$91.46	50-99	\$84.57	100 +	\$78.67
PRICE																																												
1-24	\$75.00																																											
25-49	\$69.75																																											
50-99	\$64.50																																											
100 +	\$60.00																																											
PRICE																																												
1-24	\$104.52																																											
25-49	\$97.20																																											
50-99	\$89.89																																											
100 +	\$83.62																																											
PRICE																																												
1-24	\$65.00																																											
25-49	\$60.45																																											
50-99	\$55.90																																											
100 +	\$52.00																																											
PRICE																																												
1-24	\$98.34																																											
25-49	\$91.46																																											
50-99	\$84.57																																											
100 +	\$78.67																																											
2	 <table border="1"> <thead> <tr> <th colspan="2">PRICE</th> </tr> </thead> <tbody> <tr> <td>1-24</td> <td>\$22.95</td> </tr> <tr> <td>25-49</td> <td>\$21.34</td> </tr> <tr> <td>50-99</td> <td>\$19.74</td> </tr> <tr> <td>100 +</td> <td>\$18.36</td> </tr> </tbody> </table> <p>Model No: <b>PE9113</b> N Male To UHF Male</p>	PRICE		1-24	\$22.95	25-49	\$21.34	50-99	\$19.74	100 +	\$18.36	 <table border="1"> <thead> <tr> <th colspan="2">PRICE</th> </tr> </thead> <tbody> <tr> <td>1-24</td> <td>\$21.66</td> </tr> <tr> <td>25-49</td> <td>\$20.14</td> </tr> <tr> <td>50-99</td> <td>\$18.63</td> </tr> <tr> <td>100 +</td> <td>\$17.33</td> </tr> </tbody> </table> <p>Model No: <b>PE9111</b> N Male To UHF Female</p>	PRICE		1-24	\$21.66	25-49	\$20.14	50-99	\$18.63	100 +	\$17.33	 <table border="1"> <thead> <tr> <th colspan="2">PRICE</th> </tr> </thead> <tbody> <tr> <td>1-24</td> <td>\$18.62</td> </tr> <tr> <td>25-49</td> <td>\$17.32</td> </tr> <tr> <td>50-99</td> <td>\$16.01</td> </tr> <tr> <td>100 +</td> <td>\$14.90</td> </tr> </tbody> </table> <p>Model No: <b>PE9112</b> N Female To UHF Male</p>	PRICE		1-24	\$18.62	25-49	\$17.32	50-99	\$16.01	100 +	\$14.90	 <table border="1"> <thead> <tr> <th colspan="2">PRICE</th> </tr> </thead> <tbody> <tr> <td>1-24</td> <td>\$16.87</td> </tr> <tr> <td>25-49</td> <td>\$15.69</td> </tr> <tr> <td>50-99</td> <td>\$14.51</td> </tr> <tr> <td>100 +</td> <td>\$13.50</td> </tr> </tbody> </table> <p>Model No: <b>PE9385</b> N Female To UHF Female</p>	PRICE		1-24	\$16.87	25-49	\$15.69	50-99	\$14.51	100 +	\$13.50
PRICE																																												
1-24	\$22.95																																											
25-49	\$21.34																																											
50-99	\$19.74																																											
100 +	\$18.36																																											
PRICE																																												
1-24	\$21.66																																											
25-49	\$20.14																																											
50-99	\$18.63																																											
100 +	\$17.33																																											
PRICE																																												
1-24	\$18.62																																											
25-49	\$17.32																																											
50-99	\$16.01																																											
100 +	\$14.90																																											
PRICE																																												
1-24	\$16.87																																											
25-49	\$15.69																																											
50-99	\$14.51																																											
100 +	\$13.50																																											
3	 <table border="1"> <thead> <tr> <th colspan="2">PRICE</th> </tr> </thead> <tbody> <tr> <td>1-24</td> <td>\$13.22</td> </tr> <tr> <td>25-49</td> <td>\$12.29</td> </tr> <tr> <td>50-99</td> <td>\$11.37</td> </tr> <tr> <td>100 +</td> <td>\$10.58</td> </tr> </tbody> </table> <p>Model No: <b>PE9064</b> N Male To Mini UHF Female</p>	PRICE		1-24	\$13.22	25-49	\$12.29	50-99	\$11.37	100 +	\$10.58	 <table border="1"> <thead> <tr> <th colspan="2">PRICE</th> </tr> </thead> <tbody> <tr> <td>1-24</td> <td>\$15.66</td> </tr> <tr> <td>25-49</td> <td>\$14.56</td> </tr> <tr> <td>50-99</td> <td>\$13.47</td> </tr> <tr> <td>100 +</td> <td>\$12.53</td> </tr> </tbody> </table> <p>Model No: <b>PE9183</b> N Female To Mini UHF Male</p>	PRICE		1-24	\$15.66	25-49	\$14.56	50-99	\$13.47	100 +	\$12.53	 <table border="1"> <thead> <tr> <th colspan="2">PRICE</th> </tr> </thead> <tbody> <tr> <td>1-24</td> <td>\$11.70</td> </tr> <tr> <td>25-49</td> <td>\$10.88</td> </tr> <tr> <td>50-99</td> <td>\$10.06</td> </tr> <tr> <td>100 +</td> <td>\$9.36</td> </tr> </tbody> </table> <p>Model No: <b>PE9704</b> N Male To FME Plug</p>	PRICE		1-24	\$11.70	25-49	\$10.88	50-99	\$10.06	100 +	\$9.36	 <table border="1"> <thead> <tr> <th colspan="2">PRICE</th> </tr> </thead> <tbody> <tr> <td>1-24</td> <td>\$63.13</td> </tr> <tr> <td>25-49</td> <td>\$58.71</td> </tr> <tr> <td>50-99</td> <td>\$54.29</td> </tr> <tr> <td>100 +</td> <td>\$50.50</td> </tr> </tbody> </table> <p>Model No: <b>PE9318</b> N Male To SMC Plug</p>	PRICE		1-24	\$63.13	25-49	\$58.71	50-99	\$54.29	100 +	\$50.50
PRICE																																												
1-24	\$13.22																																											
25-49	\$12.29																																											
50-99	\$11.37																																											
100 +	\$10.58																																											
PRICE																																												
1-24	\$15.66																																											
25-49	\$14.56																																											
50-99	\$13.47																																											
100 +	\$12.53																																											
PRICE																																												
1-24	\$11.70																																											
25-49	\$10.88																																											
50-99	\$10.06																																											
100 +	\$9.36																																											
PRICE																																												
1-24	\$63.13																																											
25-49	\$58.71																																											
50-99	\$54.29																																											
100 +	\$50.50																																											
4	 <table border="1"> <thead> <tr> <th colspan="2">PRICE</th> </tr> </thead> <tbody> <tr> <td>1-24</td> <td>\$58.87</td> </tr> <tr> <td>25-49</td> <td>\$54.75</td> </tr> <tr> <td>50-99</td> <td>\$50.63</td> </tr> <tr> <td>100 +</td> <td>\$47.10</td> </tr> </tbody> </table> <p>Model No: <b>PE9317</b> N Male To SMC Jack</p>	PRICE		1-24	\$58.87	25-49	\$54.75	50-99	\$50.63	100 +	\$47.10	 <table border="1"> <thead> <tr> <th colspan="2">PRICE</th> </tr> </thead> <tbody> <tr> <td>1-24</td> <td>\$58.87</td> </tr> <tr> <td>25-49</td> <td>\$54.75</td> </tr> <tr> <td>50-99</td> <td>\$50.63</td> </tr> <tr> <td>100 +</td> <td>\$47.10</td> </tr> </tbody> </table> <p>Model No: <b>PE9320</b> N Female To SMC Plug</p>	PRICE		1-24	\$58.87	25-49	\$54.75	50-99	\$50.63	100 +	\$47.10	 <table border="1"> <thead> <tr> <th colspan="2">PRICE</th> </tr> </thead> <tbody> <tr> <td>1-24</td> <td>\$58.87</td> </tr> <tr> <td>25-49</td> <td>\$54.75</td> </tr> <tr> <td>50-99</td> <td>\$50.63</td> </tr> <tr> <td>100 +</td> <td>\$47.10</td> </tr> </tbody> </table> <p>Model No: <b>PE9319</b> N Female To SMC Jack</p>	PRICE		1-24	\$58.87	25-49	\$54.75	50-99	\$50.63	100 +	\$47.10	 <table border="1"> <thead> <tr> <th colspan="2">PRICE</th> </tr> </thead> <tbody> <tr> <td>1-24</td> <td>\$83.70</td> </tr> <tr> <td>25-49</td> <td>\$77.84</td> </tr> <tr> <td>50-99</td> <td>\$71.98</td> </tr> <tr> <td>100 +</td> <td>\$66.96</td> </tr> </tbody> </table> <p>Model No: <b>PE9570</b> N Male To SC Male</p>	PRICE		1-24	\$83.70	25-49	\$77.84	50-99	\$71.98	100 +	\$66.96
PRICE																																												
1-24	\$58.87																																											
25-49	\$54.75																																											
50-99	\$50.63																																											
100 +	\$47.10																																											
PRICE																																												
1-24	\$58.87																																											
25-49	\$54.75																																											
50-99	\$50.63																																											
100 +	\$47.10																																											
PRICE																																												
1-24	\$58.87																																											
25-49	\$54.75																																											
50-99	\$50.63																																											
100 +	\$47.10																																											
PRICE																																												
1-24	\$83.70																																											
25-49	\$77.84																																											
50-99	\$71.98																																											
100 +	\$66.96																																											
5	 <table border="1"> <thead> <tr> <th colspan="2">PRICE</th> </tr> </thead> <tbody> <tr> <td>1-24</td> <td>\$83.82</td> </tr> <tr> <td>25-49</td> <td>\$77.95</td> </tr> <tr> <td>50-99</td> <td>\$72.09</td> </tr> <tr> <td>100 +</td> <td>\$67.06</td> </tr> </tbody> </table> <p>Model No: <b>PE9196</b> N Male To SC Female</p>	PRICE		1-24	\$83.82	25-49	\$77.95	50-99	\$72.09	100 +	\$67.06	 <table border="1"> <thead> <tr> <th colspan="2">PRICE</th> </tr> </thead> <tbody> <tr> <td>1-24</td> <td>\$84.56</td> </tr> <tr> <td>25-49</td> <td>\$78.64</td> </tr> <tr> <td>50-99</td> <td>\$72.72</td> </tr> <tr> <td>100 +</td> <td>\$67.65</td> </tr> </tbody> </table> <p>Model No: <b>PE9277</b> N Female To SC Male</p>	PRICE		1-24	\$84.56	25-49	\$78.64	50-99	\$72.72	100 +	\$67.65	 <table border="1"> <thead> <tr> <th colspan="2">PRICE</th> </tr> </thead> <tbody> <tr> <td>1-24</td> <td>\$80.96</td> </tr> <tr> <td>25-49</td> <td>\$75.29</td> </tr> <tr> <td>50-99</td> <td>\$69.63</td> </tr> <tr> <td>100 +</td> <td>\$64.77</td> </tr> </tbody> </table> <p>Model No: <b>PE9292</b> N Female To SC Female</p>	PRICE		1-24	\$80.96	25-49	\$75.29	50-99	\$69.63	100 +	\$64.77	 <table border="1"> <thead> <tr> <th colspan="2">PRICE</th> </tr> </thead> <tbody> <tr> <td>1-24</td> <td>\$219.94</td> </tr> <tr> <td>25-49</td> <td>\$204.54</td> </tr> <tr> <td>50-99</td> <td>\$189.15</td> </tr> <tr> <td>100 +</td> <td>\$175.95</td> </tr> </tbody> </table> <p>Model No: <b>PE9299</b> N Male To LC Female</p>	PRICE		1-24	\$219.94	25-49	\$204.54	50-99	\$189.15	100 +	\$175.95
PRICE																																												
1-24	\$83.82																																											
25-49	\$77.95																																											
50-99	\$72.09																																											
100 +	\$67.06																																											
PRICE																																												
1-24	\$84.56																																											
25-49	\$78.64																																											
50-99	\$72.72																																											
100 +	\$67.65																																											
PRICE																																												
1-24	\$80.96																																											
25-49	\$75.29																																											
50-99	\$69.63																																											
100 +	\$64.77																																											
PRICE																																												
1-24	\$219.94																																											
25-49	\$204.54																																											
50-99	\$189.15																																											
100 +	\$175.95																																											
6	 <table border="1"> <thead> <tr> <th colspan="2">PRICE</th> </tr> </thead> <tbody> <tr> <td>1-24</td> <td>\$177.68</td> </tr> <tr> <td>25-49</td> <td>\$165.24</td> </tr> <tr> <td>50-99</td> <td>\$152.80</td> </tr> <tr> <td>100 +</td> <td>\$142.14</td> </tr> </tbody> </table> <p>Model No: <b>PE9237</b> N Female To LC Male</p>	PRICE		1-24	\$177.68	25-49	\$165.24	50-99	\$152.80	100 +	\$142.14	 <table border="1"> <thead> <tr> <th colspan="2">PRICE</th> </tr> </thead> <tbody> <tr> <td>1-24</td> <td>\$184.93</td> </tr> <tr> <td>25-49</td> <td>\$171.98</td> </tr> <tr> <td>50-99</td> <td>\$159.04</td> </tr> <tr> <td>100 +</td> <td>\$147.94</td> </tr> </tbody> </table> <p>Model No: <b>PE9298</b> N Female To LC Female</p>	PRICE		1-24	\$184.93	25-49	\$171.98	50-99	\$159.04	100 +	\$147.94	 <table border="1"> <thead> <tr> <th colspan="2">PRICE</th> </tr> </thead> <tbody> <tr> <td>1-24</td> <td>\$57.81</td> </tr> <tr> <td>25-49</td> <td>\$53.76</td> </tr> <tr> <td>50-99</td> <td>\$49.72</td> </tr> <tr> <td>100 +</td> <td>\$46.25</td> </tr> </tbody> </table> <p>Model No: <b>PE9554</b> N Male To HN Male</p>	PRICE		1-24	\$57.81	25-49	\$53.76	50-99	\$49.72	100 +	\$46.25	 <table border="1"> <thead> <tr> <th colspan="2">PRICE</th> </tr> </thead> <tbody> <tr> <td>1-24</td> <td>\$38.97</td> </tr> <tr> <td>25-49</td> <td>\$36.24</td> </tr> <tr> <td>50-99</td> <td>\$33.51</td> </tr> <tr> <td>100 +</td> <td>\$31.18</td> </tr> </tbody> </table> <p>Model No: <b>PE9125</b> N Male To HN Female</p>	PRICE		1-24	\$38.97	25-49	\$36.24	50-99	\$33.51	100 +	\$31.18
PRICE																																												
1-24	\$177.68																																											
25-49	\$165.24																																											
50-99	\$152.80																																											
100 +	\$142.14																																											
PRICE																																												
1-24	\$184.93																																											
25-49	\$171.98																																											
50-99	\$159.04																																											
100 +	\$147.94																																											
PRICE																																												
1-24	\$57.81																																											
25-49	\$53.76																																											
50-99	\$49.72																																											
100 +	\$46.25																																											
PRICE																																												
1-24	\$38.97																																											
25-49	\$36.24																																											
50-99	\$33.51																																											
100 +	\$31.18																																											

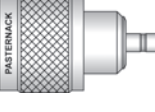
ROHS & REACH COMPLIANT. CUSTOM-LENGTH CABLE ASSEMBLIES MAY BE ORDERED ON OUR WEBSITE.

# ADAPTERS

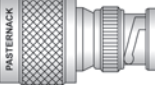
See Adapter Locator on Pages 140-145 or the Adapter Matrix on Pages 138-139

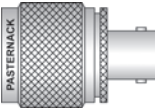
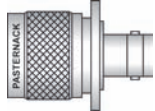
See Page 246 for Mounting Holes

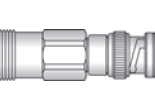
	A	B	C	D																																								
1	 <table border="1"> <thead> <tr> <th colspan="2">PRICE</th> </tr> </thead> <tbody> <tr> <td>1-24</td> <td>\$37.08</td> </tr> <tr> <td>25-49</td> <td>\$34.48</td> </tr> <tr> <td>50-99</td> <td>\$31.89</td> </tr> <tr> <td>100 +</td> <td>\$29.66</td> </tr> </tbody> </table> <p><b>Model No: PE9194</b> N Female To HN Male</p>	PRICE		1-24	\$37.08	25-49	\$34.48	50-99	\$31.89	100 +	\$29.66	 <table border="1"> <thead> <tr> <th colspan="2">PRICE</th> </tr> </thead> <tbody> <tr> <td>1-24</td> <td>\$55.53</td> </tr> <tr> <td>25-49</td> <td>\$51.64</td> </tr> <tr> <td>50-99</td> <td>\$47.76</td> </tr> <tr> <td>100 +</td> <td>\$44.42</td> </tr> </tbody> </table> <p><b>Model No: PE9360</b> N Female To HN Female</p>	PRICE		1-24	\$55.53	25-49	\$51.64	50-99	\$47.76	100 +	\$44.42	 <table border="1"> <thead> <tr> <th colspan="2">PRICE</th> </tr> </thead> <tbody> <tr> <td>1-24</td> <td>\$58.87</td> </tr> <tr> <td>25-49</td> <td>\$54.75</td> </tr> <tr> <td>50-99</td> <td>\$50.63</td> </tr> <tr> <td>100 +</td> <td>\$47.10</td> </tr> </tbody> </table> <p><b>Model No: PE9553</b> N Female To HN Female Panel Mount Mounting Hole A08</p>	PRICE		1-24	\$58.87	25-49	\$54.75	50-99	\$50.63	100 +	\$47.10	 <table border="1"> <thead> <tr> <th colspan="2">PRICE</th> </tr> </thead> <tbody> <tr> <td>1-24</td> <td>\$173.63</td> </tr> <tr> <td>25-49</td> <td>\$161.48</td> </tr> <tr> <td>50-99</td> <td>\$149.32</td> </tr> <tr> <td>100 +</td> <td>\$138.90</td> </tr> </tbody> </table> <p><b>PRECISION</b> <b>Model No: PE9217</b> N Male To 7mm Max VSWR 1.15:1 @ 18 GHz</p>	PRICE		1-24	\$173.63	25-49	\$161.48	50-99	\$149.32	100 +	\$138.90
	PRICE																																											
1-24	\$37.08																																											
25-49	\$34.48																																											
50-99	\$31.89																																											
100 +	\$29.66																																											
PRICE																																												
1-24	\$55.53																																											
25-49	\$51.64																																											
50-99	\$47.76																																											
100 +	\$44.42																																											
PRICE																																												
1-24	\$58.87																																											
25-49	\$54.75																																											
50-99	\$50.63																																											
100 +	\$47.10																																											
PRICE																																												
1-24	\$173.63																																											
25-49	\$161.48																																											
50-99	\$149.32																																											
100 +	\$138.90																																											
2	 <table border="1"> <thead> <tr> <th colspan="2">PRICE</th> </tr> </thead> <tbody> <tr> <td>1-24</td> <td>\$190.04</td> </tr> <tr> <td>25-49</td> <td>\$176.74</td> </tr> <tr> <td>50-99</td> <td>\$163.43</td> </tr> <tr> <td>100 +</td> <td>\$152.03</td> </tr> </tbody> </table> <p><b>PRECISION</b> <b>Model No: PE9216</b> N Female To 7mm Max VSWR 1.15:1 @ 18 GHz</p>	PRICE		1-24	\$190.04	25-49	\$176.74	50-99	\$163.43	100 +	\$152.03	 <table border="1"> <thead> <tr> <th colspan="2">PRICE</th> </tr> </thead> <tbody> <tr> <td>1-24</td> <td>\$101.33</td> </tr> <tr> <td>25-49</td> <td>\$94.24</td> </tr> <tr> <td>50-99</td> <td>\$87.14</td> </tr> <tr> <td>100 +</td> <td>\$81.06</td> </tr> </tbody> </table> <p><b>Model No: PE9787</b> N Male To QMA Female</p>	PRICE		1-24	\$101.33	25-49	\$94.24	50-99	\$87.14	100 +	\$81.06	 <table border="1"> <thead> <tr> <th colspan="2">PRICE</th> </tr> </thead> <tbody> <tr> <td>1-24</td> <td>\$101.33</td> </tr> <tr> <td>25-49</td> <td>\$94.24</td> </tr> <tr> <td>50-99</td> <td>\$87.14</td> </tr> <tr> <td>100 +</td> <td>\$81.06</td> </tr> </tbody> </table> <p><b>Model No: PE9789</b> N Male To QN Female</p>	PRICE		1-24	\$101.33	25-49	\$94.24	50-99	\$87.14	100 +	\$81.06	 <table border="1"> <thead> <tr> <th colspan="2">PRICE</th> </tr> </thead> <tbody> <tr> <td>1-24</td> <td>\$101.28</td> </tr> <tr> <td>25-49</td> <td>\$94.19</td> </tr> <tr> <td>50-99</td> <td>\$87.10</td> </tr> <tr> <td>100 +</td> <td>\$81.02</td> </tr> </tbody> </table> <p><b>Model No: PE9788</b> N Female To QN Male</p>	PRICE		1-24	\$101.28	25-49	\$94.19	50-99	\$87.10	100 +	\$81.02
	PRICE																																											
1-24	\$190.04																																											
25-49	\$176.74																																											
50-99	\$163.43																																											
100 +	\$152.03																																											
PRICE																																												
1-24	\$101.33																																											
25-49	\$94.24																																											
50-99	\$87.14																																											
100 +	\$81.06																																											
PRICE																																												
1-24	\$101.33																																											
25-49	\$94.24																																											
50-99	\$87.14																																											
100 +	\$81.06																																											
PRICE																																												
1-24	\$101.28																																											
25-49	\$94.19																																											
50-99	\$87.10																																											
100 +	\$81.02																																											
3	 <table border="1"> <thead> <tr> <th colspan="2">PRICE</th> </tr> </thead> <tbody> <tr> <td>1-24</td> <td>\$70.68</td> </tr> <tr> <td>25-49</td> <td>\$65.73</td> </tr> <tr> <td>50-99</td> <td>\$60.78</td> </tr> <tr> <td>100 +</td> <td>\$56.54</td> </tr> </tbody> </table> <p><b>Model No: PE9465</b> N Male To MCX Plug</p>	PRICE		1-24	\$70.68	25-49	\$65.73	50-99	\$60.78	100 +	\$56.54	 <table border="1"> <thead> <tr> <th colspan="2">PRICE</th> </tr> </thead> <tbody> <tr> <td>1-24</td> <td>\$70.68</td> </tr> <tr> <td>25-49</td> <td>\$65.73</td> </tr> <tr> <td>50-99</td> <td>\$60.78</td> </tr> <tr> <td>100 +</td> <td>\$56.54</td> </tr> </tbody> </table> <p><b>Model No: PE9464</b> N Male To MCX Jack</p>	PRICE		1-24	\$70.68	25-49	\$65.73	50-99	\$60.78	100 +	\$56.54	 <table border="1"> <thead> <tr> <th colspan="2">PRICE</th> </tr> </thead> <tbody> <tr> <td>1-24</td> <td>\$70.68</td> </tr> <tr> <td>25-49</td> <td>\$65.73</td> </tr> <tr> <td>50-99</td> <td>\$60.78</td> </tr> <tr> <td>100 +</td> <td>\$56.54</td> </tr> </tbody> </table> <p><b>Model No: PE9463</b> N Female To MCX Plug</p>	PRICE		1-24	\$70.68	25-49	\$65.73	50-99	\$60.78	100 +	\$56.54	 <table border="1"> <thead> <tr> <th colspan="2">PRICE</th> </tr> </thead> <tbody> <tr> <td>1-24</td> <td>\$70.68</td> </tr> <tr> <td>25-49</td> <td>\$65.73</td> </tr> <tr> <td>50-99</td> <td>\$60.78</td> </tr> <tr> <td>100 +</td> <td>\$56.54</td> </tr> </tbody> </table> <p><b>Model No: PE9462</b> N Female To MCX Jack</p>	PRICE		1-24	\$70.68	25-49	\$65.73	50-99	\$60.78	100 +	\$56.54
	PRICE																																											
1-24	\$70.68																																											
25-49	\$65.73																																											
50-99	\$60.78																																											
100 +	\$56.54																																											
PRICE																																												
1-24	\$70.68																																											
25-49	\$65.73																																											
50-99	\$60.78																																											
100 +	\$56.54																																											
PRICE																																												
1-24	\$70.68																																											
25-49	\$65.73																																											
50-99	\$60.78																																											
100 +	\$56.54																																											
PRICE																																												
1-24	\$70.68																																											
25-49	\$65.73																																											
50-99	\$60.78																																											
100 +	\$56.54																																											
4	 <table border="1"> <thead> <tr> <th colspan="2">PRICE</th> </tr> </thead> <tbody> <tr> <td>1-24</td> <td>\$48.08</td> </tr> <tr> <td>25-49</td> <td>\$44.71</td> </tr> <tr> <td>50-99</td> <td>\$41.35</td> </tr> <tr> <td>100 +</td> <td>\$38.46</td> </tr> </tbody> </table> <p><b>Model No: PE9314</b> N Male To SMB Plug</p>	PRICE		1-24	\$48.08	25-49	\$44.71	50-99	\$41.35	100 +	\$38.46	 <table border="1"> <thead> <tr> <th colspan="2">PRICE</th> </tr> </thead> <tbody> <tr> <td>1-24</td> <td>\$46.21</td> </tr> <tr> <td>25-49</td> <td>\$42.98</td> </tr> <tr> <td>50-99</td> <td>\$39.74</td> </tr> <tr> <td>100 +</td> <td>\$36.97</td> </tr> </tbody> </table> <p><b>Model No: PE9313</b> N Male To SMB Jack</p>	PRICE		1-24	\$46.21	25-49	\$42.98	50-99	\$39.74	100 +	\$36.97	 <table border="1"> <thead> <tr> <th colspan="2">PRICE</th> </tr> </thead> <tbody> <tr> <td>1-24</td> <td>\$47.12</td> </tr> <tr> <td>25-49</td> <td>\$43.82</td> </tr> <tr> <td>50-99</td> <td>\$40.52</td> </tr> <tr> <td>100 +</td> <td>\$37.70</td> </tr> </tbody> </table> <p><b>Model No: PE9316</b> N Female To SMB Plug</p>	PRICE		1-24	\$47.12	25-49	\$43.82	50-99	\$40.52	100 +	\$37.70	 <table border="1"> <thead> <tr> <th colspan="2">PRICE</th> </tr> </thead> <tbody> <tr> <td>1-24</td> <td>\$47.12</td> </tr> <tr> <td>25-49</td> <td>\$43.82</td> </tr> <tr> <td>50-99</td> <td>\$40.52</td> </tr> <tr> <td>100 +</td> <td>\$37.70</td> </tr> </tbody> </table> <p><b>Model No: PE9315</b> N Female To SMB Jack</p>	PRICE		1-24	\$47.12	25-49	\$43.82	50-99	\$40.52	100 +	\$37.70
	PRICE																																											
1-24	\$48.08																																											
25-49	\$44.71																																											
50-99	\$41.35																																											
100 +	\$38.46																																											
PRICE																																												
1-24	\$46.21																																											
25-49	\$42.98																																											
50-99	\$39.74																																											
100 +	\$36.97																																											
PRICE																																												
1-24	\$47.12																																											
25-49	\$43.82																																											
50-99	\$40.52																																											
100 +	\$37.70																																											
PRICE																																												
1-24	\$47.12																																											
25-49	\$43.82																																											
50-99	\$40.52																																											
100 +	\$37.70																																											
5	 <table border="1"> <thead> <tr> <th colspan="2">PRICE</th> </tr> </thead> <tbody> <tr> <td>1-24</td> <td>\$106.35</td> </tr> <tr> <td>25-49</td> <td>\$98.91</td> </tr> <tr> <td>50-99</td> <td>\$91.46</td> </tr> <tr> <td>100 +</td> <td>\$85.08</td> </tr> </tbody> </table> <p><b>PRECISION</b> <b>Model No: PE9489</b> N Male To BNC Male VSWR 1.20:1 @ 8 GHz</p>	PRICE		1-24	\$106.35	25-49	\$98.91	50-99	\$91.46	100 +	\$85.08	 <table border="1"> <thead> <tr> <th colspan="2">PRICE</th> </tr> </thead> <tbody> <tr> <td>1-24</td> <td>\$31.77</td> </tr> <tr> <td>25-49</td> <td>\$29.55</td> </tr> <tr> <td>50-99</td> <td>\$27.32</td> </tr> <tr> <td>100 +</td> <td>\$25.42</td> </tr> </tbody> </table> <p><b>Model No: PE9127</b> N Male To BNC Male</p>	PRICE		1-24	\$31.77	25-49	\$29.55	50-99	\$27.32	100 +	\$25.42	 <table border="1"> <thead> <tr> <th colspan="2">PRICE</th> </tr> </thead> <tbody> <tr> <td>1-24</td> <td>\$70.68</td> </tr> <tr> <td>25-49</td> <td>\$65.73</td> </tr> <tr> <td>50-99</td> <td>\$60.78</td> </tr> <tr> <td>100 +</td> <td>\$56.54</td> </tr> </tbody> </table> <p><b>Model No: PE9565</b> N Male To BNC Male Right Angle</p>	PRICE		1-24	\$70.68	25-49	\$65.73	50-99	\$60.78	100 +	\$56.54	 <table border="1"> <thead> <tr> <th colspan="2">PRICE</th> </tr> </thead> <tbody> <tr> <td>1-24</td> <td>\$104.12</td> </tr> <tr> <td>25-49</td> <td>\$96.83</td> </tr> <tr> <td>50-99</td> <td>\$89.54</td> </tr> <tr> <td>100 +</td> <td>\$83.30</td> </tr> </tbody> </table> <p><b>PRECISION</b> <b>Model No: PE9491</b> N Male To BNC Female Max VSWR 1.20:1 @ 8 GHz</p>	PRICE		1-24	\$104.12	25-49	\$96.83	50-99	\$89.54	100 +	\$83.30
	PRICE																																											
1-24	\$106.35																																											
25-49	\$98.91																																											
50-99	\$91.46																																											
100 +	\$85.08																																											
PRICE																																												
1-24	\$31.77																																											
25-49	\$29.55																																											
50-99	\$27.32																																											
100 +	\$25.42																																											
PRICE																																												
1-24	\$70.68																																											
25-49	\$65.73																																											
50-99	\$60.78																																											
100 +	\$56.54																																											
PRICE																																												
1-24	\$104.12																																											
25-49	\$96.83																																											
50-99	\$89.54																																											
100 +	\$83.30																																											
6	 <table border="1"> <thead> <tr> <th colspan="2">PRICE</th> </tr> </thead> <tbody> <tr> <td>1-24</td> <td>\$14.21</td> </tr> <tr> <td>25-49</td> <td>\$13.22</td> </tr> <tr> <td>50-99</td> <td>\$12.22</td> </tr> <tr> <td>100 +</td> <td>\$11.37</td> </tr> </tbody> </table> <p><b>Model No: PE9002</b> N Male To BNC Female</p>	PRICE		1-24	\$14.21	25-49	\$13.22	50-99	\$12.22	100 +	\$11.37	 <table border="1"> <thead> <tr> <th colspan="2">PRICE</th> </tr> </thead> <tbody> <tr> <td>1-24</td> <td>\$41.14</td> </tr> <tr> <td>25-49</td> <td>\$38.26</td> </tr> <tr> <td>50-99</td> <td>\$35.38</td> </tr> <tr> <td>100 +</td> <td>\$32.91</td> </tr> </tbody> </table> <p><b>Model No: PE9388</b> N Male To BNC Female Panel Mount Mounting Hole A05</p>	PRICE		1-24	\$41.14	25-49	\$38.26	50-99	\$35.38	100 +	\$32.91	 <table border="1"> <thead> <tr> <th colspan="2">PRICE</th> </tr> </thead> <tbody> <tr> <td>1-24</td> <td>\$44.74</td> </tr> <tr> <td>25-49</td> <td>\$41.61</td> </tr> <tr> <td>50-99</td> <td>\$38.48</td> </tr> <tr> <td>100 +</td> <td>\$35.79</td> </tr> </tbody> </table> <p><b>Model No: PE9278</b> N Male To BNC Female Right Angle</p>	PRICE		1-24	\$44.74	25-49	\$41.61	50-99	\$38.48	100 +	\$35.79	 <table border="1"> <thead> <tr> <th colspan="2">PRICE</th> </tr> </thead> <tbody> <tr> <td>1-24</td> <td>\$104.12</td> </tr> <tr> <td>25-49</td> <td>\$96.83</td> </tr> <tr> <td>50-99</td> <td>\$89.54</td> </tr> <tr> <td>100 +</td> <td>\$83.30</td> </tr> </tbody> </table> <p><b>PRECISION</b> <b>Model No: PE9490</b> N Female To BNC Male Max VSWR 1.20:1 @ 8 GHz</p>	PRICE		1-24	\$104.12	25-49	\$96.83	50-99	\$89.54	100 +	\$83.30
	PRICE																																											
1-24	\$14.21																																											
25-49	\$13.22																																											
50-99	\$12.22																																											
100 +	\$11.37																																											
PRICE																																												
1-24	\$41.14																																											
25-49	\$38.26																																											
50-99	\$35.38																																											
100 +	\$32.91																																											
PRICE																																												
1-24	\$44.74																																											
25-49	\$41.61																																											
50-99	\$38.48																																											
100 +	\$35.79																																											
PRICE																																												
1-24	\$104.12																																											
25-49	\$96.83																																											
50-99	\$89.54																																											
100 +	\$83.30																																											

Adapters

See Our Website For Real-Time Stock Availability!













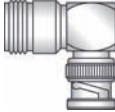
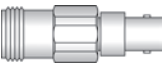

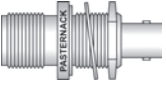



# ADAPTERS

See Adapter Locator on Pages 140-145 or the Adapter Matrix on Pages 138-139

See Page 246 for Mounting Holes

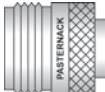
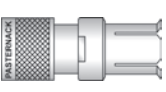
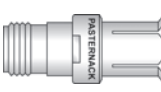
Adapters

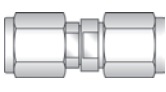
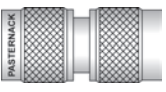











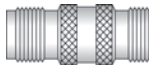
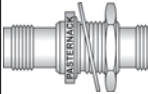
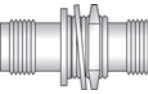

See Our Website For Real-Time Stock Availability!

	A	B	C	D																																								
1	 <table border="1"> <thead> <tr> <th colspan="2">PRICE</th> </tr> </thead> <tbody> <tr> <td>1-24</td> <td>\$12.96</td> </tr> <tr> <td>25-49</td> <td>\$12.05</td> </tr> <tr> <td>50-99</td> <td>\$11.15</td> </tr> <tr> <td>100 +</td> <td>\$10.37</td> </tr> </tbody> </table> <p><b>Model No: PE9005</b> N Female To BNC Male</p>	PRICE		1-24	\$12.96	25-49	\$12.05	50-99	\$11.15	100 +	\$10.37	 <table border="1"> <thead> <tr> <th colspan="2">PRICE</th> </tr> </thead> <tbody> <tr> <td>1-24</td> <td>\$58.87</td> </tr> <tr> <td>25-49</td> <td>\$54.75</td> </tr> <tr> <td>50-99</td> <td>\$50.63</td> </tr> <tr> <td>100 +</td> <td>\$47.10</td> </tr> </tbody> </table> <p><b>Model No: PE9123</b> N Female To BNC Male Panel Mount Mounting Hole A05</p>	PRICE		1-24	\$58.87	25-49	\$54.75	50-99	\$50.63	100 +	\$47.10	 <table border="1"> <thead> <tr> <th colspan="2">PRICE</th> </tr> </thead> <tbody> <tr> <td>1-24</td> <td>\$47.27</td> </tr> <tr> <td>25-49</td> <td>\$43.96</td> </tr> <tr> <td>50-99</td> <td>\$40.65</td> </tr> <tr> <td>100 +</td> <td>\$37.82</td> </tr> </tbody> </table> <p><b>Model No: PE9566</b> N Female To BNC Male Right Angle</p>	PRICE		1-24	\$47.27	25-49	\$43.96	50-99	\$40.65	100 +	\$37.82	 <table border="1"> <thead> <tr> <th colspan="2">PRICE</th> </tr> </thead> <tbody> <tr> <td>1-24</td> <td>\$104.12</td> </tr> <tr> <td>25-49</td> <td>\$96.83</td> </tr> <tr> <td>50-99</td> <td>\$89.54</td> </tr> <tr> <td>100 +</td> <td>\$83.30</td> </tr> </tbody> </table> <p><b>PRECISION</b> <b>Model No: PE9492</b> N Female To BNC Female Max VSWR 1.20:1 @ 8 GHz</p>	PRICE		1-24	\$104.12	25-49	\$96.83	50-99	\$89.54	100 +	\$83.30
	PRICE																																											
1-24	\$12.96																																											
25-49	\$12.05																																											
50-99	\$11.15																																											
100 +	\$10.37																																											
PRICE																																												
1-24	\$58.87																																											
25-49	\$54.75																																											
50-99	\$50.63																																											
100 +	\$47.10																																											
PRICE																																												
1-24	\$47.27																																											
25-49	\$43.96																																											
50-99	\$40.65																																											
100 +	\$37.82																																											
PRICE																																												
1-24	\$104.12																																											
25-49	\$96.83																																											
50-99	\$89.54																																											
100 +	\$83.30																																											
2	 <table border="1"> <thead> <tr> <th colspan="2">PRICE</th> </tr> </thead> <tbody> <tr> <td>1-24</td> <td>\$20.32</td> </tr> <tr> <td>25-49</td> <td>\$18.90</td> </tr> <tr> <td>50-99</td> <td>\$17.48</td> </tr> <tr> <td>100 +</td> <td>\$16.26</td> </tr> </tbody> </table> <p><b>Model No: PE9206</b> N Female To BNC Female</p>	PRICE		1-24	\$20.32	25-49	\$18.90	50-99	\$17.48	100 +	\$16.26	 <table border="1"> <thead> <tr> <th colspan="2">PRICE</th> </tr> </thead> <tbody> <tr> <td>1-24</td> <td>\$44.74</td> </tr> <tr> <td>25-49</td> <td>\$41.61</td> </tr> <tr> <td>50-99</td> <td>\$38.48</td> </tr> <tr> <td>100 +</td> <td>\$35.79</td> </tr> </tbody> </table> <p><b>Model No: PE9261</b> N Female To BNC Female Bulkhead Mounting Hole G01</p>	PRICE		1-24	\$44.74	25-49	\$41.61	50-99	\$38.48	100 +	\$35.79	 <table border="1"> <thead> <tr> <th colspan="2">PRICE</th> </tr> </thead> <tbody> <tr> <td>1-24</td> <td>\$45.90</td> </tr> <tr> <td>25-49</td> <td>\$42.69</td> </tr> <tr> <td>50-99</td> <td>\$39.47</td> </tr> <tr> <td>100 +</td> <td>\$36.72</td> </tr> </tbody> </table> <p><b>Model No: PE9540</b> N Female Bulkhead To BNC Female, Mounts From N Female Side Mounting Hole G01</p>	PRICE		1-24	\$45.90	25-49	\$42.69	50-99	\$39.47	100 +	\$36.72	 <table border="1"> <thead> <tr> <th colspan="2">PRICE</th> </tr> </thead> <tbody> <tr> <td>1-24</td> <td>\$32.12</td> </tr> <tr> <td>25-49</td> <td>\$29.87</td> </tr> <tr> <td>50-99</td> <td>\$27.62</td> </tr> <tr> <td>100 +</td> <td>\$25.70</td> </tr> </tbody> </table> <p><b>Model No: PE9238</b> N Female To BNC Female Panel Mount Mounting Hole A05</p>	PRICE		1-24	\$32.12	25-49	\$29.87	50-99	\$27.62	100 +	\$25.70
	PRICE																																											
1-24	\$20.32																																											
25-49	\$18.90																																											
50-99	\$17.48																																											
100 +	\$16.26																																											
PRICE																																												
1-24	\$44.74																																											
25-49	\$41.61																																											
50-99	\$38.48																																											
100 +	\$35.79																																											
PRICE																																												
1-24	\$45.90																																											
25-49	\$42.69																																											
50-99	\$39.47																																											
100 +	\$36.72																																											
PRICE																																												
1-24	\$32.12																																											
25-49	\$29.87																																											
50-99	\$27.62																																											
100 +	\$25.70																																											
3	 <table border="1"> <thead> <tr> <th colspan="2">PRICE</th> </tr> </thead> <tbody> <tr> <td>1-24</td> <td>\$47.12</td> </tr> <tr> <td>25-49</td> <td>\$43.82</td> </tr> <tr> <td>50-99</td> <td>\$40.52</td> </tr> <tr> <td>100 +</td> <td>\$37.70</td> </tr> </tbody> </table> <p><b>Model No: PE9538</b> N Male To C Male</p>	PRICE		1-24	\$47.12	25-49	\$43.82	50-99	\$40.52	100 +	\$37.70	 <table border="1"> <thead> <tr> <th colspan="2">PRICE</th> </tr> </thead> <tbody> <tr> <td>1-24</td> <td>\$48.33</td> </tr> <tr> <td>25-49</td> <td>\$44.95</td> </tr> <tr> <td>50-99</td> <td>\$41.56</td> </tr> <tr> <td>100 +</td> <td>\$38.66</td> </tr> </tbody> </table> <p><b>Model No: PE9124</b> N Male To C Female</p>	PRICE		1-24	\$48.33	25-49	\$44.95	50-99	\$41.56	100 +	\$38.66	 <table border="1"> <thead> <tr> <th colspan="2">PRICE</th> </tr> </thead> <tbody> <tr> <td>1-24</td> <td>\$70.68</td> </tr> <tr> <td>25-49</td> <td>\$65.73</td> </tr> <tr> <td>50-99</td> <td>\$60.78</td> </tr> <tr> <td>100 +</td> <td>\$56.54</td> </tr> </tbody> </table> <p><b>Model No: PE9239</b> N Male To C Female Right Angle</p>	PRICE		1-24	\$70.68	25-49	\$65.73	50-99	\$60.78	100 +	\$56.54	 <table border="1"> <thead> <tr> <th colspan="2">PRICE</th> </tr> </thead> <tbody> <tr> <td>1-24</td> <td>\$43.22</td> </tr> <tr> <td>25-49</td> <td>\$40.19</td> </tr> <tr> <td>50-99</td> <td>\$37.17</td> </tr> <tr> <td>100 +</td> <td>\$34.58</td> </tr> </tbody> </table> <p><b>Model No: PE9295</b> N Female To C Male</p>	PRICE		1-24	\$43.22	25-49	\$40.19	50-99	\$37.17	100 +	\$34.58
	PRICE																																											
1-24	\$47.12																																											
25-49	\$43.82																																											
50-99	\$40.52																																											
100 +	\$37.70																																											
PRICE																																												
1-24	\$48.33																																											
25-49	\$44.95																																											
50-99	\$41.56																																											
100 +	\$38.66																																											
PRICE																																												
1-24	\$70.68																																											
25-49	\$65.73																																											
50-99	\$60.78																																											
100 +	\$56.54																																											
PRICE																																												
1-24	\$43.22																																											
25-49	\$40.19																																											
50-99	\$37.17																																											
100 +	\$34.58																																											
4	 <table border="1"> <thead> <tr> <th colspan="2">PRICE</th> </tr> </thead> <tbody> <tr> <td>1-24</td> <td>\$47.12</td> </tr> <tr> <td>25-49</td> <td>\$43.82</td> </tr> <tr> <td>50-99</td> <td>\$40.52</td> </tr> <tr> <td>100 +</td> <td>\$37.70</td> </tr> </tbody> </table> <p><b>Model No: PE9539</b> N Female To C Female</p>	PRICE		1-24	\$47.12	25-49	\$43.82	50-99	\$40.52	100 +	\$37.70	 <table border="1"> <thead> <tr> <th colspan="2">PRICE</th> </tr> </thead> <tbody> <tr> <td>1-24</td> <td>\$36.58</td> </tr> <tr> <td>25-49</td> <td>\$34.02</td> </tr> <tr> <td>50-99</td> <td>\$31.46</td> </tr> <tr> <td>100 +</td> <td>\$29.26</td> </tr> </tbody> </table> <p><b>Model No: PE9349</b> 50 Ohm N Male To 75 Ohm N Female</p>	PRICE		1-24	\$36.58	25-49	\$34.02	50-99	\$31.46	100 +	\$29.26	 <table border="1"> <thead> <tr> <th colspan="2">PRICE</th> </tr> </thead> <tbody> <tr> <td>1-24</td> <td>\$31.36</td> </tr> <tr> <td>25-49</td> <td>\$29.16</td> </tr> <tr> <td>50-99</td> <td>\$26.97</td> </tr> <tr> <td>100 +</td> <td>\$25.09</td> </tr> </tbody> </table> <p><b>Model No: PE9350</b> 50 Ohm N Female To 75 Ohm N Male</p>	PRICE		1-24	\$31.36	25-49	\$29.16	50-99	\$26.97	100 +	\$25.09	 <table border="1"> <thead> <tr> <th colspan="2">PRICE</th> </tr> </thead> <tbody> <tr> <td>1-24</td> <td>\$19.83</td> </tr> <tr> <td>25-49</td> <td>\$18.44</td> </tr> <tr> <td>50-99</td> <td>\$17.05</td> </tr> <tr> <td>100 +</td> <td>\$15.86</td> </tr> </tbody> </table> <p><b>Model No: PE9155</b> N Male To F Female</p>	PRICE		1-24	\$19.83	25-49	\$18.44	50-99	\$17.05	100 +	\$15.86
	PRICE																																											
1-24	\$47.12																																											
25-49	\$43.82																																											
50-99	\$40.52																																											
100 +	\$37.70																																											
PRICE																																												
1-24	\$36.58																																											
25-49	\$34.02																																											
50-99	\$31.46																																											
100 +	\$29.26																																											
PRICE																																												
1-24	\$31.36																																											
25-49	\$29.16																																											
50-99	\$26.97																																											
100 +	\$25.09																																											
PRICE																																												
1-24	\$19.83																																											
25-49	\$18.44																																											
50-99	\$17.05																																											
100 +	\$15.86																																											
5	 <table border="1"> <thead> <tr> <th colspan="2">PRICE</th> </tr> </thead> <tbody> <tr> <td>1-24</td> <td>\$27.00</td> </tr> <tr> <td>25-49</td> <td>\$25.11</td> </tr> <tr> <td>50-99</td> <td>\$23.22</td> </tr> <tr> <td>100 +</td> <td>\$21.60</td> </tr> </tbody> </table> <p><b>Model No: PE9389</b> N Female To F Male</p>	PRICE		1-24	\$27.00	25-49	\$25.11	50-99	\$23.22	100 +	\$21.60	 <table border="1"> <thead> <tr> <th colspan="2">PRICE</th> </tr> </thead> <tbody> <tr> <td>1-24</td> <td>\$130.36</td> </tr> <tr> <td>25-49</td> <td>\$121.23</td> </tr> <tr> <td>50-99</td> <td>\$112.11</td> </tr> <tr> <td>100 +</td> <td>\$104.29</td> </tr> </tbody> </table> <p><b>Model No: PE9257</b> N Male To GR874</p>	PRICE		1-24	\$130.36	25-49	\$121.23	50-99	\$112.11	100 +	\$104.29	 <table border="1"> <thead> <tr> <th colspan="2">PRICE</th> </tr> </thead> <tbody> <tr> <td>1-24</td> <td>\$130.36</td> </tr> <tr> <td>25-49</td> <td>\$121.23</td> </tr> <tr> <td>50-99</td> <td>\$112.11</td> </tr> <tr> <td>100 +</td> <td>\$104.29</td> </tr> </tbody> </table> <p><b>Model No: PE9258</b> N Female To GR874</p>	PRICE		1-24	\$130.36	25-49	\$121.23	50-99	\$112.11	100 +	\$104.29	<div style="background-color: black; color: white; padding: 20px; text-align: center;"> <h2>TNC In-Series</h2>  </div>										
	PRICE																																											
1-24	\$27.00																																											
25-49	\$25.11																																											
50-99	\$23.22																																											
100 +	\$21.60																																											
PRICE																																												
1-24	\$130.36																																											
25-49	\$121.23																																											
50-99	\$112.11																																											
100 +	\$104.29																																											
PRICE																																												
1-24	\$130.36																																											
25-49	\$121.23																																											
50-99	\$112.11																																											
100 +	\$104.29																																											
6	 <table border="1"> <thead> <tr> <th colspan="2">PRICE</th> </tr> </thead> <tbody> <tr> <td>1-24</td> <td>\$94.08</td> </tr> <tr> <td>25-49</td> <td>\$87.49</td> </tr> <tr> <td>50-99</td> <td>\$80.91</td> </tr> <tr> <td>100 +</td> <td>\$75.26</td> </tr> </tbody> </table> <p><b>PRECISION</b> <b>Model No: PE9445</b> TNC Male To TNC Male Max VSWR 1.25:1 @ 18 GHz</p>	PRICE		1-24	\$94.08	25-49	\$87.49	50-99	\$80.91	100 +	\$75.26	 <table border="1"> <thead> <tr> <th colspan="2">PRICE</th> </tr> </thead> <tbody> <tr> <td>1-24</td> <td>\$18.24</td> </tr> <tr> <td>25-49</td> <td>\$16.96</td> </tr> <tr> <td>50-99</td> <td>\$15.69</td> </tr> <tr> <td>100 +</td> <td>\$14.59</td> </tr> </tbody> </table> <p><b>Model No: PE9091</b> TNC Male To TNC Male</p>	PRICE		1-24	\$18.24	25-49	\$16.96	50-99	\$15.69	100 +	\$14.59	 <table border="1"> <thead> <tr> <th colspan="2">PRICE</th> </tr> </thead> <tbody> <tr> <td>1-24</td> <td>\$49.30</td> </tr> <tr> <td>25-49</td> <td>\$45.85</td> </tr> <tr> <td>50-99</td> <td>\$42.40</td> </tr> <tr> <td>100 +</td> <td>\$39.44</td> </tr> </tbody> </table> <p><b>Model No: PE9560</b> TNC Male To TNC Male Right Angle</p>	PRICE		1-24	\$49.30	25-49	\$45.85	50-99	\$42.40	100 +	\$39.44	 <table border="1"> <thead> <tr> <th colspan="2">PRICE</th> </tr> </thead> <tbody> <tr> <td>1-24</td> <td>\$94.08</td> </tr> <tr> <td>25-49</td> <td>\$87.49</td> </tr> <tr> <td>50-99</td> <td>\$80.91</td> </tr> <tr> <td>100 +</td> <td>\$75.26</td> </tr> </tbody> </table> <p><b>PRECISION</b> <b>Model No: PE9443</b> TNC Male To TNC Female Max VSWR 1.25:1 @ 18 GHz</p>	PRICE		1-24	\$94.08	25-49	\$87.49	50-99	\$80.91	100 +	\$75.26
	PRICE																																											
1-24	\$94.08																																											
25-49	\$87.49																																											
50-99	\$80.91																																											
100 +	\$75.26																																											
PRICE																																												
1-24	\$18.24																																											
25-49	\$16.96																																											
50-99	\$15.69																																											
100 +	\$14.59																																											
PRICE																																												
1-24	\$49.30																																											
25-49	\$45.85																																											
50-99	\$42.40																																											
100 +	\$39.44																																											
PRICE																																												
1-24	\$94.08																																											
25-49	\$87.49																																											
50-99	\$80.91																																											
100 +	\$75.26																																											

# ADAPTERS

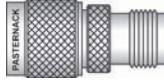
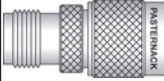
See Adapter Locator on Pages 140-145 or the Adapter Matrix on Pages 138-139

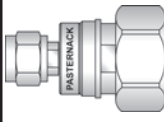
See Page 246 for Mounting Holes

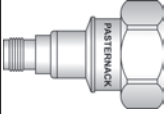
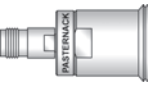
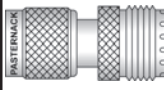
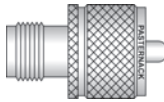
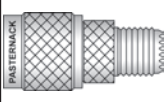
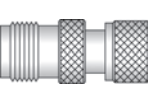
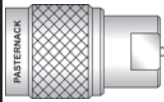
	A	B	C	D																																								
1	 <table border="1"> <thead> <tr> <th colspan="2">PRICE</th> </tr> </thead> <tbody> <tr> <td>1-24</td> <td>\$141.15</td> </tr> <tr> <td>25-49</td> <td>\$131.27</td> </tr> <tr> <td>50-99</td> <td>\$121.39</td> </tr> <tr> <td>100 +</td> <td>\$112.92</td> </tr> </tbody> </table> <p><b>Model No: PE9561</b> TNC Male Quick Disconnect To TNC Female</p>	PRICE		1-24	\$141.15	25-49	\$131.27	50-99	\$121.39	100 +	\$112.92	 <table border="1"> <thead> <tr> <th colspan="2">PRICE</th> </tr> </thead> <tbody> <tr> <td>1-24</td> <td>\$33.78</td> </tr> <tr> <td>25-49</td> <td>\$31.42</td> </tr> <tr> <td>50-99</td> <td>\$29.05</td> </tr> <tr> <td>100 +</td> <td>\$27.02</td> </tr> </tbody> </table> <p><b>Model No: PE9100</b> TNC Male To TNC Female Right Angle</p>	PRICE		1-24	\$33.78	25-49	\$31.42	50-99	\$29.05	100 +	\$27.02	 <table border="1"> <thead> <tr> <th colspan="2">PRICE</th> </tr> </thead> <tbody> <tr> <td>1-24</td> <td>\$15.86</td> </tr> <tr> <td>25-49</td> <td>\$14.75</td> </tr> <tr> <td>50-99</td> <td>\$13.64</td> </tr> <tr> <td>100 +</td> <td>\$12.69</td> </tr> </tbody> </table> <p><b>Model No: PE9270</b> TNC Male To TNC Female</p>	PRICE		1-24	\$15.86	25-49	\$14.75	50-99	\$13.64	100 +	\$12.69	 <table border="1"> <thead> <tr> <th colspan="2">PRICE</th> </tr> </thead> <tbody> <tr> <td>1-24</td> <td>\$92.56</td> </tr> <tr> <td>25-49</td> <td>\$86.08</td> </tr> <tr> <td>50-99</td> <td>\$79.60</td> </tr> <tr> <td>100 +</td> <td>\$74.05</td> </tr> </tbody> </table> <p><b>PRECISION</b> <b>Model No: PE9444</b> TNC Female To TNC Female Max VSWR 1.25:1 @ 18 GHz</p>	PRICE		1-24	\$92.56	25-49	\$86.08	50-99	\$79.60	100 +	\$74.05
	PRICE																																											
1-24	\$141.15																																											
25-49	\$131.27																																											
50-99	\$121.39																																											
100 +	\$112.92																																											
PRICE																																												
1-24	\$33.78																																											
25-49	\$31.42																																											
50-99	\$29.05																																											
100 +	\$27.02																																											
PRICE																																												
1-24	\$15.86																																											
25-49	\$14.75																																											
50-99	\$13.64																																											
100 +	\$12.69																																											
PRICE																																												
1-24	\$92.56																																											
25-49	\$86.08																																											
50-99	\$79.60																																											
100 +	\$74.05																																											
2	 <table border="1"> <thead> <tr> <th colspan="2">PRICE</th> </tr> </thead> <tbody> <tr> <td>1-24</td> <td>\$19.41</td> </tr> <tr> <td>25-49</td> <td>\$18.05</td> </tr> <tr> <td>50-99</td> <td>\$16.69</td> </tr> <tr> <td>100 +</td> <td>\$15.53</td> </tr> </tbody> </table> <p><b>Model No: PE9099</b> TNC Female To TNC Female</p>	PRICE		1-24	\$19.41	25-49	\$18.05	50-99	\$16.69	100 +	\$15.53	 <table border="1"> <thead> <tr> <th colspan="2">PRICE</th> </tr> </thead> <tbody> <tr> <td>1-24</td> <td>\$18.24</td> </tr> <tr> <td>25-49</td> <td>\$16.96</td> </tr> <tr> <td>50-99</td> <td>\$15.69</td> </tr> <tr> <td>100 +</td> <td>\$14.59</td> </tr> </tbody> </table> <p><b>Model No: PE9154</b> TNC Female To TNC Female Bulkhead, Hermetically Sealed Mounting Hole B06</p>	PRICE		1-24	\$18.24	25-49	\$16.96	50-99	\$15.69	100 +	\$14.59	 <table border="1"> <thead> <tr> <th colspan="2">PRICE</th> </tr> </thead> <tbody> <tr> <td>1-24</td> <td>\$20.52</td> </tr> <tr> <td>25-49</td> <td>\$19.08</td> </tr> <tr> <td>50-99</td> <td>\$17.65</td> </tr> <tr> <td>100 +</td> <td>\$16.42</td> </tr> </tbody> </table> <p><b>Model No: PE9287</b> TNC Female To TNC Female Bulkhead, Isolated Ground Mounting Hole B06</p>	PRICE		1-24	\$20.52	25-49	\$19.08	50-99	\$17.65	100 +	\$16.42	 <table border="1"> <thead> <tr> <th colspan="2">PRICE</th> </tr> </thead> <tbody> <tr> <td>1-24</td> <td>\$12.06</td> </tr> <tr> <td>25-49</td> <td>\$11.22</td> </tr> <tr> <td>50-99</td> <td>\$10.37</td> </tr> <tr> <td>100 +</td> <td>\$9.65</td> </tr> </tbody> </table> <p><b>Model No: PE9288</b> TNC Female To TNC Female Panel Mount Mounting Hole A03</p>	PRICE		1-24	\$12.06	25-49	\$11.22	50-99	\$10.37	100 +	\$9.65
	PRICE																																											
1-24	\$19.41																																											
25-49	\$18.05																																											
50-99	\$16.69																																											
100 +	\$15.53																																											
PRICE																																												
1-24	\$18.24																																											
25-49	\$16.96																																											
50-99	\$15.69																																											
100 +	\$14.59																																											
PRICE																																												
1-24	\$20.52																																											
25-49	\$19.08																																											
50-99	\$17.65																																											
100 +	\$16.42																																											
PRICE																																												
1-24	\$12.06																																											
25-49	\$11.22																																											
50-99	\$10.37																																											
100 +	\$9.65																																											
3	 <table border="1"> <thead> <tr> <th colspan="2">PRICE</th> </tr> </thead> <tbody> <tr> <td>1-24</td> <td>\$16.87</td> </tr> <tr> <td>25-49</td> <td>\$15.69</td> </tr> <tr> <td>50-99</td> <td>\$14.51</td> </tr> <tr> <td>100 +</td> <td>\$13.50</td> </tr> </tbody> </table> <p><b>Model No: PE9195</b> TNC "T" Female-Male-Female</p>	PRICE		1-24	\$16.87	25-49	\$15.69	50-99	\$14.51	100 +	\$13.50	 <table border="1"> <thead> <tr> <th colspan="2">PRICE</th> </tr> </thead> <tbody> <tr> <td>1-24</td> <td>\$41.14</td> </tr> <tr> <td>25-49</td> <td>\$38.26</td> </tr> <tr> <td>50-99</td> <td>\$35.38</td> </tr> <tr> <td>100 +</td> <td>\$32.91</td> </tr> </tbody> </table> <p><b>Model No: PE9290</b> TNC "T" Male-Female-Female</p>	PRICE		1-24	\$41.14	25-49	\$38.26	50-99	\$35.38	100 +	\$32.91	 <table border="1"> <thead> <tr> <th colspan="2">PRICE</th> </tr> </thead> <tbody> <tr> <td>1-24</td> <td>\$23.36</td> </tr> <tr> <td>25-49</td> <td>\$21.72</td> </tr> <tr> <td>50-99</td> <td>\$20.09</td> </tr> <tr> <td>100 +</td> <td>\$18.69</td> </tr> </tbody> </table> <p><b>Model No: PE9289</b> TNC "T" Female-Female-Female</p>	PRICE		1-24	\$23.36	25-49	\$21.72	50-99	\$20.09	100 +	\$18.69	 <table border="1"> <thead> <tr> <th colspan="2">PRICE</th> </tr> </thead> <tbody> <tr> <td>1-24</td> <td>\$18.75</td> </tr> <tr> <td>25-49</td> <td>\$17.44</td> </tr> <tr> <td>50-99</td> <td>\$16.13</td> </tr> <tr> <td>100 +</td> <td>\$15.00</td> </tr> </tbody> </table> <p><b>PRECISION</b> <b>Model No: PE9918</b> Reverse Polarity TNC Male To Reverse Polarity TNC Female, Right Angle Max VSWR 1.25:1 @ 11 GHz</p>	PRICE		1-24	\$18.75	25-49	\$17.44	50-99	\$16.13	100 +	\$15.00
	PRICE																																											
1-24	\$16.87																																											
25-49	\$15.69																																											
50-99	\$14.51																																											
100 +	\$13.50																																											
PRICE																																												
1-24	\$41.14																																											
25-49	\$38.26																																											
50-99	\$35.38																																											
100 +	\$32.91																																											
PRICE																																												
1-24	\$23.36																																											
25-49	\$21.72																																											
50-99	\$20.09																																											
100 +	\$18.69																																											
PRICE																																												
1-24	\$18.75																																											
25-49	\$17.44																																											
50-99	\$16.13																																											
100 +	\$15.00																																											
4	 <table border="1"> <thead> <tr> <th colspan="2">PRICE</th> </tr> </thead> <tbody> <tr> <td>1-24</td> <td>\$28.93</td> </tr> <tr> <td>25-49</td> <td>\$26.90</td> </tr> <tr> <td>50-99</td> <td>\$24.88</td> </tr> <tr> <td>100 +</td> <td>\$23.14</td> </tr> </tbody> </table> <p><b>Model No: PE9532</b> Standard TNC Male To Reverse Polarity TNC Female</p>	PRICE		1-24	\$28.93	25-49	\$26.90	50-99	\$24.88	100 +	\$23.14	 <table border="1"> <thead> <tr> <th colspan="2">PRICE</th> </tr> </thead> <tbody> <tr> <td>1-24</td> <td>\$29.39</td> </tr> <tr> <td>25-49</td> <td>\$27.33</td> </tr> <tr> <td>50-99</td> <td>\$25.28</td> </tr> <tr> <td>100 +</td> <td>\$23.51</td> </tr> </tbody> </table> <p><b>Model No: PE9531</b> Standard TNC Female To Reverse Polarity TNC Male</p>	PRICE		1-24	\$29.39	25-49	\$27.33	50-99	\$25.28	100 +	\$23.51	<p><b>TNC</b> <b>Between-Series</b></p> 		 <table border="1"> <thead> <tr> <th colspan="2">PRICE</th> </tr> </thead> <tbody> <tr> <td>1-24</td> <td>\$200.13</td> </tr> <tr> <td>25-49</td> <td>\$186.12</td> </tr> <tr> <td>50-99</td> <td>\$172.11</td> </tr> <tr> <td>100 +</td> <td>\$160.10</td> </tr> </tbody> </table> <p><b>Model No: PE9637</b> TNC Male To 7/16 Male</p>	PRICE		1-24	\$200.13	25-49	\$186.12	50-99	\$172.11	100 +	\$160.10									
	PRICE																																											
1-24	\$28.93																																											
25-49	\$26.90																																											
50-99	\$24.88																																											
100 +	\$23.14																																											
PRICE																																												
1-24	\$29.39																																											
25-49	\$27.33																																											
50-99	\$25.28																																											
100 +	\$23.51																																											
PRICE																																												
1-24	\$200.13																																											
25-49	\$186.12																																											
50-99	\$172.11																																											
100 +	\$160.10																																											
5	 <table border="1"> <thead> <tr> <th colspan="2">PRICE</th> </tr> </thead> <tbody> <tr> <td>1-24</td> <td>\$188.37</td> </tr> <tr> <td>25-49</td> <td>\$175.18</td> </tr> <tr> <td>50-99</td> <td>\$162.00</td> </tr> <tr> <td>100 +</td> <td>\$150.70</td> </tr> </tbody> </table> <p><b>Model No: PE9638</b> TNC Male To 7/16 Female</p>	PRICE		1-24	\$188.37	25-49	\$175.18	50-99	\$162.00	100 +	\$150.70	 <table border="1"> <thead> <tr> <th colspan="2">PRICE</th> </tr> </thead> <tbody> <tr> <td>1-24</td> <td>\$200.13</td> </tr> <tr> <td>25-49</td> <td>\$186.12</td> </tr> <tr> <td>50-99</td> <td>\$172.11</td> </tr> <tr> <td>100 +</td> <td>\$160.10</td> </tr> </tbody> </table> <p><b>Model No: PE9636</b> TNC Female To 7/16 Male</p>	PRICE		1-24	\$200.13	25-49	\$186.12	50-99	\$172.11	100 +	\$160.10	 <table border="1"> <thead> <tr> <th colspan="2">PRICE</th> </tr> </thead> <tbody> <tr> <td>1-24</td> <td>\$200.13</td> </tr> <tr> <td>25-49</td> <td>\$186.12</td> </tr> <tr> <td>50-99</td> <td>\$172.11</td> </tr> <tr> <td>100 +</td> <td>\$160.10</td> </tr> </tbody> </table> <p><b>Model No: PE9639</b> TNC Female To 7/16 Female</p>	PRICE		1-24	\$200.13	25-49	\$186.12	50-99	\$172.11	100 +	\$160.10	 <table border="1"> <thead> <tr> <th colspan="2">PRICE</th> </tr> </thead> <tbody> <tr> <td>1-24</td> <td>\$14.69</td> </tr> <tr> <td>25-49</td> <td>\$13.66</td> </tr> <tr> <td>50-99</td> <td>\$12.63</td> </tr> <tr> <td>100 +</td> <td>\$11.75</td> </tr> </tbody> </table> <p><b>Model No: PE9291</b> TNC Male To UHF Female</p>	PRICE		1-24	\$14.69	25-49	\$13.66	50-99	\$12.63	100 +	\$11.75
	PRICE																																											
1-24	\$188.37																																											
25-49	\$175.18																																											
50-99	\$162.00																																											
100 +	\$150.70																																											
PRICE																																												
1-24	\$200.13																																											
25-49	\$186.12																																											
50-99	\$172.11																																											
100 +	\$160.10																																											
PRICE																																												
1-24	\$200.13																																											
25-49	\$186.12																																											
50-99	\$172.11																																											
100 +	\$160.10																																											
PRICE																																												
1-24	\$14.69																																											
25-49	\$13.66																																											
50-99	\$12.63																																											
100 +	\$11.75																																											
6	 <table border="1"> <thead> <tr> <th colspan="2">PRICE</th> </tr> </thead> <tbody> <tr> <td>1-24</td> <td>\$15.91</td> </tr> <tr> <td>25-49</td> <td>\$14.80</td> </tr> <tr> <td>50-99</td> <td>\$13.68</td> </tr> <tr> <td>100 +</td> <td>\$12.73</td> </tr> </tbody> </table> <p><b>Model No: PE9372</b> TNC Female To UHF Male</p>	PRICE		1-24	\$15.91	25-49	\$14.80	50-99	\$13.68	100 +	\$12.73	 <table border="1"> <thead> <tr> <th colspan="2">PRICE</th> </tr> </thead> <tbody> <tr> <td>1-24</td> <td>\$10.99</td> </tr> <tr> <td>25-49</td> <td>\$10.22</td> </tr> <tr> <td>50-99</td> <td>\$9.45</td> </tr> <tr> <td>100 +</td> <td>\$8.79</td> </tr> </tbody> </table> <p><b>Model No: PE9345</b> TNC Male To Mini-UHF Female</p>	PRICE		1-24	\$10.99	25-49	\$10.22	50-99	\$9.45	100 +	\$8.79	 <table border="1"> <thead> <tr> <th colspan="2">PRICE</th> </tr> </thead> <tbody> <tr> <td>1-24</td> <td>\$10.99</td> </tr> <tr> <td>25-49</td> <td>\$10.22</td> </tr> <tr> <td>50-99</td> <td>\$9.45</td> </tr> <tr> <td>100 +</td> <td>\$8.79</td> </tr> </tbody> </table> <p><b>Model No: PE9346</b> TNC Female To Mini-UHF Male</p>	PRICE		1-24	\$10.99	25-49	\$10.22	50-99	\$9.45	100 +	\$8.79	 <table border="1"> <thead> <tr> <th colspan="2">PRICE</th> </tr> </thead> <tbody> <tr> <td>1-24</td> <td>\$11.70</td> </tr> <tr> <td>25-49</td> <td>\$10.88</td> </tr> <tr> <td>50-99</td> <td>\$10.06</td> </tr> <tr> <td>100 +</td> <td>\$9.36</td> </tr> </tbody> </table> <p><b>Model No: PE9699</b> TNC Male To FME Plug</p>	PRICE		1-24	\$11.70	25-49	\$10.88	50-99	\$10.06	100 +	\$9.36
	PRICE																																											
1-24	\$15.91																																											
25-49	\$14.80																																											
50-99	\$13.68																																											
100 +	\$12.73																																											
PRICE																																												
1-24	\$10.99																																											
25-49	\$10.22																																											
50-99	\$9.45																																											
100 +	\$8.79																																											
PRICE																																												
1-24	\$10.99																																											
25-49	\$10.22																																											
50-99	\$9.45																																											
100 +	\$8.79																																											
PRICE																																												
1-24	\$11.70																																											
25-49	\$10.88																																											
50-99	\$10.06																																											
100 +	\$9.36																																											

Adapters

See Our Website For Real-Time Stock Availability!













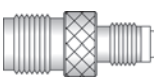
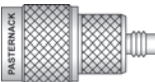
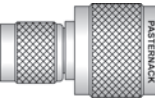
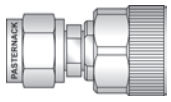
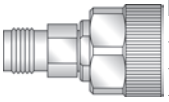

# ADAPTERS

See Adapter Locator on Pages 140-145 or the Adapter Matrix on Pages 138-139

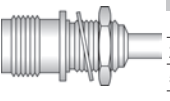
See Page 246 for Mounting Holes

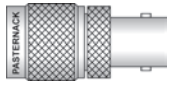
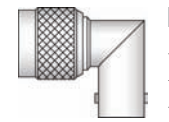
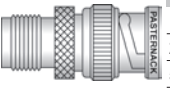
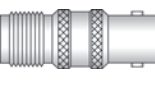
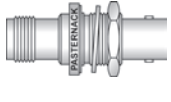
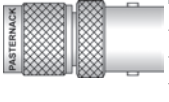
Adapters

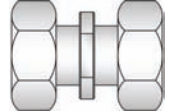
See Our Website For Real-Time Stock Availability!

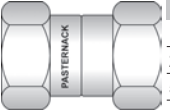









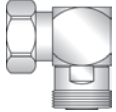

	A	B	C	D																																								
1	 <table border="1"> <thead> <tr> <th colspan="2">PRICE</th> </tr> </thead> <tbody> <tr> <td>1-24</td> <td>\$11.70</td> </tr> <tr> <td>25-49</td> <td>\$10.88</td> </tr> <tr> <td>50-99</td> <td>\$10.06</td> </tr> <tr> <td>100 +</td> <td>\$9.36</td> </tr> </tbody> </table> <p><b>Model No: PE9700</b> TNC Male To FME Plug Right Angle</p>	PRICE		1-24	\$11.70	25-49	\$10.88	50-99	\$10.06	100 +	\$9.36	 <table border="1"> <thead> <tr> <th colspan="2">PRICE</th> </tr> </thead> <tbody> <tr> <td>1-24</td> <td>\$11.70</td> </tr> <tr> <td>25-49</td> <td>\$10.88</td> </tr> <tr> <td>50-99</td> <td>\$10.06</td> </tr> <tr> <td>100 +</td> <td>\$9.36</td> </tr> </tbody> </table> <p><b>Model No: PE9713</b> TNC Male To FME Jack</p>	PRICE		1-24	\$11.70	25-49	\$10.88	50-99	\$10.06	100 +	\$9.36	 <table border="1"> <thead> <tr> <th colspan="2">PRICE</th> </tr> </thead> <tbody> <tr> <td>1-24</td> <td>\$11.70</td> </tr> <tr> <td>25-49</td> <td>\$10.88</td> </tr> <tr> <td>50-99</td> <td>\$10.06</td> </tr> <tr> <td>100 +</td> <td>\$9.36</td> </tr> </tbody> </table> <p><b>Model No: PE9714</b> TNC Female To FME Jack</p>	PRICE		1-24	\$11.70	25-49	\$10.88	50-99	\$10.06	100 +	\$9.36	 <table border="1"> <thead> <tr> <th colspan="2">PRICE</th> </tr> </thead> <tbody> <tr> <td>1-24</td> <td>\$42.96</td> </tr> <tr> <td>25-49</td> <td>\$39.95</td> </tr> <tr> <td>50-99</td> <td>\$36.95</td> </tr> <tr> <td>100 +</td> <td>\$34.37</td> </tr> </tbody> </table> <p><b>Model No: PE9226</b> TNC Male To SMC Jack</p>	PRICE		1-24	\$42.96	25-49	\$39.95	50-99	\$36.95	100 +	\$34.37
PRICE																																												
1-24	\$11.70																																											
25-49	\$10.88																																											
50-99	\$10.06																																											
100 +	\$9.36																																											
PRICE																																												
1-24	\$11.70																																											
25-49	\$10.88																																											
50-99	\$10.06																																											
100 +	\$9.36																																											
PRICE																																												
1-24	\$11.70																																											
25-49	\$10.88																																											
50-99	\$10.06																																											
100 +	\$9.36																																											
PRICE																																												
1-24	\$42.96																																											
25-49	\$39.95																																											
50-99	\$36.95																																											
100 +	\$34.37																																											
2	 <table border="1"> <thead> <tr> <th colspan="2">PRICE</th> </tr> </thead> <tbody> <tr> <td>1-24</td> <td>\$59.02</td> </tr> <tr> <td>25-49</td> <td>\$54.89</td> </tr> <tr> <td>50-99</td> <td>\$50.76</td> </tr> <tr> <td>100 +</td> <td>\$47.22</td> </tr> </tbody> </table> <p><b>Model No: PE9563</b> TNC Male To HN Male</p>	PRICE		1-24	\$59.02	25-49	\$54.89	50-99	\$50.76	100 +	\$47.22	 <table border="1"> <thead> <tr> <th colspan="2">PRICE</th> </tr> </thead> <tbody> <tr> <td>1-24</td> <td>\$235.44</td> </tr> <tr> <td>25-49</td> <td>\$218.96</td> </tr> <tr> <td>50-99</td> <td>\$202.48</td> </tr> <tr> <td>100 +</td> <td>\$188.35</td> </tr> </tbody> </table> <p><b>PRECISION</b> <b>Model No: PE9219</b> TNC Male To 7mm Max VSWR 1.15:1 @ 18 GHz</p>	PRICE		1-24	\$235.44	25-49	\$218.96	50-99	\$202.48	100 +	\$188.35	 <table border="1"> <thead> <tr> <th colspan="2">PRICE</th> </tr> </thead> <tbody> <tr> <td>1-24</td> <td>\$235.44</td> </tr> <tr> <td>25-49</td> <td>\$218.96</td> </tr> <tr> <td>50-99</td> <td>\$202.48</td> </tr> <tr> <td>100 +</td> <td>\$188.35</td> </tr> </tbody> </table> <p><b>PRECISION</b> <b>Model No: PE9218</b> TNC Female To 7mm Max VSWR 1.15:1 @ 18 GHz</p>	PRICE		1-24	\$235.44	25-49	\$218.96	50-99	\$202.48	100 +	\$188.35	 <table border="1"> <thead> <tr> <th colspan="2">PRICE</th> </tr> </thead> <tbody> <tr> <td>1-24</td> <td>\$58.87</td> </tr> <tr> <td>25-49</td> <td>\$54.75</td> </tr> <tr> <td>50-99</td> <td>\$50.63</td> </tr> <tr> <td>100 +</td> <td>\$47.10</td> </tr> </tbody> </table> <p><b>Model No: PE9543</b> TNC Male To MCX Plug</p>	PRICE		1-24	\$58.87	25-49	\$54.75	50-99	\$50.63	100 +	\$47.10
PRICE																																												
1-24	\$59.02																																											
25-49	\$54.89																																											
50-99	\$50.76																																											
100 +	\$47.22																																											
PRICE																																												
1-24	\$235.44																																											
25-49	\$218.96																																											
50-99	\$202.48																																											
100 +	\$188.35																																											
PRICE																																												
1-24	\$235.44																																											
25-49	\$218.96																																											
50-99	\$202.48																																											
100 +	\$188.35																																											
PRICE																																												
1-24	\$58.87																																											
25-49	\$54.75																																											
50-99	\$50.63																																											
100 +	\$47.10																																											
3	 <table border="1"> <thead> <tr> <th colspan="2">PRICE</th> </tr> </thead> <tbody> <tr> <td>1-24</td> <td>\$51.32</td> </tr> <tr> <td>25-49</td> <td>\$47.73</td> </tr> <tr> <td>50-99</td> <td>\$44.14</td> </tr> <tr> <td>100 +</td> <td>\$41.06</td> </tr> </tbody> </table> <p><b>Model No: PE9542</b> TNC Male To MCX Jack</p>	PRICE		1-24	\$51.32	25-49	\$47.73	50-99	\$44.14	100 +	\$41.06	 <table border="1"> <thead> <tr> <th colspan="2">PRICE</th> </tr> </thead> <tbody> <tr> <td>1-24</td> <td>\$58.87</td> </tr> <tr> <td>25-49</td> <td>\$54.75</td> </tr> <tr> <td>50-99</td> <td>\$50.63</td> </tr> <tr> <td>100 +</td> <td>\$47.10</td> </tr> </tbody> </table> <p><b>Model No: PE9545</b> TNC Female To MCX Plug</p>	PRICE		1-24	\$58.87	25-49	\$54.75	50-99	\$50.63	100 +	\$47.10	 <table border="1"> <thead> <tr> <th colspan="2">PRICE</th> </tr> </thead> <tbody> <tr> <td>1-24</td> <td>\$58.87</td> </tr> <tr> <td>25-49</td> <td>\$54.75</td> </tr> <tr> <td>50-99</td> <td>\$50.63</td> </tr> <tr> <td>100 +</td> <td>\$47.10</td> </tr> </tbody> </table> <p><b>Model No: PE9544</b> TNC Female To MCX Jack</p>	PRICE		1-24	\$58.87	25-49	\$54.75	50-99	\$50.63	100 +	\$47.10	 <table border="1"> <thead> <tr> <th colspan="2">PRICE</th> </tr> </thead> <tbody> <tr> <td>1-24</td> <td>\$67.03</td> </tr> <tr> <td>25-49</td> <td>\$62.34</td> </tr> <tr> <td>50-99</td> <td>\$57.65</td> </tr> <tr> <td>100 +</td> <td>\$53.62</td> </tr> </tbody> </table> <p><b>Model No: PE9521</b> TNC Female To MCX Jack Bulkhead Mounting Hole B04</p>	PRICE		1-24	\$67.03	25-49	\$62.34	50-99	\$57.65	100 +	\$53.62
PRICE																																												
1-24	\$51.32																																											
25-49	\$47.73																																											
50-99	\$44.14																																											
100 +	\$41.06																																											
PRICE																																												
1-24	\$58.87																																											
25-49	\$54.75																																											
50-99	\$50.63																																											
100 +	\$47.10																																											
PRICE																																												
1-24	\$58.87																																											
25-49	\$54.75																																											
50-99	\$50.63																																											
100 +	\$47.10																																											
PRICE																																												
1-24	\$67.03																																											
25-49	\$62.34																																											
50-99	\$57.65																																											
100 +	\$53.62																																											
4	 <table border="1"> <thead> <tr> <th colspan="2">PRICE</th> </tr> </thead> <tbody> <tr> <td>1-24</td> <td>\$21.68</td> </tr> <tr> <td>25-49</td> <td>\$20.16</td> </tr> <tr> <td>50-99</td> <td>\$18.64</td> </tr> <tr> <td>100 +</td> <td>\$17.34</td> </tr> </tbody> </table> <p><b>Model No: PE9110</b> TNC Male To BNC Male</p>	PRICE		1-24	\$21.68	25-49	\$20.16	50-99	\$18.64	100 +	\$17.34	 <table border="1"> <thead> <tr> <th colspan="2">PRICE</th> </tr> </thead> <tbody> <tr> <td>1-24</td> <td>\$20.09</td> </tr> <tr> <td>25-49</td> <td>\$18.68</td> </tr> <tr> <td>50-99</td> <td>\$17.28</td> </tr> <tr> <td>100 +</td> <td>\$16.07</td> </tr> </tbody> </table> <p><b>Model No: PE9088</b> TNC Male To BNC Female</p>	PRICE		1-24	\$20.09	25-49	\$18.68	50-99	\$17.28	100 +	\$16.07	 <table border="1"> <thead> <tr> <th colspan="2">PRICE</th> </tr> </thead> <tbody> <tr> <td>1-24</td> <td>\$48.08</td> </tr> <tr> <td>25-49</td> <td>\$44.71</td> </tr> <tr> <td>50-99</td> <td>\$41.35</td> </tr> <tr> <td>100 +</td> <td>\$38.46</td> </tr> </tbody> </table> <p><b>Model No: PE9783</b> TNC Male To BNC Female Right Angle</p>	PRICE		1-24	\$48.08	25-49	\$44.71	50-99	\$41.35	100 +	\$38.46	 <table border="1"> <thead> <tr> <th colspan="2">PRICE</th> </tr> </thead> <tbody> <tr> <td>1-24</td> <td>\$21.45</td> </tr> <tr> <td>25-49</td> <td>\$19.95</td> </tr> <tr> <td>50-99</td> <td>\$18.45</td> </tr> <tr> <td>100 +</td> <td>\$17.16</td> </tr> </tbody> </table> <p><b>Model No: PE9098</b> TNC Female To BNC Male</p>	PRICE		1-24	\$21.45	25-49	\$19.95	50-99	\$18.45	100 +	\$17.16
PRICE																																												
1-24	\$21.68																																											
25-49	\$20.16																																											
50-99	\$18.64																																											
100 +	\$17.34																																											
PRICE																																												
1-24	\$20.09																																											
25-49	\$18.68																																											
50-99	\$17.28																																											
100 +	\$16.07																																											
PRICE																																												
1-24	\$48.08																																											
25-49	\$44.71																																											
50-99	\$41.35																																											
100 +	\$38.46																																											
PRICE																																												
1-24	\$21.45																																											
25-49	\$19.95																																											
50-99	\$18.45																																											
100 +	\$17.16																																											
5	 <table border="1"> <thead> <tr> <th colspan="2">PRICE</th> </tr> </thead> <tbody> <tr> <td>1-24</td> <td>\$18.10</td> </tr> <tr> <td>25-49</td> <td>\$16.83</td> </tr> <tr> <td>50-99</td> <td>\$15.57</td> </tr> <tr> <td>100 +</td> <td>\$14.48</td> </tr> </tbody> </table> <p><b>Model No: PE9097</b> TNC Female To BNC Female</p>	PRICE		1-24	\$18.10	25-49	\$16.83	50-99	\$15.57	100 +	\$14.48	 <table border="1"> <thead> <tr> <th colspan="2">PRICE</th> </tr> </thead> <tbody> <tr> <td>1-24</td> <td>\$33.49</td> </tr> <tr> <td>25-49</td> <td>\$31.15</td> </tr> <tr> <td>50-99</td> <td>\$28.80</td> </tr> <tr> <td>100 +</td> <td>\$26.79</td> </tr> </tbody> </table> <p><b>Model No: PE9483</b> TNC Female To BNC Female Bulkhead, Hermetically Sealed Mounting Hole B06</p>	PRICE		1-24	\$33.49	25-49	\$31.15	50-99	\$28.80	100 +	\$26.79	 <table border="1"> <thead> <tr> <th colspan="2">PRICE</th> </tr> </thead> <tbody> <tr> <td>1-24</td> <td>\$59.02</td> </tr> <tr> <td>25-49</td> <td>\$54.89</td> </tr> <tr> <td>50-99</td> <td>\$50.76</td> </tr> <tr> <td>100 +</td> <td>\$47.22</td> </tr> </tbody> </table> <p><b>Model No: PE9562</b> TNC Male To C Female</p>	PRICE		1-24	\$59.02	25-49	\$54.89	50-99	\$50.76	100 +	\$47.22	 <table border="1"> <thead> <tr> <th colspan="2">PRICE</th> </tr> </thead> <tbody> <tr> <td>1-24</td> <td>\$79.70</td> </tr> <tr> <td>25-49</td> <td>\$74.12</td> </tr> <tr> <td>50-99</td> <td>\$68.54</td> </tr> <tr> <td>100 +</td> <td>\$63.76</td> </tr> </tbody> </table> <p><b>Model No: PE9564</b> TNC Female To C Male</p>	PRICE		1-24	\$79.70	25-49	\$74.12	50-99	\$68.54	100 +	\$63.76
PRICE																																												
1-24	\$18.10																																											
25-49	\$16.83																																											
50-99	\$15.57																																											
100 +	\$14.48																																											
PRICE																																												
1-24	\$33.49																																											
25-49	\$31.15																																											
50-99	\$28.80																																											
100 +	\$26.79																																											
PRICE																																												
1-24	\$59.02																																											
25-49	\$54.89																																											
50-99	\$50.76																																											
100 +	\$47.22																																											
PRICE																																												
1-24	\$79.70																																											
25-49	\$74.12																																											
50-99	\$68.54																																											
100 +	\$63.76																																											
6	<div style="background-color: black; color: white; padding: 10px; text-align: center;"> <p><b>7/16 DIN In-Series</b></p> <p>→</p> </div>	 <table border="1"> <thead> <tr> <th colspan="2">PRICE</th> </tr> </thead> <tbody> <tr> <td>1-24</td> <td>\$81.00</td> </tr> <tr> <td>25-49</td> <td>\$75.33</td> </tr> <tr> <td>50-99</td> <td>\$69.66</td> </tr> <tr> <td>100 +</td> <td>\$64.80</td> </tr> </tbody> </table> <p><b>PRECISION NEW</b> <b>Model No: PE91039</b> 7/16 Male To 7/16 Male Low PIM, Low VSWR</p>	PRICE		1-24	\$81.00	25-49	\$75.33	50-99	\$69.66	100 +	\$64.80	 <table border="1"> <thead> <tr> <th colspan="2">PRICE</th> </tr> </thead> <tbody> <tr> <td>1-24</td> <td>\$72.00</td> </tr> <tr> <td>25-49</td> <td>\$66.96</td> </tr> <tr> <td>50-99</td> <td>\$61.92</td> </tr> <tr> <td>100 +</td> <td>\$57.60</td> </tr> </tbody> </table> <p><b>PRECISION NEW</b> <b>Model No: PE91028</b> 7/16 Male To 7/16 Female Low PIM, Low VSWR</p>	PRICE		1-24	\$72.00	25-49	\$66.96	50-99	\$61.92	100 +	\$57.60	 <table border="1"> <thead> <tr> <th colspan="2">PRICE</th> </tr> </thead> <tbody> <tr> <td>1-24</td> <td>\$92.56</td> </tr> <tr> <td>25-49</td> <td>\$86.08</td> </tr> <tr> <td>50-99</td> <td>\$79.60</td> </tr> <tr> <td>100 +</td> <td>\$74.05</td> </tr> </tbody> </table> <p><b>Model No: PE9555</b> 7/16 Male To 7/16 Male</p>	PRICE		1-24	\$92.56	25-49	\$86.08	50-99	\$79.60	100 +	\$74.05										
PRICE																																												
1-24	\$81.00																																											
25-49	\$75.33																																											
50-99	\$69.66																																											
100 +	\$64.80																																											
PRICE																																												
1-24	\$72.00																																											
25-49	\$66.96																																											
50-99	\$61.92																																											
100 +	\$57.60																																											
PRICE																																												
1-24	\$92.56																																											
25-49	\$86.08																																											
50-99	\$79.60																																											
100 +	\$74.05																																											

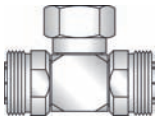
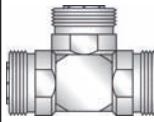

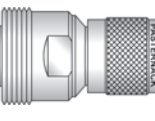
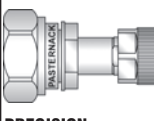
# ADAPTERS

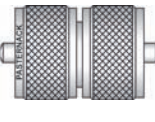
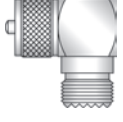
See Adapter Locator on Pages 140-145 or the Adapter Matrix on Pages 138-139

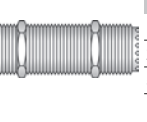
See Page 246 for Mounting Holes

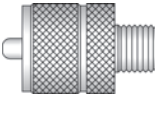
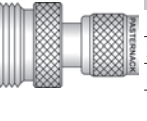
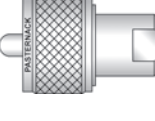
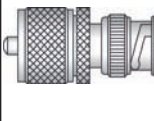
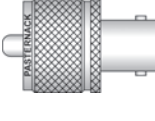
	A	B	C	D																																								
1	 <table border="1"> <thead> <tr> <th colspan="2">PRICE</th> </tr> </thead> <tbody> <tr> <td>1-24</td> <td>\$140.29</td> </tr> <tr> <td>25-49</td> <td>\$130.47</td> </tr> <tr> <td>50-99</td> <td>\$120.65</td> </tr> <tr> <td>100 +</td> <td>\$112.23</td> </tr> </tbody> </table> <p><b>Model No: PE9410</b> 7/16 Male To 7/16 Female Right Angle</p>	PRICE		1-24	\$140.29	25-49	\$130.47	50-99	\$120.65	100 +	\$112.23	 <table border="1"> <thead> <tr> <th colspan="2">PRICE</th> </tr> </thead> <tbody> <tr> <td>1-24</td> <td>\$72.00</td> </tr> <tr> <td>25-49</td> <td>\$66.96</td> </tr> <tr> <td>50-99</td> <td>\$61.92</td> </tr> <tr> <td>100 +</td> <td>\$57.60</td> </tr> </tbody> </table> <p><b>PRECISION NEW</b> <b>Model No: PE91029</b> 7/16 Female To 7/16 Female Low PIM, Low VSWR</p>	PRICE		1-24	\$72.00	25-49	\$66.96	50-99	\$61.92	100 +	\$57.60	 <table border="1"> <thead> <tr> <th colspan="2">PRICE</th> </tr> </thead> <tbody> <tr> <td>1-24</td> <td>\$83.39</td> </tr> <tr> <td>25-49</td> <td>\$77.55</td> </tr> <tr> <td>50-99</td> <td>\$71.72</td> </tr> <tr> <td>100 +</td> <td>\$66.71</td> </tr> </tbody> </table> <p><b>Model No: PE9409</b> 7/16 Female To 7/16 Female</p>	PRICE		1-24	\$83.39	25-49	\$77.55	50-99	\$71.72	100 +	\$66.71	 <table border="1"> <thead> <tr> <th colspan="2">PRICE</th> </tr> </thead> <tbody> <tr> <td>1-24</td> <td>\$102.00</td> </tr> <tr> <td>25-49</td> <td>\$94.86</td> </tr> <tr> <td>50-99</td> <td>\$87.72</td> </tr> <tr> <td>100 +</td> <td>\$81.60</td> </tr> </tbody> </table> <p><b>PRECISION NEW</b> <b>Model No: PE91038</b> 7/16 Female To 7/16 Female Bulkhead Low PIM, Low VSWR</p>	PRICE		1-24	\$102.00	25-49	\$94.86	50-99	\$87.72	100 +	\$81.60
	PRICE																																											
1-24	\$140.29																																											
25-49	\$130.47																																											
50-99	\$120.65																																											
100 +	\$112.23																																											
PRICE																																												
1-24	\$72.00																																											
25-49	\$66.96																																											
50-99	\$61.92																																											
100 +	\$57.60																																											
PRICE																																												
1-24	\$83.39																																											
25-49	\$77.55																																											
50-99	\$71.72																																											
100 +	\$66.71																																											
PRICE																																												
1-24	\$102.00																																											
25-49	\$94.86																																											
50-99	\$87.72																																											
100 +	\$81.60																																											
2	 <table border="1"> <thead> <tr> <th colspan="2">PRICE</th> </tr> </thead> <tbody> <tr> <td>1-24</td> <td>\$194.25</td> </tr> <tr> <td>25-49</td> <td>\$180.65</td> </tr> <tr> <td>50-99</td> <td>\$167.06</td> </tr> <tr> <td>100 +</td> <td>\$155.40</td> </tr> </tbody> </table> <p><b>Model No: PE9414</b> 7/16 Female To 7/16 Female Bulkhead</p>	PRICE		1-24	\$194.25	25-49	\$180.65	50-99	\$167.06	100 +	\$155.40	 <table border="1"> <thead> <tr> <th colspan="2">PRICE</th> </tr> </thead> <tbody> <tr> <td>1-24</td> <td>\$164.81</td> </tr> <tr> <td>25-49</td> <td>\$153.27</td> </tr> <tr> <td>50-99</td> <td>\$141.74</td> </tr> <tr> <td>100 +</td> <td>\$131.85</td> </tr> </tbody> </table> <p><b>Model No: PE9557</b> 7/16 "T" Female-Male-Female</p>	PRICE		1-24	\$164.81	25-49	\$153.27	50-99	\$141.74	100 +	\$131.85	 <table border="1"> <thead> <tr> <th colspan="2">PRICE</th> </tr> </thead> <tbody> <tr> <td>1-24</td> <td>\$164.81</td> </tr> <tr> <td>25-49</td> <td>\$153.27</td> </tr> <tr> <td>50-99</td> <td>\$141.74</td> </tr> <tr> <td>100 +</td> <td>\$131.85</td> </tr> </tbody> </table> <p><b>Model No: PE9556</b> 7/16 "T" Female-Female-Female</p>	PRICE		1-24	\$164.81	25-49	\$153.27	50-99	\$141.74	100 +	\$131.85	<div style="background-color: black; color: white; padding: 20px; text-align: center;"> <h2>7/16 DIN Between-Series</h2> <p>→</p> </div>										
	PRICE																																											
1-24	\$194.25																																											
25-49	\$180.65																																											
50-99	\$167.06																																											
100 +	\$155.40																																											
PRICE																																												
1-24	\$164.81																																											
25-49	\$153.27																																											
50-99	\$141.74																																											
100 +	\$131.85																																											
PRICE																																												
1-24	\$164.81																																											
25-49	\$153.27																																											
50-99	\$141.74																																											
100 +	\$131.85																																											
3	 <table border="1"> <thead> <tr> <th colspan="2">PRICE</th> </tr> </thead> <tbody> <tr> <td>1-24</td> <td>\$115.82</td> </tr> <tr> <td>25-49</td> <td>\$107.71</td> </tr> <tr> <td>50-99</td> <td>\$99.61</td> </tr> <tr> <td>100 +</td> <td>\$92.66</td> </tr> </tbody> </table> <p><b>Model No: PE9558</b> 7/16 Male To HN Female</p>	PRICE		1-24	\$115.82	25-49	\$107.71	50-99	\$99.61	100 +	\$92.66	 <table border="1"> <thead> <tr> <th colspan="2">PRICE</th> </tr> </thead> <tbody> <tr> <td>1-24</td> <td>\$115.67</td> </tr> <tr> <td>25-49</td> <td>\$107.57</td> </tr> <tr> <td>50-99</td> <td>\$99.48</td> </tr> <tr> <td>100 +</td> <td>\$92.54</td> </tr> </tbody> </table> <p><b>Model No: PE9559</b> 7/16 Female To HN Male</p>	PRICE		1-24	\$115.67	25-49	\$107.57	50-99	\$99.48	100 +	\$92.54	 <table border="1"> <thead> <tr> <th colspan="2">PRICE</th> </tr> </thead> <tbody> <tr> <td>1-24</td> <td>\$306.12</td> </tr> <tr> <td>25-49</td> <td>\$284.69</td> </tr> <tr> <td>50-99</td> <td>\$263.26</td> </tr> <tr> <td>100 +</td> <td>\$244.90</td> </tr> </tbody> </table> <p><b>PRECISION</b> <b>Model No: PE9509</b> 7/16 Male To 7mm Max VSWR 1.35:1 @ 7 GHz</p>	PRICE		1-24	\$306.12	25-49	\$284.69	50-99	\$263.26	100 +	\$244.90	 <table border="1"> <thead> <tr> <th colspan="2">PRICE</th> </tr> </thead> <tbody> <tr> <td>1-24</td> <td>\$353.24</td> </tr> <tr> <td>25-49</td> <td>\$328.51</td> </tr> <tr> <td>50-99</td> <td>\$303.79</td> </tr> <tr> <td>100 +</td> <td>\$282.59</td> </tr> </tbody> </table> <p><b>PRECISION</b> <b>Model No: PE9510</b> 7/16 Female To 7mm Max VSWR 1.35:1 @ 7 GHz</p>	PRICE		1-24	\$353.24	25-49	\$328.51	50-99	\$303.79	100 +	\$282.59
	PRICE																																											
1-24	\$115.82																																											
25-49	\$107.71																																											
50-99	\$99.61																																											
100 +	\$92.66																																											
PRICE																																												
1-24	\$115.67																																											
25-49	\$107.57																																											
50-99	\$99.48																																											
100 +	\$92.54																																											
PRICE																																												
1-24	\$306.12																																											
25-49	\$284.69																																											
50-99	\$263.26																																											
100 +	\$244.90																																											
PRICE																																												
1-24	\$353.24																																											
25-49	\$328.51																																											
50-99	\$303.79																																											
100 +	\$282.59																																											
4	<div style="background-color: black; color: white; padding: 20px; text-align: center;"> <h2>UHF In-Series</h2> <p>→</p> </div>	 <table border="1"> <thead> <tr> <th colspan="2">PRICE</th> </tr> </thead> <tbody> <tr> <td>1-24</td> <td>\$9.91</td> </tr> <tr> <td>25-49</td> <td>\$9.22</td> </tr> <tr> <td>50-99</td> <td>\$8.52</td> </tr> <tr> <td>100 +</td> <td>\$7.93</td> </tr> </tbody> </table> <p><b>Model No: PE9096</b> UHF Male To UHF Male</p>	PRICE		1-24	\$9.91	25-49	\$9.22	50-99	\$8.52	100 +	\$7.93	 <table border="1"> <thead> <tr> <th colspan="2">PRICE</th> </tr> </thead> <tbody> <tr> <td>1-24</td> <td>\$14.74</td> </tr> <tr> <td>25-49</td> <td>\$13.71</td> </tr> <tr> <td>50-99</td> <td>\$12.68</td> </tr> <tr> <td>100 +</td> <td>\$11.79</td> </tr> </tbody> </table> <p><b>Model No: PE9209</b> UHF Male To UHF Female Right Angle</p>	PRICE		1-24	\$14.74	25-49	\$13.71	50-99	\$12.68	100 +	\$11.79	 <table border="1"> <thead> <tr> <th colspan="2">PRICE</th> </tr> </thead> <tbody> <tr> <td>1-24</td> <td>\$8.76</td> </tr> <tr> <td>25-49</td> <td>\$8.15</td> </tr> <tr> <td>50-99</td> <td>\$7.53</td> </tr> <tr> <td>100 +</td> <td>\$7.01</td> </tr> </tbody> </table> <p><b>Model No: PE9094</b> UHF Female To UHF Female</p>	PRICE		1-24	\$8.76	25-49	\$8.15	50-99	\$7.53	100 +	\$7.01										
		PRICE																																										
1-24	\$9.91																																											
25-49	\$9.22																																											
50-99	\$8.52																																											
100 +	\$7.93																																											
PRICE																																												
1-24	\$14.74																																											
25-49	\$13.71																																											
50-99	\$12.68																																											
100 +	\$11.79																																											
PRICE																																												
1-24	\$8.76																																											
25-49	\$8.15																																											
50-99	\$7.53																																											
100 +	\$7.01																																											
5	 <table border="1"> <thead> <tr> <th colspan="2">PRICE</th> </tr> </thead> <tbody> <tr> <td>1-24</td> <td>\$32.53</td> </tr> <tr> <td>25-49</td> <td>\$30.25</td> </tr> <tr> <td>50-99</td> <td>\$27.98</td> </tr> <tr> <td>100 +</td> <td>\$26.02</td> </tr> </tbody> </table> <p><b>Model No: PE9114</b> UHF Female To UHF Female Bulkhead Mounting Hole F03</p>	PRICE		1-24	\$32.53	25-49	\$30.25	50-99	\$27.98	100 +	\$26.02	 <table border="1"> <thead> <tr> <th colspan="2">PRICE</th> </tr> </thead> <tbody> <tr> <td>1-24</td> <td>\$14.69</td> </tr> <tr> <td>25-49</td> <td>\$13.66</td> </tr> <tr> <td>50-99</td> <td>\$12.63</td> </tr> <tr> <td>100 +</td> <td>\$11.75</td> </tr> </tbody> </table> <p><b>Model No: PE9095</b> UHF "T" Female-Male-Female</p>	PRICE		1-24	\$14.69	25-49	\$13.66	50-99	\$12.63	100 +	\$11.75	<div style="background-color: black; color: white; padding: 20px; text-align: center;"> <h2>UHF Between-Series</h2> <p>→</p> </div>	 <table border="1"> <thead> <tr> <th colspan="2">PRICE</th> </tr> </thead> <tbody> <tr> <td>1-24</td> <td>\$10.99</td> </tr> <tr> <td>25-49</td> <td>\$10.22</td> </tr> <tr> <td>50-99</td> <td>\$9.45</td> </tr> <tr> <td>100 +</td> <td>\$8.79</td> </tr> </tbody> </table> <p><b>Model No: PE9348</b> UHF Male To Mini-UHF Female</p>	PRICE		1-24	\$10.99	25-49	\$10.22	50-99	\$9.45	100 +	\$8.79										
	PRICE																																											
1-24	\$32.53																																											
25-49	\$30.25																																											
50-99	\$27.98																																											
100 +	\$26.02																																											
PRICE																																												
1-24	\$14.69																																											
25-49	\$13.66																																											
50-99	\$12.63																																											
100 +	\$11.75																																											
PRICE																																												
1-24	\$10.99																																											
25-49	\$10.22																																											
50-99	\$9.45																																											
100 +	\$8.79																																											
6	 <table border="1"> <thead> <tr> <th colspan="2">PRICE</th> </tr> </thead> <tbody> <tr> <td>1-24</td> <td>\$11.75</td> </tr> <tr> <td>25-49</td> <td>\$10.93</td> </tr> <tr> <td>50-99</td> <td>\$10.11</td> </tr> <tr> <td>100 +</td> <td>\$9.40</td> </tr> </tbody> </table> <p><b>Model No: PE9344</b> UHF Female To Mini-UHF Male</p>	PRICE		1-24	\$11.75	25-49	\$10.93	50-99	\$10.11	100 +	\$9.40	 <table border="1"> <thead> <tr> <th colspan="2">PRICE</th> </tr> </thead> <tbody> <tr> <td>1-24</td> <td>\$11.70</td> </tr> <tr> <td>25-49</td> <td>\$10.88</td> </tr> <tr> <td>50-99</td> <td>\$10.06</td> </tr> <tr> <td>100 +</td> <td>\$9.36</td> </tr> </tbody> </table> <p><b>Model No: PE9701</b> UHF Male To FME Plug</p>	PRICE		1-24	\$11.70	25-49	\$10.88	50-99	\$10.06	100 +	\$9.36	 <table border="1"> <thead> <tr> <th colspan="2">PRICE</th> </tr> </thead> <tbody> <tr> <td>1-24</td> <td>\$18.34</td> </tr> <tr> <td>25-49</td> <td>\$17.06</td> </tr> <tr> <td>50-99</td> <td>\$15.77</td> </tr> <tr> <td>100 +</td> <td>\$14.67</td> </tr> </tbody> </table> <p><b>Model No: PE9201</b> UHF Male To BNC Male</p>	PRICE		1-24	\$18.34	25-49	\$17.06	50-99	\$15.77	100 +	\$14.67	 <table border="1"> <thead> <tr> <th colspan="2">PRICE</th> </tr> </thead> <tbody> <tr> <td>1-24</td> <td>\$11.49</td> </tr> <tr> <td>25-49</td> <td>\$10.69</td> </tr> <tr> <td>50-99</td> <td>\$9.88</td> </tr> <tr> <td>100 +</td> <td>\$9.19</td> </tr> </tbody> </table> <p><b>Model No: PE9004</b> UHF Male To BNC Female</p>	PRICE		1-24	\$11.49	25-49	\$10.69	50-99	\$9.88	100 +	\$9.19
	PRICE																																											
1-24	\$11.75																																											
25-49	\$10.93																																											
50-99	\$10.11																																											
100 +	\$9.40																																											
PRICE																																												
1-24	\$11.70																																											
25-49	\$10.88																																											
50-99	\$10.06																																											
100 +	\$9.36																																											
PRICE																																												
1-24	\$18.34																																											
25-49	\$17.06																																											
50-99	\$15.77																																											
100 +	\$14.67																																											
PRICE																																												
1-24	\$11.49																																											
25-49	\$10.69																																											
50-99	\$9.88																																											
100 +	\$9.19																																											

Adapters

See Our Website For Real-Time Stock Availability!



Free Freight Available  
via UPS Ground  
to USA & Canada



Real-Time Stock  
Levels & Pricing  
On Our Website



Toll-Free Technical  
Support  
(866) 727-8376



Same-Day Shipping,  
Even Custom  
Cable Assemblies







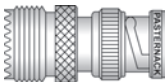

# ADAPTERS

See Adapter Locator on Pages 140-145 or the Adapter Matrix on Pages 138-139

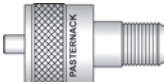
See Page 246 for Mounting Holes

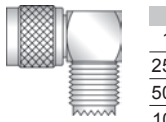
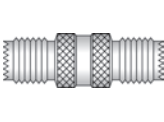
Adapters

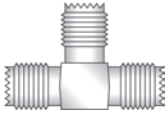
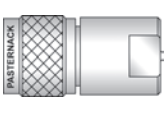
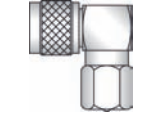
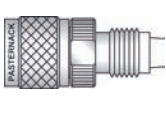
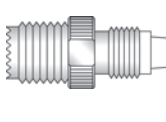
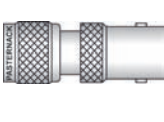
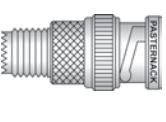
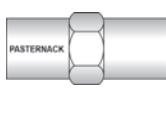
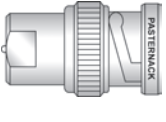
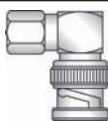
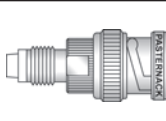









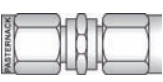

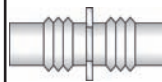

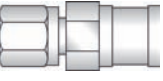
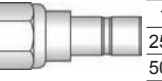
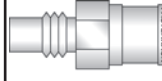
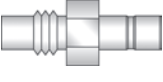

See Our Website For Real-Time Stock Availability!

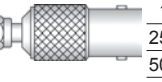
	A	B	C	D																																								
1	 <table border="1"> <thead> <tr> <th colspan="2">PRICE</th> </tr> </thead> <tbody> <tr> <td>1-24</td> <td>\$11.22</td> </tr> <tr> <td>25-49</td> <td>\$10.43</td> </tr> <tr> <td>50-99</td> <td>\$9.65</td> </tr> <tr> <td>100 +</td> <td>\$8.98</td> </tr> </tbody> </table> <p><b>Model No: PE9107</b> UHF Female To BNC Male</p>	PRICE		1-24	\$11.22	25-49	\$10.43	50-99	\$9.65	100 +	\$8.98	 <table border="1"> <thead> <tr> <th colspan="2">PRICE</th> </tr> </thead> <tbody> <tr> <td>1-24</td> <td>\$15.66</td> </tr> <tr> <td>25-49</td> <td>\$14.56</td> </tr> <tr> <td>50-99</td> <td>\$13.47</td> </tr> <tr> <td>100 +</td> <td>\$12.53</td> </tr> </tbody> </table> <p><b>Model No: PE9421</b> UHF Female To BNC Female</p>	PRICE		1-24	\$15.66	25-49	\$14.56	50-99	\$13.47	100 +	\$12.53	 <table border="1"> <thead> <tr> <th colspan="2">PRICE</th> </tr> </thead> <tbody> <tr> <td>1-24</td> <td>\$23.36</td> </tr> <tr> <td>25-49</td> <td>\$21.72</td> </tr> <tr> <td>50-99</td> <td>\$20.09</td> </tr> <tr> <td>100 +</td> <td>\$18.69</td> </tr> </tbody> </table> <p><b>Model No: PE9165</b> UHF Male To F Female</p>	PRICE		1-24	\$23.36	25-49	\$21.72	50-99	\$20.09	100 +	\$18.69	 <table border="1"> <thead> <tr> <th colspan="2">PRICE</th> </tr> </thead> <tbody> <tr> <td>1-24</td> <td>\$23.36</td> </tr> <tr> <td>25-49</td> <td>\$21.72</td> </tr> <tr> <td>50-99</td> <td>\$20.09</td> </tr> <tr> <td>100 +</td> <td>\$18.69</td> </tr> </tbody> </table> <p><b>Model No: PE9167</b> UHF Female To F Female</p>	PRICE		1-24	\$23.36	25-49	\$21.72	50-99	\$20.09	100 +	\$18.69
PRICE																																												
1-24	\$11.22																																											
25-49	\$10.43																																											
50-99	\$9.65																																											
100 +	\$8.98																																											
PRICE																																												
1-24	\$15.66																																											
25-49	\$14.56																																											
50-99	\$13.47																																											
100 +	\$12.53																																											
PRICE																																												
1-24	\$23.36																																											
25-49	\$21.72																																											
50-99	\$20.09																																											
100 +	\$18.69																																											
PRICE																																												
1-24	\$23.36																																											
25-49	\$21.72																																											
50-99	\$20.09																																											
100 +	\$18.69																																											
2	<p><b>Mini UHF In-Series</b></p> <p>→</p>	 <table border="1"> <thead> <tr> <th colspan="2">PRICE</th> </tr> </thead> <tbody> <tr> <td>1-24</td> <td>\$11.04</td> </tr> <tr> <td>25-49</td> <td>\$10.27</td> </tr> <tr> <td>50-99</td> <td>\$9.49</td> </tr> <tr> <td>100 +</td> <td>\$8.83</td> </tr> </tbody> </table> <p><b>Model No: PE9347</b> Mini UHF Male To Mini UHF Female Right Angle</p>	PRICE		1-24	\$11.04	25-49	\$10.27	50-99	\$9.49	100 +	\$8.83	 <table border="1"> <thead> <tr> <th colspan="2">PRICE</th> </tr> </thead> <tbody> <tr> <td>1-24</td> <td>\$10.99</td> </tr> <tr> <td>25-49</td> <td>\$10.22</td> </tr> <tr> <td>50-99</td> <td>\$9.45</td> </tr> <tr> <td>100 +</td> <td>\$8.79</td> </tr> </tbody> </table> <p><b>Model No: PE9343</b> Mini UHF Female To Mini UHF Female</p>	PRICE		1-24	\$10.99	25-49	\$10.22	50-99	\$9.45	100 +	\$8.79	 <table border="1"> <thead> <tr> <th colspan="2">PRICE</th> </tr> </thead> <tbody> <tr> <td>1-24</td> <td>\$9.73</td> </tr> <tr> <td>25-49</td> <td>\$9.05</td> </tr> <tr> <td>50-99</td> <td>\$8.37</td> </tr> <tr> <td>100 +</td> <td>\$7.78</td> </tr> </tbody> </table> <p><b>Model No: PE9065</b> Mini UHF "T" Female-Male-Female</p>	PRICE		1-24	\$9.73	25-49	\$9.05	50-99	\$8.37	100 +	\$7.78										
PRICE																																												
1-24	\$11.04																																											
25-49	\$10.27																																											
50-99	\$9.49																																											
100 +	\$8.83																																											
PRICE																																												
1-24	\$10.99																																											
25-49	\$10.22																																											
50-99	\$9.45																																											
100 +	\$8.79																																											
PRICE																																												
1-24	\$9.73																																											
25-49	\$9.05																																											
50-99	\$8.37																																											
100 +	\$7.78																																											
3	 <table border="1"> <thead> <tr> <th colspan="2">PRICE</th> </tr> </thead> <tbody> <tr> <td>1-24</td> <td>\$10.99</td> </tr> <tr> <td>25-49</td> <td>\$10.22</td> </tr> <tr> <td>50-99</td> <td>\$9.45</td> </tr> <tr> <td>100 +</td> <td>\$8.79</td> </tr> </tbody> </table> <p><b>Model No: PE9066</b> Mini UHF "T" Female-Female-Female</p>	PRICE		1-24	\$10.99	25-49	\$10.22	50-99	\$9.45	100 +	\$8.79	<p><b>Mini UHF Between-Series</b></p> <p>→</p>	 <table border="1"> <thead> <tr> <th colspan="2">PRICE</th> </tr> </thead> <tbody> <tr> <td>1-24</td> <td>\$11.70</td> </tr> <tr> <td>25-49</td> <td>\$10.88</td> </tr> <tr> <td>50-99</td> <td>\$10.06</td> </tr> <tr> <td>100 +</td> <td>\$9.36</td> </tr> </tbody> </table> <p><b>Model No: PE9705</b> Mini UHF Male To FME Plug</p>	PRICE		1-24	\$11.70	25-49	\$10.88	50-99	\$10.06	100 +	\$9.36	 <table border="1"> <thead> <tr> <th colspan="2">PRICE</th> </tr> </thead> <tbody> <tr> <td>1-24</td> <td>\$11.70</td> </tr> <tr> <td>25-49</td> <td>\$10.88</td> </tr> <tr> <td>50-99</td> <td>\$10.06</td> </tr> <tr> <td>100 +</td> <td>\$9.36</td> </tr> </tbody> </table> <p><b>Model No: PE9706</b> Mini UHF Male To FME Plug Right Angle</p>	PRICE		1-24	\$11.70	25-49	\$10.88	50-99	\$10.06	100 +	\$9.36										
PRICE																																												
1-24	\$10.99																																											
25-49	\$10.22																																											
50-99	\$9.45																																											
100 +	\$8.79																																											
PRICE																																												
1-24	\$11.70																																											
25-49	\$10.88																																											
50-99	\$10.06																																											
100 +	\$9.36																																											
PRICE																																												
1-24	\$11.70																																											
25-49	\$10.88																																											
50-99	\$10.06																																											
100 +	\$9.36																																											
4	 <table border="1"> <thead> <tr> <th colspan="2">PRICE</th> </tr> </thead> <tbody> <tr> <td>1-24</td> <td>\$11.70</td> </tr> <tr> <td>25-49</td> <td>\$10.88</td> </tr> <tr> <td>50-99</td> <td>\$10.06</td> </tr> <tr> <td>100 +</td> <td>\$9.36</td> </tr> </tbody> </table> <p><b>Model No: PE9709</b> Mini UHF Male To FME Jack</p>	PRICE		1-24	\$11.70	25-49	\$10.88	50-99	\$10.06	100 +	\$9.36	 <table border="1"> <thead> <tr> <th colspan="2">PRICE</th> </tr> </thead> <tbody> <tr> <td>1-24</td> <td>\$11.70</td> </tr> <tr> <td>25-49</td> <td>\$10.88</td> </tr> <tr> <td>50-99</td> <td>\$10.06</td> </tr> <tr> <td>100 +</td> <td>\$9.36</td> </tr> </tbody> </table> <p><b>Model No: PE9710</b> Mini UHF Female To FME Jack</p>	PRICE		1-24	\$11.70	25-49	\$10.88	50-99	\$10.06	100 +	\$9.36	 <table border="1"> <thead> <tr> <th colspan="2">PRICE</th> </tr> </thead> <tbody> <tr> <td>1-24</td> <td>\$11.22</td> </tr> <tr> <td>25-49</td> <td>\$10.43</td> </tr> <tr> <td>50-99</td> <td>\$9.65</td> </tr> <tr> <td>100 +</td> <td>\$8.98</td> </tr> </tbody> </table> <p><b>Model No: PE9342</b> Mini UHF Male To BNC Female</p>	PRICE		1-24	\$11.22	25-49	\$10.43	50-99	\$9.65	100 +	\$8.98	 <table border="1"> <thead> <tr> <th colspan="2">PRICE</th> </tr> </thead> <tbody> <tr> <td>1-24</td> <td>\$10.99</td> </tr> <tr> <td>25-49</td> <td>\$10.22</td> </tr> <tr> <td>50-99</td> <td>\$9.45</td> </tr> <tr> <td>100 +</td> <td>\$8.79</td> </tr> </tbody> </table> <p><b>Model No: PE9341</b> Mini UHF Female To BNC Male</p>	PRICE		1-24	\$10.99	25-49	\$10.22	50-99	\$9.45	100 +	\$8.79
PRICE																																												
1-24	\$11.70																																											
25-49	\$10.88																																											
50-99	\$10.06																																											
100 +	\$9.36																																											
PRICE																																												
1-24	\$11.70																																											
25-49	\$10.88																																											
50-99	\$10.06																																											
100 +	\$9.36																																											
PRICE																																												
1-24	\$11.22																																											
25-49	\$10.43																																											
50-99	\$9.65																																											
100 +	\$8.98																																											
PRICE																																												
1-24	\$10.99																																											
25-49	\$10.22																																											
50-99	\$9.45																																											
100 +	\$8.79																																											
5	<p><b>FME In-Series</b></p> <p>→</p>	 <table border="1"> <thead> <tr> <th colspan="2">PRICE</th> </tr> </thead> <tbody> <tr> <td>1-24</td> <td>\$11.70</td> </tr> <tr> <td>25-49</td> <td>\$10.88</td> </tr> <tr> <td>50-99</td> <td>\$10.06</td> </tr> <tr> <td>100 +</td> <td>\$9.36</td> </tr> </tbody> </table> <p><b>Model No: PE9696</b> FME Plug To FME Plug</p>	PRICE		1-24	\$11.70	25-49	\$10.88	50-99	\$10.06	100 +	\$9.36	<p><b>FME Between-Series</b></p> <p>→</p>	 <table border="1"> <thead> <tr> <th colspan="2">PRICE</th> </tr> </thead> <tbody> <tr> <td>1-24</td> <td>\$11.70</td> </tr> <tr> <td>25-49</td> <td>\$10.88</td> </tr> <tr> <td>50-99</td> <td>\$10.06</td> </tr> <tr> <td>100 +</td> <td>\$9.36</td> </tr> </tbody> </table> <p><b>Model No: PE9697</b> FME Plug To BNC Male</p>	PRICE		1-24	\$11.70	25-49	\$10.88	50-99	\$10.06	100 +	\$9.36																				
PRICE																																												
1-24	\$11.70																																											
25-49	\$10.88																																											
50-99	\$10.06																																											
100 +	\$9.36																																											
PRICE																																												
1-24	\$11.70																																											
25-49	\$10.88																																											
50-99	\$10.06																																											
100 +	\$9.36																																											
6	 <table border="1"> <thead> <tr> <th colspan="2">PRICE</th> </tr> </thead> <tbody> <tr> <td>1-24</td> <td>\$11.70</td> </tr> <tr> <td>25-49</td> <td>\$10.88</td> </tr> <tr> <td>50-99</td> <td>\$10.06</td> </tr> <tr> <td>100 +</td> <td>\$9.36</td> </tr> </tbody> </table> <p><b>Model No: PE9698</b> FME Plug To BNC Male Right Angle</p>	PRICE		1-24	\$11.70	25-49	\$10.88	50-99	\$10.06	100 +	\$9.36	 <table border="1"> <thead> <tr> <th colspan="2">PRICE</th> </tr> </thead> <tbody> <tr> <td>1-24</td> <td>\$11.70</td> </tr> <tr> <td>25-49</td> <td>\$10.88</td> </tr> <tr> <td>50-99</td> <td>\$10.06</td> </tr> <tr> <td>100 +</td> <td>\$9.36</td> </tr> </tbody> </table> <p><b>Model No: PE9711</b> FME Jack To BNC Male</p>	PRICE		1-24	\$11.70	25-49	\$10.88	50-99	\$10.06	100 +	\$9.36	 <table border="1"> <thead> <tr> <th colspan="2">PRICE</th> </tr> </thead> <tbody> <tr> <td>1-24</td> <td>\$12.92</td> </tr> <tr> <td>25-49</td> <td>\$12.02</td> </tr> <tr> <td>50-99</td> <td>\$11.11</td> </tr> <tr> <td>100 +</td> <td>\$10.34</td> </tr> </tbody> </table> <p><b>Model No: PE9712</b> FME Jack To BNC Female</p>	PRICE		1-24	\$12.92	25-49	\$12.02	50-99	\$11.11	100 +	\$10.34	<p><b>SMC In-Series</b></p> <p>→</p>										
PRICE																																												
1-24	\$11.70																																											
25-49	\$10.88																																											
50-99	\$10.06																																											
100 +	\$9.36																																											
PRICE																																												
1-24	\$11.70																																											
25-49	\$10.88																																											
50-99	\$10.06																																											
100 +	\$9.36																																											
PRICE																																												
1-24	\$12.92																																											
25-49	\$12.02																																											
50-99	\$11.11																																											
100 +	\$10.34																																											

# ADAPTERS

See Adapter Locator on Pages 140-145 or the Adapter Matrix on Pages 138-139

See Page 246 for Mounting Holes

	A	B	C	D																																								
1	 <table border="1"> <thead> <tr> <th colspan="2">PRICE</th> </tr> </thead> <tbody> <tr> <td>1-24</td> <td>\$20.87</td> </tr> <tr> <td>25-49</td> <td>\$19.41</td> </tr> <tr> <td>50-99</td> <td>\$17.95</td> </tr> <tr> <td>100 +</td> <td>\$16.70</td> </tr> </tbody> </table> <p><b>Model No: PE9117</b> SMC Plug To SMC Plug</p>	PRICE		1-24	\$20.87	25-49	\$19.41	50-99	\$17.95	100 +	\$16.70	 <table border="1"> <thead> <tr> <th colspan="2">PRICE</th> </tr> </thead> <tbody> <tr> <td>1-24</td> <td>\$38.45</td> </tr> <tr> <td>25-49</td> <td>\$35.76</td> </tr> <tr> <td>50-99</td> <td>\$33.07</td> </tr> <tr> <td>100 +</td> <td>\$30.76</td> </tr> </tbody> </table> <p><b>Model No: PE9119</b> SMC Plug To SMC Jack</p>	PRICE		1-24	\$38.45	25-49	\$35.76	50-99	\$33.07	100 +	\$30.76	 <table border="1"> <thead> <tr> <th colspan="2">PRICE</th> </tr> </thead> <tbody> <tr> <td>1-24</td> <td>\$41.14</td> </tr> <tr> <td>25-49</td> <td>\$38.26</td> </tr> <tr> <td>50-99</td> <td>\$35.38</td> </tr> <tr> <td>100 +</td> <td>\$32.91</td> </tr> </tbody> </table> <p><b>Model No: PE9303</b> SMC Plug To SMC Jack Right Angle</p>	PRICE		1-24	\$41.14	25-49	\$38.26	50-99	\$35.38	100 +	\$32.91	 <table border="1"> <thead> <tr> <th colspan="2">PRICE</th> </tr> </thead> <tbody> <tr> <td>1-24</td> <td>\$20.87</td> </tr> <tr> <td>25-49</td> <td>\$19.41</td> </tr> <tr> <td>50-99</td> <td>\$17.95</td> </tr> <tr> <td>100 +</td> <td>\$16.70</td> </tr> </tbody> </table> <p><b>Model No: PE9115</b> SMC Jack To SMC Jack</p>	PRICE		1-24	\$20.87	25-49	\$19.41	50-99	\$17.95	100 +	\$16.70
	PRICE																																											
1-24	\$20.87																																											
25-49	\$19.41																																											
50-99	\$17.95																																											
100 +	\$16.70																																											
PRICE																																												
1-24	\$38.45																																											
25-49	\$35.76																																											
50-99	\$33.07																																											
100 +	\$30.76																																											
PRICE																																												
1-24	\$41.14																																											
25-49	\$38.26																																											
50-99	\$35.38																																											
100 +	\$32.91																																											
PRICE																																												
1-24	\$20.87																																											
25-49	\$19.41																																											
50-99	\$17.95																																											
100 +	\$16.70																																											
2	 <table border="1"> <thead> <tr> <th colspan="2">PRICE</th> </tr> </thead> <tbody> <tr> <td>1-24</td> <td>\$24.17</td> </tr> <tr> <td>25-49</td> <td>\$22.48</td> </tr> <tr> <td>50-99</td> <td>\$20.79</td> </tr> <tr> <td>100 +</td> <td>\$19.34</td> </tr> </tbody> </table> <p><b>Model No: PE9121</b> SMC Jack To SMC Jack Bulkhead Mounting Hole B01</p>	PRICE		1-24	\$24.17	25-49	\$22.48	50-99	\$20.79	100 +	\$19.34	 <table border="1"> <thead> <tr> <th colspan="2">PRICE</th> </tr> </thead> <tbody> <tr> <td>1-24</td> <td>\$41.14</td> </tr> <tr> <td>25-49</td> <td>\$38.26</td> </tr> <tr> <td>50-99</td> <td>\$35.38</td> </tr> <tr> <td>100 +</td> <td>\$32.91</td> </tr> </tbody> </table> <p><b>Model No: PE9305</b> SMC "T" Plug-Plug-Plug</p>	PRICE		1-24	\$41.14	25-49	\$38.26	50-99	\$35.38	100 +	\$32.91	 <table border="1"> <thead> <tr> <th colspan="2">PRICE</th> </tr> </thead> <tbody> <tr> <td>1-24</td> <td>\$28.27</td> </tr> <tr> <td>25-49</td> <td>\$26.29</td> </tr> <tr> <td>50-99</td> <td>\$24.31</td> </tr> <tr> <td>100 +</td> <td>\$22.62</td> </tr> </tbody> </table> <p><b>Model No: PE9242</b> SMC "T" Jack-Plug-Jack</p>	PRICE		1-24	\$28.27	25-49	\$26.29	50-99	\$24.31	100 +	\$22.62	 <table border="1"> <thead> <tr> <th colspan="2">PRICE</th> </tr> </thead> <tbody> <tr> <td>1-24</td> <td>\$47.12</td> </tr> <tr> <td>25-49</td> <td>\$43.82</td> </tr> <tr> <td>50-99</td> <td>\$40.52</td> </tr> <tr> <td>100 +</td> <td>\$37.70</td> </tr> </tbody> </table> <p><b>Model No: PE9304</b> SMC "T" Jack-Jack-Jack</p>	PRICE		1-24	\$47.12	25-49	\$43.82	50-99	\$40.52	100 +	\$37.70
	PRICE																																											
1-24	\$24.17																																											
25-49	\$22.48																																											
50-99	\$20.79																																											
100 +	\$19.34																																											
PRICE																																												
1-24	\$41.14																																											
25-49	\$38.26																																											
50-99	\$35.38																																											
100 +	\$32.91																																											
PRICE																																												
1-24	\$28.27																																											
25-49	\$26.29																																											
50-99	\$24.31																																											
100 +	\$22.62																																											
PRICE																																												
1-24	\$47.12																																											
25-49	\$43.82																																											
50-99	\$40.52																																											
100 +	\$37.70																																											
3	<p><b>SMC Between-Series</b></p> <p>→</p>	 <table border="1"> <thead> <tr> <th colspan="2">PRICE</th> </tr> </thead> <tbody> <tr> <td>1-24</td> <td>\$29.39</td> </tr> <tr> <td>25-49</td> <td>\$27.33</td> </tr> <tr> <td>50-99</td> <td>\$25.28</td> </tr> <tr> <td>100 +</td> <td>\$23.51</td> </tr> </tbody> </table> <p><b>Model No: PE9281</b> SMC Plug To SMB Plug</p>	PRICE		1-24	\$29.39	25-49	\$27.33	50-99	\$25.28	100 +	\$23.51	 <table border="1"> <thead> <tr> <th colspan="2">PRICE</th> </tr> </thead> <tbody> <tr> <td>1-24</td> <td>\$29.39</td> </tr> <tr> <td>25-49</td> <td>\$27.33</td> </tr> <tr> <td>50-99</td> <td>\$25.28</td> </tr> <tr> <td>100 +</td> <td>\$23.51</td> </tr> </tbody> </table> <p><b>Model No: PE9284</b> SMC Plug To SMB Jack</p>	PRICE		1-24	\$29.39	25-49	\$27.33	50-99	\$25.28	100 +	\$23.51	 <table border="1"> <thead> <tr> <th colspan="2">PRICE</th> </tr> </thead> <tbody> <tr> <td>1-24</td> <td>\$30.35</td> </tr> <tr> <td>25-49</td> <td>\$28.23</td> </tr> <tr> <td>50-99</td> <td>\$26.10</td> </tr> <tr> <td>100 +</td> <td>\$24.28</td> </tr> </tbody> </table> <p><b>Model No: PE9282</b> SMC Jack To SMB Plug</p>	PRICE		1-24	\$30.35	25-49	\$28.23	50-99	\$26.10	100 +	\$24.28										
	PRICE																																											
1-24	\$29.39																																											
25-49	\$27.33																																											
50-99	\$25.28																																											
100 +	\$23.51																																											
PRICE																																												
1-24	\$29.39																																											
25-49	\$27.33																																											
50-99	\$25.28																																											
100 +	\$23.51																																											
PRICE																																												
1-24	\$30.35																																											
25-49	\$28.23																																											
50-99	\$26.10																																											
100 +	\$24.28																																											
4	 <table border="1"> <thead> <tr> <th colspan="2">PRICE</th> </tr> </thead> <tbody> <tr> <td>1-24</td> <td>\$29.39</td> </tr> <tr> <td>25-49</td> <td>\$27.33</td> </tr> <tr> <td>50-99</td> <td>\$25.28</td> </tr> <tr> <td>100 +</td> <td>\$23.51</td> </tr> </tbody> </table> <p><b>Model No: PE9283</b> SMC Jack To SMB Jack</p>	PRICE		1-24	\$29.39	25-49	\$27.33	50-99	\$25.28	100 +	\$23.51	 <table border="1"> <thead> <tr> <th colspan="2">PRICE</th> </tr> </thead> <tbody> <tr> <td>1-24</td> <td>\$39.32</td> </tr> <tr> <td>25-49</td> <td>\$36.57</td> </tr> <tr> <td>50-99</td> <td>\$33.82</td> </tr> <tr> <td>100 +</td> <td>\$31.46</td> </tr> </tbody> </table> <p><b>Model No: PE9139</b> SMC Plug To BNC Male</p>	PRICE		1-24	\$39.32	25-49	\$36.57	50-99	\$33.82	100 +	\$31.46	 <table border="1"> <thead> <tr> <th colspan="2">PRICE</th> </tr> </thead> <tbody> <tr> <td>1-24</td> <td>\$38.71</td> </tr> <tr> <td>25-49</td> <td>\$36.00</td> </tr> <tr> <td>50-99</td> <td>\$33.29</td> </tr> <tr> <td>100 +</td> <td>\$30.97</td> </tr> </tbody> </table> <p><b>Model No: PE9141</b> SMC Plug To BNC Female</p>	PRICE		1-24	\$38.71	25-49	\$36.00	50-99	\$33.29	100 +	\$30.97	 <table border="1"> <thead> <tr> <th colspan="2">PRICE</th> </tr> </thead> <tbody> <tr> <td>1-24</td> <td>\$38.71</td> </tr> <tr> <td>25-49</td> <td>\$36.00</td> </tr> <tr> <td>50-99</td> <td>\$33.29</td> </tr> <tr> <td>100 +</td> <td>\$30.97</td> </tr> </tbody> </table> <p><b>Model No: PE9138</b> SMC Jack To BNC Male</p>	PRICE		1-24	\$38.71	25-49	\$36.00	50-99	\$33.29	100 +	\$30.97
	PRICE																																											
1-24	\$29.39																																											
25-49	\$27.33																																											
50-99	\$25.28																																											
100 +	\$23.51																																											
PRICE																																												
1-24	\$39.32																																											
25-49	\$36.57																																											
50-99	\$33.82																																											
100 +	\$31.46																																											
PRICE																																												
1-24	\$38.71																																											
25-49	\$36.00																																											
50-99	\$33.29																																											
100 +	\$30.97																																											
PRICE																																												
1-24	\$38.71																																											
25-49	\$36.00																																											
50-99	\$33.29																																											
100 +	\$30.97																																											
5	 <table border="1"> <thead> <tr> <th colspan="2">PRICE</th> </tr> </thead> <tbody> <tr> <td>1-24</td> <td>\$75.64</td> </tr> <tr> <td>25-49</td> <td>\$70.35</td> </tr> <tr> <td>50-99</td> <td>\$65.05</td> </tr> <tr> <td>100 +</td> <td>\$60.51</td> </tr> </tbody> </table> <p><b>Model No: PE9140</b> SMC Jack To BNC Female</p>	PRICE		1-24	\$75.64	25-49	\$70.35	50-99	\$65.05	100 +	\$60.51	 <table border="1"> <thead> <tr> <th colspan="2">PRICE</th> </tr> </thead> <tbody> <tr> <td>1-24</td> <td>\$52.14</td> </tr> <tr> <td>25-49</td> <td>\$48.49</td> </tr> <tr> <td>50-99</td> <td>\$44.84</td> </tr> <tr> <td>100 +</td> <td>\$41.71</td> </tr> </tbody> </table> <p><b>Model No: PE9108</b> SMC Jack Bulkhead To BNC Female Mounting Hole B04</p>	PRICE		1-24	\$52.14	25-49	\$48.49	50-99	\$44.84	100 +	\$41.71	<p><b>10-32 In-Series</b></p> <p>→</p>	 <table border="1"> <thead> <tr> <th colspan="2">PRICE</th> </tr> </thead> <tbody> <tr> <td>1-24</td> <td>\$35.26</td> </tr> <tr> <td>25-49</td> <td>\$32.79</td> </tr> <tr> <td>50-99</td> <td>\$30.32</td> </tr> <tr> <td>100 +</td> <td>\$28.21</td> </tr> </tbody> </table> <p><b>Model No: PE9756</b> 10-32 Female To 10-32 Female</p>	PRICE		1-24	\$35.26	25-49	\$32.79	50-99	\$30.32	100 +	\$28.21										
	PRICE																																											
1-24	\$75.64																																											
25-49	\$70.35																																											
50-99	\$65.05																																											
100 +	\$60.51																																											
PRICE																																												
1-24	\$52.14																																											
25-49	\$48.49																																											
50-99	\$44.84																																											
100 +	\$41.71																																											
PRICE																																												
1-24	\$35.26																																											
25-49	\$32.79																																											
50-99	\$30.32																																											
100 +	\$28.21																																											
6	 <table border="1"> <thead> <tr> <th colspan="2">PRICE</th> </tr> </thead> <tbody> <tr> <td>1-24</td> <td>\$47.12</td> </tr> <tr> <td>25-49</td> <td>\$43.82</td> </tr> <tr> <td>50-99</td> <td>\$40.52</td> </tr> <tr> <td>100 +</td> <td>\$37.70</td> </tr> </tbody> </table> <p><b>Model No: PE9757</b> 10-32 Female To 10-32 Female Bulkhead, Mounting Hole B03</p>	PRICE		1-24	\$47.12	25-49	\$43.82	50-99	\$40.52	100 +	\$37.70	<p><b>10-32 Between-Series</b></p> <p>→</p>	 <table border="1"> <thead> <tr> <th colspan="2">PRICE</th> </tr> </thead> <tbody> <tr> <td>1-24</td> <td>\$50.67</td> </tr> <tr> <td>25-49</td> <td>\$47.12</td> </tr> <tr> <td>50-99</td> <td>\$43.58</td> </tr> <tr> <td>100 +</td> <td>\$40.54</td> </tr> </tbody> </table> <p><b>Model No: PE9751</b> 10-32 Male To BNC Male</p>	PRICE		1-24	\$50.67	25-49	\$47.12	50-99	\$43.58	100 +	\$40.54	 <table border="1"> <thead> <tr> <th colspan="2">PRICE</th> </tr> </thead> <tbody> <tr> <td>1-24</td> <td>\$50.67</td> </tr> <tr> <td>25-49</td> <td>\$47.12</td> </tr> <tr> <td>50-99</td> <td>\$43.58</td> </tr> <tr> <td>100 +</td> <td>\$40.54</td> </tr> </tbody> </table> <p><b>Model No: PE9753</b> 10-32 Male To BNC Female</p>	PRICE		1-24	\$50.67	25-49	\$47.12	50-99	\$43.58	100 +	\$40.54										
	PRICE																																											
1-24	\$47.12																																											
25-49	\$43.82																																											
50-99	\$40.52																																											
100 +	\$37.70																																											
PRICE																																												
1-24	\$50.67																																											
25-49	\$47.12																																											
50-99	\$43.58																																											
100 +	\$40.54																																											
PRICE																																												
1-24	\$50.67																																											
25-49	\$47.12																																											
50-99	\$43.58																																											
100 +	\$40.54																																											











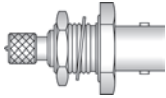
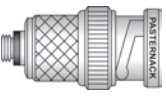
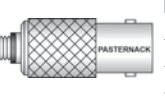

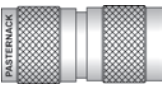

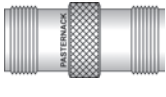
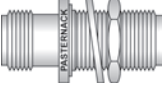
Adapters

See Our Website For Real-Time Stock Availability!

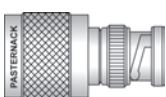
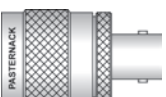
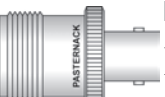
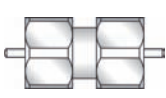
# ADAPTERS

See Adapter Locator on Pages 140-145 or the Adapter Matrix on Pages 138-139

See Page 246 for Mounting Holes

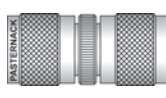
	A	B	C	D																																								
1	 <table border="1"> <thead> <tr> <th colspan="2">PRICE</th> </tr> </thead> <tbody> <tr> <td>1-24</td> <td>\$58.87</td> </tr> <tr> <td>25-49</td> <td>\$54.75</td> </tr> <tr> <td>50-99</td> <td>\$50.63</td> </tr> <tr> <td>100 +</td> <td>\$47.10</td> </tr> </tbody> </table> <p><b>Model No: PE9755</b> 10-32 Male Bulkhead To BNC Female Mounting Hole B05</p>	PRICE		1-24	\$58.87	25-49	\$54.75	50-99	\$50.63	100 +	\$47.10	 <table border="1"> <thead> <tr> <th colspan="2">PRICE</th> </tr> </thead> <tbody> <tr> <td>1-24</td> <td>\$46.21</td> </tr> <tr> <td>25-49</td> <td>\$42.98</td> </tr> <tr> <td>50-99</td> <td>\$39.74</td> </tr> <tr> <td>100 +</td> <td>\$36.97</td> </tr> </tbody> </table> <p><b>Model No: PE9750</b> 10-32 Female To BNC Male</p>	PRICE		1-24	\$46.21	25-49	\$42.98	50-99	\$39.74	100 +	\$36.97	 <table border="1"> <thead> <tr> <th colspan="2">PRICE</th> </tr> </thead> <tbody> <tr> <td>1-24</td> <td>\$46.21</td> </tr> <tr> <td>25-49</td> <td>\$42.98</td> </tr> <tr> <td>50-99</td> <td>\$39.74</td> </tr> <tr> <td>100 +</td> <td>\$36.97</td> </tr> </tbody> </table> <p><b>Model No: PE9752</b> 10-32 Female To BNC Female</p>	PRICE		1-24	\$46.21	25-49	\$42.98	50-99	\$39.74	100 +	\$36.97	 <table border="1"> <thead> <tr> <th colspan="2">PRICE</th> </tr> </thead> <tbody> <tr> <td>1-24</td> <td>\$47.12</td> </tr> <tr> <td>25-49</td> <td>\$43.82</td> </tr> <tr> <td>50-99</td> <td>\$40.52</td> </tr> <tr> <td>100 +</td> <td>\$37.70</td> </tr> </tbody> </table> <p><b>Model No: PE9754</b> 10-32 Female Bulkhead To BNC Female, Mounting Hole B05</p>	PRICE		1-24	\$47.12	25-49	\$43.82	50-99	\$40.52	100 +	\$37.70
	PRICE																																											
	1-24	\$58.87																																										
	25-49	\$54.75																																										
	50-99	\$50.63																																										
	100 +	\$47.10																																										
PRICE																																												
1-24	\$46.21																																											
25-49	\$42.98																																											
50-99	\$39.74																																											
100 +	\$36.97																																											
PRICE																																												
1-24	\$46.21																																											
25-49	\$42.98																																											
50-99	\$39.74																																											
100 +	\$36.97																																											
PRICE																																												
1-24	\$47.12																																											
25-49	\$43.82																																											
50-99	\$40.52																																											
100 +	\$37.70																																											
2	<b>SC In-Series</b> 																																											
	 <table border="1"> <thead> <tr> <th colspan="2">PRICE</th> </tr> </thead> <tbody> <tr> <td>1-24</td> <td>\$82.33</td> </tr> <tr> <td>25-49</td> <td>\$76.57</td> </tr> <tr> <td>50-99</td> <td>\$70.80</td> </tr> <tr> <td>100 +</td> <td>\$65.86</td> </tr> </tbody> </table> <p><b>Model No: PE9403</b> SC Male To SC Male</p>	PRICE		1-24	\$82.33	25-49	\$76.57	50-99	\$70.80	100 +	\$65.86	 <table border="1"> <thead> <tr> <th colspan="2">PRICE</th> </tr> </thead> <tbody> <tr> <td>1-24</td> <td>\$82.33</td> </tr> <tr> <td>25-49</td> <td>\$76.57</td> </tr> <tr> <td>50-99</td> <td>\$70.80</td> </tr> <tr> <td>100 +</td> <td>\$65.86</td> </tr> </tbody> </table> <p><b>Model No: PE9572</b> SC Male To SC Female</p>	PRICE		1-24	\$82.33	25-49	\$76.57	50-99	\$70.80	100 +	\$65.86	 <table border="1"> <thead> <tr> <th colspan="2">PRICE</th> </tr> </thead> <tbody> <tr> <td>1-24</td> <td>\$115.67</td> </tr> <tr> <td>25-49</td> <td>\$107.57</td> </tr> <tr> <td>50-99</td> <td>\$99.48</td> </tr> <tr> <td>100 +</td> <td>\$92.54</td> </tr> </tbody> </table> <p><b>Model No: PE9405</b> SC Male To SC Female Right Angle</p>	PRICE		1-24	\$115.67	25-49	\$107.57	50-99	\$99.48	100 +	\$92.54											
	PRICE																																											
1-24	\$82.33																																											
25-49	\$76.57																																											
50-99	\$70.80																																											
100 +	\$65.86																																											
PRICE																																												
1-24	\$82.33																																											
25-49	\$76.57																																											
50-99	\$70.80																																											
100 +	\$65.86																																											
PRICE																																												
1-24	\$115.67																																											
25-49	\$107.57																																											
50-99	\$99.48																																											
100 +	\$92.54																																											
 <table border="1"> <thead> <tr> <th colspan="2">PRICE</th> </tr> </thead> <tbody> <tr> <td>1-24</td> <td>\$80.96</td> </tr> <tr> <td>25-49</td> <td>\$75.29</td> </tr> <tr> <td>50-99</td> <td>\$69.63</td> </tr> <tr> <td>100 +</td> <td>\$64.77</td> </tr> </tbody> </table> <p><b>Model No: PE9404</b> SC Female To SC Female</p>	PRICE		1-24	\$80.96	25-49	\$75.29	50-99	\$69.63	100 +	\$64.77	 <table border="1"> <thead> <tr> <th colspan="2">PRICE</th> </tr> </thead> <tbody> <tr> <td>1-24</td> <td>\$104.12</td> </tr> <tr> <td>25-49</td> <td>\$96.83</td> </tr> <tr> <td>50-99</td> <td>\$89.54</td> </tr> <tr> <td>100 +</td> <td>\$83.30</td> </tr> </tbody> </table> <p><b>Model No: PE9573</b> SC Female To SC Female Bulkhead Mounting Hole B11</p>	PRICE		1-24	\$104.12	25-49	\$96.83	50-99	\$89.54	100 +	\$83.30	 <table border="1"> <thead> <tr> <th colspan="2">PRICE</th> </tr> </thead> <tbody> <tr> <td>1-24</td> <td>\$211.93</td> </tr> <tr> <td>25-49</td> <td>\$197.09</td> </tr> <tr> <td>50-99</td> <td>\$182.26</td> </tr> <tr> <td>100 +</td> <td>\$169.54</td> </tr> </tbody> </table> <p><b>Model No: PE9225</b> SC "T" Female-Male-Female</p>	PRICE		1-24	\$211.93	25-49	\$197.09	50-99	\$182.26	100 +	\$169.54	<b>SC Between-Series</b> 											
PRICE																																												
1-24	\$80.96																																											
25-49	\$75.29																																											
50-99	\$69.63																																											
100 +	\$64.77																																											
PRICE																																												
1-24	\$104.12																																											
25-49	\$96.83																																											
50-99	\$89.54																																											
100 +	\$83.30																																											
PRICE																																												
1-24	\$211.93																																											
25-49	\$197.09																																											
50-99	\$182.26																																											
100 +	\$169.54																																											
4	<b>LC In-Series</b> 																																											
	 <table border="1"> <thead> <tr> <th colspan="2">PRICE</th> </tr> </thead> <tbody> <tr> <td>1-24</td> <td>\$82.33</td> </tr> <tr> <td>25-49</td> <td>\$76.57</td> </tr> <tr> <td>50-99</td> <td>\$70.80</td> </tr> <tr> <td>100 +</td> <td>\$65.86</td> </tr> </tbody> </table> <p><b>Model No: PE9568</b> SC Male To BNC Male</p>	PRICE		1-24	\$82.33	25-49	\$76.57	50-99	\$70.80	100 +	\$65.86	 <table border="1"> <thead> <tr> <th colspan="2">PRICE</th> </tr> </thead> <tbody> <tr> <td>1-24</td> <td>\$105.43</td> </tr> <tr> <td>25-49</td> <td>\$98.05</td> </tr> <tr> <td>50-99</td> <td>\$90.67</td> </tr> <tr> <td>100 +</td> <td>\$84.34</td> </tr> </tbody> </table> <p><b>Model No: PE9200</b> SC Male To BNC Female</p>	PRICE		1-24	\$105.43	25-49	\$98.05	50-99	\$90.67	100 +	\$84.34	 <table border="1"> <thead> <tr> <th colspan="2">PRICE</th> </tr> </thead> <tbody> <tr> <td>1-24</td> <td>\$82.33</td> </tr> <tr> <td>25-49</td> <td>\$76.57</td> </tr> <tr> <td>50-99</td> <td>\$70.80</td> </tr> <tr> <td>100 +</td> <td>\$65.86</td> </tr> </tbody> </table> <p><b>Model No: PE9571</b> SC Female To BNC Female</p>	PRICE		1-24	\$82.33	25-49	\$76.57	50-99	\$70.80	100 +	\$65.86											
	PRICE																																											
1-24	\$82.33																																											
25-49	\$76.57																																											
50-99	\$70.80																																											
100 +	\$65.86																																											
PRICE																																												
1-24	\$105.43																																											
25-49	\$98.05																																											
50-99	\$90.67																																											
100 +	\$84.34																																											
PRICE																																												
1-24	\$82.33																																											
25-49	\$76.57																																											
50-99	\$70.80																																											
100 +	\$65.86																																											
 <table border="1"> <thead> <tr> <th colspan="2">PRICE</th> </tr> </thead> <tbody> <tr> <td>1-24</td> <td>\$196.78</td> </tr> <tr> <td>25-49</td> <td>\$183.01</td> </tr> <tr> <td>50-99</td> <td>\$169.23</td> </tr> <tr> <td>100 +</td> <td>\$157.42</td> </tr> </tbody> </table> <p><b>Model No: PE9569</b> LC Male To LC Male</p>	PRICE		1-24	\$196.78	25-49	\$183.01	50-99	\$169.23	100 +	\$157.42	 <table border="1"> <thead> <tr> <th colspan="2">PRICE</th> </tr> </thead> <tbody> <tr> <td>1-24</td> <td>\$300.95</td> </tr> <tr> <td>25-49</td> <td>\$279.88</td> </tr> <tr> <td>50-99</td> <td>\$258.82</td> </tr> <tr> <td>100 +</td> <td>\$240.76</td> </tr> </tbody> </table> <p><b>Model No: PE9398</b> LC Male To LC Female Right Angle</p>	PRICE		1-24	\$300.95	25-49	\$279.88	50-99	\$258.82	100 +	\$240.76	 <table border="1"> <thead> <tr> <th colspan="2">PRICE</th> </tr> </thead> <tbody> <tr> <td>1-24</td> <td>\$168.92</td> </tr> <tr> <td>25-49</td> <td>\$157.10</td> </tr> <tr> <td>50-99</td> <td>\$145.27</td> </tr> <tr> <td>100 +</td> <td>\$135.14</td> </tr> </tbody> </table> <p><b>Model No: PE9419</b> LC Female To LC Female</p>	PRICE		1-24	\$168.92	25-49	\$157.10	50-99	\$145.27	100 +	\$135.14	<b>LC Between-Series</b> 											
PRICE																																												
1-24	\$196.78																																											
25-49	\$183.01																																											
50-99	\$169.23																																											
100 +	\$157.42																																											
PRICE																																												
1-24	\$300.95																																											
25-49	\$279.88																																											
50-99	\$258.82																																											
100 +	\$240.76																																											
PRICE																																												
1-24	\$168.92																																											
25-49	\$157.10																																											
50-99	\$145.27																																											
100 +	\$135.14																																											
6	<b>HN In-Series</b> 																																											
	 <table border="1"> <thead> <tr> <th colspan="2">PRICE</th> </tr> </thead> <tbody> <tr> <td>1-24</td> <td>\$235.14</td> </tr> <tr> <td>25-49</td> <td>\$218.68</td> </tr> <tr> <td>50-99</td> <td>\$202.22</td> </tr> <tr> <td>100 +</td> <td>\$188.11</td> </tr> </tbody> </table> <p><b>Model No: PE9181</b> LC Male To HN Female</p>	PRICE		1-24	\$235.14	25-49	\$218.68	50-99	\$202.22	100 +	\$188.11	 <table border="1"> <thead> <tr> <th colspan="2">PRICE</th> </tr> </thead> <tbody> <tr> <td>1-24</td> <td>\$179.00</td> </tr> <tr> <td>25-49</td> <td>\$166.47</td> </tr> <tr> <td>50-99</td> <td>\$153.94</td> </tr> <tr> <td>100 +</td> <td>\$143.20</td> </tr> </tbody> </table> <p><b>Model No: PE9413</b> LC Female To HN Male</p>	PRICE		1-24	\$179.00	25-49	\$166.47	50-99	\$153.94	100 +	\$143.20	 <table border="1"> <thead> <tr> <th colspan="2">PRICE</th> </tr> </thead> <tbody> <tr> <td>1-24</td> <td>\$42.25</td> </tr> <tr> <td>25-49</td> <td>\$39.29</td> </tr> <tr> <td>50-99</td> <td>\$36.34</td> </tr> <tr> <td>100 +</td> <td>\$33.80</td> </tr> </tbody> </table> <p><b>Model No: PE9210</b> HN Male To HN Male</p>	PRICE		1-24	\$42.25	25-49	\$39.29	50-99	\$36.34	100 +	\$33.80											
	PRICE																																											
1-24	\$235.14																																											
25-49	\$218.68																																											
50-99	\$202.22																																											
100 +	\$188.11																																											
PRICE																																												
1-24	\$179.00																																											
25-49	\$166.47																																											
50-99	\$153.94																																											
100 +	\$143.20																																											
PRICE																																												
1-24	\$42.25																																											
25-49	\$39.29																																											
50-99	\$36.34																																											
100 +	\$33.80																																											

Adapters











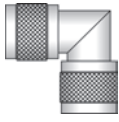



See Our Website For Real-Time Stock Availability!

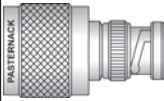
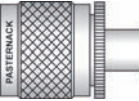

# ADAPTERS

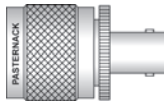
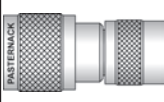
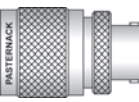
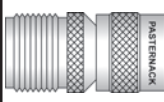
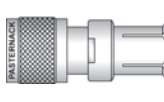
See Adapter Locator on Pages 140-145 or the Adapter Matrix on Pages 138-139

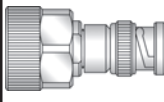
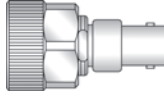
See Page 246 for Mounting Holes

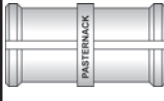
	A	B	C	D																																								
1	 <table border="1"> <thead> <tr> <th colspan="2">PRICE</th> </tr> </thead> <tbody> <tr> <td>1-24</td> <td>\$86.23</td> </tr> <tr> <td>25-49</td> <td>\$80.19</td> </tr> <tr> <td>50-99</td> <td>\$74.16</td> </tr> <tr> <td>100 +</td> <td>\$68.98</td> </tr> </tbody> </table> <p>Model No: <b>PE9577</b> HN Male To HN Male Right Angle</p>	PRICE		1-24	\$86.23	25-49	\$80.19	50-99	\$74.16	100 +	\$68.98	 <table border="1"> <thead> <tr> <th colspan="2">PRICE</th> </tr> </thead> <tbody> <tr> <td>1-24</td> <td>\$70.68</td> </tr> <tr> <td>25-49</td> <td>\$65.73</td> </tr> <tr> <td>50-99</td> <td>\$60.78</td> </tr> <tr> <td>100 +</td> <td>\$56.54</td> </tr> </tbody> </table> <p>Model No: <b>PE9576</b> HN Male To HN Female</p>	PRICE		1-24	\$70.68	25-49	\$65.73	50-99	\$60.78	100 +	\$56.54	 <table border="1"> <thead> <tr> <th colspan="2">PRICE</th> </tr> </thead> <tbody> <tr> <td>1-24</td> <td>\$49.25</td> </tr> <tr> <td>25-49</td> <td>\$45.80</td> </tr> <tr> <td>50-99</td> <td>\$42.36</td> </tr> <tr> <td>100 +</td> <td>\$39.40</td> </tr> </tbody> </table> <p>Model No: <b>PE9205</b> HN Male To HN Female Right Angle</p>	PRICE		1-24	\$49.25	25-49	\$45.80	50-99	\$42.36	100 +	\$39.40	 <table border="1"> <thead> <tr> <th colspan="2">PRICE</th> </tr> </thead> <tbody> <tr> <td>1-24</td> <td>\$40.43</td> </tr> <tr> <td>25-49</td> <td>\$37.60</td> </tr> <tr> <td>50-99</td> <td>\$34.77</td> </tr> <tr> <td>100 +</td> <td>\$32.34</td> </tr> </tbody> </table> <p>Model No: <b>PE9580</b> HN Female To HN Female</p>	PRICE		1-24	\$40.43	25-49	\$37.60	50-99	\$34.77	100 +	\$32.34
	PRICE																																											
1-24	\$86.23																																											
25-49	\$80.19																																											
50-99	\$74.16																																											
100 +	\$68.98																																											
PRICE																																												
1-24	\$70.68																																											
25-49	\$65.73																																											
50-99	\$60.78																																											
100 +	\$56.54																																											
PRICE																																												
1-24	\$49.25																																											
25-49	\$45.80																																											
50-99	\$42.36																																											
100 +	\$39.40																																											
PRICE																																												
1-24	\$40.43																																											
25-49	\$37.60																																											
50-99	\$34.77																																											
100 +	\$32.34																																											
2	 <table border="1"> <thead> <tr> <th colspan="2">PRICE</th> </tr> </thead> <tbody> <tr> <td>1-24</td> <td>\$47.83</td> </tr> <tr> <td>25-49</td> <td>\$44.48</td> </tr> <tr> <td>50-99</td> <td>\$41.13</td> </tr> <tr> <td>100 +</td> <td>\$38.26</td> </tr> </tbody> </table> <p>Model No: <b>PE9193</b> HN Female To HN Female Bulkhead Mounting Hole G03</p>	PRICE		1-24	\$47.83	25-49	\$44.48	50-99	\$41.13	100 +	\$38.26	 <table border="1"> <thead> <tr> <th colspan="2">PRICE</th> </tr> </thead> <tbody> <tr> <td>1-24</td> <td>\$94.08</td> </tr> <tr> <td>25-49</td> <td>\$87.49</td> </tr> <tr> <td>50-99</td> <td>\$80.91</td> </tr> <tr> <td>100 +</td> <td>\$75.26</td> </tr> </tbody> </table> <p>Model No: <b>PE9578</b> HN "T" Male-Female-Male</p>	PRICE		1-24	\$94.08	25-49	\$87.49	50-99	\$80.91	100 +	\$75.26	 <table border="1"> <thead> <tr> <th colspan="2">PRICE</th> </tr> </thead> <tbody> <tr> <td>1-24</td> <td>\$94.08</td> </tr> <tr> <td>25-49</td> <td>\$87.49</td> </tr> <tr> <td>50-99</td> <td>\$80.91</td> </tr> <tr> <td>100 +</td> <td>\$75.26</td> </tr> </tbody> </table> <p>Model No: <b>PE9575</b> HN "T" Female-Male-Female</p>	PRICE		1-24	\$94.08	25-49	\$87.49	50-99	\$80.91	100 +	\$75.26	 <table border="1"> <thead> <tr> <th colspan="2">PRICE</th> </tr> </thead> <tbody> <tr> <td>1-24</td> <td>\$94.08</td> </tr> <tr> <td>25-49</td> <td>\$87.49</td> </tr> <tr> <td>50-99</td> <td>\$80.91</td> </tr> <tr> <td>100 +</td> <td>\$75.26</td> </tr> </tbody> </table> <p>Model No: <b>PE9574</b> HN "T" Female-Female-Female</p>	PRICE		1-24	\$94.08	25-49	\$87.49	50-99	\$80.91	100 +	\$75.26
	PRICE																																											
1-24	\$47.83																																											
25-49	\$44.48																																											
50-99	\$41.13																																											
100 +	\$38.26																																											
PRICE																																												
1-24	\$94.08																																											
25-49	\$87.49																																											
50-99	\$80.91																																											
100 +	\$75.26																																											
PRICE																																												
1-24	\$94.08																																											
25-49	\$87.49																																											
50-99	\$80.91																																											
100 +	\$75.26																																											
PRICE																																												
1-24	\$94.08																																											
25-49	\$87.49																																											
50-99	\$80.91																																											
100 +	\$75.26																																											
3	<p style="text-align: center;"><b>HN</b> <i>Between-Series</i></p> <p style="text-align: center;">→</p>	 <table border="1"> <thead> <tr> <th colspan="2">PRICE</th> </tr> </thead> <tbody> <tr> <td>1-24</td> <td>\$59.02</td> </tr> <tr> <td>25-49</td> <td>\$54.89</td> </tr> <tr> <td>50-99</td> <td>\$50.76</td> </tr> <tr> <td>100 +</td> <td>\$47.22</td> </tr> </tbody> </table> <p>Model No: <b>PE9567</b> HN Male To BNC Male</p>	PRICE		1-24	\$59.02	25-49	\$54.89	50-99	\$50.76	100 +	\$47.22	 <table border="1"> <thead> <tr> <th colspan="2">PRICE</th> </tr> </thead> <tbody> <tr> <td>1-24</td> <td>\$45.35</td> </tr> <tr> <td>25-49</td> <td>\$42.18</td> </tr> <tr> <td>50-99</td> <td>\$39.00</td> </tr> <tr> <td>100 +</td> <td>\$36.28</td> </tr> </tbody> </table> <p>Model No: <b>PE9126</b> HN Male To BNC Female</p>	PRICE		1-24	\$45.35	25-49	\$42.18	50-99	\$39.00	100 +	\$36.28	 <table border="1"> <thead> <tr> <th colspan="2">PRICE</th> </tr> </thead> <tbody> <tr> <td>1-24</td> <td>\$46.21</td> </tr> <tr> <td>25-49</td> <td>\$42.98</td> </tr> <tr> <td>50-99</td> <td>\$39.74</td> </tr> <tr> <td>100 +</td> <td>\$36.97</td> </tr> </tbody> </table> <p>Model No: <b>PE9129</b> HN Female To BNC Male</p>	PRICE		1-24	\$46.21	25-49	\$42.98	50-99	\$39.74	100 +	\$36.97										
	PRICE																																											
1-24	\$59.02																																											
25-49	\$54.89																																											
50-99	\$50.76																																											
100 +	\$47.22																																											
PRICE																																												
1-24	\$45.35																																											
25-49	\$42.18																																											
50-99	\$39.00																																											
100 +	\$36.28																																											
PRICE																																												
1-24	\$46.21																																											
25-49	\$42.98																																											
50-99	\$39.74																																											
100 +	\$36.97																																											
4	 <table border="1"> <thead> <tr> <th colspan="2">PRICE</th> </tr> </thead> <tbody> <tr> <td>1-24</td> <td>\$105.89</td> </tr> <tr> <td>25-49</td> <td>\$98.48</td> </tr> <tr> <td>50-99</td> <td>\$91.07</td> </tr> <tr> <td>100 +</td> <td>\$84.71</td> </tr> </tbody> </table> <p>Model No: <b>PE9264</b> HN Male To MHV Female</p>	PRICE		1-24	\$105.89	25-49	\$98.48	50-99	\$91.07	100 +	\$84.71	 <table border="1"> <thead> <tr> <th colspan="2">PRICE</th> </tr> </thead> <tbody> <tr> <td>1-24</td> <td>\$70.68</td> </tr> <tr> <td>25-49</td> <td>\$65.73</td> </tr> <tr> <td>50-99</td> <td>\$60.78</td> </tr> <tr> <td>100 +</td> <td>\$56.54</td> </tr> </tbody> </table> <p>Model No: <b>PE9579</b> HN Male To C Male</p>	PRICE		1-24	\$70.68	25-49	\$65.73	50-99	\$60.78	100 +	\$56.54	 <table border="1"> <thead> <tr> <th colspan="2">PRICE</th> </tr> </thead> <tbody> <tr> <td>1-24</td> <td>\$48.94</td> </tr> <tr> <td>25-49</td> <td>\$45.51</td> </tr> <tr> <td>50-99</td> <td>\$42.09</td> </tr> <tr> <td>100 +</td> <td>\$39.15</td> </tr> </tbody> </table> <p>Model No: <b>PE9296</b> HN Male To C Female</p>	PRICE		1-24	\$48.94	25-49	\$45.51	50-99	\$42.09	100 +	\$39.15	 <table border="1"> <thead> <tr> <th colspan="2">PRICE</th> </tr> </thead> <tbody> <tr> <td>1-24</td> <td>\$70.68</td> </tr> <tr> <td>25-49</td> <td>\$65.73</td> </tr> <tr> <td>50-99</td> <td>\$60.78</td> </tr> <tr> <td>100 +</td> <td>\$56.54</td> </tr> </tbody> </table> <p>Model No: <b>PE9212</b> HN Female To C Male</p>	PRICE		1-24	\$70.68	25-49	\$65.73	50-99	\$60.78	100 +	\$56.54
	PRICE																																											
1-24	\$105.89																																											
25-49	\$98.48																																											
50-99	\$91.07																																											
100 +	\$84.71																																											
PRICE																																												
1-24	\$70.68																																											
25-49	\$65.73																																											
50-99	\$60.78																																											
100 +	\$56.54																																											
PRICE																																												
1-24	\$48.94																																											
25-49	\$45.51																																											
50-99	\$42.09																																											
100 +	\$39.15																																											
PRICE																																												
1-24	\$70.68																																											
25-49	\$65.73																																											
50-99	\$60.78																																											
100 +	\$56.54																																											
5	 <table border="1"> <thead> <tr> <th colspan="2">PRICE</th> </tr> </thead> <tbody> <tr> <td>1-24</td> <td>\$168.51</td> </tr> <tr> <td>25-49</td> <td>\$156.71</td> </tr> <tr> <td>50-99</td> <td>\$144.92</td> </tr> <tr> <td>100 +</td> <td>\$134.81</td> </tr> </tbody> </table> <p>Model No: <b>PE9386</b> HN Male To GR874</p>	PRICE		1-24	\$168.51	25-49	\$156.71	50-99	\$144.92	100 +	\$134.81	 <table border="1"> <thead> <tr> <th colspan="2">PRICE</th> </tr> </thead> <tbody> <tr> <td>1-24</td> <td>\$168.51</td> </tr> <tr> <td>25-49</td> <td>\$156.71</td> </tr> <tr> <td>50-99</td> <td>\$144.92</td> </tr> <tr> <td>100 +</td> <td>\$134.81</td> </tr> </tbody> </table> <p>Model No: <b>PE9387</b> HN Female To GR874</p>	PRICE		1-24	\$168.51	25-49	\$156.71	50-99	\$144.92	100 +	\$134.81	<p style="text-align: center;"><b>7mm</b> <i>Between-Series</i></p> <p style="text-align: center;">→</p>	 <table border="1"> <thead> <tr> <th colspan="2">PRICE</th> </tr> </thead> <tbody> <tr> <td>1-24</td> <td>\$235.44</td> </tr> <tr> <td>25-49</td> <td>\$218.96</td> </tr> <tr> <td>50-99</td> <td>\$202.48</td> </tr> <tr> <td>100 +</td> <td>\$188.35</td> </tr> </tbody> </table> <p><b>PRECISION</b> Model No: <b>PE9221</b> 7mm To BNC Male Max VSWR 1.15:1 @ 8 GHz</p>	PRICE		1-24	\$235.44	25-49	\$218.96	50-99	\$202.48	100 +	\$188.35										
	PRICE																																											
1-24	\$168.51																																											
25-49	\$156.71																																											
50-99	\$144.92																																											
100 +	\$134.81																																											
PRICE																																												
1-24	\$168.51																																											
25-49	\$156.71																																											
50-99	\$144.92																																											
100 +	\$134.81																																											
PRICE																																												
1-24	\$235.44																																											
25-49	\$218.96																																											
50-99	\$202.48																																											
100 +	\$188.35																																											
6	 <table border="1"> <thead> <tr> <th colspan="2">PRICE</th> </tr> </thead> <tbody> <tr> <td>1-24</td> <td>\$173.63</td> </tr> <tr> <td>25-49</td> <td>\$161.48</td> </tr> <tr> <td>50-99</td> <td>\$149.32</td> </tr> <tr> <td>100 +</td> <td>\$138.90</td> </tr> </tbody> </table> <p><b>PRECISION</b> Model No: <b>PE9220</b> 7mm To BNC Female Max VSWR 1.15:1 @ 8 GHz</p>	PRICE		1-24	\$173.63	25-49	\$161.48	50-99	\$149.32	100 +	\$138.90	<p style="text-align: center;"><b>SMP</b> <i>In-Series</i></p> <p style="text-align: center;">→</p>	 <table border="1"> <thead> <tr> <th colspan="2">PRICE</th> </tr> </thead> <tbody> <tr> <td>1-24</td> <td>\$43.77</td> </tr> <tr> <td>25-49</td> <td>\$40.71</td> </tr> <tr> <td>50-99</td> <td>\$37.64</td> </tr> <tr> <td>100 +</td> <td>\$35.02</td> </tr> </tbody> </table> <p><b>NEW</b> Model No: <b>PE91004</b> SMP Female To SMP Female, 22.4mm Long, Bullet</p>	PRICE		1-24	\$43.77	25-49	\$40.71	50-99	\$37.64	100 +	\$35.02	 <table border="1"> <thead> <tr> <th colspan="2">PRICE</th> </tr> </thead> <tbody> <tr> <td>1-24</td> <td>\$30.10</td> </tr> <tr> <td>25-49</td> <td>\$27.99</td> </tr> <tr> <td>50-99</td> <td>\$25.89</td> </tr> <tr> <td>100 +</td> <td>\$24.08</td> </tr> </tbody> </table> <p>Model No: <b>PE9686</b> SMP Female To SMP Female</p>	PRICE		1-24	\$30.10	25-49	\$27.99	50-99	\$25.89	100 +	\$24.08										
	PRICE																																											
1-24	\$173.63																																											
25-49	\$161.48																																											
50-99	\$149.32																																											
100 +	\$138.90																																											
PRICE																																												
1-24	\$43.77																																											
25-49	\$40.71																																											
50-99	\$37.64																																											
100 +	\$35.02																																											
PRICE																																												
1-24	\$30.10																																											
25-49	\$27.99																																											
50-99	\$25.89																																											
100 +	\$24.08																																											

















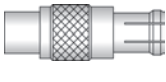

Adapters

See Our Website For Real-Time Stock Availability!

# ADAPTERS

See Adapter Locator on Pages 140-145 or the Adapter Matrix on Pages 138-139

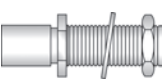
See Page 246 for Mounting Holes

	A	B	C	D																																								
1	 <table border="1"> <thead> <tr> <th colspan="2">PRICE</th> </tr> </thead> <tbody> <tr> <td>1-24</td> <td>\$45.09</td> </tr> <tr> <td>25-49</td> <td>\$41.93</td> </tr> <tr> <td>50-99</td> <td>\$38.78</td> </tr> <tr> <td>100 +</td> <td>\$36.07</td> </tr> </tbody> </table> <p>Model No: <b>PE9775</b> SMP Female To SMP Female, 19.5mm Long, Bullet</p>	PRICE		1-24	\$45.09	25-49	\$41.93	50-99	\$38.78	100 +	\$36.07	 <table border="1"> <thead> <tr> <th colspan="2">PRICE</th> </tr> </thead> <tbody> <tr> <td>1-24</td> <td>\$45.85</td> </tr> <tr> <td>25-49</td> <td>\$42.64</td> </tr> <tr> <td>50-99</td> <td>\$39.43</td> </tr> <tr> <td>100 +</td> <td>\$36.68</td> </tr> </tbody> </table> <p>Model No: <b>PE9776</b> SMP Female To SMP Female, 12.6mm Long, Bullet</p>	PRICE		1-24	\$45.85	25-49	\$42.64	50-99	\$39.43	100 +	\$36.68	 <table border="1"> <thead> <tr> <th colspan="2">PRICE</th> </tr> </thead> <tbody> <tr> <td>1-24</td> <td>\$35.26</td> </tr> <tr> <td>25-49</td> <td>\$32.79</td> </tr> <tr> <td>50-99</td> <td>\$30.32</td> </tr> <tr> <td>100 +</td> <td>\$28.21</td> </tr> </tbody> </table> <p>Model No: <b>PE9777</b> SMP Female To SMP Female 6.45mm Long, Bullet</p>	PRICE		1-24	\$35.26	25-49	\$32.79	50-99	\$30.32	100 +	\$28.21	<p><b>Mini SMP In-Series</b></p> <p>→</p>										
PRICE																																												
1-24	\$45.09																																											
25-49	\$41.93																																											
50-99	\$38.78																																											
100 +	\$36.07																																											
PRICE																																												
1-24	\$45.85																																											
25-49	\$42.64																																											
50-99	\$39.43																																											
100 +	\$36.68																																											
PRICE																																												
1-24	\$35.26																																											
25-49	\$32.79																																											
50-99	\$30.32																																											
100 +	\$28.21																																											
2	 <table border="1"> <thead> <tr> <th colspan="2">PRICE</th> </tr> </thead> <tbody> <tr> <td>1-24</td> <td>\$34.71</td> </tr> <tr> <td>25-49</td> <td>\$32.28</td> </tr> <tr> <td>50-99</td> <td>\$29.85</td> </tr> <tr> <td>100 +</td> <td>\$27.77</td> </tr> </tbody> </table> <p>Model No: <b>PE9780</b> Mini SMP Female To Mini SMP Female 5.3mm Long, 65 GHz, Bullet</p>	PRICE		1-24	\$34.71	25-49	\$32.28	50-99	\$29.85	100 +	\$27.77	<p><b>MMCX In-Series</b></p> <p>→</p>	 <table border="1"> <thead> <tr> <th colspan="2">PRICE</th> </tr> </thead> <tbody> <tr> <td>1-24</td> <td>\$47.12</td> </tr> <tr> <td>25-49</td> <td>\$43.82</td> </tr> <tr> <td>50-99</td> <td>\$40.52</td> </tr> <tr> <td>100 +</td> <td>\$37.70</td> </tr> </tbody> </table> <p>Model No: <b>PE9480</b> MMCX Plug To MMCX Jack</p>	PRICE		1-24	\$47.12	25-49	\$43.82	50-99	\$40.52	100 +	\$37.70	 <table border="1"> <thead> <tr> <th colspan="2">PRICE</th> </tr> </thead> <tbody> <tr> <td>1-24</td> <td>\$48.33</td> </tr> <tr> <td>25-49</td> <td>\$44.95</td> </tr> <tr> <td>50-99</td> <td>\$41.56</td> </tr> <tr> <td>100 +</td> <td>\$38.66</td> </tr> </tbody> </table> <p>Model No: <b>PE9523</b> MMCX Jack To MMCX Jack</p>	PRICE		1-24	\$48.33	25-49	\$44.95	50-99	\$41.56	100 +	\$38.66										
PRICE																																												
1-24	\$34.71																																											
25-49	\$32.28																																											
50-99	\$29.85																																											
100 +	\$27.77																																											
PRICE																																												
1-24	\$47.12																																											
25-49	\$43.82																																											
50-99	\$40.52																																											
100 +	\$37.70																																											
PRICE																																												
1-24	\$48.33																																											
25-49	\$44.95																																											
50-99	\$41.56																																											
100 +	\$38.66																																											
3	 <table border="1"> <thead> <tr> <th colspan="2">PRICE</th> </tr> </thead> <tbody> <tr> <td>1-24</td> <td>\$52.03</td> </tr> <tr> <td>25-49</td> <td>\$48.39</td> </tr> <tr> <td>50-99</td> <td>\$44.75</td> </tr> <tr> <td>100 +</td> <td>\$41.62</td> </tr> </tbody> </table> <p>Model No: <b>PE9522</b> MMCX Jack To MMCX Jack Bulkhead Mounting Hole B01</p>	PRICE		1-24	\$52.03	25-49	\$48.39	50-99	\$44.75	100 +	\$41.62	<p><b>MMCX Between-Series</b></p> <p>→</p>	 <table border="1"> <thead> <tr> <th colspan="2">PRICE</th> </tr> </thead> <tbody> <tr> <td>1-24</td> <td>\$58.87</td> </tr> <tr> <td>25-49</td> <td>\$54.75</td> </tr> <tr> <td>50-99</td> <td>\$50.63</td> </tr> <tr> <td>100 +</td> <td>\$47.10</td> </tr> </tbody> </table> <p>Model No: <b>PE9527</b> MMCX Plug To MCX Plug</p>	PRICE		1-24	\$58.87	25-49	\$54.75	50-99	\$50.63	100 +	\$47.10	 <table border="1"> <thead> <tr> <th colspan="2">PRICE</th> </tr> </thead> <tbody> <tr> <td>1-24</td> <td>\$58.87</td> </tr> <tr> <td>25-49</td> <td>\$54.75</td> </tr> <tr> <td>50-99</td> <td>\$50.63</td> </tr> <tr> <td>100 +</td> <td>\$47.10</td> </tr> </tbody> </table> <p>Model No: <b>PE9525</b> MMCX Plug To MCX Jack</p>	PRICE		1-24	\$58.87	25-49	\$54.75	50-99	\$50.63	100 +	\$47.10										
PRICE																																												
1-24	\$52.03																																											
25-49	\$48.39																																											
50-99	\$44.75																																											
100 +	\$41.62																																											
PRICE																																												
1-24	\$58.87																																											
25-49	\$54.75																																											
50-99	\$50.63																																											
100 +	\$47.10																																											
PRICE																																												
1-24	\$58.87																																											
25-49	\$54.75																																											
50-99	\$50.63																																											
100 +	\$47.10																																											
4	 <table border="1"> <thead> <tr> <th colspan="2">PRICE</th> </tr> </thead> <tbody> <tr> <td>1-24</td> <td>\$58.87</td> </tr> <tr> <td>25-49</td> <td>\$54.75</td> </tr> <tr> <td>50-99</td> <td>\$50.63</td> </tr> <tr> <td>100 +</td> <td>\$47.10</td> </tr> </tbody> </table> <p>Model No: <b>PE9528</b> MMCX Jack To MCX Plug</p>	PRICE		1-24	\$58.87	25-49	\$54.75	50-99	\$50.63	100 +	\$47.10	 <table border="1"> <thead> <tr> <th colspan="2">PRICE</th> </tr> </thead> <tbody> <tr> <td>1-24</td> <td>\$58.87</td> </tr> <tr> <td>25-49</td> <td>\$54.75</td> </tr> <tr> <td>50-99</td> <td>\$50.63</td> </tr> <tr> <td>100 +</td> <td>\$47.10</td> </tr> </tbody> </table> <p>Model No: <b>PE9526</b> MMCX Jack To MCX Jack</p>	PRICE		1-24	\$58.87	25-49	\$54.75	50-99	\$50.63	100 +	\$47.10	 <table border="1"> <thead> <tr> <th colspan="2">PRICE</th> </tr> </thead> <tbody> <tr> <td>1-24</td> <td>\$64.70</td> </tr> <tr> <td>25-49</td> <td>\$60.17</td> </tr> <tr> <td>50-99</td> <td>\$55.64</td> </tr> <tr> <td>100 +</td> <td>\$51.76</td> </tr> </tbody> </table> <p>Model No: <b>PE9517</b> MMCX Plug To BNC Male</p>	PRICE		1-24	\$64.70	25-49	\$60.17	50-99	\$55.64	100 +	\$51.76	 <table border="1"> <thead> <tr> <th colspan="2">PRICE</th> </tr> </thead> <tbody> <tr> <td>1-24</td> <td>\$71.94</td> </tr> <tr> <td>25-49</td> <td>\$66.90</td> </tr> <tr> <td>50-99</td> <td>\$61.87</td> </tr> <tr> <td>100 +</td> <td>\$57.55</td> </tr> </tbody> </table> <p>Model No: <b>PE9519</b> MMCX Plug To BNC Female</p>	PRICE		1-24	\$71.94	25-49	\$66.90	50-99	\$61.87	100 +	\$57.55
PRICE																																												
1-24	\$58.87																																											
25-49	\$54.75																																											
50-99	\$50.63																																											
100 +	\$47.10																																											
PRICE																																												
1-24	\$58.87																																											
25-49	\$54.75																																											
50-99	\$50.63																																											
100 +	\$47.10																																											
PRICE																																												
1-24	\$64.70																																											
25-49	\$60.17																																											
50-99	\$55.64																																											
100 +	\$51.76																																											
PRICE																																												
1-24	\$71.94																																											
25-49	\$66.90																																											
50-99	\$61.87																																											
100 +	\$57.55																																											
5	 <table border="1"> <thead> <tr> <th colspan="2">PRICE</th> </tr> </thead> <tbody> <tr> <td>1-24</td> <td>\$64.70</td> </tr> <tr> <td>25-49</td> <td>\$60.17</td> </tr> <tr> <td>50-99</td> <td>\$55.64</td> </tr> <tr> <td>100 +</td> <td>\$51.76</td> </tr> </tbody> </table> <p>Model No: <b>PE9518</b> MMCX Jack To BNC Male</p>	PRICE		1-24	\$64.70	25-49	\$60.17	50-99	\$55.64	100 +	\$51.76	 <table border="1"> <thead> <tr> <th colspan="2">PRICE</th> </tr> </thead> <tbody> <tr> <td>1-24</td> <td>\$64.70</td> </tr> <tr> <td>25-49</td> <td>\$60.17</td> </tr> <tr> <td>50-99</td> <td>\$55.64</td> </tr> <tr> <td>100 +</td> <td>\$51.76</td> </tr> </tbody> </table> <p>Model No: <b>PE9516</b> MMCX Jack To BNC Female</p>	PRICE		1-24	\$64.70	25-49	\$60.17	50-99	\$55.64	100 +	\$51.76	<p><b>MCX In-Series</b></p> <p>→</p>	 <table border="1"> <thead> <tr> <th colspan="2">PRICE</th> </tr> </thead> <tbody> <tr> <td>1-24</td> <td>\$47.12</td> </tr> <tr> <td>25-49</td> <td>\$43.82</td> </tr> <tr> <td>50-99</td> <td>\$40.52</td> </tr> <tr> <td>100 +</td> <td>\$37.70</td> </tr> </tbody> </table> <p>Model No: <b>PE9479</b> MCX Plug To MCX Jack</p>	PRICE		1-24	\$47.12	25-49	\$43.82	50-99	\$40.52	100 +	\$37.70										
PRICE																																												
1-24	\$64.70																																											
25-49	\$60.17																																											
50-99	\$55.64																																											
100 +	\$51.76																																											
PRICE																																												
1-24	\$64.70																																											
25-49	\$60.17																																											
50-99	\$55.64																																											
100 +	\$51.76																																											
PRICE																																												
1-24	\$47.12																																											
25-49	\$43.82																																											
50-99	\$40.52																																											
100 +	\$37.70																																											
6	 <table border="1"> <thead> <tr> <th colspan="2">PRICE</th> </tr> </thead> <tbody> <tr> <td>1-24</td> <td>\$11.70</td> </tr> <tr> <td>25-49</td> <td>\$10.88</td> </tr> <tr> <td>50-99</td> <td>\$10.06</td> </tr> <tr> <td>100 +</td> <td>\$9.36</td> </tr> </tbody> </table> <p>Model No: <b>PE9524</b> MCX Jack To MCX Jack</p>	PRICE		1-24	\$11.70	25-49	\$10.88	50-99	\$10.06	100 +	\$9.36	 <table border="1"> <thead> <tr> <th colspan="2">PRICE</th> </tr> </thead> <tbody> <tr> <td>1-24</td> <td>\$15.05</td> </tr> <tr> <td>25-49</td> <td>\$14.00</td> </tr> <tr> <td>50-99</td> <td>\$12.94</td> </tr> <tr> <td>100 +</td> <td>\$12.04</td> </tr> </tbody> </table> <p>Model No: <b>PE9474</b> MCX Jack To MCX Jack Bulkhead Mounting Hole B01</p>	PRICE		1-24	\$15.05	25-49	\$14.00	50-99	\$12.94	100 +	\$12.04	<p><b>MCX Between-Series</b></p> <p>→</p>	 <table border="1"> <thead> <tr> <th colspan="2">PRICE</th> </tr> </thead> <tbody> <tr> <td>1-24</td> <td>\$46.71</td> </tr> <tr> <td>25-49</td> <td>\$43.44</td> </tr> <tr> <td>50-99</td> <td>\$40.17</td> </tr> <tr> <td>100 +</td> <td>\$37.37</td> </tr> </tbody> </table> <p>Model No: <b>PE9469</b> MCX Plug To BNC Male</p>	PRICE		1-24	\$46.71	25-49	\$43.44	50-99	\$40.17	100 +	\$37.37										
PRICE																																												
1-24	\$11.70																																											
25-49	\$10.88																																											
50-99	\$10.06																																											
100 +	\$9.36																																											
PRICE																																												
1-24	\$15.05																																											
25-49	\$14.00																																											
50-99	\$12.94																																											
100 +	\$12.04																																											
PRICE																																												
1-24	\$46.71																																											
25-49	\$43.44																																											
50-99	\$40.17																																											
100 +	\$37.37																																											















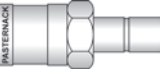
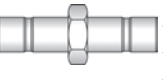
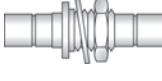

Adapters

See Our Website For Real-Time Stock Availability!

# ADAPTERS

See Adapter Locator on Pages 140-145 or the Adapter Matrix on Pages 138-139

See Page 246 for Mounting Holes

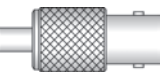
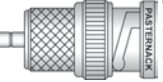
	A	B	C	D																																								
1	 <table border="1"> <thead> <tr> <th colspan="2">PRICE</th> </tr> </thead> <tbody> <tr> <td>1-24</td> <td>\$57.81</td> </tr> <tr> <td>25-49</td> <td>\$53.76</td> </tr> <tr> <td>50-99</td> <td>\$49.72</td> </tr> <tr> <td>100 +</td> <td>\$46.25</td> </tr> </tbody> </table> <p><b>Model No: PE9467</b> MCX Plug To BNC Female</p>	PRICE		1-24	\$57.81	25-49	\$53.76	50-99	\$49.72	100 +	\$46.25	 <table border="1"> <thead> <tr> <th colspan="2">PRICE</th> </tr> </thead> <tbody> <tr> <td>1-24</td> <td>\$52.03</td> </tr> <tr> <td>25-49</td> <td>\$48.39</td> </tr> <tr> <td>50-99</td> <td>\$44.75</td> </tr> <tr> <td>100 +</td> <td>\$41.62</td> </tr> </tbody> </table> <p><b>Model No: PE9468</b> MCX Jack To BNC Male</p>	PRICE		1-24	\$52.03	25-49	\$48.39	50-99	\$44.75	100 +	\$41.62	 <table border="1"> <thead> <tr> <th colspan="2">PRICE</th> </tr> </thead> <tbody> <tr> <td>1-24</td> <td>\$58.87</td> </tr> <tr> <td>25-49</td> <td>\$54.75</td> </tr> <tr> <td>50-99</td> <td>\$50.63</td> </tr> <tr> <td>100 +</td> <td>\$47.10</td> </tr> </tbody> </table> <p><b>Model No: PE9466</b> MCX Jack To BNC Female</p>	PRICE		1-24	\$58.87	25-49	\$54.75	50-99	\$50.63	100 +	\$47.10	 <table border="1"> <thead> <tr> <th colspan="2">PRICE</th> </tr> </thead> <tbody> <tr> <td>1-24</td> <td>\$64.70</td> </tr> <tr> <td>25-49</td> <td>\$60.17</td> </tr> <tr> <td>50-99</td> <td>\$55.64</td> </tr> <tr> <td>100 +</td> <td>\$51.76</td> </tr> </tbody> </table> <p><b>Model No: PE9520</b> MCX Jack Bulkhead To BNC Female Mounting Hole B04</p>	PRICE		1-24	\$64.70	25-49	\$60.17	50-99	\$55.64	100 +	\$51.76
	PRICE																																											
1-24	\$57.81																																											
25-49	\$53.76																																											
50-99	\$49.72																																											
100 +	\$46.25																																											
PRICE																																												
1-24	\$52.03																																											
25-49	\$48.39																																											
50-99	\$44.75																																											
100 +	\$41.62																																											
PRICE																																												
1-24	\$58.87																																											
25-49	\$54.75																																											
50-99	\$50.63																																											
100 +	\$47.10																																											
PRICE																																												
1-24	\$64.70																																											
25-49	\$60.17																																											
50-99	\$55.64																																											
100 +	\$51.76																																											
2	<p><b>SMB In-Series</b></p> <p>→</p>	 <table border="1"> <thead> <tr> <th colspan="2">PRICE</th> </tr> </thead> <tbody> <tr> <td>1-24</td> <td>\$23.15</td> </tr> <tr> <td>25-49</td> <td>\$21.53</td> </tr> <tr> <td>50-99</td> <td>\$19.91</td> </tr> <tr> <td>100 +</td> <td>\$18.52</td> </tr> </tbody> </table> <p><b>Model No: PE9118</b> SMB Plug To SMB Plug</p>	PRICE		1-24	\$23.15	25-49	\$21.53	50-99	\$19.91	100 +	\$18.52	 <table border="1"> <thead> <tr> <th colspan="2">PRICE</th> </tr> </thead> <tbody> <tr> <td>1-24</td> <td>\$33.08</td> </tr> <tr> <td>25-49</td> <td>\$30.76</td> </tr> <tr> <td>50-99</td> <td>\$28.45</td> </tr> <tr> <td>100 +</td> <td>\$26.46</td> </tr> </tbody> </table> <p><b>Model No: PE9120</b> SMB Plug To SMB Jack</p>	PRICE		1-24	\$33.08	25-49	\$30.76	50-99	\$28.45	100 +	\$26.46	 <table border="1"> <thead> <tr> <th colspan="2">PRICE</th> </tr> </thead> <tbody> <tr> <td>1-24</td> <td>\$20.52</td> </tr> <tr> <td>25-49</td> <td>\$19.08</td> </tr> <tr> <td>50-99</td> <td>\$17.65</td> </tr> <tr> <td>100 +</td> <td>\$16.42</td> </tr> </tbody> </table> <p><b>Model No: PE9116</b> SMB Jack To SMB Jack</p>	PRICE		1-24	\$20.52	25-49	\$19.08	50-99	\$17.65	100 +	\$16.42										
	PRICE																																											
1-24	\$23.15																																											
25-49	\$21.53																																											
50-99	\$19.91																																											
100 +	\$18.52																																											
PRICE																																												
1-24	\$33.08																																											
25-49	\$30.76																																											
50-99	\$28.45																																											
100 +	\$26.46																																											
PRICE																																												
1-24	\$20.52																																											
25-49	\$19.08																																											
50-99	\$17.65																																											
100 +	\$16.42																																											
3	 <table border="1"> <thead> <tr> <th colspan="2">PRICE</th> </tr> </thead> <tbody> <tr> <td>1-24</td> <td>\$24.17</td> </tr> <tr> <td>25-49</td> <td>\$22.48</td> </tr> <tr> <td>50-99</td> <td>\$20.79</td> </tr> <tr> <td>100 +</td> <td>\$19.34</td> </tr> </tbody> </table> <p><b>Model No: PE9122</b> SMB Jack To SMB Jack Bulkhead Mounting Hole B01</p>	PRICE		1-24	\$24.17	25-49	\$22.48	50-99	\$20.79	100 +	\$19.34	 <table border="1"> <thead> <tr> <th colspan="2">PRICE</th> </tr> </thead> <tbody> <tr> <td>1-24</td> <td>\$47.12</td> </tr> <tr> <td>25-49</td> <td>\$43.82</td> </tr> <tr> <td>50-99</td> <td>\$40.52</td> </tr> <tr> <td>100 +</td> <td>\$37.70</td> </tr> </tbody> </table> <p><b>Model No: PE9310</b> SMB "T" Plug-Plug-Plug</p>	PRICE		1-24	\$47.12	25-49	\$43.82	50-99	\$40.52	100 +	\$37.70	 <table border="1"> <thead> <tr> <th colspan="2">PRICE</th> </tr> </thead> <tbody> <tr> <td>1-24</td> <td>\$27.76</td> </tr> <tr> <td>25-49</td> <td>\$25.82</td> </tr> <tr> <td>50-99</td> <td>\$23.87</td> </tr> <tr> <td>100 +</td> <td>\$22.21</td> </tr> </tbody> </table> <p><b>Model No: PE9243</b> SMB "T" Jack-Plug-Jack</p>	PRICE		1-24	\$27.76	25-49	\$25.82	50-99	\$23.87	100 +	\$22.21	 <table border="1"> <thead> <tr> <th colspan="2">PRICE</th> </tr> </thead> <tbody> <tr> <td>1-24</td> <td>\$52.03</td> </tr> <tr> <td>25-49</td> <td>\$48.39</td> </tr> <tr> <td>50-99</td> <td>\$44.75</td> </tr> <tr> <td>100 +</td> <td>\$41.62</td> </tr> </tbody> </table> <p><b>Model No: PE9309</b> SMB "T" Plug-Jack-Jack</p>	PRICE		1-24	\$52.03	25-49	\$48.39	50-99	\$44.75	100 +	\$41.62
	PRICE																																											
1-24	\$24.17																																											
25-49	\$22.48																																											
50-99	\$20.79																																											
100 +	\$19.34																																											
PRICE																																												
1-24	\$47.12																																											
25-49	\$43.82																																											
50-99	\$40.52																																											
100 +	\$37.70																																											
PRICE																																												
1-24	\$27.76																																											
25-49	\$25.82																																											
50-99	\$23.87																																											
100 +	\$22.21																																											
PRICE																																												
1-24	\$52.03																																											
25-49	\$48.39																																											
50-99	\$44.75																																											
100 +	\$41.62																																											
4	 <table border="1"> <thead> <tr> <th colspan="2">PRICE</th> </tr> </thead> <tbody> <tr> <td>1-24</td> <td>\$33.79</td> </tr> <tr> <td>25-49</td> <td>\$31.42</td> </tr> <tr> <td>50-99</td> <td>\$29.06</td> </tr> <tr> <td>100 +</td> <td>\$27.03</td> </tr> </tbody> </table> <p><b>Model No: PE9302</b> SMB "T" Jack-Jack-Jack</p>	PRICE		1-24	\$33.79	25-49	\$31.42	50-99	\$29.06	100 +	\$27.03	<p><b>SMB Between-Series</b></p> <p>→</p>	 <table border="1"> <thead> <tr> <th colspan="2">PRICE</th> </tr> </thead> <tbody> <tr> <td>1-24</td> <td>\$38.71</td> </tr> <tr> <td>25-49</td> <td>\$36.00</td> </tr> <tr> <td>50-99</td> <td>\$33.29</td> </tr> <tr> <td>100 +</td> <td>\$30.97</td> </tr> </tbody> </table> <p><b>Model No: PE9135</b> SMB Plug To BNC Male</p>	PRICE		1-24	\$38.71	25-49	\$36.00	50-99	\$33.29	100 +	\$30.97	 <table border="1"> <thead> <tr> <th colspan="2">PRICE</th> </tr> </thead> <tbody> <tr> <td>1-24</td> <td>\$41.54</td> </tr> <tr> <td>25-49</td> <td>\$38.63</td> </tr> <tr> <td>50-99</td> <td>\$35.72</td> </tr> <tr> <td>100 +</td> <td>\$33.23</td> </tr> </tbody> </table> <p><b>Model No: PE9137</b> SMB Plug To BNC Female</p>	PRICE		1-24	\$41.54	25-49	\$38.63	50-99	\$35.72	100 +	\$33.23										
	PRICE																																											
1-24	\$33.79																																											
25-49	\$31.42																																											
50-99	\$29.06																																											
100 +	\$27.03																																											
PRICE																																												
1-24	\$38.71																																											
25-49	\$36.00																																											
50-99	\$33.29																																											
100 +	\$30.97																																											
PRICE																																												
1-24	\$41.54																																											
25-49	\$38.63																																											
50-99	\$35.72																																											
100 +	\$33.23																																											
5	 <table border="1"> <thead> <tr> <th colspan="2">PRICE</th> </tr> </thead> <tbody> <tr> <td>1-24</td> <td>\$34.35</td> </tr> <tr> <td>25-49</td> <td>\$31.95</td> </tr> <tr> <td>50-99</td> <td>\$29.54</td> </tr> <tr> <td>100 +</td> <td>\$27.48</td> </tr> </tbody> </table> <p><b>Model No: PE9241</b> SMB Plug Bulkhead To BNC Female Mounting Hole B05</p>	PRICE		1-24	\$34.35	25-49	\$31.95	50-99	\$29.54	100 +	\$27.48	 <table border="1"> <thead> <tr> <th colspan="2">PRICE</th> </tr> </thead> <tbody> <tr> <td>1-24</td> <td>\$39.42</td> </tr> <tr> <td>25-49</td> <td>\$36.66</td> </tr> <tr> <td>50-99</td> <td>\$33.90</td> </tr> <tr> <td>100 +</td> <td>\$31.54</td> </tr> </tbody> </table> <p><b>Model No: PE9132</b> SMB Jack To BNC Male</p>	PRICE		1-24	\$39.42	25-49	\$36.66	50-99	\$33.90	100 +	\$31.54	 <table border="1"> <thead> <tr> <th colspan="2">PRICE</th> </tr> </thead> <tbody> <tr> <td>1-24</td> <td>\$40.81</td> </tr> <tr> <td>25-49</td> <td>\$37.95</td> </tr> <tr> <td>50-99</td> <td>\$35.10</td> </tr> <tr> <td>100 +</td> <td>\$32.65</td> </tr> </tbody> </table> <p><b>Model No: PE9136</b> SMB Jack To BNC Female</p>	PRICE		1-24	\$40.81	25-49	\$37.95	50-99	\$35.10	100 +	\$32.65	 <table border="1"> <thead> <tr> <th colspan="2">PRICE</th> </tr> </thead> <tbody> <tr> <td>1-24</td> <td>\$37.14</td> </tr> <tr> <td>25-49</td> <td>\$34.54</td> </tr> <tr> <td>50-99</td> <td>\$31.94</td> </tr> <tr> <td>100 +</td> <td>\$29.71</td> </tr> </tbody> </table> <p><b>Model No: PE9240</b> SMB Jack Bulkhead To BNC Female Mounting Hole B05</p>	PRICE		1-24	\$37.14	25-49	\$34.54	50-99	\$31.94	100 +	\$29.71
	PRICE																																											
1-24	\$34.35																																											
25-49	\$31.95																																											
50-99	\$29.54																																											
100 +	\$27.48																																											
PRICE																																												
1-24	\$39.42																																											
25-49	\$36.66																																											
50-99	\$33.90																																											
100 +	\$31.54																																											
PRICE																																												
1-24	\$40.81																																											
25-49	\$37.95																																											
50-99	\$35.10																																											
100 +	\$32.65																																											
PRICE																																												
1-24	\$37.14																																											
25-49	\$34.54																																											
50-99	\$31.94																																											
100 +	\$29.71																																											
6	<p><b>SSMB Between-Series</b></p> <p>→</p>	 <table border="1"> <thead> <tr> <th colspan="2">PRICE</th> </tr> </thead> <tbody> <tr> <td>1-24</td> <td>\$58.87</td> </tr> <tr> <td>25-49</td> <td>\$54.75</td> </tr> <tr> <td>50-99</td> <td>\$50.63</td> </tr> <tr> <td>100 +</td> <td>\$47.10</td> </tr> </tbody> </table> <p><b>Model No: PE9393</b> SSMB Plug To BNC Male</p>	PRICE		1-24	\$58.87	25-49	\$54.75	50-99	\$50.63	100 +	\$47.10	 <table border="1"> <thead> <tr> <th colspan="2">PRICE</th> </tr> </thead> <tbody> <tr> <td>1-24</td> <td>\$58.87</td> </tr> <tr> <td>25-49</td> <td>\$54.75</td> </tr> <tr> <td>50-99</td> <td>\$50.63</td> </tr> <tr> <td>100 +</td> <td>\$47.10</td> </tr> </tbody> </table> <p><b>Model No: PE9395</b> SSMB Plug To BNC Female</p>	PRICE		1-24	\$58.87	25-49	\$54.75	50-99	\$50.63	100 +	\$47.10	 <table border="1"> <thead> <tr> <th colspan="2">PRICE</th> </tr> </thead> <tbody> <tr> <td>1-24</td> <td>\$58.87</td> </tr> <tr> <td>25-49</td> <td>\$54.75</td> </tr> <tr> <td>50-99</td> <td>\$50.63</td> </tr> <tr> <td>100 +</td> <td>\$47.10</td> </tr> </tbody> </table> <p><b>Model No: PE9392</b> SSMB Jack To BNC Male</p>	PRICE		1-24	\$58.87	25-49	\$54.75	50-99	\$50.63	100 +	\$47.10										
	PRICE																																											
1-24	\$58.87																																											
25-49	\$54.75																																											
50-99	\$50.63																																											
100 +	\$47.10																																											
PRICE																																												
1-24	\$58.87																																											
25-49	\$54.75																																											
50-99	\$50.63																																											
100 +	\$47.10																																											
PRICE																																												
1-24	\$58.87																																											
25-49	\$54.75																																											
50-99	\$50.63																																											
100 +	\$47.10																																											











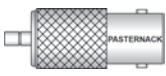

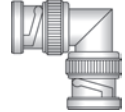
Adapters

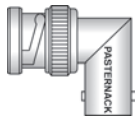
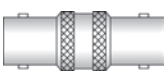
See Our Website For Real-Time Stock Availability!

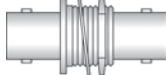
# ADAPTERS

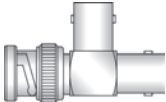
See Adapter Locator on Pages 140-145 or the Adapter Matrix on Pages 138-139

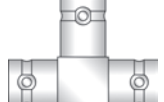
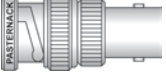
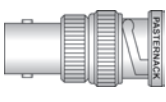
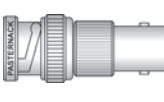
See Page 246 for Mounting Holes

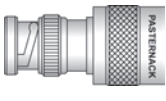
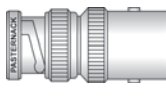
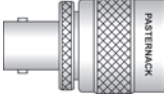
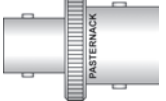
	A	B	C	D																																								
1	 <table border="1"> <thead> <tr> <th colspan="2">PRICE</th> </tr> </thead> <tbody> <tr> <td>1-24</td> <td>\$61.91</td> </tr> <tr> <td>25-49</td> <td>\$57.58</td> </tr> <tr> <td>50-99</td> <td>\$53.24</td> </tr> <tr> <td>100 +</td> <td>\$49.53</td> </tr> </tbody> </table> <p><b>Model No: PE9394</b> SSMB Jack To BNC Female</p>	PRICE		1-24	\$61.91	25-49	\$57.58	50-99	\$53.24	100 +	\$49.53	<p style="text-align: center;"><b>BNC In-Series</b></p> <p style="text-align: center;">→</p>	 <table border="1"> <thead> <tr> <th colspan="2">PRICE</th> </tr> </thead> <tbody> <tr> <td>1-24</td> <td>\$11.60</td> </tr> <tr> <td>25-49</td> <td>\$10.79</td> </tr> <tr> <td>50-99</td> <td>\$9.98</td> </tr> <tr> <td>100 +</td> <td>\$9.28</td> </tr> </tbody> </table> <p><b>Model No: PE9000</b> BNC Male To BNC Male</p>	PRICE		1-24	\$11.60	25-49	\$10.79	50-99	\$9.98	100 +	\$9.28	 <table border="1"> <thead> <tr> <th colspan="2">PRICE</th> </tr> </thead> <tbody> <tr> <td>1-24</td> <td>\$34.71</td> </tr> <tr> <td>25-49</td> <td>\$32.28</td> </tr> <tr> <td>50-99</td> <td>\$29.85</td> </tr> <tr> <td>100 +</td> <td>\$27.77</td> </tr> </tbody> </table> <p><b>Model No: PE9758</b> BNC Male To BNC Male Right Angle</p>	PRICE		1-24	\$34.71	25-49	\$32.28	50-99	\$29.85	100 +	\$27.77										
	PRICE																																											
	1-24	\$61.91																																										
	25-49	\$57.58																																										
	50-99	\$53.24																																										
	100 +	\$49.53																																										
PRICE																																												
1-24	\$11.60																																											
25-49	\$10.79																																											
50-99	\$9.98																																											
100 +	\$9.28																																											
PRICE																																												
1-24	\$34.71																																											
25-49	\$32.28																																											
50-99	\$29.85																																											
100 +	\$27.77																																											
2	 <table border="1"> <thead> <tr> <th colspan="2">PRICE</th> </tr> </thead> <tbody> <tr> <td>1-24</td> <td>\$16.10</td> </tr> <tr> <td>25-49</td> <td>\$14.97</td> </tr> <tr> <td>50-99</td> <td>\$13.85</td> </tr> <tr> <td>100 +</td> <td>\$12.88</td> </tr> </tbody> </table> <p><b>Model No: PE9269</b> BNC Male To BNC Female</p>	PRICE		1-24	\$16.10	25-49	\$14.97	50-99	\$13.85	100 +	\$12.88	 <table border="1"> <thead> <tr> <th colspan="2">PRICE</th> </tr> </thead> <tbody> <tr> <td>1-24</td> <td>\$13.58</td> </tr> <tr> <td>25-49</td> <td>\$12.63</td> </tr> <tr> <td>50-99</td> <td>\$11.68</td> </tr> <tr> <td>100 +</td> <td>\$10.86</td> </tr> </tbody> </table> <p><b>Model No: PE9085</b> BNC Male To BNC Female Right Angle</p>	PRICE		1-24	\$13.58	25-49	\$12.63	50-99	\$11.68	100 +	\$10.86	 <table border="1"> <thead> <tr> <th colspan="2">PRICE</th> </tr> </thead> <tbody> <tr> <td>1-24</td> <td>\$7.24</td> </tr> <tr> <td>25-49</td> <td>\$6.73</td> </tr> <tr> <td>50-99</td> <td>\$6.23</td> </tr> <tr> <td>100 +</td> <td>\$5.79</td> </tr> </tbody> </table> <p><b>Model No: PE9084</b> BNC Female To BNC Female</p>	PRICE		1-24	\$7.24	25-49	\$6.73	50-99	\$6.23	100 +	\$5.79	 <table border="1"> <thead> <tr> <th colspan="2">PRICE</th> </tr> </thead> <tbody> <tr> <td>1-24</td> <td>\$12.54</td> </tr> <tr> <td>25-49</td> <td>\$11.66</td> </tr> <tr> <td>50-99</td> <td>\$10.78</td> </tr> <tr> <td>100 +</td> <td>\$10.03</td> </tr> </tbody> </table> <p><b>Model No: PE9093</b> BNC Female To BNC Female Bulkhead, Hermetically Sealed Mounting Hole B06</p>	PRICE		1-24	\$12.54	25-49	\$11.66	50-99	\$10.78	100 +	\$10.03
	PRICE																																											
	1-24	\$16.10																																										
	25-49	\$14.97																																										
	50-99	\$13.85																																										
	100 +	\$12.88																																										
PRICE																																												
1-24	\$13.58																																											
25-49	\$12.63																																											
50-99	\$11.68																																											
100 +	\$10.86																																											
PRICE																																												
1-24	\$7.24																																											
25-49	\$6.73																																											
50-99	\$6.23																																											
100 +	\$5.79																																											
PRICE																																												
1-24	\$12.54																																											
25-49	\$11.66																																											
50-99	\$10.78																																											
100 +	\$10.03																																											
3	 <table border="1"> <thead> <tr> <th colspan="2">PRICE</th> </tr> </thead> <tbody> <tr> <td>1-24</td> <td>\$43.27</td> </tr> <tr> <td>25-49</td> <td>\$40.24</td> </tr> <tr> <td>50-99</td> <td>\$37.21</td> </tr> <tr> <td>100 +</td> <td>\$34.62</td> </tr> </tbody> </table> <p><b>Model No: PE9420</b> BNC Female To BNC Female Bulkhead, Hermetically Sealed 1" Max Panel Mounting Hole B06</p>	PRICE		1-24	\$43.27	25-49	\$40.24	50-99	\$37.21	100 +	\$34.62	 <table border="1"> <thead> <tr> <th colspan="2">PRICE</th> </tr> </thead> <tbody> <tr> <td>1-24</td> <td>\$19.40</td> </tr> <tr> <td>25-49</td> <td>\$18.04</td> </tr> <tr> <td>50-99</td> <td>\$16.68</td> </tr> <tr> <td>100 +</td> <td>\$15.52</td> </tr> </tbody> </table> <p><b>Model No: PE9172</b> BNC Female To BNC Female Bulkhead, Isolated Ground Mounting Hole B06</p>	PRICE		1-24	\$19.40	25-49	\$18.04	50-99	\$16.68	100 +	\$15.52	 <table border="1"> <thead> <tr> <th colspan="2">PRICE</th> </tr> </thead> <tbody> <tr> <td>1-24</td> <td>\$11.38</td> </tr> <tr> <td>25-49</td> <td>\$10.58</td> </tr> <tr> <td>50-99</td> <td>\$9.79</td> </tr> <tr> <td>100 +</td> <td>\$9.10</td> </tr> </tbody> </table> <p><b>Model No: PE9106</b> BNC Female To BNC Female Panel Mount Mounting Hole A03</p>	PRICE		1-24	\$11.38	25-49	\$10.58	50-99	\$9.79	100 +	\$9.10	 <table border="1"> <thead> <tr> <th colspan="2">PRICE</th> </tr> </thead> <tbody> <tr> <td>1-24</td> <td>\$14.90</td> </tr> <tr> <td>25-49</td> <td>\$13.86</td> </tr> <tr> <td>50-99</td> <td>\$12.81</td> </tr> <tr> <td>100 +</td> <td>\$11.92</td> </tr> </tbody> </table> <p><b>Model No: PE9001</b> BNC "T" Female-Male-Female</p>	PRICE		1-24	\$14.90	25-49	\$13.86	50-99	\$12.81	100 +	\$11.92
	PRICE																																											
	1-24	\$43.27																																										
	25-49	\$40.24																																										
	50-99	\$37.21																																										
	100 +	\$34.62																																										
PRICE																																												
1-24	\$19.40																																											
25-49	\$18.04																																											
50-99	\$16.68																																											
100 +	\$15.52																																											
PRICE																																												
1-24	\$11.38																																											
25-49	\$10.58																																											
50-99	\$9.79																																											
100 +	\$9.10																																											
PRICE																																												
1-24	\$14.90																																											
25-49	\$13.86																																											
50-99	\$12.81																																											
100 +	\$11.92																																											
4	 <table border="1"> <thead> <tr> <th colspan="2">PRICE</th> </tr> </thead> <tbody> <tr> <td>1-24</td> <td>\$37.55</td> </tr> <tr> <td>25-49</td> <td>\$34.92</td> </tr> <tr> <td>50-99</td> <td>\$32.29</td> </tr> <tr> <td>100 +</td> <td>\$30.04</td> </tr> </tbody> </table> <p><b>Model No: PE9174</b> BNC "T" Male-Female-Female</p>	PRICE		1-24	\$37.55	25-49	\$34.92	50-99	\$32.29	100 +	\$30.04	 <table border="1"> <thead> <tr> <th colspan="2">PRICE</th> </tr> </thead> <tbody> <tr> <td>1-24</td> <td>\$34.98</td> </tr> <tr> <td>25-49</td> <td>\$32.53</td> </tr> <tr> <td>50-99</td> <td>\$30.08</td> </tr> <tr> <td>100 +</td> <td>\$27.98</td> </tr> </tbody> </table> <p><b>Model No: PE9484</b> BNC "Y" Female-Male-Female</p>	PRICE		1-24	\$34.98	25-49	\$32.53	50-99	\$30.08	100 +	\$27.98	 <table border="1"> <thead> <tr> <th colspan="2">PRICE</th> </tr> </thead> <tbody> <tr> <td>1-24</td> <td>\$17.48</td> </tr> <tr> <td>25-49</td> <td>\$16.26</td> </tr> <tr> <td>50-99</td> <td>\$15.03</td> </tr> <tr> <td>100 +</td> <td>\$13.98</td> </tr> </tbody> </table> <p><b>Model No: PE9003</b> BNC "T" Female-Female-Female</p>	PRICE		1-24	\$17.48	25-49	\$16.26	50-99	\$15.03	100 +	\$13.98	 <table border="1"> <thead> <tr> <th colspan="2">PRICE</th> </tr> </thead> <tbody> <tr> <td>1-24</td> <td>\$29.84</td> </tr> <tr> <td>25-49</td> <td>\$27.75</td> </tr> <tr> <td>50-99</td> <td>\$25.66</td> </tr> <tr> <td>100 +</td> <td>\$23.87</td> </tr> </tbody> </table> <p><b>Model No: PE9530</b> Standard BNC Male To Reverse Polarity BNC Female</p>	PRICE		1-24	\$29.84	25-49	\$27.75	50-99	\$25.66	100 +	\$23.87
	PRICE																																											
	1-24	\$37.55																																										
	25-49	\$34.92																																										
	50-99	\$32.29																																										
	100 +	\$30.04																																										
PRICE																																												
1-24	\$34.98																																											
25-49	\$32.53																																											
50-99	\$30.08																																											
100 +	\$27.98																																											
PRICE																																												
1-24	\$17.48																																											
25-49	\$16.26																																											
50-99	\$15.03																																											
100 +	\$13.98																																											
PRICE																																												
1-24	\$29.84																																											
25-49	\$27.75																																											
50-99	\$25.66																																											
100 +	\$23.87																																											
5	 <table border="1"> <thead> <tr> <th colspan="2">PRICE</th> </tr> </thead> <tbody> <tr> <td>1-24</td> <td>\$29.08</td> </tr> <tr> <td>25-49</td> <td>\$27.04</td> </tr> <tr> <td>50-99</td> <td>\$25.01</td> </tr> <tr> <td>100 +</td> <td>\$23.26</td> </tr> </tbody> </table> <p><b>Model No: PE9529</b> Standard BNC Female To Reverse Polarity BNC Male</p>	PRICE		1-24	\$29.08	25-49	\$27.04	50-99	\$25.01	100 +	\$23.26	<p style="text-align: center;"><b>BNC Between-Series</b></p> <p style="text-align: center;">→</p>	 <table border="1"> <thead> <tr> <th colspan="2">PRICE</th> </tr> </thead> <tbody> <tr> <td>1-24</td> <td>\$77.92</td> </tr> <tr> <td>25-49</td> <td>\$72.47</td> </tr> <tr> <td>50-99</td> <td>\$67.01</td> </tr> <tr> <td>100 +</td> <td>\$62.34</td> </tr> </tbody> </table> <p><b>Model No: PE9406</b> BNC Male To MHV Female</p>	PRICE		1-24	\$77.92	25-49	\$72.47	50-99	\$67.01	100 +	\$62.34	 <table border="1"> <thead> <tr> <th colspan="2">PRICE</th> </tr> </thead> <tbody> <tr> <td>1-24</td> <td>\$31.06</td> </tr> <tr> <td>25-49</td> <td>\$28.89</td> </tr> <tr> <td>50-99</td> <td>\$26.71</td> </tr> <tr> <td>100 +</td> <td>\$24.85</td> </tr> </tbody> </table> <p><b>Model No: PE9297</b> BNC Female To MHV Male</p>	PRICE		1-24	\$31.06	25-49	\$28.89	50-99	\$26.71	100 +	\$24.85										
	PRICE																																											
	1-24	\$29.08																																										
	25-49	\$27.04																																										
	50-99	\$25.01																																										
	100 +	\$23.26																																										
PRICE																																												
1-24	\$77.92																																											
25-49	\$72.47																																											
50-99	\$67.01																																											
100 +	\$62.34																																											
PRICE																																												
1-24	\$31.06																																											
25-49	\$28.89																																											
50-99	\$26.71																																											
100 +	\$24.85																																											
6	 <table border="1"> <thead> <tr> <th colspan="2">PRICE</th> </tr> </thead> <tbody> <tr> <td>1-24</td> <td>\$47.12</td> </tr> <tr> <td>25-49</td> <td>\$43.82</td> </tr> <tr> <td>50-99</td> <td>\$40.52</td> </tr> <tr> <td>100 +</td> <td>\$37.70</td> </tr> </tbody> </table> <p><b>Model No: PE9536</b> BNC Male To C Male</p>	PRICE		1-24	\$47.12	25-49	\$43.82	50-99	\$40.52	100 +	\$37.70	 <table border="1"> <thead> <tr> <th colspan="2">PRICE</th> </tr> </thead> <tbody> <tr> <td>1-24</td> <td>\$37.39</td> </tr> <tr> <td>25-49</td> <td>\$34.77</td> </tr> <tr> <td>50-99</td> <td>\$32.16</td> </tr> <tr> <td>100 +</td> <td>\$29.91</td> </tr> </tbody> </table> <p><b>Model No: PE9109</b> BNC Male To C Female</p>	PRICE		1-24	\$37.39	25-49	\$34.77	50-99	\$32.16	100 +	\$29.91	 <table border="1"> <thead> <tr> <th colspan="2">PRICE</th> </tr> </thead> <tbody> <tr> <td>1-24</td> <td>\$27.76</td> </tr> <tr> <td>25-49</td> <td>\$25.82</td> </tr> <tr> <td>50-99</td> <td>\$23.87</td> </tr> <tr> <td>100 +</td> <td>\$22.21</td> </tr> </tbody> </table> <p><b>Model No: PE9087</b> BNC Female To C Male</p>	PRICE		1-24	\$27.76	25-49	\$25.82	50-99	\$23.87	100 +	\$22.21	 <table border="1"> <thead> <tr> <th colspan="2">PRICE</th> </tr> </thead> <tbody> <tr> <td>1-24</td> <td>\$47.12</td> </tr> <tr> <td>25-49</td> <td>\$43.82</td> </tr> <tr> <td>50-99</td> <td>\$40.52</td> </tr> <tr> <td>100 +</td> <td>\$37.70</td> </tr> </tbody> </table> <p><b>Model No: PE9537</b> BNC Female To C Female</p>	PRICE		1-24	\$47.12	25-49	\$43.82	50-99	\$40.52	100 +	\$37.70
	PRICE																																											
	1-24	\$47.12																																										
	25-49	\$43.82																																										
	50-99	\$40.52																																										
	100 +	\$37.70																																										
PRICE																																												
1-24	\$37.39																																											
25-49	\$34.77																																											
50-99	\$32.16																																											
100 +	\$29.91																																											
PRICE																																												
1-24	\$27.76																																											
25-49	\$25.82																																											
50-99	\$23.87																																											
100 +	\$22.21																																											
PRICE																																												
1-24	\$47.12																																											
25-49	\$43.82																																											
50-99	\$40.52																																											
100 +	\$37.70																																											

Adapters











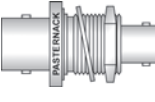
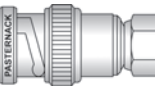
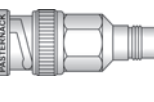
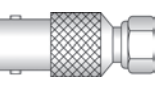

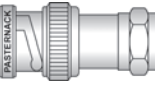

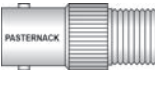
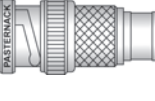

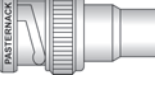

See Our Website For Real-Time Stock Availability!

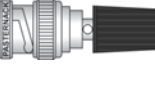

# ADAPTERS

See Adapter Locator on Pages 140-145 or the Adapter Matrix on Pages 138-139

See Page 246 for Mounting Holes

	A	B	C	D																																								
1	 <table border="1"> <thead> <tr> <th colspan="2">PRICE</th> </tr> </thead> <tbody> <tr> <td>1-24</td> <td>\$70.68</td> </tr> <tr> <td>25-49</td> <td>\$65.73</td> </tr> <tr> <td>50-99</td> <td>\$60.78</td> </tr> <tr> <td>100 +</td> <td>\$56.54</td> </tr> </tbody> </table> <p><b>Model No: PE9204</b> BNC Female To C Female Bulkhead Mounting Hole G01</p>	PRICE		1-24	\$70.68	25-49	\$65.73	50-99	\$60.78	100 +	\$56.54	 <table border="1"> <thead> <tr> <th colspan="2">PRICE</th> </tr> </thead> <tbody> <tr> <td>1-24</td> <td>\$52.94</td> </tr> <tr> <td>25-49</td> <td>\$49.23</td> </tr> <tr> <td>50-99</td> <td>\$45.53</td> </tr> <tr> <td>100 +</td> <td>\$42.35</td> </tr> </tbody> </table> <p><b>Model No: PE9234</b> BNC Male To 75 Ohm SMC Plug</p>	PRICE		1-24	\$52.94	25-49	\$49.23	50-99	\$45.53	100 +	\$42.35	 <table border="1"> <thead> <tr> <th colspan="2">PRICE</th> </tr> </thead> <tbody> <tr> <td>1-24</td> <td>\$45.45</td> </tr> <tr> <td>25-49</td> <td>\$42.27</td> </tr> <tr> <td>50-99</td> <td>\$39.09</td> </tr> <tr> <td>100 +</td> <td>\$36.36</td> </tr> </tbody> </table> <p><b>Model No: PE9233</b> BNC Male To 75 Ohm SMC Jack</p>	PRICE		1-24	\$45.45	25-49	\$42.27	50-99	\$39.09	100 +	\$36.36	 <table border="1"> <thead> <tr> <th colspan="2">PRICE</th> </tr> </thead> <tbody> <tr> <td>1-24</td> <td>\$52.94</td> </tr> <tr> <td>25-49</td> <td>\$49.23</td> </tr> <tr> <td>50-99</td> <td>\$45.53</td> </tr> <tr> <td>100 +</td> <td>\$42.35</td> </tr> </tbody> </table> <p><b>Model No: PE9236</b> BNC Female To 75 Ohm SMC Plug</p>	PRICE		1-24	\$52.94	25-49	\$49.23	50-99	\$45.53	100 +	\$42.35
	PRICE																																											
1-24	\$70.68																																											
25-49	\$65.73																																											
50-99	\$60.78																																											
100 +	\$56.54																																											
PRICE																																												
1-24	\$52.94																																											
25-49	\$49.23																																											
50-99	\$45.53																																											
100 +	\$42.35																																											
PRICE																																												
1-24	\$45.45																																											
25-49	\$42.27																																											
50-99	\$39.09																																											
100 +	\$36.36																																											
PRICE																																												
1-24	\$52.94																																											
25-49	\$49.23																																											
50-99	\$45.53																																											
100 +	\$42.35																																											
2	 <table border="1"> <thead> <tr> <th colspan="2">PRICE</th> </tr> </thead> <tbody> <tr> <td>1-24</td> <td>\$52.94</td> </tr> <tr> <td>25-49</td> <td>\$49.23</td> </tr> <tr> <td>50-99</td> <td>\$45.53</td> </tr> <tr> <td>100 +</td> <td>\$42.35</td> </tr> </tbody> </table> <p><b>Model No: PE9235</b> BNC Female To 75 Ohm SMC Jack</p>	PRICE		1-24	\$52.94	25-49	\$49.23	50-99	\$45.53	100 +	\$42.35	 <table border="1"> <thead> <tr> <th colspan="2">PRICE</th> </tr> </thead> <tbody> <tr> <td>1-24</td> <td>\$10.84</td> </tr> <tr> <td>25-49</td> <td>\$10.08</td> </tr> <tr> <td>50-99</td> <td>\$9.32</td> </tr> <tr> <td>100 +</td> <td>\$8.67</td> </tr> </tbody> </table> <p><b>Model No: PE9152</b> BNC Male To F Male</p>	PRICE		1-24	\$10.84	25-49	\$10.08	50-99	\$9.32	100 +	\$8.67	 <table border="1"> <thead> <tr> <th colspan="2">PRICE</th> </tr> </thead> <tbody> <tr> <td>1-24</td> <td>\$11.70</td> </tr> <tr> <td>25-49</td> <td>\$10.88</td> </tr> <tr> <td>50-99</td> <td>\$10.06</td> </tr> <tr> <td>100 +</td> <td>\$9.36</td> </tr> </tbody> </table> <p><b>Model No: PE9150</b> BNC Male To F Female</p>	PRICE		1-24	\$11.70	25-49	\$10.88	50-99	\$10.06	100 +	\$9.36	 <table border="1"> <thead> <tr> <th colspan="2">PRICE</th> </tr> </thead> <tbody> <tr> <td>1-24</td> <td>\$11.59</td> </tr> <tr> <td>25-49</td> <td>\$10.78</td> </tr> <tr> <td>50-99</td> <td>\$9.97</td> </tr> <tr> <td>100 +</td> <td>\$9.27</td> </tr> </tbody> </table> <p><b>Model No: PE9151</b> BNC Female To F Male</p>	PRICE		1-24	\$11.59	25-49	\$10.78	50-99	\$9.97	100 +	\$9.27
	PRICE																																											
1-24	\$52.94																																											
25-49	\$49.23																																											
50-99	\$45.53																																											
100 +	\$42.35																																											
PRICE																																												
1-24	\$10.84																																											
25-49	\$10.08																																											
50-99	\$9.32																																											
100 +	\$8.67																																											
PRICE																																												
1-24	\$11.70																																											
25-49	\$10.88																																											
50-99	\$10.06																																											
100 +	\$9.36																																											
PRICE																																												
1-24	\$11.59																																											
25-49	\$10.78																																											
50-99	\$9.97																																											
100 +	\$9.27																																											
3	 <table border="1"> <thead> <tr> <th colspan="2">PRICE</th> </tr> </thead> <tbody> <tr> <td>1-24</td> <td>\$10.84</td> </tr> <tr> <td>25-49</td> <td>\$10.08</td> </tr> <tr> <td>50-99</td> <td>\$9.32</td> </tr> <tr> <td>100 +</td> <td>\$8.67</td> </tr> </tbody> </table> <p><b>Model No: PE9153</b> BNC Female To F Female</p>	PRICE		1-24	\$10.84	25-49	\$10.08	50-99	\$9.32	100 +	\$8.67	 <table border="1"> <thead> <tr> <th colspan="2">PRICE</th> </tr> </thead> <tbody> <tr> <td>1-24</td> <td>\$45.45</td> </tr> <tr> <td>25-49</td> <td>\$42.27</td> </tr> <tr> <td>50-99</td> <td>\$39.09</td> </tr> <tr> <td>100 +</td> <td>\$36.36</td> </tr> </tbody> </table> <p><b>Model No: PE9230</b> BNC Male To 75 Ohm SMB Plug</p>	PRICE		1-24	\$45.45	25-49	\$42.27	50-99	\$39.09	100 +	\$36.36	 <table border="1"> <thead> <tr> <th colspan="2">PRICE</th> </tr> </thead> <tbody> <tr> <td>1-24</td> <td>\$45.45</td> </tr> <tr> <td>25-49</td> <td>\$42.27</td> </tr> <tr> <td>50-99</td> <td>\$39.09</td> </tr> <tr> <td>100 +</td> <td>\$36.36</td> </tr> </tbody> </table> <p><b>Model No: PE9229</b> BNC Male To 75 Ohm SMB Jack</p>	PRICE		1-24	\$45.45	25-49	\$42.27	50-99	\$39.09	100 +	\$36.36	 <table border="1"> <thead> <tr> <th colspan="2">PRICE</th> </tr> </thead> <tbody> <tr> <td>1-24</td> <td>\$45.45</td> </tr> <tr> <td>25-49</td> <td>\$42.27</td> </tr> <tr> <td>50-99</td> <td>\$39.09</td> </tr> <tr> <td>100 +</td> <td>\$36.36</td> </tr> </tbody> </table> <p><b>Model No: PE9232</b> BNC Female To 75 Ohm SMB Plug</p>	PRICE		1-24	\$45.45	25-49	\$42.27	50-99	\$39.09	100 +	\$36.36
	PRICE																																											
1-24	\$10.84																																											
25-49	\$10.08																																											
50-99	\$9.32																																											
100 +	\$8.67																																											
PRICE																																												
1-24	\$45.45																																											
25-49	\$42.27																																											
50-99	\$39.09																																											
100 +	\$36.36																																											
PRICE																																												
1-24	\$45.45																																											
25-49	\$42.27																																											
50-99	\$39.09																																											
100 +	\$36.36																																											
PRICE																																												
1-24	\$45.45																																											
25-49	\$42.27																																											
50-99	\$39.09																																											
100 +	\$36.36																																											
4	 <table border="1"> <thead> <tr> <th colspan="2">PRICE</th> </tr> </thead> <tbody> <tr> <td>1-24</td> <td>\$45.45</td> </tr> <tr> <td>25-49</td> <td>\$42.27</td> </tr> <tr> <td>50-99</td> <td>\$39.09</td> </tr> <tr> <td>100 +</td> <td>\$36.36</td> </tr> </tbody> </table> <p><b>Model No: PE9231</b> BNC Female To 75 Ohm SMB Jack</p>	PRICE		1-24	\$45.45	25-49	\$42.27	50-99	\$39.09	100 +	\$36.36	 <table border="1"> <thead> <tr> <th colspan="2">PRICE</th> </tr> </thead> <tbody> <tr> <td>1-24</td> <td>\$10.84</td> </tr> <tr> <td>25-49</td> <td>\$10.08</td> </tr> <tr> <td>50-99</td> <td>\$9.32</td> </tr> <tr> <td>100 +</td> <td>\$8.67</td> </tr> </tbody> </table> <p><b>Model No: PE9171</b> BNC Male To RCA Jack</p>	PRICE		1-24	\$10.84	25-49	\$10.08	50-99	\$9.32	100 +	\$8.67	 <table border="1"> <thead> <tr> <th colspan="2">PRICE</th> </tr> </thead> <tbody> <tr> <td>1-24</td> <td>\$11.10</td> </tr> <tr> <td>25-49</td> <td>\$10.32</td> </tr> <tr> <td>50-99</td> <td>\$9.55</td> </tr> <tr> <td>100 +</td> <td>\$8.88</td> </tr> </tbody> </table> <p><b>Model No: PE9158</b> BNC Female To RCA Plug</p>	PRICE		1-24	\$11.10	25-49	\$10.32	50-99	\$9.55	100 +	\$8.88	 <table border="1"> <thead> <tr> <th colspan="2">PRICE</th> </tr> </thead> <tbody> <tr> <td>1-24</td> <td>\$18.09</td> </tr> <tr> <td>25-49</td> <td>\$16.82</td> </tr> <tr> <td>50-99</td> <td>\$15.56</td> </tr> <tr> <td>100 +</td> <td>\$14.47</td> </tr> </tbody> </table> <p><b>Model No: PE9009</b> BNC Male To Double Banana Plug</p>	PRICE		1-24	\$18.09	25-49	\$16.82	50-99	\$15.56	100 +	\$14.47
	PRICE																																											
1-24	\$45.45																																											
25-49	\$42.27																																											
50-99	\$39.09																																											
100 +	\$36.36																																											
PRICE																																												
1-24	\$10.84																																											
25-49	\$10.08																																											
50-99	\$9.32																																											
100 +	\$8.67																																											
PRICE																																												
1-24	\$11.10																																											
25-49	\$10.32																																											
50-99	\$9.55																																											
100 +	\$8.88																																											
PRICE																																												
1-24	\$18.09																																											
25-49	\$16.82																																											
50-99	\$15.56																																											
100 +	\$14.47																																											
5	 <table border="1"> <thead> <tr> <th colspan="2">PRICE</th> </tr> </thead> <tbody> <tr> <td>1-24</td> <td>\$18.09</td> </tr> <tr> <td>25-49</td> <td>\$16.82</td> </tr> <tr> <td>50-99</td> <td>\$15.56</td> </tr> <tr> <td>100 +</td> <td>\$14.47</td> </tr> </tbody> </table> <p><b>Model No: PE9011</b> BNC Male To Binding Posts Double</p>	PRICE		1-24	\$18.09	25-49	\$16.82	50-99	\$15.56	100 +	\$14.47	 <table border="1"> <thead> <tr> <th colspan="2">PRICE</th> </tr> </thead> <tbody> <tr> <td>1-24</td> <td>\$10.99</td> </tr> <tr> <td>25-49</td> <td>\$10.22</td> </tr> <tr> <td>50-99</td> <td>\$9.45</td> </tr> <tr> <td>100 +</td> <td>\$8.79</td> </tr> </tbody> </table> <p><b>Model No: PE9169</b> BNC Male To Single Binding Post</p>	PRICE		1-24	\$10.99	25-49	\$10.22	50-99	\$9.45	100 +	\$8.79	 <table border="1"> <thead> <tr> <th colspan="2">PRICE</th> </tr> </thead> <tbody> <tr> <td>1-24</td> <td>\$16.21</td> </tr> <tr> <td>25-49</td> <td>\$15.08</td> </tr> <tr> <td>50-99</td> <td>\$13.94</td> </tr> <tr> <td>100 +</td> <td>\$12.97</td> </tr> </tbody> </table> <p><b>Model No: PE9008</b> BNC Female To Double Banana Plug</p>	PRICE		1-24	\$16.21	25-49	\$15.08	50-99	\$13.94	100 +	\$12.97	 <table border="1"> <thead> <tr> <th colspan="2">PRICE</th> </tr> </thead> <tbody> <tr> <td>1-24</td> <td>\$20.06</td> </tr> <tr> <td>25-49</td> <td>\$18.66</td> </tr> <tr> <td>50-99</td> <td>\$17.25</td> </tr> <tr> <td>100 +</td> <td>\$16.05</td> </tr> </tbody> </table> <p><b>Model No: PE9175</b> BNC Female To Single Banana Plug</p>	PRICE		1-24	\$20.06	25-49	\$18.66	50-99	\$17.25	100 +	\$16.05
	PRICE																																											
1-24	\$18.09																																											
25-49	\$16.82																																											
50-99	\$15.56																																											
100 +	\$14.47																																											
PRICE																																												
1-24	\$10.99																																											
25-49	\$10.22																																											
50-99	\$9.45																																											
100 +	\$8.79																																											
PRICE																																												
1-24	\$16.21																																											
25-49	\$15.08																																											
50-99	\$13.94																																											
100 +	\$12.97																																											
PRICE																																												
1-24	\$20.06																																											
25-49	\$18.66																																											
50-99	\$17.25																																											
100 +	\$16.05																																											
6	 <table border="1"> <thead> <tr> <th colspan="2">PRICE</th> </tr> </thead> <tbody> <tr> <td>1-24</td> <td>\$18.09</td> </tr> <tr> <td>25-49</td> <td>\$16.82</td> </tr> <tr> <td>50-99</td> <td>\$15.56</td> </tr> <tr> <td>100 +</td> <td>\$14.47</td> </tr> </tbody> </table> <p><b>Model No: PE9013</b> BNC Female To Binding Posts</p>	PRICE		1-24	\$18.09	25-49	\$16.82	50-99	\$15.56	100 +	\$14.47	 <table border="1"> <thead> <tr> <th colspan="2">PRICE</th> </tr> </thead> <tbody> <tr> <td>1-24</td> <td>\$116.78</td> </tr> <tr> <td>25-49</td> <td>\$108.61</td> </tr> <tr> <td>50-99</td> <td>\$100.43</td> </tr> <tr> <td>100 +</td> <td>\$93.42</td> </tr> </tbody> </table> <p><b>Model No: PE9223</b> BNC Male To GR874</p>	PRICE		1-24	\$116.78	25-49	\$108.61	50-99	\$100.43	100 +	\$93.42	 <table border="1"> <thead> <tr> <th colspan="2">PRICE</th> </tr> </thead> <tbody> <tr> <td>1-24</td> <td>\$116.78</td> </tr> <tr> <td>25-49</td> <td>\$108.61</td> </tr> <tr> <td>50-99</td> <td>\$100.43</td> </tr> <tr> <td>100 +</td> <td>\$93.42</td> </tr> </tbody> </table> <p><b>Model No: PE9222</b> BNC Female To GR874</p>	PRICE		1-24	\$116.78	25-49	\$108.61	50-99	\$100.43	100 +	\$93.42	<div style="text-align: center;"> <p><b>MHV</b> <b>In-Series</b></p> <p>→</p> </div>										
	PRICE																																											
1-24	\$18.09																																											
25-49	\$16.82																																											
50-99	\$15.56																																											
100 +	\$14.47																																											
PRICE																																												
1-24	\$116.78																																											
25-49	\$108.61																																											
50-99	\$100.43																																											
100 +	\$93.42																																											
PRICE																																												
1-24	\$116.78																																											
25-49	\$108.61																																											
50-99	\$100.43																																											
100 +	\$93.42																																											







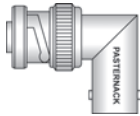
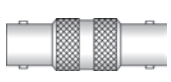
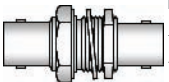

Adapters

See Our Website For Real-Time Stock Availability!

# ADAPTERS

See Adapter Locator on Pages 140-145 or the Adapter Matrix on Pages 138-139

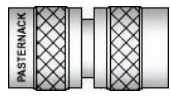
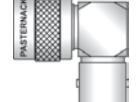
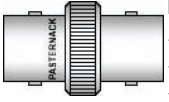

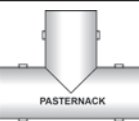
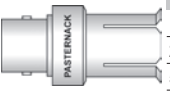







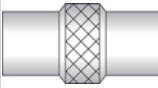
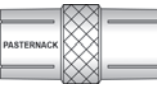
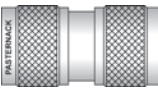

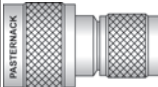
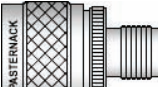

See Page 246 for Mounting Holes

	A	B	C	D																																									
1	 <table border="1"> <thead> <tr> <th colspan="2">PRICE</th> </tr> </thead> <tbody> <tr> <td>1-24</td> <td>\$45.55</td> </tr> <tr> <td>25-49</td> <td>\$42.36</td> </tr> <tr> <td>50-99</td> <td>\$39.17</td> </tr> <tr> <td>100 +</td> <td>\$36.44</td> </tr> </tbody> </table> <p>Model No: <b>PE9266</b> MHV Male To MHV Female Right Angle</p>	PRICE		1-24	\$45.55	25-49	\$42.36	50-99	\$39.17	100 +	\$36.44	 <table border="1"> <thead> <tr> <th colspan="2">PRICE</th> </tr> </thead> <tbody> <tr> <td>1-24</td> <td>\$25.38</td> </tr> <tr> <td>25-49</td> <td>\$23.60</td> </tr> <tr> <td>50-99</td> <td>\$21.83</td> </tr> <tr> <td>100 +</td> <td>\$20.30</td> </tr> </tbody> </table> <p>Model No: <b>PE9267</b> MHV Female To MHV Female</p>	PRICE		1-24	\$25.38	25-49	\$23.60	50-99	\$21.83	100 +	\$20.30	 <table border="1"> <thead> <tr> <th colspan="2">PRICE</th> </tr> </thead> <tbody> <tr> <td>1-24</td> <td>\$46.21</td> </tr> <tr> <td>25-49</td> <td>\$42.98</td> </tr> <tr> <td>50-99</td> <td>\$39.74</td> </tr> <tr> <td>100 +</td> <td>\$36.97</td> </tr> </tbody> </table> <p>Model No: <b>PE9268</b> MHV Female To MHV Female Bulkhead, Hermetically Sealed Mounting Hole B06</p>	PRICE		1-24	\$46.21	25-49	\$42.98	50-99	\$39.74	100 +	\$36.97	 <table border="1"> <thead> <tr> <th colspan="2">PRICE</th> </tr> </thead> <tbody> <tr> <td>1-24</td> <td>\$42.25</td> </tr> <tr> <td>25-49</td> <td>\$39.29</td> </tr> <tr> <td>50-99</td> <td>\$36.34</td> </tr> <tr> <td>100 +</td> <td>\$33.80</td> </tr> </tbody> </table> <p>Model No: <b>PE9211</b> MHV "T" Female-Male-Female</p>	PRICE		1-24	\$42.25	25-49	\$39.29	50-99	\$36.34	100 +	\$33.80	
PRICE																																													
1-24	\$45.55																																												
25-49	\$42.36																																												
50-99	\$39.17																																												
100 +	\$36.44																																												
PRICE																																													
1-24	\$25.38																																												
25-49	\$23.60																																												
50-99	\$21.83																																												
100 +	\$20.30																																												
PRICE																																													
1-24	\$46.21																																												
25-49	\$42.98																																												
50-99	\$39.74																																												
100 +	\$36.97																																												
PRICE																																													
1-24	\$42.25																																												
25-49	\$39.29																																												
50-99	\$36.34																																												
100 +	\$33.80																																												
2	<div style="background-color: black; color: white; padding: 10px; text-align: center;"> <h2>MHV Between-Series</h2> <p>→</p> </div>																																												
3	 <table border="1"> <thead> <tr> <th colspan="2">PRICE</th> </tr> </thead> <tbody> <tr> <td>1-24</td> <td>\$44.74</td> </tr> <tr> <td>25-49</td> <td>\$41.61</td> </tr> <tr> <td>50-99</td> <td>\$38.48</td> </tr> <tr> <td>100 +</td> <td>\$35.79</td> </tr> </tbody> </table> <p>Model No: <b>PE9339</b> MHV Female To SHV Jack</p>	PRICE		1-24	\$44.74	25-49	\$41.61	50-99	\$38.48	100 +	\$35.79	<div style="background-color: black; color: white; padding: 10px; text-align: center;"> <h2>SHV In-Series</h2> <p>→</p> </div>		 <table border="1"> <thead> <tr> <th colspan="2">PRICE</th> </tr> </thead> <tbody> <tr> <td>1-24</td> <td>\$91.05</td> </tr> <tr> <td>25-49</td> <td>\$84.68</td> </tr> <tr> <td>50-99</td> <td>\$78.30</td> </tr> <tr> <td>100 +</td> <td>\$72.84</td> </tr> </tbody> </table> <p>Model No: <b>PE9749</b> SHV Plug To SHV Jack</p>	PRICE		1-24	\$91.05	25-49	\$84.68	50-99	\$78.30	100 +	\$72.84																					
PRICE																																													
1-24	\$44.74																																												
25-49	\$41.61																																												
50-99	\$38.48																																												
100 +	\$35.79																																												
PRICE																																													
1-24	\$91.05																																												
25-49	\$84.68																																												
50-99	\$78.30																																												
100 +	\$72.84																																												
4	 <table border="1"> <thead> <tr> <th colspan="2">PRICE</th> </tr> </thead> <tbody> <tr> <td>1-24</td> <td>\$31.06</td> </tr> <tr> <td>25-49</td> <td>\$28.89</td> </tr> <tr> <td>50-99</td> <td>\$26.71</td> </tr> <tr> <td>100 +</td> <td>\$24.85</td> </tr> </tbody> </table> <p>Model No: <b>PE9337</b> SHV Jack To SHV Jack</p>	PRICE		1-24	\$31.06	25-49	\$28.89	50-99	\$26.71	100 +	\$24.85	 <table border="1"> <thead> <tr> <th colspan="2">PRICE</th> </tr> </thead> <tbody> <tr> <td>1-24</td> <td>\$64.80</td> </tr> <tr> <td>25-49</td> <td>\$60.26</td> </tr> <tr> <td>50-99</td> <td>\$55.73</td> </tr> <tr> <td>100 +</td> <td>\$51.84</td> </tr> </tbody> </table> <p>Model No: <b>PE9336</b> SHV Jack To SHV Jack Bulkhead Hermetically Sealed Mounting Hole B06</p>	PRICE		1-24	\$64.80	25-49	\$60.26	50-99	\$55.73	100 +	\$51.84	 <table border="1"> <thead> <tr> <th colspan="2">PRICE</th> </tr> </thead> <tbody> <tr> <td>1-24</td> <td>\$80.00</td> </tr> <tr> <td>25-49</td> <td>\$74.40</td> </tr> <tr> <td>50-99</td> <td>\$68.80</td> </tr> <tr> <td>100 +</td> <td>\$64.00</td> </tr> </tbody> </table> <p>Model No: <b>PE9249</b> SHV "T" Jack-Plug-Jack</p>	PRICE		1-24	\$80.00	25-49	\$74.40	50-99	\$68.80	100 +	\$64.00	<div style="background-color: black; color: white; padding: 10px; text-align: center;"> <h2>C In-Series</h2> <p>→</p> </div>											
PRICE																																													
1-24	\$31.06																																												
25-49	\$28.89																																												
50-99	\$26.71																																												
100 +	\$24.85																																												
PRICE																																													
1-24	\$64.80																																												
25-49	\$60.26																																												
50-99	\$55.73																																												
100 +	\$51.84																																												
PRICE																																													
1-24	\$80.00																																												
25-49	\$74.40																																												
50-99	\$68.80																																												
100 +	\$64.00																																												
5	 <table border="1"> <thead> <tr> <th colspan="2">PRICE</th> </tr> </thead> <tbody> <tr> <td>1-24</td> <td>\$47.12</td> </tr> <tr> <td>25-49</td> <td>\$43.82</td> </tr> <tr> <td>50-99</td> <td>\$40.52</td> </tr> <tr> <td>100 +</td> <td>\$37.70</td> </tr> </tbody> </table> <p>Model No: <b>PE9300</b> C Male To C Male</p>	PRICE		1-24	\$47.12	25-49	\$43.82	50-99	\$40.52	100 +	\$37.70	 <table border="1"> <thead> <tr> <th colspan="2">PRICE</th> </tr> </thead> <tbody> <tr> <td>1-24</td> <td>\$46.21</td> </tr> <tr> <td>25-49</td> <td>\$42.98</td> </tr> <tr> <td>50-99</td> <td>\$39.74</td> </tr> <tr> <td>100 +</td> <td>\$36.97</td> </tr> </tbody> </table> <p>Model No: <b>PE9293</b> C Male To C Female Right Angle</p>	PRICE		1-24	\$46.21	25-49	\$42.98	50-99	\$39.74	100 +	\$36.97	 <table border="1"> <thead> <tr> <th colspan="2">PRICE</th> </tr> </thead> <tbody> <tr> <td>1-24</td> <td>\$33.79</td> </tr> <tr> <td>25-49</td> <td>\$31.42</td> </tr> <tr> <td>50-99</td> <td>\$29.06</td> </tr> <tr> <td>100 +</td> <td>\$27.03</td> </tr> </tbody> </table> <p>Model No: <b>PE9208</b> C Female To C Female</p>	PRICE		1-24	\$33.79	25-49	\$31.42	50-99	\$29.06	100 +	\$27.03	 <table border="1"> <thead> <tr> <th colspan="2">PRICE</th> </tr> </thead> <tbody> <tr> <td>1-24</td> <td>\$70.68</td> </tr> <tr> <td>25-49</td> <td>\$65.73</td> </tr> <tr> <td>50-99</td> <td>\$60.78</td> </tr> <tr> <td>100 +</td> <td>\$56.54</td> </tr> </tbody> </table> <p>Model No: <b>PE9186</b> C Female To C Female Bulkhead Mounting Hole B07</p>		PRICE		1-24	\$70.68	25-49	\$65.73	50-99	\$60.78	100 +	\$56.54
PRICE																																													
1-24	\$47.12																																												
25-49	\$43.82																																												
50-99	\$40.52																																												
100 +	\$37.70																																												
PRICE																																													
1-24	\$46.21																																												
25-49	\$42.98																																												
50-99	\$39.74																																												
100 +	\$36.97																																												
PRICE																																													
1-24	\$33.79																																												
25-49	\$31.42																																												
50-99	\$29.06																																												
100 +	\$27.03																																												
PRICE																																													
1-24	\$70.68																																												
25-49	\$65.73																																												
50-99	\$60.78																																												
100 +	\$56.54																																												
6	 <table border="1"> <thead> <tr> <th colspan="2">PRICE</th> </tr> </thead> <tbody> <tr> <td>1-24</td> <td>\$52.03</td> </tr> <tr> <td>25-49</td> <td>\$48.39</td> </tr> <tr> <td>50-99</td> <td>\$44.75</td> </tr> <tr> <td>100 +</td> <td>\$41.62</td> </tr> </tbody> </table> <p>Model No: <b>PE9207</b> C "T" Female-Male-Female</p>	PRICE		1-24	\$52.03	25-49	\$48.39	50-99	\$44.75	100 +	\$41.62	 <table border="1"> <thead> <tr> <th colspan="2">PRICE</th> </tr> </thead> <tbody> <tr> <td>1-24</td> <td>\$70.68</td> </tr> <tr> <td>25-49</td> <td>\$65.73</td> </tr> <tr> <td>50-99</td> <td>\$60.78</td> </tr> <tr> <td>100 +</td> <td>\$56.54</td> </tr> </tbody> </table> <p>Model No: <b>PE9294</b> C "T" Female-Female-Female</p>	PRICE		1-24	\$70.68	25-49	\$65.73	50-99	\$60.78	100 +	\$56.54	<div style="background-color: black; color: white; padding: 10px; text-align: center;"> <h2>C Between-Series</h2> <p>→</p> </div>		 <table border="1"> <thead> <tr> <th colspan="2">PRICE</th> </tr> </thead> <tbody> <tr> <td>1-24</td> <td>\$142.62</td> </tr> <tr> <td>25-49</td> <td>\$132.64</td> </tr> <tr> <td>50-99</td> <td>\$122.65</td> </tr> <tr> <td>100 +</td> <td>\$114.10</td> </tr> </tbody> </table> <p>Model No: <b>PE9301</b> C Female To GR874</p>	PRICE		1-24	\$142.62	25-49	\$132.64	50-99	\$122.65	100 +	\$114.10										
PRICE																																													
1-24	\$52.03																																												
25-49	\$48.39																																												
50-99	\$44.75																																												
100 +	\$41.62																																												
PRICE																																													
1-24	\$70.68																																												
25-49	\$65.73																																												
50-99	\$60.78																																												
100 +	\$56.54																																												
PRICE																																													
1-24	\$142.62																																												
25-49	\$132.64																																												
50-99	\$122.65																																												
100 +	\$114.10																																												

# ADAPTERS

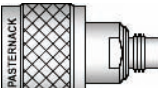
See Adapter Locator on Pages 140-145 or the Adapter Matrix on Pages 138-139

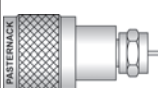
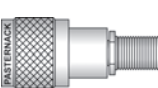
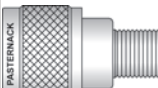
See Page 246 for Mounting Holes

	A	B	C	D																																								
1	<p><b>PAL In-Series</b></p> <p>→</p>	 <table border="1"> <thead> <tr> <th colspan="2">PRICE</th> </tr> </thead> <tbody> <tr> <td>1-24</td> <td>\$9.73</td> </tr> <tr> <td>25-49</td> <td>\$9.05</td> </tr> <tr> <td>50-99</td> <td>\$8.37</td> </tr> <tr> <td>100 +</td> <td>\$7.78</td> </tr> </tbody> </table> <p>Model No: <b>PE9680</b> PAL Plug To PAL Plug</p>	PRICE		1-24	\$9.73	25-49	\$9.05	50-99	\$8.37	100 +	\$7.78	 <table border="1"> <thead> <tr> <th colspan="2">PRICE</th> </tr> </thead> <tbody> <tr> <td>1-24</td> <td>\$9.73</td> </tr> <tr> <td>25-49</td> <td>\$9.05</td> </tr> <tr> <td>50-99</td> <td>\$8.37</td> </tr> <tr> <td>100 +</td> <td>\$7.78</td> </tr> </tbody> </table> <p>Model No: <b>PE9681</b> PAL Jack To PAL Jack</p>	PRICE		1-24	\$9.73	25-49	\$9.05	50-99	\$8.37	100 +	\$7.78	<p><b>75 Ohm N In-Series</b></p> <p>→</p>																				
PRICE																																												
1-24	\$9.73																																											
25-49	\$9.05																																											
50-99	\$8.37																																											
100 +	\$7.78																																											
PRICE																																												
1-24	\$9.73																																											
25-49	\$9.05																																											
50-99	\$8.37																																											
100 +	\$7.78																																											
2	 <table border="1"> <thead> <tr> <th colspan="2">PRICE</th> </tr> </thead> <tbody> <tr> <td>1-24</td> <td>\$22.95</td> </tr> <tr> <td>25-49</td> <td>\$21.34</td> </tr> <tr> <td>50-99</td> <td>\$19.74</td> </tr> <tr> <td>100 +</td> <td>\$18.36</td> </tr> </tbody> </table> <p>Model No: <b>PE9308</b> 75 Ohm N Male To 75 Ohm N Male</p>	PRICE		1-24	\$22.95	25-49	\$21.34	50-99	\$19.74	100 +	\$18.36	 <table border="1"> <thead> <tr> <th colspan="2">PRICE</th> </tr> </thead> <tbody> <tr> <td>1-24</td> <td>\$24.17</td> </tr> <tr> <td>25-49</td> <td>\$22.48</td> </tr> <tr> <td>50-99</td> <td>\$20.79</td> </tr> <tr> <td>100 +</td> <td>\$19.34</td> </tr> </tbody> </table> <p>Model No: <b>PE9391</b> 75 Ohm N Male To 75 Ohm N Female</p>	PRICE		1-24	\$24.17	25-49	\$22.48	50-99	\$20.79	100 +	\$19.34	 <table border="1"> <thead> <tr> <th colspan="2">PRICE</th> </tr> </thead> <tbody> <tr> <td>1-24</td> <td>\$31.36</td> </tr> <tr> <td>25-49</td> <td>\$29.16</td> </tr> <tr> <td>50-99</td> <td>\$26.97</td> </tr> <tr> <td>100 +</td> <td>\$25.09</td> </tr> </tbody> </table> <p>Model No: <b>PE9307</b> 75 Ohm N Male To 75 Ohm N Female Right Angle</p>	PRICE		1-24	\$31.36	25-49	\$29.16	50-99	\$26.97	100 +	\$25.09	 <table border="1"> <thead> <tr> <th colspan="2">PRICE</th> </tr> </thead> <tbody> <tr> <td>1-24</td> <td>\$22.95</td> </tr> <tr> <td>25-49</td> <td>\$21.34</td> </tr> <tr> <td>50-99</td> <td>\$19.74</td> </tr> <tr> <td>100 +</td> <td>\$18.36</td> </tr> </tbody> </table> <p>Model No: <b>PE9306</b> 75 Ohm N Female To 75 Ohm N Female</p>	PRICE		1-24	\$22.95	25-49	\$21.34	50-99	\$19.74	100 +	\$18.36
PRICE																																												
1-24	\$22.95																																											
25-49	\$21.34																																											
50-99	\$19.74																																											
100 +	\$18.36																																											
PRICE																																												
1-24	\$24.17																																											
25-49	\$22.48																																											
50-99	\$20.79																																											
100 +	\$19.34																																											
PRICE																																												
1-24	\$31.36																																											
25-49	\$29.16																																											
50-99	\$26.97																																											
100 +	\$25.09																																											
PRICE																																												
1-24	\$22.95																																											
25-49	\$21.34																																											
50-99	\$19.74																																											
100 +	\$18.36																																											
3	 <table border="1"> <thead> <tr> <th colspan="2">PRICE</th> </tr> </thead> <tbody> <tr> <td>1-24</td> <td>\$37.75</td> </tr> <tr> <td>25-49</td> <td>\$35.11</td> </tr> <tr> <td>50-99</td> <td>\$32.47</td> </tr> <tr> <td>100 +</td> <td>\$30.20</td> </tr> </tbody> </table> <p>Model No: <b>PE9416</b> 75 Ohm N Female To 75 Ohm N Female Bulkhead, Hermetically Sealed Mounting Hole G01</p>	PRICE		1-24	\$37.75	25-49	\$35.11	50-99	\$32.47	100 +	\$30.20	 <table border="1"> <thead> <tr> <th colspan="2">PRICE</th> </tr> </thead> <tbody> <tr> <td>1-24</td> <td>\$58.87</td> </tr> <tr> <td>25-49</td> <td>\$54.75</td> </tr> <tr> <td>50-99</td> <td>\$50.63</td> </tr> <tr> <td>100 +</td> <td>\$47.10</td> </tr> </tbody> </table> <p>Model No: <b>PE9417</b> 75 Ohm N Female To 75 Ohm N Female Bulkhead, Isolated Ground Mounting Hole G01</p>	PRICE		1-24	\$58.87	25-49	\$54.75	50-99	\$50.63	100 +	\$47.10	<p><b>75 Ohm N Between-Series</b></p> <p>→</p>	 <table border="1"> <thead> <tr> <th colspan="2">PRICE</th> </tr> </thead> <tbody> <tr> <td>1-24</td> <td>\$56.49</td> </tr> <tr> <td>25-49</td> <td>\$52.54</td> </tr> <tr> <td>50-99</td> <td>\$48.58</td> </tr> <tr> <td>100 +</td> <td>\$45.19</td> </tr> </tbody> </table> <p>Model No: <b>PE9626</b> 75 Ohm N Male To 75 Ohm TNC Male</p>	PRICE		1-24	\$56.49	25-49	\$52.54	50-99	\$48.58	100 +	\$45.19										
PRICE																																												
1-24	\$37.75																																											
25-49	\$35.11																																											
50-99	\$32.47																																											
100 +	\$30.20																																											
PRICE																																												
1-24	\$58.87																																											
25-49	\$54.75																																											
50-99	\$50.63																																											
100 +	\$47.10																																											
PRICE																																												
1-24	\$56.49																																											
25-49	\$52.54																																											
50-99	\$48.58																																											
100 +	\$45.19																																											
4	 <table border="1"> <thead> <tr> <th colspan="2">PRICE</th> </tr> </thead> <tbody> <tr> <td>1-24</td> <td>\$35.26</td> </tr> <tr> <td>25-49</td> <td>\$32.79</td> </tr> <tr> <td>50-99</td> <td>\$30.32</td> </tr> <tr> <td>100 +</td> <td>\$28.21</td> </tr> </tbody> </table> <p>Model No: <b>PE9627</b> 75 Ohm N Male To 75 Ohm TNC Female</p>	PRICE		1-24	\$35.26	25-49	\$32.79	50-99	\$30.32	100 +	\$28.21	 <table border="1"> <thead> <tr> <th colspan="2">PRICE</th> </tr> </thead> <tbody> <tr> <td>1-24</td> <td>\$35.26</td> </tr> <tr> <td>25-49</td> <td>\$32.79</td> </tr> <tr> <td>50-99</td> <td>\$30.32</td> </tr> <tr> <td>100 +</td> <td>\$28.21</td> </tr> </tbody> </table> <p>Model No: <b>PE9628</b> 75 Ohm N Female To 75 Ohm TNC Male</p>	PRICE		1-24	\$35.26	25-49	\$32.79	50-99	\$30.32	100 +	\$28.21	 <table border="1"> <thead> <tr> <th colspan="2">PRICE</th> </tr> </thead> <tbody> <tr> <td>1-24</td> <td>\$35.26</td> </tr> <tr> <td>25-49</td> <td>\$32.79</td> </tr> <tr> <td>50-99</td> <td>\$30.32</td> </tr> <tr> <td>100 +</td> <td>\$28.21</td> </tr> </tbody> </table> <p>Model No: <b>PE9629</b> 75 Ohm N Female To 75 Ohm TNC Female</p>	PRICE		1-24	\$35.26	25-49	\$32.79	50-99	\$30.32	100 +	\$28.21	 <table border="1"> <thead> <tr> <th colspan="2">PRICE</th> </tr> </thead> <tbody> <tr> <td>1-24</td> <td>\$70.68</td> </tr> <tr> <td>25-49</td> <td>\$65.73</td> </tr> <tr> <td>50-99</td> <td>\$60.78</td> </tr> <tr> <td>100 +</td> <td>\$56.54</td> </tr> </tbody> </table> <p>Model No: <b>PE9588</b> 75 Ohm N Male To 75 Ohm SMC Plug</p>	PRICE		1-24	\$70.68	25-49	\$65.73	50-99	\$60.78	100 +	\$56.54
PRICE																																												
1-24	\$35.26																																											
25-49	\$32.79																																											
50-99	\$30.32																																											
100 +	\$28.21																																											
PRICE																																												
1-24	\$35.26																																											
25-49	\$32.79																																											
50-99	\$30.32																																											
100 +	\$28.21																																											
PRICE																																												
1-24	\$35.26																																											
25-49	\$32.79																																											
50-99	\$30.32																																											
100 +	\$28.21																																											
PRICE																																												
1-24	\$70.68																																											
25-49	\$65.73																																											
50-99	\$60.78																																											
100 +	\$56.54																																											
5	 <table border="1"> <thead> <tr> <th colspan="2">PRICE</th> </tr> </thead> <tbody> <tr> <td>1-24</td> <td>\$65.16</td> </tr> <tr> <td>25-49</td> <td>\$60.60</td> </tr> <tr> <td>50-99</td> <td>\$56.04</td> </tr> <tr> <td>100 +</td> <td>\$52.13</td> </tr> </tbody> </table> <p>Model No: <b>PE9586</b> 75 Ohm N Male To 75 Ohm SMC Jack</p>	PRICE		1-24	\$65.16	25-49	\$60.60	50-99	\$56.04	100 +	\$52.13	 <table border="1"> <thead> <tr> <th colspan="2">PRICE</th> </tr> </thead> <tbody> <tr> <td>1-24</td> <td>\$70.68</td> </tr> <tr> <td>25-49</td> <td>\$65.73</td> </tr> <tr> <td>50-99</td> <td>\$60.78</td> </tr> <tr> <td>100 +</td> <td>\$56.54</td> </tr> </tbody> </table> <p>Model No: <b>PE9589</b> 75 Ohm N Female To 75 Ohm SMC Plug</p>	PRICE		1-24	\$70.68	25-49	\$65.73	50-99	\$60.78	100 +	\$56.54	 <table border="1"> <thead> <tr> <th colspan="2">PRICE</th> </tr> </thead> <tbody> <tr> <td>1-24</td> <td>\$65.16</td> </tr> <tr> <td>25-49</td> <td>\$60.60</td> </tr> <tr> <td>50-99</td> <td>\$56.04</td> </tr> <tr> <td>100 +</td> <td>\$52.13</td> </tr> </tbody> </table> <p>Model No: <b>PE9587</b> 75 Ohm N Female To 75 Ohm SMC Jack</p>	PRICE		1-24	\$65.16	25-49	\$60.60	50-99	\$56.04	100 +	\$52.13	 <table border="1"> <thead> <tr> <th colspan="2">PRICE</th> </tr> </thead> <tbody> <tr> <td>1-24</td> <td>\$70.93</td> </tr> <tr> <td>25-49</td> <td>\$65.96</td> </tr> <tr> <td>50-99</td> <td>\$61.00</td> </tr> <tr> <td>100 +</td> <td>\$56.74</td> </tr> </tbody> </table> <p><b>PRECISION</b> Model No: <b>PE9738</b> 75 Ohm N Male To F Male Max VSWR 1.30:1 @ 3 GHz</p>	PRICE		1-24	\$70.93	25-49	\$65.96	50-99	\$61.00	100 +	\$56.74
PRICE																																												
1-24	\$65.16																																											
25-49	\$60.60																																											
50-99	\$56.04																																											
100 +	\$52.13																																											
PRICE																																												
1-24	\$70.68																																											
25-49	\$65.73																																											
50-99	\$60.78																																											
100 +	\$56.54																																											
PRICE																																												
1-24	\$65.16																																											
25-49	\$60.60																																											
50-99	\$56.04																																											
100 +	\$52.13																																											
PRICE																																												
1-24	\$70.93																																											
25-49	\$65.96																																											
50-99	\$61.00																																											
100 +	\$56.74																																											
6	 <table border="1"> <thead> <tr> <th colspan="2">PRICE</th> </tr> </thead> <tbody> <tr> <td>1-24</td> <td>\$87.55</td> </tr> <tr> <td>25-49</td> <td>\$81.42</td> </tr> <tr> <td>50-99</td> <td>\$75.29</td> </tr> <tr> <td>100 +</td> <td>\$70.04</td> </tr> </tbody> </table> <p><b>PRECISION</b> Model No: <b>PE9737</b> 75 Ohm N Male To F Female Max VSWR 1.30:1 @ 3 GHz</p>	PRICE		1-24	\$87.55	25-49	\$81.42	50-99	\$75.29	100 +	\$70.04	 <table border="1"> <thead> <tr> <th colspan="2">PRICE</th> </tr> </thead> <tbody> <tr> <td>1-24</td> <td>\$30.37</td> </tr> <tr> <td>25-49</td> <td>\$28.24</td> </tr> <tr> <td>50-99</td> <td>\$26.12</td> </tr> <tr> <td>100 +</td> <td>\$24.30</td> </tr> </tbody> </table> <p>Model No: <b>PE9396</b> 75 Ohm N Male To F Female</p>	PRICE		1-24	\$30.37	25-49	\$28.24	50-99	\$26.12	100 +	\$24.30	 <table border="1"> <thead> <tr> <th colspan="2">PRICE</th> </tr> </thead> <tbody> <tr> <td>1-24</td> <td>\$69.41</td> </tr> <tr> <td>25-49</td> <td>\$64.55</td> </tr> <tr> <td>50-99</td> <td>\$59.69</td> </tr> <tr> <td>100 +</td> <td>\$55.53</td> </tr> </tbody> </table> <p><b>PRECISION</b> Model No: <b>PE9739</b> 75 Ohm N Female To F Male Max VSWR 1.30:1 @ 3 GHz</p>	PRICE		1-24	\$69.41	25-49	\$64.55	50-99	\$59.69	100 +	\$55.53	 <table border="1"> <thead> <tr> <th colspan="2">PRICE</th> </tr> </thead> <tbody> <tr> <td>1-24</td> <td>\$35.31</td> </tr> <tr> <td>25-49</td> <td>\$32.84</td> </tr> <tr> <td>50-99</td> <td>\$30.37</td> </tr> <tr> <td>100 +</td> <td>\$28.25</td> </tr> </tbody> </table> <p>Model No: <b>PE9397</b> 75 Ohm N Female To F Male</p>	PRICE		1-24	\$35.31	25-49	\$32.84	50-99	\$30.37	100 +	\$28.25
PRICE																																												
1-24	\$87.55																																											
25-49	\$81.42																																											
50-99	\$75.29																																											
100 +	\$70.04																																											
PRICE																																												
1-24	\$30.37																																											
25-49	\$28.24																																											
50-99	\$26.12																																											
100 +	\$24.30																																											
PRICE																																												
1-24	\$69.41																																											
25-49	\$64.55																																											
50-99	\$59.69																																											
100 +	\$55.53																																											
PRICE																																												
1-24	\$35.31																																											
25-49	\$32.84																																											
50-99	\$30.37																																											
100 +	\$28.25																																											

Adapters

See Our Website For Real-Time Stock Availability!



Free Freight Available  
via UPS Ground  
to USA & Canada



Real-Time Stock  
Levels & Pricing  
On Our Website



Toll-Free Technical  
Support  
(866) 727-8376



Same-Day Shipping,  
Even Custom  
Cable Assemblies











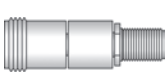







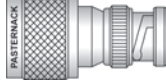

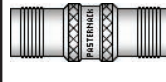

# ADAPTERS

See Adapter Locator on Pages 140-145 or the Adapter Matrix on Pages 138-139

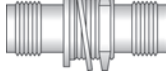
See Page 246 for Mounting Holes

Adapters

See Our Website For Real-Time Stock Availability!

	A	B	C	D																																								
1	 <table border="1"> <thead> <tr> <th colspan="2">PRICE</th> </tr> </thead> <tbody> <tr> <td>1-24</td> <td>\$91.15</td> </tr> <tr> <td>25-49</td> <td>\$84.77</td> </tr> <tr> <td>50-99</td> <td>\$78.39</td> </tr> <tr> <td>100 +</td> <td>\$72.92</td> </tr> </tbody> </table> <p><b>PRECISION</b> Model No: <b>PE9740</b> 75 Ohm N Female To F Female Max VSWR 1.30:1 @ 3 GHz</p>	PRICE		1-24	\$91.15	25-49	\$84.77	50-99	\$78.39	100 +	\$72.92	 <table border="1"> <thead> <tr> <th colspan="2">PRICE</th> </tr> </thead> <tbody> <tr> <td>1-24</td> <td>\$70.68</td> </tr> <tr> <td>25-49</td> <td>\$65.73</td> </tr> <tr> <td>50-99</td> <td>\$60.78</td> </tr> <tr> <td>100 +</td> <td>\$56.54</td> </tr> </tbody> </table> <p>Model No: <b>PE9584</b> 75 Ohm N Male To 75 Ohm SMB Plug</p>	PRICE		1-24	\$70.68	25-49	\$65.73	50-99	\$60.78	100 +	\$56.54	 <table border="1"> <thead> <tr> <th colspan="2">PRICE</th> </tr> </thead> <tbody> <tr> <td>1-24</td> <td>\$62.37</td> </tr> <tr> <td>25-49</td> <td>\$58.00</td> </tr> <tr> <td>50-99</td> <td>\$53.64</td> </tr> <tr> <td>100 +</td> <td>\$49.90</td> </tr> </tbody> </table> <p>Model No: <b>PE9582</b> 75 Ohm N Male To 75 Ohm SMB Jack</p>	PRICE		1-24	\$62.37	25-49	\$58.00	50-99	\$53.64	100 +	\$49.90	 <table border="1"> <thead> <tr> <th colspan="2">PRICE</th> </tr> </thead> <tbody> <tr> <td>1-24</td> <td>\$70.68</td> </tr> <tr> <td>25-49</td> <td>\$65.73</td> </tr> <tr> <td>50-99</td> <td>\$60.78</td> </tr> <tr> <td>100 +</td> <td>\$56.54</td> </tr> </tbody> </table> <p>Model No: <b>PE9585</b> 75 Ohm N Female To 75 Ohm SMB Plug</p>	PRICE		1-24	\$70.68	25-49	\$65.73	50-99	\$60.78	100 +	\$56.54
PRICE																																												
1-24	\$91.15																																											
25-49	\$84.77																																											
50-99	\$78.39																																											
100 +	\$72.92																																											
PRICE																																												
1-24	\$70.68																																											
25-49	\$65.73																																											
50-99	\$60.78																																											
100 +	\$56.54																																											
PRICE																																												
1-24	\$62.37																																											
25-49	\$58.00																																											
50-99	\$53.64																																											
100 +	\$49.90																																											
PRICE																																												
1-24	\$70.68																																											
25-49	\$65.73																																											
50-99	\$60.78																																											
100 +	\$56.54																																											
2	 <table border="1"> <thead> <tr> <th colspan="2">PRICE</th> </tr> </thead> <tbody> <tr> <td>1-24</td> <td>\$70.68</td> </tr> <tr> <td>25-49</td> <td>\$65.73</td> </tr> <tr> <td>50-99</td> <td>\$60.78</td> </tr> <tr> <td>100 +</td> <td>\$56.54</td> </tr> </tbody> </table> <p>Model No: <b>PE9583</b> 75 Ohm N Female To 75 Ohm SMB Jack</p>	PRICE		1-24	\$70.68	25-49	\$65.73	50-99	\$60.78	100 +	\$56.54	 <table border="1"> <thead> <tr> <th colspan="2">PRICE</th> </tr> </thead> <tbody> <tr> <td>1-24</td> <td>\$58.87</td> </tr> <tr> <td>25-49</td> <td>\$54.75</td> </tr> <tr> <td>50-99</td> <td>\$50.63</td> </tr> <tr> <td>100 +</td> <td>\$47.10</td> </tr> </tbody> </table> <p>Model No: <b>PE9612</b> 75 Ohm N Male To Mini 75 Ohm SMB Plug</p>	PRICE		1-24	\$58.87	25-49	\$54.75	50-99	\$50.63	100 +	\$47.10	 <table border="1"> <thead> <tr> <th colspan="2">PRICE</th> </tr> </thead> <tbody> <tr> <td>1-24</td> <td>\$57.81</td> </tr> <tr> <td>25-49</td> <td>\$53.76</td> </tr> <tr> <td>50-99</td> <td>\$49.72</td> </tr> <tr> <td>100 +</td> <td>\$46.25</td> </tr> </tbody> </table> <p>Model No: <b>PE9614</b> 75 Ohm N Male To Mini 75 Ohm SMB Jack</p>	PRICE		1-24	\$57.81	25-49	\$53.76	50-99	\$49.72	100 +	\$46.25	 <table border="1"> <thead> <tr> <th colspan="2">PRICE</th> </tr> </thead> <tbody> <tr> <td>1-24</td> <td>\$82.33</td> </tr> <tr> <td>25-49</td> <td>\$76.57</td> </tr> <tr> <td>50-99</td> <td>\$70.80</td> </tr> <tr> <td>100 +</td> <td>\$65.86</td> </tr> </tbody> </table> <p>Model No: <b>PE9613</b> 75 Ohm N Female To Mini 75 Ohm SMB Plug</p>	PRICE		1-24	\$82.33	25-49	\$76.57	50-99	\$70.80	100 +	\$65.86
PRICE																																												
1-24	\$70.68																																											
25-49	\$65.73																																											
50-99	\$60.78																																											
100 +	\$56.54																																											
PRICE																																												
1-24	\$58.87																																											
25-49	\$54.75																																											
50-99	\$50.63																																											
100 +	\$47.10																																											
PRICE																																												
1-24	\$57.81																																											
25-49	\$53.76																																											
50-99	\$49.72																																											
100 +	\$46.25																																											
PRICE																																												
1-24	\$82.33																																											
25-49	\$76.57																																											
50-99	\$70.80																																											
100 +	\$65.86																																											
3	 <table border="1"> <thead> <tr> <th colspan="2">PRICE</th> </tr> </thead> <tbody> <tr> <td>1-24</td> <td>\$58.87</td> </tr> <tr> <td>25-49</td> <td>\$54.75</td> </tr> <tr> <td>50-99</td> <td>\$50.63</td> </tr> <tr> <td>100 +</td> <td>\$47.10</td> </tr> </tbody> </table> <p>Model No: <b>PE9615</b> 75 Ohm N Female To Mini 75 Ohm SMB Jack</p>	PRICE		1-24	\$58.87	25-49	\$54.75	50-99	\$50.63	100 +	\$47.10	 <table border="1"> <thead> <tr> <th colspan="2">PRICE</th> </tr> </thead> <tbody> <tr> <td>1-24</td> <td>\$46.71</td> </tr> <tr> <td>25-49</td> <td>\$43.44</td> </tr> <tr> <td>50-99</td> <td>\$40.17</td> </tr> <tr> <td>100 +</td> <td>\$37.37</td> </tr> </tbody> </table> <p>Model No: <b>PE9370</b> 75 Ohm N Male To 75 Ohm BNC Male Mates With 50 Ohm BNC</p>	PRICE		1-24	\$46.71	25-49	\$43.44	50-99	\$40.17	100 +	\$37.37	 <table border="1"> <thead> <tr> <th colspan="2">PRICE</th> </tr> </thead> <tbody> <tr> <td>1-24</td> <td>\$23.46</td> </tr> <tr> <td>25-49</td> <td>\$21.82</td> </tr> <tr> <td>50-99</td> <td>\$20.18</td> </tr> <tr> <td>100 +</td> <td>\$18.77</td> </tr> </tbody> </table> <p>Model No: <b>PE9369</b> 75 Ohm N Male To 75 Ohm BNC Female Mates With 50 Ohm BNC</p>	PRICE		1-24	\$23.46	25-49	\$21.82	50-99	\$20.18	100 +	\$18.77	 <table border="1"> <thead> <tr> <th colspan="2">PRICE</th> </tr> </thead> <tbody> <tr> <td>1-24</td> <td>\$22.95</td> </tr> <tr> <td>25-49</td> <td>\$21.34</td> </tr> <tr> <td>50-99</td> <td>\$19.74</td> </tr> <tr> <td>100 +</td> <td>\$18.36</td> </tr> </tbody> </table> <p>Model No: <b>PE9368</b> 75 Ohm N Female To 75 Ohm BNC Male Mates With 50 Ohm BNC</p>	PRICE		1-24	\$22.95	25-49	\$21.34	50-99	\$19.74	100 +	\$18.36
PRICE																																												
1-24	\$58.87																																											
25-49	\$54.75																																											
50-99	\$50.63																																											
100 +	\$47.10																																											
PRICE																																												
1-24	\$46.71																																											
25-49	\$43.44																																											
50-99	\$40.17																																											
100 +	\$37.37																																											
PRICE																																												
1-24	\$23.46																																											
25-49	\$21.82																																											
50-99	\$20.18																																											
100 +	\$18.77																																											
PRICE																																												
1-24	\$22.95																																											
25-49	\$21.34																																											
50-99	\$19.74																																											
100 +	\$18.36																																											
4	 <table border="1"> <thead> <tr> <th colspan="2">PRICE</th> </tr> </thead> <tbody> <tr> <td>1-24</td> <td>\$66.98</td> </tr> <tr> <td>25-49</td> <td>\$62.29</td> </tr> <tr> <td>50-99</td> <td>\$57.60</td> </tr> <tr> <td>100 +</td> <td>\$53.58</td> </tr> </tbody> </table> <p>Model No: <b>PE9371</b> 75 Ohm N Female To 75 Ohm BNC Female Mates With 50 Ohm BNC</p>	PRICE		1-24	\$66.98	25-49	\$62.29	50-99	\$57.60	100 +	\$53.58	<p><b>75 Ohm TNC In-Series</b></p> 		 <table border="1"> <thead> <tr> <th colspan="2">PRICE</th> </tr> </thead> <tbody> <tr> <td>1-24</td> <td>\$52.94</td> </tr> <tr> <td>25-49</td> <td>\$49.23</td> </tr> <tr> <td>50-99</td> <td>\$45.53</td> </tr> <tr> <td>100 +</td> <td>\$42.35</td> </tr> </tbody> </table> <p>Model No: <b>PE9623</b> 75 Ohm TNC Male To 75 Ohm TNC Female Right Angle</p>	PRICE		1-24	\$52.94	25-49	\$49.23	50-99	\$45.53	100 +	\$42.35	 <table border="1"> <thead> <tr> <th colspan="2">PRICE</th> </tr> </thead> <tbody> <tr> <td>1-24</td> <td>\$23.51</td> </tr> <tr> <td>25-49</td> <td>\$21.86</td> </tr> <tr> <td>50-99</td> <td>\$20.22</td> </tr> <tr> <td>100 +</td> <td>\$18.81</td> </tr> </tbody> </table> <p>Model No: <b>PE9622</b> 75 Ohm TNC Female To 75 Ohm TNC Female</p>	PRICE		1-24	\$23.51	25-49	\$21.86	50-99	\$20.22	100 +	\$18.81									
PRICE																																												
1-24	\$66.98																																											
25-49	\$62.29																																											
50-99	\$57.60																																											
100 +	\$53.58																																											
PRICE																																												
1-24	\$52.94																																											
25-49	\$49.23																																											
50-99	\$45.53																																											
100 +	\$42.35																																											
PRICE																																												
1-24	\$23.51																																											
25-49	\$21.86																																											
50-99	\$20.22																																											
100 +	\$18.81																																											
5	 <table border="1"> <thead> <tr> <th colspan="2">PRICE</th> </tr> </thead> <tbody> <tr> <td>1-24</td> <td>\$57.81</td> </tr> <tr> <td>25-49</td> <td>\$53.76</td> </tr> <tr> <td>50-99</td> <td>\$49.72</td> </tr> <tr> <td>100 +</td> <td>\$46.25</td> </tr> </tbody> </table> <p>Model No: <b>PE9624</b> 75 Ohm TNC Female To 75 Ohm TNC Female Bulkhead, Hermetically Sealed Mounting Hole B06</p>	PRICE		1-24	\$57.81	25-49	\$53.76	50-99	\$49.72	100 +	\$46.25	 <table border="1"> <thead> <tr> <th colspan="2">PRICE</th> </tr> </thead> <tbody> <tr> <td>1-24</td> <td>\$35.26</td> </tr> <tr> <td>25-49</td> <td>\$32.79</td> </tr> <tr> <td>50-99</td> <td>\$30.32</td> </tr> <tr> <td>100 +</td> <td>\$28.21</td> </tr> </tbody> </table> <p>Model No: <b>PE9625</b> 75 Ohm TNC Female To 75 Ohm TNC Female Bulkhead, Isolated Ground Mounting Hole B06</p>	PRICE		1-24	\$35.26	25-49	\$32.79	50-99	\$30.32	100 +	\$28.21	<p><b>75 Ohm TNC Between-Series</b></p> 		 <table border="1"> <thead> <tr> <th colspan="2">PRICE</th> </tr> </thead> <tbody> <tr> <td>1-24</td> <td>\$16.87</td> </tr> <tr> <td>25-49</td> <td>\$15.69</td> </tr> <tr> <td>50-99</td> <td>\$14.51</td> </tr> <tr> <td>100 +</td> <td>\$13.50</td> </tr> </tbody> </table> <p>Model No: <b>PE9631</b> 75 Ohm TNC Male To 75 Ohm BNC Female</p>	PRICE		1-24	\$16.87	25-49	\$15.69	50-99	\$14.51	100 +	\$13.50									
PRICE																																												
1-24	\$57.81																																											
25-49	\$53.76																																											
50-99	\$49.72																																											
100 +	\$46.25																																											
PRICE																																												
1-24	\$35.26																																											
25-49	\$32.79																																											
50-99	\$30.32																																											
100 +	\$28.21																																											
PRICE																																												
1-24	\$16.87																																											
25-49	\$15.69																																											
50-99	\$14.51																																											
100 +	\$13.50																																											
6	 <table border="1"> <thead> <tr> <th colspan="2">PRICE</th> </tr> </thead> <tbody> <tr> <td>1-24</td> <td>\$35.26</td> </tr> <tr> <td>25-49</td> <td>\$32.79</td> </tr> <tr> <td>50-99</td> <td>\$30.32</td> </tr> <tr> <td>100 +</td> <td>\$28.21</td> </tr> </tbody> </table> <p>Model No: <b>PE9630</b> 75 Ohm TNC Female To 75 Ohm BNC Male</p>	PRICE		1-24	\$35.26	25-49	\$32.79	50-99	\$30.32	100 +	\$28.21	<p><b>75 Ohm SMC In-Series</b></p> 		 <table border="1"> <thead> <tr> <th colspan="2">PRICE</th> </tr> </thead> <tbody> <tr> <td>1-24</td> <td>\$31.92</td> </tr> <tr> <td>25-49</td> <td>\$29.69</td> </tr> <tr> <td>50-99</td> <td>\$27.45</td> </tr> <tr> <td>100 +</td> <td>\$25.54</td> </tr> </tbody> </table> <p>Model No: <b>PE9272</b> 75 Ohm SMC Plug To 75 Ohm SMC Plug</p>	PRICE		1-24	\$31.92	25-49	\$29.69	50-99	\$27.45	100 +	\$25.54	 <table border="1"> <thead> <tr> <th colspan="2">PRICE</th> </tr> </thead> <tbody> <tr> <td>1-24</td> <td>\$28.22</td> </tr> <tr> <td>25-49</td> <td>\$26.24</td> </tr> <tr> <td>50-99</td> <td>\$24.27</td> </tr> <tr> <td>100 +</td> <td>\$22.58</td> </tr> </tbody> </table> <p>Model No: <b>PE9277</b> 75 Ohm SMC Jack To 75 Ohm SMC Jack</p>	PRICE		1-24	\$28.22	25-49	\$26.24	50-99	\$24.27	100 +	\$22.58									
PRICE																																												
1-24	\$35.26																																											
25-49	\$32.79																																											
50-99	\$30.32																																											
100 +	\$28.21																																											
PRICE																																												
1-24	\$31.92																																											
25-49	\$29.69																																											
50-99	\$27.45																																											
100 +	\$25.54																																											
PRICE																																												
1-24	\$28.22																																											
25-49	\$26.24																																											
50-99	\$24.27																																											
100 +	\$22.58																																											











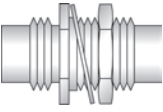

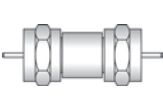

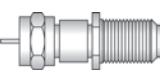
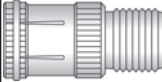

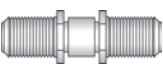
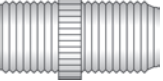
ROHS & REACH COMPLIANT. CUSTOM-LENGTH CABLE ASSEMBLIES MAY BE ORDERED ON OUR WEBSITE.

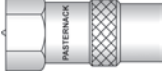

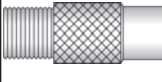
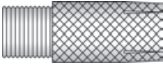
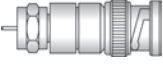
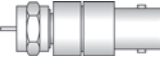
# ADAPTERS

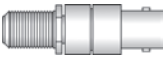
See Adapter Locator on Pages 140-145 or the Adapter Matrix on Pages 138-139

See Page 246 for Mounting Holes

	A	B	C	D																																								
1	 <table border="1"> <thead> <tr> <th colspan="2">PRICE</th> </tr> </thead> <tbody> <tr> <td>1-24</td> <td>\$35.26</td> </tr> <tr> <td>25-49</td> <td>\$32.79</td> </tr> <tr> <td>50-99</td> <td>\$30.32</td> </tr> <tr> <td>100 +</td> <td>\$28.21</td> </tr> </tbody> </table> <p><b>Model No: PE9228</b> 75 Ohm SMC Jack To 75 Ohm SMC Jack Bulkhead Mounting Hole B03</p>	PRICE		1-24	\$35.26	25-49	\$32.79	50-99	\$30.32	100 +	\$28.21	 <table border="1"> <thead> <tr> <th colspan="2">PRICE</th> </tr> </thead> <tbody> <tr> <td>1-24</td> <td>\$52.94</td> </tr> <tr> <td>25-49</td> <td>\$49.23</td> </tr> <tr> <td>50-99</td> <td>\$45.53</td> </tr> <tr> <td>100 +</td> <td>\$42.35</td> </tr> </tbody> </table> <p><b>Model No: PE9244</b> 75 Ohm SMC "T" Jack-Plug-Jack</p>	PRICE		1-24	\$52.94	25-49	\$49.23	50-99	\$45.53	100 +	\$42.35	<p><b>75 Ohm F In-Series</b></p> 		 <table border="1"> <thead> <tr> <th colspan="2">PRICE</th> </tr> </thead> <tbody> <tr> <td>1-24</td> <td>\$52.94</td> </tr> <tr> <td>25-49</td> <td>\$49.23</td> </tr> <tr> <td>50-99</td> <td>\$45.53</td> </tr> <tr> <td>100 +</td> <td>\$42.35</td> </tr> </tbody> </table> <p><b>PRECISION</b> <b>Model No: PE9760</b> F Male To F Male Max VSWR 1.30:1 @ 3 GHz</p>	PRICE		1-24	\$52.94	25-49	\$49.23	50-99	\$45.53	100 +	\$42.35									
	PRICE																																											
1-24	\$35.26																																											
25-49	\$32.79																																											
50-99	\$30.32																																											
100 +	\$28.21																																											
PRICE																																												
1-24	\$52.94																																											
25-49	\$49.23																																											
50-99	\$45.53																																											
100 +	\$42.35																																											
PRICE																																												
1-24	\$52.94																																											
25-49	\$49.23																																											
50-99	\$45.53																																											
100 +	\$42.35																																											
2	 <table border="1"> <thead> <tr> <th colspan="2">PRICE</th> </tr> </thead> <tbody> <tr> <td>1-24</td> <td>\$10.84</td> </tr> <tr> <td>25-49</td> <td>\$10.08</td> </tr> <tr> <td>50-99</td> <td>\$9.32</td> </tr> <tr> <td>100 +</td> <td>\$8.67</td> </tr> </tbody> </table> <p><b>Model No: PE9159</b> F Male To F Male</p>	PRICE		1-24	\$10.84	25-49	\$10.08	50-99	\$9.32	100 +	\$8.67	 <table border="1"> <thead> <tr> <th colspan="2">PRICE</th> </tr> </thead> <tbody> <tr> <td>1-24</td> <td>\$52.94</td> </tr> <tr> <td>25-49</td> <td>\$49.23</td> </tr> <tr> <td>50-99</td> <td>\$45.53</td> </tr> <tr> <td>100 +</td> <td>\$42.35</td> </tr> </tbody> </table> <p><b>PRECISION</b> <b>Model No: PE9759</b> F Male To F Female Max VSWR 1.30:1 @ 3 GHz</p>	PRICE		1-24	\$52.94	25-49	\$49.23	50-99	\$45.53	100 +	\$42.35	 <table border="1"> <thead> <tr> <th colspan="2">PRICE</th> </tr> </thead> <tbody> <tr> <td>1-24</td> <td>\$10.84</td> </tr> <tr> <td>25-49</td> <td>\$10.08</td> </tr> <tr> <td>50-99</td> <td>\$9.32</td> </tr> <tr> <td>100 +</td> <td>\$8.67</td> </tr> </tbody> </table> <p><b>Model No: PE9160</b> F Male Push On To F Female</p>	PRICE		1-24	\$10.84	25-49	\$10.08	50-99	\$9.32	100 +	\$8.67	 <table border="1"> <thead> <tr> <th colspan="2">PRICE</th> </tr> </thead> <tbody> <tr> <td>1-24</td> <td>\$9.58</td> </tr> <tr> <td>25-49</td> <td>\$8.91</td> </tr> <tr> <td>50-99</td> <td>\$8.24</td> </tr> <tr> <td>100 +</td> <td>\$7.66</td> </tr> </tbody> </table> <p><b>Model No: PE9166</b> F Male To F Female Right Angle</p>	PRICE		1-24	\$9.58	25-49	\$8.91	50-99	\$8.24	100 +	\$7.66
	PRICE																																											
1-24	\$10.84																																											
25-49	\$10.08																																											
50-99	\$9.32																																											
100 +	\$8.67																																											
PRICE																																												
1-24	\$52.94																																											
25-49	\$49.23																																											
50-99	\$45.53																																											
100 +	\$42.35																																											
PRICE																																												
1-24	\$10.84																																											
25-49	\$10.08																																											
50-99	\$9.32																																											
100 +	\$8.67																																											
PRICE																																												
1-24	\$9.58																																											
25-49	\$8.91																																											
50-99	\$8.24																																											
100 +	\$7.66																																											
3	 <table border="1"> <thead> <tr> <th colspan="2">PRICE</th> </tr> </thead> <tbody> <tr> <td>1-24</td> <td>\$52.03</td> </tr> <tr> <td>25-49</td> <td>\$48.39</td> </tr> <tr> <td>50-99</td> <td>\$44.75</td> </tr> <tr> <td>100 +</td> <td>\$41.62</td> </tr> </tbody> </table> <p><b>PRECISION</b> <b>Model No: PE9761</b> F Female To F Female Max VSWR 1.30:1 @ 3 GHz</p>	PRICE		1-24	\$52.03	25-49	\$48.39	50-99	\$44.75	100 +	\$41.62	 <table border="1"> <thead> <tr> <th colspan="2">PRICE</th> </tr> </thead> <tbody> <tr> <td>1-24</td> <td>\$5.04</td> </tr> <tr> <td>25-49</td> <td>\$4.69</td> </tr> <tr> <td>50-99</td> <td>\$4.33</td> </tr> <tr> <td>100 +</td> <td>\$4.03</td> </tr> </tbody> </table> <p><b>Model No: PE9164</b> F Female To F Female</p>	PRICE		1-24	\$5.04	25-49	\$4.69	50-99	\$4.33	100 +	\$4.03	 <table border="1"> <thead> <tr> <th colspan="2">PRICE</th> </tr> </thead> <tbody> <tr> <td>1-24</td> <td>\$11.86</td> </tr> <tr> <td>25-49</td> <td>\$11.03</td> </tr> <tr> <td>50-99</td> <td>\$10.20</td> </tr> <tr> <td>100 +</td> <td>\$9.49</td> </tr> </tbody> </table> <p><b>Model No: PE9734</b> F Female To F Female Bulkhead Mounting Hole B04</p>	PRICE		1-24	\$11.86	25-49	\$11.03	50-99	\$10.20	100 +	\$9.49	<p><b>75 Ohm F Between-Series</b></p> 										
	PRICE																																											
1-24	\$52.03																																											
25-49	\$48.39																																											
50-99	\$44.75																																											
100 +	\$41.62																																											
PRICE																																												
1-24	\$5.04																																											
25-49	\$4.69																																											
50-99	\$4.33																																											
100 +	\$4.03																																											
PRICE																																												
1-24	\$11.86																																											
25-49	\$11.03																																											
50-99	\$10.20																																											
100 +	\$9.49																																											
4	 <table border="1"> <thead> <tr> <th colspan="2">PRICE</th> </tr> </thead> <tbody> <tr> <td>1-24</td> <td>\$10.59</td> </tr> <tr> <td>25-49</td> <td>\$9.85</td> </tr> <tr> <td>50-99</td> <td>\$9.11</td> </tr> <tr> <td>100 +</td> <td>\$8.47</td> </tr> </tbody> </table> <p><b>Model No: PE9633</b> F Male To PAL Plug</p>	PRICE		1-24	\$10.59	25-49	\$9.85	50-99	\$9.11	100 +	\$8.47	 <table border="1"> <thead> <tr> <th colspan="2">PRICE</th> </tr> </thead> <tbody> <tr> <td>1-24</td> <td>\$10.59</td> </tr> <tr> <td>25-49</td> <td>\$9.85</td> </tr> <tr> <td>50-99</td> <td>\$9.11</td> </tr> <tr> <td>100 +</td> <td>\$8.47</td> </tr> </tbody> </table> <p><b>Model No: PE9632</b> F Male To PAL Jack</p>	PRICE		1-24	\$10.59	25-49	\$9.85	50-99	\$9.11	100 +	\$8.47	 <table border="1"> <thead> <tr> <th colspan="2">PRICE</th> </tr> </thead> <tbody> <tr> <td>1-24</td> <td>\$9.58</td> </tr> <tr> <td>25-49</td> <td>\$8.91</td> </tr> <tr> <td>50-99</td> <td>\$8.24</td> </tr> <tr> <td>100 +</td> <td>\$7.66</td> </tr> </tbody> </table> <p><b>Model No: PE9635</b> F Female To PAL Plug</p>	PRICE		1-24	\$9.58	25-49	\$8.91	50-99	\$8.24	100 +	\$7.66	 <table border="1"> <thead> <tr> <th colspan="2">PRICE</th> </tr> </thead> <tbody> <tr> <td>1-24</td> <td>\$10.59</td> </tr> <tr> <td>25-49</td> <td>\$9.85</td> </tr> <tr> <td>50-99</td> <td>\$9.11</td> </tr> <tr> <td>100 +</td> <td>\$8.47</td> </tr> </tbody> </table> <p><b>Model No: PE9634</b> F Female To PAL Jack</p>	PRICE		1-24	\$10.59	25-49	\$9.85	50-99	\$9.11	100 +	\$8.47
	PRICE																																											
1-24	\$10.59																																											
25-49	\$9.85																																											
50-99	\$9.11																																											
100 +	\$8.47																																											
PRICE																																												
1-24	\$10.59																																											
25-49	\$9.85																																											
50-99	\$9.11																																											
100 +	\$8.47																																											
PRICE																																												
1-24	\$9.58																																											
25-49	\$8.91																																											
50-99	\$8.24																																											
100 +	\$7.66																																											
PRICE																																												
1-24	\$10.59																																											
25-49	\$9.85																																											
50-99	\$9.11																																											
100 +	\$8.47																																											
5	 <table border="1"> <thead> <tr> <th colspan="2">PRICE</th> </tr> </thead> <tbody> <tr> <td>1-24</td> <td>\$70.68</td> </tr> <tr> <td>25-49</td> <td>\$65.73</td> </tr> <tr> <td>50-99</td> <td>\$60.78</td> </tr> <tr> <td>100 +</td> <td>\$56.54</td> </tr> </tbody> </table> <p><b>PRECISION</b> <b>Model No: PE9742</b> F Male To 75 Ohm BNC Male Max VSWR 1.30:1 @ 3 GHz</p>	PRICE		1-24	\$70.68	25-49	\$65.73	50-99	\$60.78	100 +	\$56.54	 <table border="1"> <thead> <tr> <th colspan="2">PRICE</th> </tr> </thead> <tbody> <tr> <td>1-24</td> <td>\$80.96</td> </tr> <tr> <td>25-49</td> <td>\$75.29</td> </tr> <tr> <td>50-99</td> <td>\$69.63</td> </tr> <tr> <td>100 +</td> <td>\$64.77</td> </tr> </tbody> </table> <p><b>PRECISION</b> <b>Model No: PE9743</b> F Male To 75 Ohm BNC Female Max VSWR 1.30:1 @ 3 GHz</p>	PRICE		1-24	\$80.96	25-49	\$75.29	50-99	\$69.63	100 +	\$64.77	 <table border="1"> <thead> <tr> <th colspan="2">PRICE</th> </tr> </thead> <tbody> <tr> <td>1-24</td> <td>\$80.96</td> </tr> <tr> <td>25-49</td> <td>\$75.29</td> </tr> <tr> <td>50-99</td> <td>\$69.63</td> </tr> <tr> <td>100 +</td> <td>\$64.77</td> </tr> </tbody> </table> <p><b>PRECISION</b> <b>Model No: PE9741</b> F Female To 75 Ohm BNC Male Max VSWR 1.30:1 @ 3 GHz</p>	PRICE		1-24	\$80.96	25-49	\$75.29	50-99	\$69.63	100 +	\$64.77	 <table border="1"> <thead> <tr> <th colspan="2">PRICE</th> </tr> </thead> <tbody> <tr> <td>1-24</td> <td>\$83.24</td> </tr> <tr> <td>25-49</td> <td>\$77.41</td> </tr> <tr> <td>50-99</td> <td>\$71.59</td> </tr> <tr> <td>100 +</td> <td>\$66.59</td> </tr> </tbody> </table> <p><b>PRECISION</b> <b>Model No: PE9744</b> F Female To 75 Ohm BNC Female Max VSWR 1.30:1 @ 3 GHz</p>	PRICE		1-24	\$83.24	25-49	\$77.41	50-99	\$71.59	100 +	\$66.59
	PRICE																																											
1-24	\$70.68																																											
25-49	\$65.73																																											
50-99	\$60.78																																											
100 +	\$56.54																																											
PRICE																																												
1-24	\$80.96																																											
25-49	\$75.29																																											
50-99	\$69.63																																											
100 +	\$64.77																																											
PRICE																																												
1-24	\$80.96																																											
25-49	\$75.29																																											
50-99	\$69.63																																											
100 +	\$64.77																																											
PRICE																																												
1-24	\$83.24																																											
25-49	\$77.41																																											
50-99	\$71.59																																											
100 +	\$66.59																																											
6	 <table border="1"> <thead> <tr> <th colspan="2">PRICE</th> </tr> </thead> <tbody> <tr> <td>1-24</td> <td>\$11.80</td> </tr> <tr> <td>25-49</td> <td>\$10.97</td> </tr> <tr> <td>50-99</td> <td>\$10.15</td> </tr> <tr> <td>100 +</td> <td>\$9.44</td> </tr> </tbody> </table> <p><b>Model No: PE9163</b> F Female To RCA Plug</p>	PRICE		1-24	\$11.80	25-49	\$10.97	50-99	\$10.15	100 +	\$9.44	 <table border="1"> <thead> <tr> <th colspan="2">PRICE</th> </tr> </thead> <tbody> <tr> <td>1-24</td> <td>\$10.99</td> </tr> <tr> <td>25-49</td> <td>\$10.22</td> </tr> <tr> <td>50-99</td> <td>\$9.45</td> </tr> <tr> <td>100 +</td> <td>\$8.79</td> </tr> </tbody> </table> <p><b>Model No: PE9168</b> F Female To RCA Jack</p>	PRICE		1-24	\$10.99	25-49	\$10.22	50-99	\$9.45	100 +	\$8.79	<p><b>75 Ohm SMB In-Series</b></p> 		 <table border="1"> <thead> <tr> <th colspan="2">PRICE</th> </tr> </thead> <tbody> <tr> <td>1-24</td> <td>\$44.23</td> </tr> <tr> <td>25-49</td> <td>\$41.13</td> </tr> <tr> <td>50-99</td> <td>\$38.04</td> </tr> <tr> <td>100 +</td> <td>\$35.38</td> </tr> </tbody> </table> <p><b>Model No: PE9271</b> 75 Ohm SMB Plug To 75 Ohm SMB Plug</p>	PRICE		1-24	\$44.23	25-49	\$41.13	50-99	\$38.04	100 +	\$35.38									
	PRICE																																											
1-24	\$11.80																																											
25-49	\$10.97																																											
50-99	\$10.15																																											
100 +	\$9.44																																											
PRICE																																												
1-24	\$10.99																																											
25-49	\$10.22																																											
50-99	\$9.45																																											
100 +	\$8.79																																											
PRICE																																												
1-24	\$44.23																																											
25-49	\$41.13																																											
50-99	\$38.04																																											
100 +	\$35.38																																											

Adapters

See Our Website For Real-Time Stock Availability!













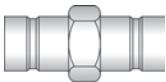

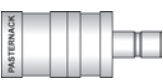
# ADAPTERS

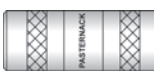
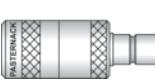
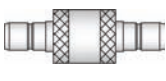
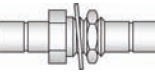
See Adapter Locator on Pages 140-145 or the Adapter Matrix on Pages 138-139

See Page 246 for Mounting Holes

Adapters

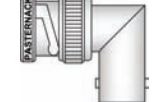
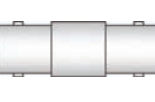
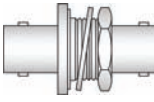
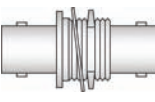
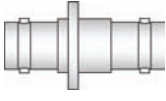

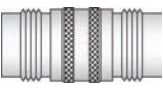







See Our Website For Real-Time Stock Availability!

	A	B	C	D																																								
1	 <table border="1"> <thead> <tr> <th colspan="2">PRICE</th> </tr> </thead> <tbody> <tr> <td>1-24</td> <td>\$44.23</td> </tr> <tr> <td>25-49</td> <td>\$41.13</td> </tr> <tr> <td>50-99</td> <td>\$38.04</td> </tr> <tr> <td>100 +</td> <td>\$35.38</td> </tr> </tbody> </table> <p><b>Model No: PE9248</b> 75 Ohm SMB Jack To 75 Ohm SMB Jack</p>	PRICE		1-24	\$44.23	25-49	\$41.13	50-99	\$38.04	100 +	\$35.38	 <table border="1"> <thead> <tr> <th colspan="2">PRICE</th> </tr> </thead> <tbody> <tr> <td>1-24</td> <td>\$42.96</td> </tr> <tr> <td>25-49</td> <td>\$39.95</td> </tr> <tr> <td>50-99</td> <td>\$36.95</td> </tr> <tr> <td>100 +</td> <td>\$34.37</td> </tr> </tbody> </table> <p><b>Model No: PE9245</b> 75 Ohm SMB "T" Jack-Plug-Jack</p>	PRICE		1-24	\$42.96	25-49	\$39.95	50-99	\$36.95	100 +	\$34.37	<p><b>75 Ohm SMB Between-Series</b></p> <p>→</p>		 <table border="1"> <thead> <tr> <th colspan="2">PRICE</th> </tr> </thead> <tbody> <tr> <td>1-24</td> <td>\$47.12</td> </tr> <tr> <td>25-49</td> <td>\$43.82</td> </tr> <tr> <td>50-99</td> <td>\$40.52</td> </tr> <tr> <td>100 +</td> <td>\$37.70</td> </tr> </tbody> </table> <p><b>Model No: PE9736</b> 75 Ohm SMB Plug To Mini 75 Ohm SMB Jack</p>	PRICE		1-24	\$47.12	25-49	\$43.82	50-99	\$40.52	100 +	\$37.70									
PRICE																																												
1-24	\$44.23																																											
25-49	\$41.13																																											
50-99	\$38.04																																											
100 +	\$35.38																																											
PRICE																																												
1-24	\$42.96																																											
25-49	\$39.95																																											
50-99	\$36.95																																											
100 +	\$34.37																																											
PRICE																																												
1-24	\$47.12																																											
25-49	\$43.82																																											
50-99	\$40.52																																											
100 +	\$37.70																																											
2	 <table border="1"> <thead> <tr> <th colspan="2">PRICE</th> </tr> </thead> <tbody> <tr> <td>1-24</td> <td>\$47.12</td> </tr> <tr> <td>25-49</td> <td>\$43.82</td> </tr> <tr> <td>50-99</td> <td>\$40.52</td> </tr> <tr> <td>100 +</td> <td>\$37.70</td> </tr> </tbody> </table> <p><b>Model No: PE9735</b> 75 Ohm SMB Jack To Mini 75 Ohm SMB Plug</p>	PRICE		1-24	\$47.12	25-49	\$43.82	50-99	\$40.52	100 +	\$37.70	<p><b>75 Ohm Mini SMB In-Series</b></p> <p>→</p>		 <table border="1"> <thead> <tr> <th colspan="2">PRICE</th> </tr> </thead> <tbody> <tr> <td>1-24</td> <td>\$22.87</td> </tr> <tr> <td>25-49</td> <td>\$21.27</td> </tr> <tr> <td>50-99</td> <td>\$19.67</td> </tr> <tr> <td>100 +</td> <td>\$18.30</td> </tr> </tbody> </table> <p><b>Model No: PE9609</b> Mini 75 Ohm SMB Plug To Mini 75 Ohm SMB Plug</p>	PRICE		1-24	\$22.87	25-49	\$21.27	50-99	\$19.67	100 +	\$18.30	 <table border="1"> <thead> <tr> <th colspan="2">PRICE</th> </tr> </thead> <tbody> <tr> <td>1-24</td> <td>\$35.26</td> </tr> <tr> <td>25-49</td> <td>\$32.79</td> </tr> <tr> <td>50-99</td> <td>\$30.32</td> </tr> <tr> <td>100 +</td> <td>\$28.21</td> </tr> </tbody> </table> <p><b>Model No: PE9610</b> Mini 75 Ohm SMB Plug To Mini 75 Ohm SMB Jack</p>	PRICE		1-24	\$35.26	25-49	\$32.79	50-99	\$30.32	100 +	\$28.21									
PRICE																																												
1-24	\$47.12																																											
25-49	\$43.82																																											
50-99	\$40.52																																											
100 +	\$37.70																																											
PRICE																																												
1-24	\$22.87																																											
25-49	\$21.27																																											
50-99	\$19.67																																											
100 +	\$18.30																																											
PRICE																																												
1-24	\$35.26																																											
25-49	\$32.79																																											
50-99	\$30.32																																											
100 +	\$28.21																																											
3	 <table border="1"> <thead> <tr> <th colspan="2">PRICE</th> </tr> </thead> <tbody> <tr> <td>1-24</td> <td>\$22.87</td> </tr> <tr> <td>25-49</td> <td>\$21.27</td> </tr> <tr> <td>50-99</td> <td>\$19.67</td> </tr> <tr> <td>100 +</td> <td>\$18.30</td> </tr> </tbody> </table> <p><b>Model No: PE9608</b> Mini 75 Ohm SMB Jack To Mini 75 Ohm SMB Jack</p>	PRICE		1-24	\$22.87	25-49	\$21.27	50-99	\$19.67	100 +	\$18.30	 <table border="1"> <thead> <tr> <th colspan="2">PRICE</th> </tr> </thead> <tbody> <tr> <td>1-24</td> <td>\$35.26</td> </tr> <tr> <td>25-49</td> <td>\$32.79</td> </tr> <tr> <td>50-99</td> <td>\$30.32</td> </tr> <tr> <td>100 +</td> <td>\$28.21</td> </tr> </tbody> </table> <p><b>Model No: PE9611</b> Mini 75 Ohm SMB Jack To Mini 75 Ohm SMB Jack Bulkhead Mounting Hole B01</p>	PRICE		1-24	\$35.26	25-49	\$32.79	50-99	\$30.32	100 +	\$28.21	 <table border="1"> <thead> <tr> <th colspan="2">PRICE</th> </tr> </thead> <tbody> <tr> <td>1-24</td> <td>\$58.87</td> </tr> <tr> <td>25-49</td> <td>\$54.75</td> </tr> <tr> <td>50-99</td> <td>\$50.63</td> </tr> <tr> <td>100 +</td> <td>\$47.10</td> </tr> </tbody> </table> <p><b>Model No: PE9616</b> Mini 75 Ohm SMB Plug To 75 Ohm BNC Male</p>	PRICE		1-24	\$58.87	25-49	\$54.75	50-99	\$50.63	100 +	\$47.10	 <table border="1"> <thead> <tr> <th colspan="2">PRICE</th> </tr> </thead> <tbody> <tr> <td>1-24</td> <td>\$45.90</td> </tr> <tr> <td>25-49</td> <td>\$42.69</td> </tr> <tr> <td>50-99</td> <td>\$39.47</td> </tr> <tr> <td>100 +</td> <td>\$36.72</td> </tr> </tbody> </table> <p><b>Model No: PE9617</b> Mini 75 Ohm SMB Plug To 75 Ohm BNC Female</p>	PRICE		1-24	\$45.90	25-49	\$42.69	50-99	\$39.47	100 +	\$36.72
PRICE																																												
1-24	\$22.87																																											
25-49	\$21.27																																											
50-99	\$19.67																																											
100 +	\$18.30																																											
PRICE																																												
1-24	\$35.26																																											
25-49	\$32.79																																											
50-99	\$30.32																																											
100 +	\$28.21																																											
PRICE																																												
1-24	\$58.87																																											
25-49	\$54.75																																											
50-99	\$50.63																																											
100 +	\$47.10																																											
PRICE																																												
1-24	\$45.90																																											
25-49	\$42.69																																											
50-99	\$39.47																																											
100 +	\$36.72																																											
4	 <table border="1"> <thead> <tr> <th colspan="2">PRICE</th> </tr> </thead> <tbody> <tr> <td>1-24</td> <td>\$58.87</td> </tr> <tr> <td>25-49</td> <td>\$54.75</td> </tr> <tr> <td>50-99</td> <td>\$50.63</td> </tr> <tr> <td>100 +</td> <td>\$47.10</td> </tr> </tbody> </table> <p><b>Model No: PE9618</b> Mini 75 Ohm SMB Jack To 75 Ohm BNC Male</p>	PRICE		1-24	\$58.87	25-49	\$54.75	50-99	\$50.63	100 +	\$47.10	 <table border="1"> <thead> <tr> <th colspan="2">PRICE</th> </tr> </thead> <tbody> <tr> <td>1-24</td> <td>\$58.87</td> </tr> <tr> <td>25-49</td> <td>\$54.75</td> </tr> <tr> <td>50-99</td> <td>\$50.63</td> </tr> <tr> <td>100 +</td> <td>\$47.10</td> </tr> </tbody> </table> <p><b>Model No: PE9619</b> Mini 75 Ohm SMB Jack To 75 Ohm BNC Female</p>	PRICE		1-24	\$58.87	25-49	\$54.75	50-99	\$50.63	100 +	\$47.10	<p><b>75 Ohm BNC In-Series</b></p> <p>→</p>		 <table border="1"> <thead> <tr> <th colspan="2">PRICE</th> </tr> </thead> <tbody> <tr> <td>1-24</td> <td>\$16.21</td> </tr> <tr> <td>25-49</td> <td>\$15.08</td> </tr> <tr> <td>50-99</td> <td>\$13.94</td> </tr> <tr> <td>100 +</td> <td>\$12.97</td> </tr> </tbody> </table> <p><b>Model No: PE9364</b> 75 Ohm BNC Male To 75 Ohm BNC Male Mates With 50 Ohm BNC</p>	PRICE		1-24	\$16.21	25-49	\$15.08	50-99	\$13.94	100 +	\$12.97									
PRICE																																												
1-24	\$58.87																																											
25-49	\$54.75																																											
50-99	\$50.63																																											
100 +	\$47.10																																											
PRICE																																												
1-24	\$58.87																																											
25-49	\$54.75																																											
50-99	\$50.63																																											
100 +	\$47.10																																											
PRICE																																												
1-24	\$16.21																																											
25-49	\$15.08																																											
50-99	\$13.94																																											
100 +	\$12.97																																											
5	 <table border="1"> <thead> <tr> <th colspan="2">PRICE</th> </tr> </thead> <tbody> <tr> <td>1-24</td> <td>\$23.15</td> </tr> <tr> <td>25-49</td> <td>\$21.53</td> </tr> <tr> <td>50-99</td> <td>\$19.91</td> </tr> <tr> <td>100 +</td> <td>\$18.52</td> </tr> </tbody> </table> <p><b>Model No: PE9361</b> 75 Ohm BNC Male To 75 Ohm BNC Female Right Angle Mates With 50 Ohm BNC</p>	PRICE		1-24	\$23.15	25-49	\$21.53	50-99	\$19.91	100 +	\$18.52	 <table border="1"> <thead> <tr> <th colspan="2">PRICE</th> </tr> </thead> <tbody> <tr> <td>1-24</td> <td>\$15.66</td> </tr> <tr> <td>25-49</td> <td>\$14.56</td> </tr> <tr> <td>50-99</td> <td>\$13.47</td> </tr> <tr> <td>100 +</td> <td>\$12.53</td> </tr> </tbody> </table> <p><b>Model No: PE9362</b> 75 Ohm BNC Female To 75 Ohm BNC Female Mates With 50 Ohm BNC</p>	PRICE		1-24	\$15.66	25-49	\$14.56	50-99	\$13.47	100 +	\$12.53	 <table border="1"> <thead> <tr> <th colspan="2">PRICE</th> </tr> </thead> <tbody> <tr> <td>1-24</td> <td>\$25.99</td> </tr> <tr> <td>25-49</td> <td>\$24.17</td> </tr> <tr> <td>50-99</td> <td>\$22.35</td> </tr> <tr> <td>100 +</td> <td>\$20.79</td> </tr> </tbody> </table> <p><b>Model No: PE9363</b> 75 Ohm BNC Female To 75 Ohm BNC Female Bulkhead Mates With 50 Ohm BNC Mounting Hole B06</p>	PRICE		1-24	\$25.99	25-49	\$24.17	50-99	\$22.35	100 +	\$20.79	 <table border="1"> <thead> <tr> <th colspan="2">PRICE</th> </tr> </thead> <tbody> <tr> <td>1-24</td> <td>\$27.54</td> </tr> <tr> <td>25-49</td> <td>\$25.61</td> </tr> <tr> <td>50-99</td> <td>\$23.68</td> </tr> <tr> <td>100 +</td> <td>\$22.03</td> </tr> </tbody> </table> <p><b>Model No: PE9366</b> 75 Ohm BNC Female To 75 Ohm BNC Female Bulkhead, Isolated Ground Mates With 50 Ohm BNC Mounting Hole B06</p>	PRICE		1-24	\$27.54	25-49	\$25.61	50-99	\$23.68	100 +	\$22.03
PRICE																																												
1-24	\$23.15																																											
25-49	\$21.53																																											
50-99	\$19.91																																											
100 +	\$18.52																																											
PRICE																																												
1-24	\$15.66																																											
25-49	\$14.56																																											
50-99	\$13.47																																											
100 +	\$12.53																																											
PRICE																																												
1-24	\$25.99																																											
25-49	\$24.17																																											
50-99	\$22.35																																											
100 +	\$20.79																																											
PRICE																																												
1-24	\$27.54																																											
25-49	\$25.61																																											
50-99	\$23.68																																											
100 +	\$22.03																																											
6	 <table border="1"> <thead> <tr> <th colspan="2">PRICE</th> </tr> </thead> <tbody> <tr> <td>1-24</td> <td>\$26.60</td> </tr> <tr> <td>25-49</td> <td>\$24.74</td> </tr> <tr> <td>50-99</td> <td>\$22.88</td> </tr> <tr> <td>100 +</td> <td>\$21.28</td> </tr> </tbody> </table> <p><b>Model No: PE9367</b> 75 Ohm BNC Female To 75 Ohm BNC Female, Panel Mount, Mates With 50 Ohm BNC Mounting Hole A03</p>	PRICE		1-24	\$26.60	25-49	\$24.74	50-99	\$22.88	100 +	\$21.28	 <table border="1"> <thead> <tr> <th colspan="2">PRICE</th> </tr> </thead> <tbody> <tr> <td>1-24</td> <td>\$26.28</td> </tr> <tr> <td>25-49</td> <td>\$24.44</td> </tr> <tr> <td>50-99</td> <td>\$22.60</td> </tr> <tr> <td>100 +</td> <td>\$21.02</td> </tr> </tbody> </table> <p><b>Model No: PE9365</b> 75 Ohm BNC "T" Female-Male- Female Mates With 50 Ohm BNC</p>	PRICE		1-24	\$26.28	25-49	\$24.44	50-99	\$22.60	100 +	\$21.02	<p><b>3/4"-20 Twinax In-Series</b></p> <p>→</p>		 <table border="1"> <thead> <tr> <th colspan="2">PRICE</th> </tr> </thead> <tbody> <tr> <td>1-24</td> <td>\$17.12</td> </tr> <tr> <td>25-49</td> <td>\$15.92</td> </tr> <tr> <td>50-99</td> <td>\$14.72</td> </tr> <tr> <td>100 +</td> <td>\$13.70</td> </tr> </tbody> </table> <p><b>Model No: PE9199</b> 3/4"-20 Twinax Female To 3/4"-20 Twinax Female</p>	PRICE		1-24	\$17.12	25-49	\$15.92	50-99	\$14.72	100 +	\$13.70									
PRICE																																												
1-24	\$26.60																																											
25-49	\$24.74																																											
50-99	\$22.88																																											
100 +	\$21.28																																											
PRICE																																												
1-24	\$26.28																																											
25-49	\$24.44																																											
50-99	\$22.60																																											
100 +	\$21.02																																											
PRICE																																												
1-24	\$17.12																																											
25-49	\$15.92																																											
50-99	\$14.72																																											
100 +	\$13.70																																											

# ADAPTERS

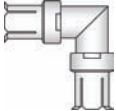
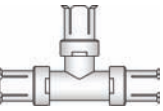
See Adapter Locator on Pages 140-145 or the Adapter Matrix on Pages 138-139

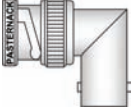
See Page 246 for Mounting Holes

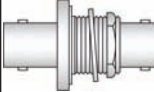
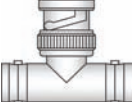
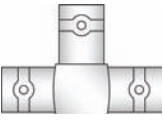
	A	B	C	D																																								
1	 <table border="1"> <thead> <tr> <th colspan="2">PRICE</th> </tr> </thead> <tbody> <tr> <td>1-24</td> <td>\$35.26</td> </tr> <tr> <td>25-49</td> <td>\$32.79</td> </tr> <tr> <td>50-99</td> <td>\$30.32</td> </tr> <tr> <td>100 +</td> <td>\$28.21</td> </tr> </tbody> </table> <p><b>Model No: PE9373</b> 3/4"-20 Twinax Female To 3/4"-20 Twinax Female Bulkhead Mounting Hole B07</p>	PRICE		1-24	\$35.26	25-49	\$32.79	50-99	\$30.32	100 +	\$28.21	 <table border="1"> <thead> <tr> <th colspan="2">PRICE</th> </tr> </thead> <tbody> <tr> <td>1-24</td> <td>\$31.92</td> </tr> <tr> <td>25-49</td> <td>\$29.69</td> </tr> <tr> <td>50-99</td> <td>\$27.45</td> </tr> <tr> <td>100 +</td> <td>\$25.54</td> </tr> </tbody> </table> <p><b>Model No: PE9374</b> 3/4"-20 Twinax "T" Female-Male- Female</p>	PRICE		1-24	\$31.92	25-49	\$29.69	50-99	\$27.45	100 +	\$25.54	 <table border="1"> <thead> <tr> <th colspan="2">PRICE</th> </tr> </thead> <tbody> <tr> <td>1-24</td> <td>\$35.26</td> </tr> <tr> <td>25-49</td> <td>\$32.79</td> </tr> <tr> <td>50-99</td> <td>\$30.32</td> </tr> <tr> <td>100 +</td> <td>\$28.21</td> </tr> </tbody> </table> <p><b>Model No: PE9224</b> 3/4"-20 Twinax "T" Female- Female-Female</p>	PRICE		1-24	\$35.26	25-49	\$32.79	50-99	\$30.32	100 +	\$28.21	<p><b>D Subminiature In-Series</b></p> <p>→</p>										
PRICE																																												
1-24	\$35.26																																											
25-49	\$32.79																																											
50-99	\$30.32																																											
100 +	\$28.21																																											
PRICE																																												
1-24	\$31.92																																											
25-49	\$29.69																																											
50-99	\$27.45																																											
100 +	\$25.54																																											
PRICE																																												
1-24	\$35.26																																											
25-49	\$32.79																																											
50-99	\$30.32																																											
100 +	\$28.21																																											
2	 <table border="1"> <thead> <tr> <th colspan="2">PRICE</th> </tr> </thead> <tbody> <tr> <td>1-24</td> <td>\$41.14</td> </tr> <tr> <td>25-49</td> <td>\$38.26</td> </tr> <tr> <td>50-99</td> <td>\$35.38</td> </tr> <tr> <td>100 +</td> <td>\$32.91</td> </tr> </tbody> </table> <p><b>Model No: PE9688</b> D Subminiature Plug To D Subminiature Plug</p>	PRICE		1-24	\$41.14	25-49	\$38.26	50-99	\$35.38	100 +	\$32.91	 <table border="1"> <thead> <tr> <th colspan="2">PRICE</th> </tr> </thead> <tbody> <tr> <td>1-24</td> <td>\$41.14</td> </tr> <tr> <td>25-49</td> <td>\$38.26</td> </tr> <tr> <td>50-99</td> <td>\$35.38</td> </tr> <tr> <td>100 +</td> <td>\$32.91</td> </tr> </tbody> </table> <p><b>Model No: PE9687</b> D Subminiature Plug To D Subminiature Receptacle</p>	PRICE		1-24	\$41.14	25-49	\$38.26	50-99	\$35.38	100 +	\$32.91	 <table border="1"> <thead> <tr> <th colspan="2">PRICE</th> </tr> </thead> <tbody> <tr> <td>1-24</td> <td>\$41.14</td> </tr> <tr> <td>25-49</td> <td>\$38.26</td> </tr> <tr> <td>50-99</td> <td>\$35.38</td> </tr> <tr> <td>100 +</td> <td>\$32.91</td> </tr> </tbody> </table> <p><b>Model No: PE9689</b> D Subminiature Receptacle To D Subminiature Receptacle</p>	PRICE		1-24	\$41.14	25-49	\$38.26	50-99	\$35.38	100 +	\$32.91	<p><b>GR874 In-Series</b></p> <p>→</p>										
PRICE																																												
1-24	\$41.14																																											
25-49	\$38.26																																											
50-99	\$35.38																																											
100 +	\$32.91																																											
PRICE																																												
1-24	\$41.14																																											
25-49	\$38.26																																											
50-99	\$35.38																																											
100 +	\$32.91																																											
PRICE																																												
1-24	\$41.14																																											
25-49	\$38.26																																											
50-99	\$35.38																																											
100 +	\$32.91																																											
3	 <table border="1"> <thead> <tr> <th colspan="2">PRICE</th> </tr> </thead> <tbody> <tr> <td>1-24</td> <td>\$285.45</td> </tr> <tr> <td>25-49</td> <td>\$265.47</td> </tr> <tr> <td>50-99</td> <td>\$245.49</td> </tr> <tr> <td>100 +</td> <td>\$228.36</td> </tr> </tbody> </table> <p><b>Model No: PE9286</b> GR874 To GR874 Right Angle</p>	PRICE		1-24	\$285.45	25-49	\$265.47	50-99	\$245.49	100 +	\$228.36	 <table border="1"> <thead> <tr> <th colspan="2">PRICE</th> </tr> </thead> <tbody> <tr> <td>1-24</td> <td>\$285.45</td> </tr> <tr> <td>25-49</td> <td>\$265.47</td> </tr> <tr> <td>50-99</td> <td>\$245.49</td> </tr> <tr> <td>100 +</td> <td>\$228.36</td> </tr> </tbody> </table> <p><b>Model No: PE9285</b> GR874 "T"</p>	PRICE		1-24	\$285.45	25-49	\$265.47	50-99	\$245.49	100 +	\$228.36	<p><b>BNC Twinax In-Series</b></p> <p>→</p>	 <table border="1"> <thead> <tr> <th colspan="2">PRICE</th> </tr> </thead> <tbody> <tr> <td>1-24</td> <td>\$38.51</td> </tr> <tr> <td>25-49</td> <td>\$35.81</td> </tr> <tr> <td>50-99</td> <td>\$33.12</td> </tr> <tr> <td>100 +</td> <td>\$30.81</td> </tr> </tbody> </table> <p><b>Model No: PE9376</b> BNC Twinax Plug To BNC Twinax Plug</p>	PRICE		1-24	\$38.51	25-49	\$35.81	50-99	\$33.12	100 +	\$30.81										
PRICE																																												
1-24	\$285.45																																											
25-49	\$265.47																																											
50-99	\$245.49																																											
100 +	\$228.36																																											
PRICE																																												
1-24	\$285.45																																											
25-49	\$265.47																																											
50-99	\$245.49																																											
100 +	\$228.36																																											
PRICE																																												
1-24	\$38.51																																											
25-49	\$35.81																																											
50-99	\$33.12																																											
100 +	\$30.81																																											
4	 <table border="1"> <thead> <tr> <th colspan="2">PRICE</th> </tr> </thead> <tbody> <tr> <td>1-24</td> <td>\$47.73</td> </tr> <tr> <td>25-49</td> <td>\$44.39</td> </tr> <tr> <td>50-99</td> <td>\$41.05</td> </tr> <tr> <td>100 +</td> <td>\$38.18</td> </tr> </tbody> </table> <p><b>Model No: PE9377</b> BNC Twinax Plug To BNC Twinax Jack Right Angle</p>	PRICE		1-24	\$47.73	25-49	\$44.39	50-99	\$41.05	100 +	\$38.18	 <table border="1"> <thead> <tr> <th colspan="2">PRICE</th> </tr> </thead> <tbody> <tr> <td>1-24</td> <td>\$23.36</td> </tr> <tr> <td>25-49</td> <td>\$21.72</td> </tr> <tr> <td>50-99</td> <td>\$20.09</td> </tr> <tr> <td>100 +</td> <td>\$18.69</td> </tr> </tbody> </table> <p><b>Model No: PE9378</b> BNC Twinax Jack To BNC Twinax Jack</p>	PRICE		1-24	\$23.36	25-49	\$21.72	50-99	\$20.09	100 +	\$18.69	 <table border="1"> <thead> <tr> <th colspan="2">PRICE</th> </tr> </thead> <tbody> <tr> <td>1-24</td> <td>\$26.28</td> </tr> <tr> <td>25-49</td> <td>\$24.44</td> </tr> <tr> <td>50-99</td> <td>\$22.60</td> </tr> <tr> <td>100 +</td> <td>\$21.02</td> </tr> </tbody> </table> <p><b>Model No: PE9280</b> BNC Twinax Jack To BNC Twinax Jack Bulkhead Mounting Hole B06</p>	PRICE		1-24	\$26.28	25-49	\$24.44	50-99	\$22.60	100 +	\$21.02	 <table border="1"> <thead> <tr> <th colspan="2">PRICE</th> </tr> </thead> <tbody> <tr> <td>1-24</td> <td>\$34.35</td> </tr> <tr> <td>25-49</td> <td>\$31.95</td> </tr> <tr> <td>50-99</td> <td>\$29.54</td> </tr> <tr> <td>100 +</td> <td>\$27.48</td> </tr> </tbody> </table> <p><b>Model No: PE9375</b> BNC Twinax "T" Jack-Plug-Jack</p>	PRICE		1-24	\$34.35	25-49	\$31.95	50-99	\$29.54	100 +	\$27.48
PRICE																																												
1-24	\$47.73																																											
25-49	\$44.39																																											
50-99	\$41.05																																											
100 +	\$38.18																																											
PRICE																																												
1-24	\$23.36																																											
25-49	\$21.72																																											
50-99	\$20.09																																											
100 +	\$18.69																																											
PRICE																																												
1-24	\$26.28																																											
25-49	\$24.44																																											
50-99	\$22.60																																											
100 +	\$21.02																																											
PRICE																																												
1-24	\$34.35																																											
25-49	\$31.95																																											
50-99	\$29.54																																											
100 +	\$27.48																																											
5	 <table border="1"> <thead> <tr> <th colspan="2">PRICE</th> </tr> </thead> <tbody> <tr> <td>1-24</td> <td>\$40.43</td> </tr> <tr> <td>25-49</td> <td>\$37.60</td> </tr> <tr> <td>50-99</td> <td>\$34.77</td> </tr> <tr> <td>100 +</td> <td>\$32.34</td> </tr> </tbody> </table> <p><b>Model No: PE9279</b> BNC Twinax "T" Jack-Jack-Jack</p>	PRICE		1-24	\$40.43	25-49	\$37.60	50-99	\$34.77	100 +	\$32.34	<p>The world's first commercial cellular network was launched in Japan in 1979.</p>																																
PRICE																																												
1-24	\$40.43																																											
25-49	\$37.60																																											
50-99	\$34.77																																											
100 +	\$32.34																																											

Adapters

See Our Website For Real-Time Stock Availability!

## Notes

# INDEX GUIDE TO COAXIAL CABLES

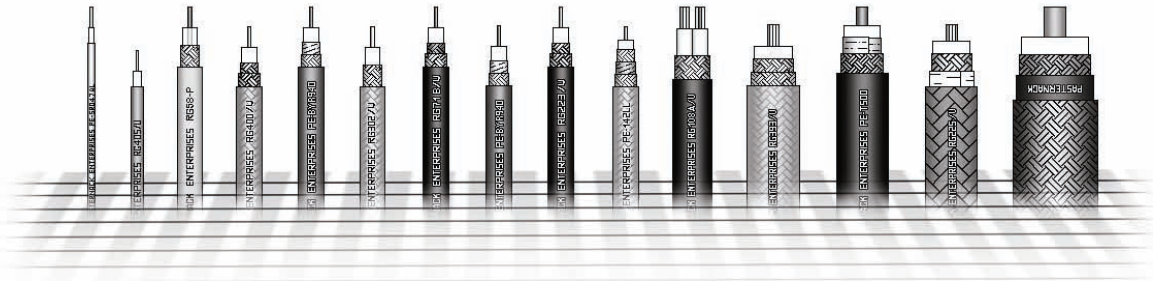

## COAXIAL CABLES.....181

### 75 OHM BROADCAST.....181



Pasternack's selection of 75 Ohm Broadcast coaxial cable includes RG59-P plenum cable, commercial grade RG6-CATV, HD mini 59 cable in multiple colors as well as PTFE jacketed RG187A/U.

### RG MIL-C-17 TYPE CABLE.....182



Pasternack offers 31 different MIL-C-17 compliant coaxial cable types. These cables are available in various diameters, jacket materials, impedances, and velocity factors, providing numerous RF cable options to fit your specific requirements.

### COMMUNICATIONS.....181

Our selection of Low Loss cable is designed with high Velocity Factor (VF) dielectric materials and two outer shields for communications applications requiring Low Loss and High Isolation. These cables are offered in several popular sizes including 0.195", 0.240", 0.400", and 0.600" diameters.



### SEMIRIGID AND FORMABLE.....183

Pasternack's Precision Cables are designed for RF and Microwave applications with frequencies up to 65 GHz. These cables are constructed of copper jacketed and tinned aluminum semirigid designs; and tinned braid conformable cable in both FEP jacketed and unjacketed designs. The semi rigid and conformable cables are available from 0.020 to 0.250 inches in diameter.

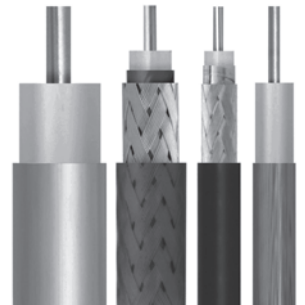

### HIGH PERFORMANCE.....181



Pasternack's line of High Performance Flexible Cable have high Velocity Factors of 70 to 85% and incorporate Spiral Wrapped outer conductors for superior shielding under flexure. These cables are used as flexible cable alternatives to semirigid cable and in many cases use the same connectors.

### TWINAX.....183



Pasternack offers two versions of Twinax cable with an impedance of 100 or 78 ohms. Twinax cable has two center conductors surrounded by a dielectric. The dielectric is surrounded by a braided outer conductor covered by a PVC jacket material. This construction creates a shielded, twisted pair with superior performance when compared to unshielded, twisted pair cable.

# COAXIAL CABLES

MEETS OR EXCEEDS MIL-C-17 SPECIFICATIONS WHERE APPLICABLE

MODEL NO.	COAX IMPEDANCE (Ohm)	JACKET DIAMETER (in)	NUMBER OF SHIELDS	VELOCITY FACTOR (%)	MAX. POWER HANDLING AT 1 GHz (W)	JACKET MATERIAL	PRICE PER FOOT		ROW
	MAXIMUM FREQUENCY (GHz.)	CONDUCTOR DIAM. (in) [strands]	RF SHIELDING (min dB)	LOSS PER FOOT AT 1 GHz. (dB/100 ft)	MAXIMUM OPERATING VOLTAGE (V RMS)	MINIMUM BEND RADIUS (in)	50-99 FT 250-499 FT	100-249 FT 500 + FT	
<b>75 Ohm Broadcast</b>									
PE-B150	75	0.150	1	66	25	PVC	\$0.59	\$0.55	1
	3	0.017 [7]	45	20	600	2	\$0.51	\$0.47	
PE-B159-BK	75	0.159	2	82		PVC	\$1.25	\$1.16	2
	3	0.023	90	12.5	300	1.5	\$1.08	\$1.00	
PE-B159-BL	75	0.159	2	82		PVC	\$1.25	\$1.16	3
	3	0.023	90	12.5	300	1.5	\$1.08	\$1.00	
PE-B159-GR	75	0.159	2	82		PVC	\$1.25	\$1.16	4
	3	0.023	90	12.5	300	1.5	\$1.08	\$1.00	
PE-B159-RD	75	0.159	2	82		PVC	\$1.25	\$1.16	5
	3	0.023	90	12.5	300	1.5	\$1.08	\$1.00	
PE-B159-WH	75	0.159	2	82		PVC	\$1.25	\$1.16	6
	3	0.023	90	12.5	300	1.5	\$1.08	\$1.00	
PE-B159-YW	75	0.159	2	82		PVC	\$1.25	\$1.16	7
	3	0.023	90	12.5	300	1.5	\$1.08	\$1.00	
PE-B305	75	0.305	2	66	52	PVC	\$1.52	\$1.41	8
	0.1	0.031	90	9.2	2900	6	\$1.31	\$1.22	
RG11A/U	75	0.405	1	66	150	PVC	\$1.31	\$1.22	9
	6	.0477 [7]	45	9	5000	4.5	\$1.13	\$1.05	
RG179B/U	75	0.100	1	70	200	FEP	\$1.88	\$1.75	10
	3	0.012 [7]	45	25	1200	1	\$1.62	\$1.50	
RG187A/U	75	0.110	1	70	200	PTFE	\$2.61	\$2.43	11
	3	0.012 [7]	45	25	1200	1	\$2.24	\$2.09	
RG216/U	75	0.425	2	66	150	PVC	\$4.76	\$4.43	12
	5	0.0477 [7]	90	9	5000	4.5	\$4.09	\$3.81	
RG302/U	75	0.206	1	70	650	FEP	\$4.50	\$4.19	13
		0.025	45	13	2300	2	\$3.87	\$3.60	
RG59-P (1)	75	0.194	1	82	880	FEP	\$1.63	\$1.52	14
		0.0253 [7]	45	11	2300	2	\$1.40	\$1.30	
RG59B/U	75	0.242	1	66	77	PVC	\$0.73	\$0.68	15
	5	0.023	45	11.5	2300	2	\$0.63	\$0.58	
RG59-WHITE	75	0.242	1	66	77	PVC	\$1.56	\$1.45	16
	5	0.023	45	11.5	2300	2	\$1.34	\$1.25	
RG6-CATV	75	0.275	3	83	6.5	PVC	\$0.79	\$0.73	17
	1	0.04	110	6.5	350	2.75	\$0.68	\$0.63	
RG6A/U	75	0.332	2	66	125	PVC	\$1.45	\$1.35	18
	1	0.029	90	11	2700	3.5	\$1.25	\$1.16	
<b>Communications</b>									
PE-B400	50	0.403	2	78	190	PVC	\$1.28	\$1.19	19
	4	0.013	90	6	600	4	\$1.10	\$1.02	
PE-B405	50	0.405	2	84	344	PVC	\$2.04	\$1.90	20
	1	0.108	90	4.5	600	6	\$1.75	\$1.63	
PE-C100	50	0.110	2	66	45	PVC	\$1.67	\$1.55	21
	6	0.018	90	23.5	500	1	\$1.44	\$1.34	
PE-C195	50	0.195	2	80	150	PE	\$1.11	\$1.03	22
	6	0.037	90	11.5	1000	2	\$0.95	\$0.89	
PE-C200	50	0.195	2	83	170	PE	\$3.51	\$3.26	23
	6	0.044	90	11	1000	2	\$3.02	\$2.81	
PE-C240	50	0.240	2	84	250	PE	\$2.34	\$2.18	24
	6	0.056	90	8	1500	2.5	\$2.01	\$1.87	
PE-C300	50	0.300	2	85	350	PE	\$2.17	\$2.02	25
	6	0.07	90	6.5	2000	3	\$1.87	\$1.74	
PE-C400	50	0.405	2	85	550	PE	\$4.00	\$3.72	26
	6	0.109	90	4.5	2500	4	\$3.44	\$3.20	
PE-C500	50	0.500	2	86	720	PE	\$3.34	\$3.11	27
	6	0.142	90	3.5	3000	5	\$2.87	\$2.67	
PE-C600	50	0.590	2	87	900	PE	\$4.90	\$4.56	28
	6	0.176	90	3	4000	6	\$4.21	\$3.92	
<b>High Performance</b>									
PE-P047	50	0.056	2	70	43	FEP	\$5.73	\$5.33	29
	20	0.0113	90	35		0.25	\$4.93	\$4.58	

Coaxial Cables

See Our Website For Real-Time Stock Availability!



Free Freight Available  
via UPS Ground  
to USA & Canada



Real-Time Stock  
Levels & Pricing  
On Our WebSite



Toll-Free Technical  
Support  
(866) 727-8376



Same-Day Shipping,  
Even Custom  
Cable Assemblies

# COAXIAL CABLES

MEETS OR EXCEEDS MIL-C-17 SPECIFICATIONS WHERE APPLICABLE

MODEL NO.	COAX IMPEDANCE (Ohm)	JACKET DIAMETER (in)	NUMBER OF SHIELDS	VELOCITY FACTOR (%)	MAX. POWER HANDLING AT 1 GHz (W)	JACKET MATERIAL	PRICE PER FOOT		ROW
	MAXIMUM FREQUENCY (GHz.)	CONDUCTOR DIAM. (in) [strands]	RF SHIELDING (min dB)	LOSS PER FOOT AT 1 GHz. (dB/100 ft)	MAXIMUM OPERATING VOLTAGE (V RMS)	MINIMUM BEND RADIUS (in)	50-99 FT 250-499 FT	100-249 FT 500 + FT	
<b>High Performance</b>									
PE-P047LL	50	0.056	2	87	45	FEP	\$7.88	\$7.33	1
	20	0.0126	45	32		0.35	\$6.78	\$6.30	
PE-P086	50	0.104	2	70	160	FEP	\$4.20	\$3.91	2
	20	0.0201	90	23		0.25	\$3.61	\$3.36	
PE-P086LL	50	0.101	2	85		FEP	\$9.59	\$8.92	3
	18	0.0253	100	16		0.75	\$8.25	\$7.67	
PE-P141	50	0.163	2	70	550	FEP	\$4.82	\$4.48	4
	18	0.037	90	13		1.75	\$4.15	\$3.86	
PE-P141LL	50	0.158	2	85	23	FEP	\$10.16	\$9.45	5
	18	0.0453	100				\$8.74	\$8.13	
PE-P195	50	0.195	3	70	650	FEP	\$6.81	\$6.33	6
	18	0.037	95	12.5	1400	1	\$5.86	\$5.45	
<b>RG Mil-C-17 Type Cable</b>									
RG122/U	50	0.160	1	66	35	PVC	\$2.18	\$2.03	7
	6	0.03 [27]	45	29.2	1900	1.5	\$1.87	\$1.74	
RG141A/U	50	0.190	1	70	650	PTFE (FR)	\$4.96	\$4.61	8
	6	0.039	45	13	1900	2	\$4.27	\$3.97	
RG142B/U	50	0.195	2	69	650	FEP	\$4.14	\$3.85	9
	6	0.039	90	13	1900	2	\$3.56	\$3.31	
RG174A/U	50	0.100	1	70	16	PVC	\$0.43	\$0.40	10
	6	0.0189 [7]	45	31	1500	1	\$0.37	\$0.34	
RG178B/U	50	0.075	1	70	78	FEP	\$0.73	\$0.68	11
	6	0.012 [7]	45	45	1000	1	\$0.63	\$0.58	
RG180B/U	95	0.145	1	70	250	FEP	\$3.06	\$2.85	12
		0.012	45	16.5	1500	1.5	\$2.63	\$2.45	
RG188-DS	50	0.122	2	70	160	PTFE	\$2.61	\$2.43	13
	6	0.0201 [7]	90	30	1200	1	\$2.24	\$2.09	
RG188A/U	50	0.110	1	70	160	PTFE	\$1.69	\$1.57	14
	6	0.0201 [7]	45	30	1200	1	\$1.45	\$1.35	
RG196A/U	50	0.080	1	70	78	PTFE	\$1.04	\$0.97	15
	6	0.012 [7]	45	45	1000	1	\$0.89	\$0.83	
RG213/U	50	0.405	1	66	190	PVC	\$1.24	\$1.15	16
	6	0.0888 [7]	90	9	5000	4.5	\$1.07	\$0.99	
RG214/U	50	0.425	2	66	190	PVC	\$5.75	\$5.35	17
	6	0.0888 [7]	90	9	5000	4.5	\$4.95	\$4.60	
RG217/U	50	0.545	2	66	260	PVC	\$3.52	\$3.27	18
	3	0.106	90	5.8	7000	6	\$3.03	\$2.82	
RG218/U	50	0.870	1	66	560	PVC	\$8.85	\$8.23	19
	1	0.195	45	3.8	11000	9	\$7.61	\$7.08	
RG219/U	50	0.945	1	66	560	PVC	\$34.28	\$31.88	20
	1	0.195	45	3.8	11000	10	\$29.48	\$27.42	
RG223/U	50	0.216	2	66	53	PVC	\$2.21	\$2.06	21
	6	0.035	90	16.5	1900	2	\$1.90	\$1.77	
RG225/U	50	0.430	2	69	1700	PTFE (FR)	\$25.88	\$24.07	22
	6	0.094 [7]	90	7.5	5000	5	\$22.26	\$20.70	
RG303/U	50	0.170	1	70	650	FEP	\$4.40	\$4.09	23
	6	0.039	45	13	1900	1.75	\$3.78	\$3.52	
RG316-DS	50	0.114	2	70	160	FEP	\$2.27	\$2.11	24
	6	0.0201 [7]	90	30	900	1	\$1.95	\$1.82	
RG316/U	50	0.102	1	70	160	FEP	\$2.39	\$2.22	25
	6	0.0201 [7]	45	30	1200	1	\$2.06	\$1.91	
RG393/U	50	0.390	2	70	1700	FEP	\$12.02	\$11.18	26
	6	0.0936 [7]	90	7.5	5000	4	\$10.34	\$9.62	
RG400/U	50	0.195	2	70	650	FEP	\$5.43	\$5.05	27
	6	0.0385 [18]	90	13	1900	2	\$4.67	\$4.34	
RG55B/U	54	0.206	2	66	53	PE	\$1.71	\$1.59	28
	6	0.032	90	16.5	1900	2	\$1.47	\$1.37	
RG58-P (1)	50	0.163	1	68	632	FEP	\$3.84	\$3.57	29
	6	.0355 [19]	45	14	1900	1.5	\$3.30	\$3.07	
RG58C/U	50	0.195	1	66	44	PVC	\$0.54	\$0.50	30
	6	.0355 [19]	45	20	1900	2	\$0.46	\$0.43	

Coaxial Cables

See Our Website For Real-Time Stock Availability!

ROHS & REACH COMPLIANT. CUSTOM-LENGTH CABLE ASSEMBLIES MAY BE ORDERED ON OUR WEBSITE.



# COAXIAL CABLES

MEETS OR EXCEEDS MIL-C-17 SPECIFICATIONS WHERE APPLICABLE

MODEL NO.	COAX IMPEDANCE (Ohm)	JACKET DIAMETER (in)	NUMBER OF SHIELDS	VELOCITY FACTOR (%)	MAX. POWER HANDLING AT 1 GHz (W)	JACKET MATERIAL	PRICE PER FOOT		ROW
	MAXIMUM FREQUENCY (GHz.)	CONDUCTOR DIAM. (in) [strands]	RF SHIELDING (min dB)	LOSS PER FOOT AT 1 GHz. (dB/100 ft)	MAXIMUM OPERATING VOLTAGE (V RMS)	MINIMUM BEND RADIUS (in)	50-99 FT 250-499 FT	100-249 FT 500 + FT	
<b>RG Mil-C-17 Type Cable</b>									
RG62A/U	93	0.242	1	84	77	PVC	\$1.04	\$0.97	1
		0.025	45	8.5	750	2.5	\$0.89	\$0.83	
RG71B/U	93	0.250	2	84	77	PE	\$3.01	\$2.80	2
		0.025	90	8.5	750	2	\$2.59	\$2.41	
RG8A/U	52 6	0.405	1	66	190	PVC	\$2.17	\$2.02	3
		0.072 [7]	45	9	5000	4.5	\$1.87	\$1.74	
RG8X	50 6	0.242	1	80	60	PVC	\$2.34	\$2.18	4
		.056 [19]	45	13.5	2500	2.5	\$2.01	\$1.87	
<b>Semirigid and Formable</b>									
PE-020SR (2,8)	50 250	0.020	1	70	2.9	Cu	\$13.96	\$12.98	5
		0.004	100	85	750	0.25	\$12.01	\$11.17	
PE-034SR (2,8)	50 110	0.034	1	66	10	Cu	\$9.76	\$9.08	6
		0.008	100	60	2000	0.25	\$8.39	\$7.81	
PE-047SR (3,8)	50 100	0.047	1	66	32	Cu	\$7.88	\$7.33	7
		0.011	100	40	1000	0.25	\$6.78	\$6.30	
PE-118SR (2)	50 45	0.118	1	77	500	Cu	\$28.51	\$26.51	8
		0.032	100	12.2	1000	0.25	\$24.52	\$22.81	
PE-SR047AL (3,6)	50 110	0.047	1	70	32	Al (Tn)	\$6.98	\$6.49	9
		0.011	90	41	1000	0.05	\$6.00	\$5.58	
PE-SR047FL (12)	50 40	0.047	1	70	32	Cu (Tn)	\$5.67	\$5.27	10
		0.011	90	40	1000	0.05	\$4.88	\$4.54	
PE-SR401AL (2,7)	50 20	0.250	1	70	1400	Al (Tn)	\$13.96	\$12.98	11
		0.064	90	8	3000	0.5	\$12.01	\$11.17	
PE-SR401FL (11)	50 20	0.250	1	70	1400	Cu (Tn)	\$11.86	\$11.03	12
		0.065	90	7	5000	0.5	\$10.20	\$9.49	
PE-SR402-75 (3,8)	75 36	0.141	1	70	280	Cu	\$7.69	\$7.15	13
		0.02	90	12.5	1500		\$6.61	\$6.15	
PE-SR402AL (3,10)	50 36	0.141	1	70	450	Al (Tn)	\$7.24	\$6.73	14
		0.036	90	13	2500	0.15	\$6.23	\$5.79	
PE-SR402FL (4)	50 36	0.141	1	70	450	Cu (Tn)	\$5.96	\$5.54	15
		0.036	90	12	1900	0.15	\$5.13	\$4.77	
PE-SR402FLJ (13)	50 36	0.141	1	70	450	Cu (Tn)	\$5.80	\$5.39	16
		0.036	90	12	1900	0.15	\$4.99	\$4.64	
PE-SR405AL (3,9)	50 40	0.085	1	70	130	Al (Tn)	\$6.64	\$6.18	17
		0.02	90	23	2000	0.1	\$5.71	\$5.31	
PE-SR405FL (5)	50 40	0.085	1	70	130	Cu (Tn)	\$8.23	\$7.65	18
		0.02	90	22	1500	0.1	\$7.08	\$6.58	
PE-SR405FLJ (14)	50 40	0.085	1	70	130	Cu (Tn)	\$5.95	\$5.53	19
		0.02	90	22	1500	0.1	\$5.12	\$4.76	
RG401/U (2,8)	50 20	0.250	1	70	870	Cu	\$16.91	\$15.73	20
		0.065	90	9.7	3000	0.5	\$14.54	\$13.53	
RG402/U (3,8)	50 36	0.141	1	70	650	Cu	\$5.62	\$5.23	21
		0.036	90	13	2500	0.15	\$4.83	\$4.50	
RG405/U (3,8)	50 10	0.085	1	66	130	Cu	\$5.28	\$4.91	22
		0.02	90	22	2000	0.1	\$4.54	\$4.22	
<b>Twinax</b>									
PE-S330 (TWINAX)	100 0.4	0.330	2	66		PVC	\$2.04	\$1.90	23
		2X 0.037[7]	90		300	3.5	\$1.75	\$1.63	
RG108A/U (TWINAX)	78	0.235	1	66	30	PVC	\$1.82	\$1.69	24
		2X 0.0378[7]	45	26.2	1000	2.5	\$1.57	\$1.46	

**NOTES:**

- (1) P = PLENUM CABLE, NEC 725-2(b) CLASS 2 - **REQUIRES SPECIAL CONNECTORS**
- (2) SEMI-RIGID CABLE, SOLD IN 5 FEET, STRAIGHT PIECES ONLY
- (3) SEMI-RIGID CABLE, SOLD IN EITHER 5 FEET, STRAIGHT PIECES OR COILS OF 50 FEET
- (4) RE-SHAPEABLE VERSION OF RG402/U
- (5) RE-SHAPEABLE VERSION OF RG405/U
- (6) TINNED ALUMINUM VERSION OF PE-047SR
- (7) TINNED ALUMINUM VERSION OF RG401/U
- (8) BARE COPPER JACKET
- (9) TINNED ALUMINUM VERSION OF RG405/U
- (10) TINNED ALUMINUM VERSION OF RG402/U
- (11) RE-SHAPEABLE VERSION OF RG401/U
- (12) RE-SHAPEABLE VERSION OF PE-047SR
- (13) JACKETED RE-SHAPEABLE VERSION OF RG402/U
- (14) JACKETED RE-SHAPEABLE VERSION OF RG405/U

**MATERIALS:**

- Al (Tn) TIN PLATED ALUMINUM
- Cu BARE COPPER
- Cu (Tn) TIN PLATED COPPER
- FEP FLUORINATED ETHYLENE PROPYLENE
- PE POLYETHYLENE
- PTFE POLYTETRAFLUOROETHYLENE
- PTFE (FR) FIBERGLASS REINFORCED PTFE
- PVC POLYVINYLCHLORIDE

Coaxial Cables

See Our Website For Real-Time Stock Availability!

# INDEX GUIDE TO ATTENUATORS, TERMINATIONS, MATCHING PADS, COUPLERS, DIVIDERS AND MISC. RF COMPONENTS

## ATTENUATORS.....185



Pasternack offers fixed and variable attenuator designs to 50 GHz. Fixed RF attenuators are available with various connector options and attenuation levels at power ratings from 1/2 watt to 500 watts. Variable attenuator designs include Continuously Variable Attenuators to 18 GHz. Step Attenuators in Dial, Programmable and Push Button designs in 50 and 75 Ohm designs are selectable with attenuation steps as small as 0.1 dB and attenuation levels to 110 dB.

Continuously Variable Attenuators.....	195	Step Attenuators, Dial.....	192
DC Bias Attenuators.....	194	Step Attenuators, Push Button.....	192
Fixed Attenuators.....	185	Step Attenuators, Toggle.....	193
Programmable Attenuators.....	194		

## COUPLERS AND DIVIDERS.....199

### COUPLERS..... 199

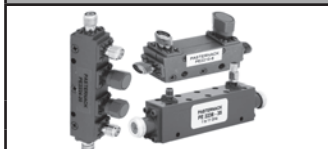

Pasternack offers directional and dual directional couplers in broadband, octave bands, and high power (600 Watt) versions. Coupling values vary from 6 to 35 db. Frequency options are available from 500 MHz to 18 GHz.

Dual Directional.....	201	Single Directional.....	199
Hybrids.....	202		

### DIVIDERS.....202



Pasternack's line of connectorized Power Dividers are available with BNC, SMA, Type N, and 75 ohm BNC connectors. The number of ports vary from 2-way power split to 8-way power split. There is also a 12-way unit available with BNC connectors.

Reactive.....	202	Resistive.....	202
---------------	-----	----------------	-----

## MISC. RF COMPONENTS.....204



Pasternack's Bias Tee's operate up to 50 GHz and current levels to 7 Amps. Our line of DC Blocks are available in 50 and 75 Ohm versions. Circulators and Isolators are offered in octave bands with SMA and N connector versions operating to 26.5 GHz. Connector Caps are available in shorting and non-shorting versions with or without a retaining chain. The broadband coax Surge Protectors use Type N connectors and feature field replaceable discharge cartridges. Bandpass, Lowpass and Highpass Filters have SMA connectors and are available in popular bands, such as WiFi and PCS. Connectorized Phase Trimmers and Shifters operate from DC - 40GHz and are available with SMA or 2.92mm connectors.

Bias Tees.....	206	Filters.....	207
Circulators and Isolators.....	208	Phase Shifters and Trimmers.....	209
Connectors Caps and Shorts.....	204	Surge Protectors.....	210
DC Blocks.....	205		

## TERMINATIONS AND MATCHING PADS.....195

### MATCHING PADS..... 198



Matching pads designed to mate with 50 ohm connectors on one end and 75 ohm connectors on the opposite end are available in a range of connector options.

Resistive Impedance Transformers.....	198
---------------------------------------	-----

### TERMINATIONS..... 195



RF Coaxial Terminations are available in a number of connector options and frequency ranges. Power ratings for these terminations range from 1/2 watt to 500 watts of continuous power. 50 ohm and 75 ohm options are available as well.

Feed-Thru Load.....	198	RF Load.....	195
---------------------	-----	--------------	-----

# ATTENUATORS

## Fixed Attenuators

50 OHM

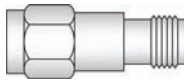

2.92mm

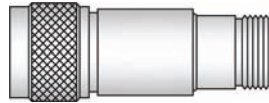

N

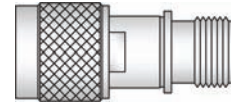

TNC

Max. Power	Connector	Max. Freq. (MHz.)	Construction Material	VSWR Max.	Attenuation (dB)	Model No					ROW
							1-24	25-49	50-99	100+	
0.5 WATT	2.92mm	40,000	Stainless Steel	1.40:1	3	PE7046-3	\$337.18	\$313.58	\$289.97	\$269.74	1
					6	PE7046-6	\$337.18	\$313.58	\$289.97	\$269.74	
					10	PE7046-10	\$337.18	\$313.58	\$289.97	\$269.74	
					20	PE7046-20	\$337.18	\$313.58	\$289.97	\$269.74	
					30	PE7046-30	\$337.18	\$313.58	\$289.97	\$269.74	
1 WATT	SMA	2,000	Stainless Steel	1.20:1	1	PE7161-1	\$42.96	\$39.95	\$36.95	\$34.37	2
					2	PE7161-2	\$42.96	\$39.95	\$36.95	\$34.37	
					3	PE7161-3	\$42.96	\$39.95	\$36.95	\$34.37	
					4	PE7161-4	\$42.96	\$39.95	\$36.95	\$34.37	
					5	PE7161-5	\$42.96	\$39.95	\$36.95	\$34.37	
					6	PE7161-6	\$42.96	\$39.95	\$36.95	\$34.37	
					7	PE7161-7	\$42.96	\$39.95	\$36.95	\$34.37	
					8	PE7161-8	\$42.96	\$39.95	\$36.95	\$34.37	
					9	PE7161-9	\$42.96	\$39.95	\$36.95	\$34.37	
					10	PE7161-10	\$42.96	\$39.95	\$36.95	\$34.37	
					12	PE7161-12	\$42.96	\$39.95	\$36.95	\$34.37	
					15	PE7161-15	\$42.96	\$39.95	\$36.95	\$34.37	
					20	PE7161-20	\$42.96	\$39.95	\$36.95	\$34.37	
					30	PE7161-30	\$42.96	\$39.95	\$36.95	\$34.37	
					40	PE7161-40	\$42.96	\$39.95	\$36.95	\$34.37	
	2.92mm	40,000	Stainless Steel	1.40:1	0	PE7088-0	\$189.50	\$176.24	\$162.97	\$151.60	3
					1	PE7088-1	\$189.50	\$176.24	\$162.97	\$151.60	
					2	PE7088-2	\$189.50	\$176.24	\$162.97	\$151.60	
					3	PE7088-3	\$189.50	\$176.24	\$162.97	\$151.60	
					4	PE7088-4	\$189.50	\$176.24	\$162.97	\$151.60	
					5	PE7088-5	\$189.50	\$176.24	\$162.97	\$151.60	
					6	PE7088-6	\$189.50	\$176.24	\$162.97	\$151.60	
					7	PE7088-7	\$189.50	\$176.24	\$162.97	\$151.60	
					8	PE7088-8	\$189.50	\$176.24	\$162.97	\$151.60	
					9	PE7088-9	\$189.50	\$176.24	\$162.97	\$151.60	
					10	PE7088-10	\$189.50	\$176.24	\$162.97	\$151.60	
					12	PE7088-12	\$189.50	\$176.24	\$162.97	\$151.60	
					15	PE7088-15	\$189.50	\$176.24	\$162.97	\$151.60	
					20	PE7088-20	\$189.50	\$176.24	\$162.97	\$151.60	
					30	PE7088-30	\$189.50	\$176.24	\$162.97	\$151.60	
	2.4mm	50,000	Stainless Steel	1.75:1	3	PE7089-3	\$295.00	\$274.35	\$253.70	\$236.00	4
					6	PE7089-6	\$295.00	\$274.35	\$253.70	\$236.00	
					10	PE7089-10	\$295.00	\$274.35	\$253.70	\$236.00	
					20	PE7089-20	\$295.00	\$274.35	\$253.70	\$236.00	
					30	PE7089-30	\$295.00	\$274.35	\$253.70	\$236.00	
	N	2,000	Nickel Plated Brass	1.25:1	1	PE7002-1	\$56.14	\$52.21	\$48.28	\$44.91	5
					2	PE7002-2	\$56.14	\$52.21	\$48.28	\$44.91	
					3	PE7002-3	\$56.14	\$52.21	\$48.28	\$44.91	
					6	PE7002-6	\$56.14	\$52.21	\$48.28	\$44.91	
					10	PE7002-10	\$56.14	\$52.21	\$48.28	\$44.91	
20					PE7002-20	\$56.14	\$52.21	\$48.28	\$44.91		
30					PE7002-30	\$56.14	\$52.21	\$48.28	\$44.91		
40					PE7002-40	\$72.96	\$67.85	\$62.75	\$58.37		
TNC	2,000	Nickel Plated Brass	1.40:1	1	PE7003-1	\$50.92	\$47.36	\$43.79	\$40.74	6	
				2	PE7003-2	\$50.92	\$47.36	\$43.79	\$40.74		
				3	PE7003-3	\$50.92	\$47.36	\$43.79	\$40.74		
				6	PE7003-6	\$50.92	\$47.36	\$43.79	\$40.74		
				10	PE7003-10	\$50.92	\$47.36	\$43.79	\$40.74		
				20	PE7003-20	\$50.92	\$47.36	\$43.79	\$40.74		
				30	PE7003-30	\$50.92	\$47.36	\$43.79	\$40.74		

Attenuators

See Our Website For Real-Time Stock Availability!

# Fixed Attenuators

50 OHM

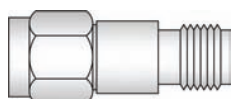

2.92mm



N

Max. Power	Connector	Max. Freq. (MHz.)	Construction Material	VSWR Max.	Attenuation (dB)	Model No	1-24	25-49	50-99	100+	ROW
1 WATT	TNC	2,000	Nickel Plated Brass	1.40:1	40	PE7003-40	\$72.96	\$67.85	\$62.75	\$58.37	6
	BNC			1.20:1	1	PE7000-1	\$33.69	\$31.33	\$28.97	\$26.95	7
				2	PE7000-2	\$33.69	\$31.33	\$28.97	\$26.95		
				3	PE7000-3	\$33.69	\$31.33	\$28.97	\$26.95		
				6	PE7000-6	\$33.69	\$31.33	\$28.97	\$26.95		
				10	PE7000-10	\$33.69	\$31.33	\$28.97	\$26.95		
				20	PE7000-20	\$33.69	\$31.33	\$28.97	\$26.95		
30	PE7000-30	\$44.94	\$41.79	\$38.65	\$35.95						
2 WATT	SMA	3,000	Stainless Steel	1.15:1	1	PE7001-1	\$56.14	\$52.21	\$48.28	\$44.91	8
					2	PE7001-2	\$56.14	\$52.21	\$48.28	\$44.91	
					3	PE7001-3	\$56.14	\$52.21	\$48.28	\$44.91	
					4	PE7001-4	\$56.14	\$52.21	\$48.28	\$44.91	
					5	PE7001-5	\$56.14	\$52.21	\$48.28	\$44.91	
					6	PE7001-6	\$56.14	\$52.21	\$48.28	\$44.91	
					7	PE7001-7	\$56.14	\$52.21	\$48.28	\$44.91	
					8	PE7001-8	\$56.14	\$52.21	\$48.28	\$44.91	
					9	PE7001-9	\$56.14	\$52.21	\$48.28	\$44.91	
					10	PE7001-10	\$56.14	\$52.21	\$48.28	\$44.91	
					12	PE7001-12	\$56.14	\$52.21	\$48.28	\$44.91	
					15	PE7001-15	\$56.14	\$52.21	\$48.28	\$44.91	
					20	PE7001-20	\$56.14	\$52.21	\$48.28	\$44.91	
					30	PE7001-30	\$56.14	\$52.21	\$48.28	\$44.91	
		40	PE7001-40	\$72.96	\$67.85	\$62.75	\$58.37				
		6,000	Brass White Bronze Plated	1.20:1	1	PE7162-1	\$64.45	\$59.94	\$55.43	\$51.56	9
					2	PE7162-2	\$64.45	\$59.94	\$55.43	\$51.56	
					3	PE7162-3	\$64.45	\$59.94	\$55.43	\$51.56	
					4	PE7162-4	\$64.45	\$59.94	\$55.43	\$51.56	
					5	PE7162-5	\$64.45	\$59.94	\$55.43	\$51.56	
					6	PE7162-6	\$64.45	\$59.94	\$55.43	\$51.56	
					7	PE7162-7	\$64.45	\$59.94	\$55.43	\$51.56	
					8	PE7162-8	\$64.45	\$59.94	\$55.43	\$51.56	
					9	PE7162-9	\$64.45	\$59.94	\$55.43	\$51.56	
					10	PE7162-10	\$64.45	\$59.94	\$55.43	\$51.56	
					12	PE7162-12	\$64.45	\$59.94	\$55.43	\$51.56	
					15	PE7162-15	\$64.45	\$59.94	\$55.43	\$51.56	
					20	PE7162-20	\$64.45	\$59.94	\$55.43	\$51.56	
					30	PE7162-30	\$64.45	\$59.94	\$55.43	\$51.56	
		40	PE7162-40	\$64.45	\$59.94	\$55.43	\$51.56				
		12,400	Stainless Steel	1.25:1	1	PE7045-1	\$78.63	\$73.13	\$67.62	\$62.90	10
					2	PE7045-2	\$78.63	\$73.13	\$67.62	\$62.90	
					3	PE7045-3	\$78.63	\$73.13	\$67.62	\$62.90	
					4	PE7045-4	\$78.63	\$73.13	\$67.62	\$62.90	
					5	PE7045-5	\$78.63	\$73.13	\$67.62	\$62.90	
6	PE7045-6				\$78.63	\$73.13	\$67.62	\$62.90			
7	PE7045-7				\$78.63	\$73.13	\$67.62	\$62.90			
8	PE7045-8				\$78.63	\$73.13	\$67.62	\$62.90			
9	PE7045-9				\$78.63	\$73.13	\$67.62	\$62.90			
10	PE7045-10				\$78.63	\$73.13	\$67.62	\$62.90			
12	PE7045-12				\$78.63	\$73.13	\$67.62	\$62.90			
15	PE7045-15				\$78.63	\$73.13	\$67.62	\$62.90			
20	PE7045-20				\$78.63	\$73.13	\$67.62	\$62.90			
30	PE7045-30				\$78.63	\$73.13	\$67.62	\$62.90			
40	PE7045-40	\$101.13	\$94.05	\$86.97	\$80.90						
18,000	Stainless Steel	1.35:1	1	PE7005-1	\$91.60	\$85.19	\$78.78	\$73.28	11		
			2	PE7005-2	\$91.60	\$85.19	\$78.78	\$73.28			
			3	PE7005-3	\$91.60	\$85.19	\$78.78	\$73.28			
			4	PE7005-4	\$91.60	\$85.19	\$78.78	\$73.28			
			5	PE7005-5	\$91.60	\$85.19	\$78.78	\$73.28			
			6	PE7005-6	\$91.60	\$85.19	\$78.78	\$73.28			
			7	PE7005-7	\$91.60	\$85.19	\$78.78	\$73.28			

Attenuators

See Our Website For Real-Time Stock Availability!

# Fixed Attenuators

50 OHM

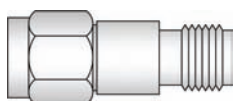

2.92mm

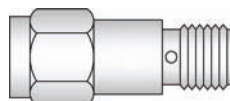

SMA

Max. Power	Connector	Max. Freq. (MHz.)	Construction Material	VSWR Max.	Attenuation (dB)	Model No	1-24	25-49	50-99	100+	ROW
2 WATT	SMA	18,000	Stainless Steel	1.35:1	8	PE7005-8	\$91.60	\$85.19	\$78.78	\$73.28	11
					9	PE7005-9	\$91.60	\$85.19	\$78.78	\$73.28	
					10	PE7005-10	\$91.60	\$85.19	\$78.78	\$73.28	
					12	PE7005-12	\$91.60	\$85.19	\$78.78	\$73.28	
					15	PE7005-15	\$91.60	\$85.19	\$78.78	\$73.28	
					20	PE7005-20	\$91.60	\$85.19	\$78.78	\$73.28	
		30			PE7005-30	\$91.60	\$85.19	\$78.78	\$73.28		
		40			PE7005-40	\$114.60	\$106.58	\$98.56	\$91.68	12	
		0			PE7087-0	\$69.50	\$64.64	\$59.77	\$55.60		
		1			PE7087-1	\$69.50	\$64.64	\$59.77	\$55.60		
		2			PE7087-2	\$69.50	\$64.64	\$59.77	\$55.60		
		3			PE7087-3	\$69.50	\$64.64	\$59.77	\$55.60		
		4			PE7087-4	\$69.50	\$64.64	\$59.77	\$55.60		
		5			PE7087-5	\$69.50	\$64.64	\$59.77	\$55.60		
		6			PE7087-6	\$69.50	\$64.64	\$59.77	\$55.60		
		7			PE7087-7	\$69.50	\$64.64	\$59.77	\$55.60		
		8			PE7087-8	\$69.50	\$64.64	\$59.77	\$55.60		
		9			PE7087-9	\$69.50	\$64.64	\$59.77	\$55.60		
	10	PE7087-10		\$69.50	\$64.64	\$59.77	\$55.60				
	12	PE7087-12		\$69.50	\$64.64	\$59.77	\$55.60				
	15	PE7087-15		\$69.50	\$64.64	\$59.77	\$55.60				
	20	PE7087-20		\$69.50	\$64.64	\$59.77	\$55.60				
	30	PE7087-30		\$69.50	\$64.64	\$59.77	\$55.60	13			
	1	PE7024-1		\$191.06	\$177.69	\$164.31	\$152.85				
	2	PE7024-2		\$191.06	\$177.69	\$164.31	\$152.85				
	3	PE7024-3		\$191.06	\$177.69	\$164.31	\$152.85				
	6	PE7024-6		\$191.06	\$177.69	\$164.31	\$152.85				
	10	PE7024-10		\$191.06	\$177.69	\$164.31	\$152.85				
	20	PE7024-20		\$191.06	\$177.69	\$164.31	\$152.85	14			
	30	PE7024-30		\$191.06	\$177.69	\$164.31	\$152.85				
	3	PE7090-3		\$255.00	\$237.15	\$219.30	\$204.00				
	6	PE7090-6		\$255.00	\$237.15	\$219.30	\$204.00				
	10	PE7090-10		\$255.00	\$237.15	\$219.30	\$204.00				
	15	PE7090-15		\$255.00	\$237.15	\$219.30	\$204.00				
	20	PE7090-20		\$255.00	\$237.15	\$219.30	\$204.00	15			
	30	PE7090-30		\$255.00	\$237.15	\$219.30	\$204.00				
	1	PE7047-1		\$111.31	\$103.52	\$95.73	\$89.05				
	2	PE7047-2		\$111.31	\$103.52	\$95.73	\$89.05				
	3	PE7047-3		\$111.31	\$103.52	\$95.73	\$89.05				
	4	PE7047-4		\$111.31	\$103.52	\$95.73	\$89.05				
	5	PE7047-5		\$111.31	\$103.52	\$95.73	\$89.05				
	6	PE7047-6		\$111.31	\$103.52	\$95.73	\$89.05				
	7	PE7047-7		\$111.31	\$103.52	\$95.73	\$89.05				
	8	PE7047-8		\$111.31	\$103.52	\$95.73	\$89.05				
	9	PE7047-9		\$111.31	\$103.52	\$95.73	\$89.05				
	10	PE7047-10		\$111.31	\$103.52	\$95.73	\$89.05				
	12	PE7047-12		\$111.31	\$103.52	\$95.73	\$89.05				
	15	PE7047-15		\$111.31	\$103.52	\$95.73	\$89.05				
20	PE7047-20	\$111.31	\$103.52	\$95.73	\$89.05						
30	PE7047-30	\$111.31	\$103.52	\$95.73	\$89.05	16					
40	PE7047-40	\$146.12	\$135.89	\$125.66	\$116.90						
1	PE7004-1	\$143.33	\$133.30	\$123.26	\$114.66						
2	PE7004-2	\$143.33	\$133.30	\$123.26	\$114.66						
3	PE7004-3	\$143.33	\$133.30	\$123.26	\$114.66						
4	PE7004-4	\$143.33	\$133.30	\$123.26	\$114.66						
5	PE7004-5	\$143.33	\$133.30	\$123.26	\$114.66						
6	PE7004-6	\$143.33	\$133.30	\$123.26	\$114.66						
7	PE7004-7	\$143.33	\$133.30	\$123.26	\$114.66						
8	PE7004-8	\$143.33	\$133.30	\$123.26	\$114.66						
9	PE7004-9	\$143.33	\$133.30	\$123.26	\$114.66						

Attenuators

See Our Website For Real-Time Stock Availability!



# Fixed Attenuators

50 OHM

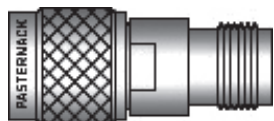

TNC



BNC

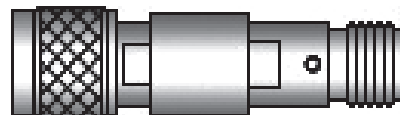

TNC

Max. Power	Connector	Max. Freq. (MHz.)	Construction Material	VSWR Max.	Attenuation (dB)	Model No	1-24	25-49	50-99	100+	ROW				
2 WATT	N	18,000	Stainless Steel	1.35:1	10	PE7004-10	\$143.33	\$133.30	\$123.26	\$114.66	16				
					12	PE7004-12	\$143.33	\$133.30	\$123.26	\$114.66					
					15	PE7004-15	\$143.33	\$133.30	\$123.26	\$114.66					
					20	PE7004-20	\$143.33	\$133.30	\$123.26	\$114.66					
					30	PE7004-30	\$143.33	\$133.30	\$123.26	\$114.66					
					40	PE7004-40	\$162.89	\$151.49	\$140.09	\$130.31					
	TNC	12,400	Nickel Plated Brass	1.25:1	1	PE7051-1	\$101.13	\$94.05	\$86.97	\$80.90	17				
					2	PE7051-2	\$101.13	\$94.05	\$86.97	\$80.90					
					3	PE7051-3	\$101.13	\$94.05	\$86.97	\$80.90					
					6	PE7051-6	\$101.13	\$94.05	\$86.97	\$80.90					
					10	PE7051-10	\$101.13	\$94.05	\$86.97	\$80.90					
					20	PE7051-20	\$101.13	\$94.05	\$86.97	\$80.90					
					30	PE7051-30	\$101.13	\$94.05	\$86.97	\$80.90					
					40	PE7051-40	\$123.57	\$114.92	\$106.27	\$98.86					
					1.35:1	18,000	Stainless Steel	1	PE7030-1	\$202.25		\$188.09	\$173.94	\$161.80	18
								2	PE7030-2	\$202.25		\$188.09	\$173.94	\$161.80	
3	PE7030-3	\$202.25	\$188.09	\$173.94				\$161.80							
6	PE7030-6	\$202.25	\$188.09	\$173.94				\$161.80							
10	PE7030-10	\$202.25	\$188.09	\$173.94				\$161.80							
20	PE7030-20	\$202.25	\$188.09	\$173.94				\$161.80							
30	PE7030-30	\$202.25	\$188.09	\$173.94				\$161.80							
1.20:1	18,000	Stainless Steel	1	PE7023-1				\$393.41	\$365.87	\$338.33	\$314.73	19			
2			PE7023-2	\$393.41	\$365.87	\$338.33	\$314.73								
3			PE7023-3	\$393.41	\$365.87	\$338.33	\$314.73								
6			PE7023-6	\$393.41	\$365.87	\$338.33	\$314.73								
10			PE7023-10	\$393.41	\$365.87	\$338.33	\$314.73								
20			PE7023-20	\$393.41	\$365.87	\$338.33	\$314.73								
30			PE7023-30	\$393.41	\$365.87	\$338.33	\$314.73								
1.25:1			4,000	Nickel Plated Brass	1	PE7049-1	\$78.63	\$73.13	\$67.62	\$62.90	20				
2	PE7049-2	\$78.63			\$73.13	\$67.62	\$62.90								
3	PE7049-3	\$78.63			\$73.13	\$67.62	\$62.90								
6	PE7049-6	\$78.63			\$73.13	\$67.62	\$62.90								
10	PE7049-10	\$78.63			\$73.13	\$67.62	\$62.90								
20	PE7049-20	\$78.63			\$73.13	\$67.62	\$62.90								
30	PE7049-30	\$78.63			\$73.13	\$67.62	\$62.90								
1.25:1	6,000	Brass White Bronze Plated			1	PE7039-1	\$168.56	\$156.76	\$144.96	\$134.85		21			
2					PE7039-2	\$168.56	\$156.76	\$144.96	\$134.85						
3					PE7039-3	\$168.56	\$156.76	\$144.96	\$134.85						
6			PE7039-6	\$168.56	\$156.76	\$144.96	\$134.85								
10			PE7039-10	\$168.56	\$156.76	\$144.96	\$134.85								
20			PE7039-20	\$168.56	\$156.76	\$144.96	\$134.85								
30			PE7039-30	\$168.56	\$156.76	\$144.96	\$134.85								
40			PE7039-40	\$191.06	\$177.69	\$164.31	\$152.85								
5 WATT	7-16 DIN	6,000	Brass White Bronze Plated	1.25:1	1	PE7013-1	\$123.57	\$114.92	\$106.27	\$98.86	22				
					2	PE7013-2	\$123.57	\$114.92	\$106.27	\$98.86					
					3	PE7013-3	\$123.57	\$114.92	\$106.27	\$98.86					
					6	PE7013-6	\$123.57	\$114.92	\$106.27	\$98.86					
					10	PE7013-10	\$123.57	\$114.92	\$106.27	\$98.86					
					20	PE7013-20	\$123.57	\$114.92	\$106.27	\$98.86					
					30	PE7013-30	\$123.57	\$114.92	\$106.27	\$98.86					
					40	PE7013-40	\$146.12	\$135.89	\$125.66	\$116.90					
	SMA	18,000	Aluminum Heatsink	1.40:1	1	PE7014-1	\$202.25	\$188.09	\$173.94	\$161.80	23				
					2	PE7014-2	\$202.25	\$188.09	\$173.94	\$161.80					
					3	PE7014-3	\$202.25	\$188.09	\$173.94	\$161.80					
					6	PE7014-6	\$202.25	\$188.09	\$173.94	\$161.80					
					10	PE7014-10	\$202.25	\$188.09	\$173.94	\$161.80					
					20	PE7014-20	\$202.25	\$188.09	\$173.94	\$161.80					
					30	PE7014-30	\$202.25	\$188.09	\$173.94	\$161.80					
					40	PE7014-40	\$224.75	\$209.02	\$193.29	\$179.80					
N	18,000	Aluminum Heatsink	1.35:1	1	PE7052-1	\$224.75	\$209.02	\$193.29	\$179.80	24					
				2	PE7052-2	\$224.75	\$209.02	\$193.29	\$179.80						
				3	PE7052-3	\$224.75	\$209.02	\$193.29	\$179.80						
				6	PE7052-6	\$224.75	\$209.02	\$193.29	\$179.80						
				10	PE7052-10	\$224.75	\$209.02	\$193.29	\$179.80						
				20	PE7052-20	\$224.75	\$209.02	\$193.29	\$179.80						
				30	PE7052-30	\$224.75	\$209.02	\$193.29	\$179.80						
				TNC	18,000	Aluminum Heatsink	1.35:1	1	PE7052-1		\$224.75	\$209.02	\$193.29	\$179.80	24
2	PE7052-2	\$224.75	\$209.02	\$193.29				\$179.80							
3	PE7052-3	\$224.75	\$209.02	\$193.29				\$179.80							
6	PE7052-6	\$224.75	\$209.02	\$193.29				\$179.80							
10	PE7052-10	\$224.75	\$209.02	\$193.29				\$179.80							
20	PE7052-20	\$224.75	\$209.02	\$193.29				\$179.80							
30	PE7052-30	\$224.75	\$209.02	\$193.29				\$179.80							

Attenuators

See Our Website For Real-Time Stock Availability!

# Fixed Attenuators

50 OHM

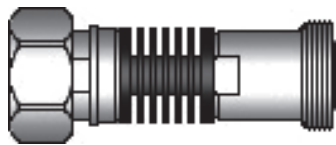

7-16 DIN



N



SMA

Max. Power	Connector	Max. Freq. (MHz.)	Construction Material	VSWR Max.	Attenuation (dB)	Model No	1-24	25-49	50-99	100+	ROW
10 WATT	7-16 DIN	7,500	Aluminum Heatsink	1.45:1	1	PE7040-1	\$247.25	\$229.94	\$212.64	\$197.80	25
					2	PE7040-2	\$247.25	\$229.94	\$212.64	\$197.80	
					3	PE7040-3	\$247.25	\$229.94	\$212.64	\$197.80	
					6	PE7040-6	\$247.25	\$229.94	\$212.64	\$197.80	
					10	PE7040-10	\$247.25	\$229.94	\$212.64	\$197.80	
					20	PE7040-20	\$247.25	\$229.94	\$212.64	\$197.80	
					30	PE7040-30	\$247.25	\$229.94	\$212.64	\$197.80	
					40	PE7040-40	\$269.74	\$250.86	\$231.98	\$215.79	
	SMA	18,000		1.40:1	1	PE7016-1	\$258.49	\$240.40	\$222.30	\$206.79	26
					2	PE7016-2	\$258.49	\$240.40	\$222.30	\$206.79	
					3	PE7016-3	\$258.49	\$240.40	\$222.30	\$206.79	
					6	PE7016-6	\$258.49	\$240.40	\$222.30	\$206.79	
					10	PE7016-10	\$258.49	\$240.40	\$222.30	\$206.79	
					20	PE7016-20	\$258.49	\$240.40	\$222.30	\$206.79	
					30	PE7016-30	\$258.49	\$240.40	\$222.30	\$206.79	
					40	PE7016-40	\$280.99	\$261.32	\$241.65	\$224.79	
	N	2,000		1.20:1	2	PE7010-2	\$168.56	\$156.76	\$144.96	\$134.85	27
					3	PE7010-3	\$168.56	\$156.76	\$144.96	\$134.85	
					6	PE7010-6	\$168.56	\$156.76	\$144.96	\$134.85	
					10	PE7010-10	\$204.38	\$190.07	\$175.77	\$163.50	
		12,400		1.35:1	1	PE7048-1	\$258.49	\$240.40	\$222.30	\$206.79	28
					2	PE7048-2	\$258.49	\$240.40	\$222.30	\$206.79	
					3	PE7048-3	\$258.49	\$240.40	\$222.30	\$206.79	
					6	PE7048-6	\$258.49	\$240.40	\$222.30	\$206.79	
	TNC	18,000		1.40:1	10	PE7048-10	\$258.49	\$240.40	\$222.30	\$206.79	29
					20	PE7048-20	\$258.49	\$240.40	\$222.30	\$206.79	
					30	PE7048-30	\$258.49	\$240.40	\$222.30	\$206.79	
					40	PE7048-40	\$280.99	\$261.32	\$241.65	\$224.79	
					1	PE7015-1	\$280.99	\$261.32	\$241.65	\$224.79	
					2	PE7015-2	\$280.99	\$261.32	\$241.65	\$224.79	
					3	PE7015-3	\$280.99	\$261.32	\$241.65	\$224.79	
					6	PE7015-6	\$280.99	\$261.32	\$241.65	\$224.79	
	BNC	2,000		1.60:1	10	PE7015-10	\$286.56	\$266.50	\$246.44	\$229.25	30
					20	PE7015-20	\$286.56	\$266.50	\$246.44	\$229.25	
					30	PE7015-30	\$286.56	\$266.50	\$246.44	\$229.25	
					40	PE7015-40	\$303.43	\$282.19	\$260.95	\$242.74	
					1	PE7053-1	\$337.18	\$313.58	\$289.97	\$269.74	
					2	PE7053-2	\$337.18	\$313.58	\$289.97	\$269.74	
					3	PE7053-3	\$337.18	\$313.58	\$289.97	\$269.74	
					6	PE7053-6	\$337.18	\$313.58	\$289.97	\$269.74	
7-16 DIN	7,500	1.60:1	10	PE7053-10	\$337.18	\$313.58	\$289.97	\$269.74	31		
			20	PE7053-20	\$337.18	\$313.58	\$289.97	\$269.74			
			30	PE7053-30	\$337.18	\$313.58	\$289.97	\$269.74			
			40	PE7053-40	\$370.87	\$344.91	\$318.95	\$296.70			
			2	PE7025-2	\$213.50	\$198.56	\$183.61	\$170.80			
			3	PE7025-3	\$213.50	\$198.56	\$183.61	\$170.80			
			6	PE7025-6	\$213.50	\$198.56	\$183.61	\$170.80			
			10	PE7025-10	\$213.50	\$198.56	\$183.61	\$170.80			
SMA	18,000	1.40:1	20	PE7025-20	\$213.50	\$198.56	\$183.61	\$170.80	32		
			30	PE7025-30	\$213.50	\$198.56	\$183.61	\$170.80			
			40	PE7025-40	\$247.25	\$229.94	\$212.64	\$197.80			
			1	PE7041-1	\$393.41	\$365.87	\$338.33	\$314.73			
			2	PE7041-2	\$393.41	\$365.87	\$338.33	\$314.73			
			3	PE7041-3	\$393.41	\$365.87	\$338.33	\$314.73			
			6	PE7041-6	\$393.41	\$365.87	\$338.33	\$314.73			
			10	PE7041-10	\$393.41	\$365.87	\$338.33	\$314.73			
25 WATT	7-16 DIN	7,500	Aluminum Heatsink	DC - 4,000: 1.25:1 4,000 - 7,500: 1.45:1	20	PE7041-20	\$393.41	\$365.87	\$338.33	\$314.73	33
					30	PE7041-30	\$393.41	\$365.87	\$338.33	\$314.73	
25 WATT	SMA	18,000	Aluminum Heatsink	1.40:1	40	PE7041-40	\$415.81	\$386.70	\$357.60	\$332.65	33
					1	PE7018-1	\$393.41	\$365.87	\$338.33	\$314.73	
25 WATT	SMA	18,000	Aluminum Heatsink	1.40:1	2	PE7018-2	\$393.41	\$365.87	\$338.33	\$314.73	33

Attenuators

See Our Website For Real-Time Stock Availability!



# Fixed Attenuators

50 OHM

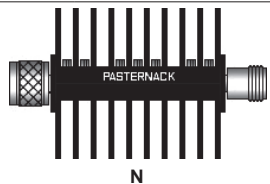

N

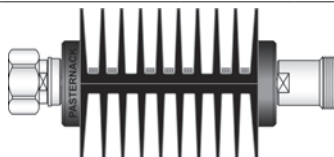

7-16 DIN

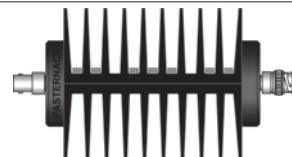

BNC

Attenuators

See Our Website For Real-Time Stock Availability!

Max. Power	Connector	Max. Freq. (MHz.)	Construction Material	VSWR Max.	Attenuation (dB)	Model No	1-24	25-49	50-99	100+	ROW	
25 WATT	SMA	18,000	Aluminum Heatsink	1.40:1	3	PE7018-3	\$393.41	\$365.87	\$338.33	\$314.73	33	
					6	PE7018-6	\$393.41	\$365.87	\$338.33	\$314.73		
					10	PE7018-10	\$393.41	\$365.87	\$338.33	\$314.73		
					20	PE7018-20	\$393.41	\$365.87	\$338.33	\$314.73		
					30	PE7018-30	\$393.41	\$365.87	\$338.33	\$314.73		
					40	PE7018-40	\$415.81	\$386.70	\$357.60	\$332.65		
	N				1	PE7017-1	\$393.41	\$365.87	\$338.33	\$314.73	34	
					2	PE7017-2	\$393.41	\$365.87	\$338.33	\$314.73		
					3	PE7017-3	\$393.41	\$365.87	\$338.33	\$314.73		
					6	PE7017-6	\$393.41	\$365.87	\$338.33	\$314.73		
					10	PE7017-10	\$393.41	\$365.87	\$338.33	\$314.73		
					20	PE7017-20	\$393.41	\$365.87	\$338.33	\$314.73		
	TNC				10	30	PE7017-30	\$393.41	\$365.87	\$338.33	\$314.73	35
						40	PE7017-40	\$449.60	\$418.13	\$386.66	\$359.68	
						1	PE7054-1	\$483.34	\$449.51	\$415.67	\$386.67	
						2	PE7054-2	\$483.34	\$449.51	\$415.67	\$386.67	
6		3	PE7054-3	\$483.34	\$449.51	\$415.67	\$386.67					
		6	PE7054-6	\$483.34	\$449.51	\$415.67	\$386.67					
10		10	PE7054-10	\$483.34	\$449.51	\$415.67	\$386.67					
		20	PE7054-20	\$483.34	\$449.51	\$415.67	\$386.67					
30		30	PE7054-30	\$483.34	\$449.51	\$415.67	\$386.67					
		40	PE7054-40	\$505.79	\$470.38	\$434.98	\$404.63					
50 WATT	7-16 DIN	7,500	Aluminum Heatsink	1.40:1	6	PE7042-6	\$449.60	\$418.13	\$386.66	\$359.68	36	
					10	PE7042-10	\$449.60	\$418.13	\$386.66	\$359.68		
					1.45:1	20	PE7042-20	\$449.60	\$418.13	\$386.66		\$359.68
					30	PE7042-30	\$449.60	\$418.13	\$386.66	\$359.68		
					1.40:1	40	PE7042-40	\$449.60	\$418.13	\$386.66		\$359.68
					6	PE7020-6	\$460.80	\$428.54	\$396.29	\$368.64		
	SMA	18,000		1.45:1	10	PE7020-10	\$460.80	\$428.54	\$396.29	\$368.64	37	
					20	PE7020-20	\$460.80	\$428.54	\$396.29	\$368.64		
					30	PE7020-30	\$460.80	\$428.54	\$396.29	\$368.64		
					40	PE7020-40	\$483.34	\$449.51	\$415.67	\$386.67		
					6	PE7019-6	\$449.60	\$418.13	\$386.66	\$359.68		
					10	PE7019-10	\$449.60	\$418.13	\$386.66	\$359.68		
N	18,000	1.45:1	20	PE7019-20	\$449.60	\$418.13	\$386.66	\$359.68	38			
			30	PE7019-30	\$458.57	\$426.47	\$394.37	\$366.86				
			40	PE7019-40	\$505.79	\$470.38	\$434.98	\$404.63				
			6	PE7055-6	\$561.98	\$522.64	\$483.30	\$449.58				
			10	PE7055-10	\$561.98	\$522.64	\$483.30	\$449.58				
			20	PE7055-20	\$561.98	\$522.64	\$483.30	\$449.58				
TNC	18,000	1.45:1	30	PE7055-30	\$561.98	\$522.64	\$483.30	\$449.58	39			
			40	PE7055-40	\$584.47	\$543.56	\$502.64	\$467.58				
			6	PE7043-6	\$505.79	\$470.38	\$434.98	\$404.63				
			10	PE7043-10	\$505.79	\$470.38	\$434.98	\$404.63				
			20	PE7043-20	\$505.79	\$470.38	\$434.98	\$404.63				
			30	PE7043-30	\$505.79	\$470.38	\$434.98	\$404.63				
100 WATT	7-16 DIN	1,500	Aluminum Heatsink	1.25:1	40	PE7043-40	\$505.79	\$470.38	\$434.98	\$404.63	40	
					6	PE7022-6	\$618.21	\$574.94	\$531.66	\$494.57		
					10	PE7022-10	\$618.21	\$574.94	\$531.66	\$494.57		
					20	PE7022-20	\$618.21	\$574.94	\$531.66	\$494.57		
					30	PE7022-30	\$618.21	\$574.94	\$531.66	\$494.57		
					40	PE7022-40	\$640.71	\$595.86	\$551.01	\$512.57		
	SMA	1,500		1.25:1	6	PE7021-6	\$561.98	\$522.64	\$483.30	\$449.58	41	
					10	PE7021-10	\$561.98	\$522.64	\$483.30	\$449.58		
					20	PE7021-20	\$561.98	\$522.64	\$483.30	\$449.58		
					30	PE7021-30	\$561.98	\$522.64	\$483.30	\$449.58		
					40	PE7021-40	\$618.21	\$574.94	\$531.66	\$494.57		
					6	PE7056-6	\$674.35	\$627.15	\$579.94	\$539.48		
N	1,500	1.40:1	10	PE7056-10	\$674.35	\$627.15	\$579.94	\$539.48	42			
			20	PE7056-20	\$674.35	\$627.15	\$579.94	\$539.48				
			30	PE7056-30	\$674.35	\$627.15	\$579.94	\$539.48				
			40	PE7056-40	\$696.90	\$648.12	\$599.33	\$557.52				
			6	PE7026-3	\$618.21	\$574.94	\$531.66	\$494.57				
			3	PE7026-3	\$618.21	\$574.94	\$531.66	\$494.57				
TNC	1,500	1.40:1	10	PE7056-10	\$674.35	\$627.15	\$579.94	\$539.48	43			
			20	PE7056-20	\$674.35	\$627.15	\$579.94	\$539.48				
			30	PE7056-30	\$674.35	\$627.15	\$579.94	\$539.48				
			40	PE7056-40	\$696.90	\$648.12	\$599.33	\$557.52				
			6	PE7056-6	\$674.35	\$627.15	\$579.94	\$539.48				
			10	PE7056-10	\$674.35	\$627.15	\$579.94	\$539.48				
BNC	1,000	1.40:1	3	PE7026-3	\$618.21	\$574.94	\$531.66	\$494.57	44			

ROHS & REACH COMPLIANT. CUSTOM-LENGTH CABLE ASSEMBLIES MAY BE ORDERED ON OUR WEBSITE.

# Fixed Attenuators

## 50 OHM

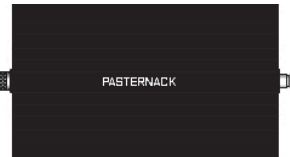

N

N

Max. Power	Connector	Max. Freq. (MHz.)	Construction Material	VSWR Max.	Attenuation (dB)	Model No	1-24	25-49	50-99	100+	ROW
100 WATT	BNC	1,000	Aluminum Heatsink	1.40:1	6	PE7026-6	\$618.21	\$574.94	\$531.66	\$494.57	44
					10	PE7026-10	\$618.21	\$574.94	\$531.66	\$494.57	
					20	PE7026-20	\$618.21	\$574.94	\$531.66	\$494.57	
					30	PE7026-30	\$618.21	\$574.94	\$531.66	\$494.57	
					40	PE7026-40	\$669.89	\$623.00	\$576.11	\$535.91	
300 WATT	N	1,000	Aluminum Heatsink	1.40:1	2	PE7031-2	\$1,455.66	\$1,353.76	\$1,251.87	\$1,164.53	45
					3	PE7031-3	\$1,455.66	\$1,353.76	\$1,251.87	\$1,164.53	
					6	PE7031-6	\$1,455.66	\$1,353.76	\$1,251.87	\$1,164.53	
					10	PE7031-10	\$1,455.66	\$1,353.76	\$1,251.87	\$1,164.53	
					20	PE7031-20	\$1,455.66	\$1,353.76	\$1,251.87	\$1,164.53	
					30	PE7031-30	\$1,455.66	\$1,353.76	\$1,251.87	\$1,164.53	
500 WATT	N	500	Aluminum Heatsink	1.15:1	2	PE7032-2	\$1,686.08	\$1,568.05	\$1,450.03	\$1,348.86	46
					3	PE7085-3	\$1,720.58	\$1,600.14	\$1,479.70	\$1,376.46	
					6	PE7032-6	\$1,686.08	\$1,568.05	\$1,450.03	\$1,348.86	
					10	PE7032-10	\$1,686.08	\$1,568.05	\$1,450.03	\$1,348.86	
					20	PE7032-20	\$1,686.08	\$1,568.05	\$1,450.03	\$1,348.86	
					30	PE7032-30	\$1,686.08	\$1,568.05	\$1,450.03	\$1,348.86	

## 75 OHM

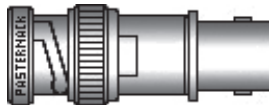

N

BNC

F

Max. Power	Connector	Max. Freq. (MHz.)	Construction Material	VSWR Max.	Attenuation (dB)	Model No	1-24	25-49	50-99	100+	ROW			
1 WATT	N	1,000	Nickel Plated Brass	1.30:1	1	PE7029-1	\$56.14	\$52.21	\$48.28	\$44.91	47			
					2	PE7029-2	\$56.14	\$52.21	\$48.28	\$44.91				
					3	PE7029-3	\$56.14	\$52.21	\$48.28	\$44.91				
					6	PE7029-6	\$56.14	\$52.21	\$48.28	\$44.91				
					10	PE7029-10	\$56.14	\$52.21	\$48.28	\$44.91				
	BNC				1	PE7009-1	\$39.27	\$36.52	\$33.77	\$31.42		48		
					2	PE7009-2	\$39.27	\$36.52	\$33.77	\$31.42				
					3	PE7009-3	\$39.27	\$36.52	\$33.77	\$31.42				
					6	PE7009-6	\$39.27	\$36.52	\$33.77	\$31.42				
					10	PE7009-10	\$39.27	\$36.52	\$33.77	\$31.42				
2 WATT	N	4,000	Nickel Plated Brass	1.30:1	1	PE7044-1	\$112.32	\$104.46	\$96.60	\$89.86	49			
					2	PE7044-2	\$112.32	\$104.46	\$96.60	\$89.86				
					3	PE7044-3	\$112.32	\$104.46	\$96.60	\$89.86				
					6	PE7044-6	\$112.32	\$104.46	\$96.60	\$89.86				
					10	PE7044-10	\$112.32	\$104.46	\$96.60	\$89.86				
					20	PE7044-20	\$112.32	\$104.46	\$96.60	\$89.86				
	F	1,000			1	PE7057-1	\$72.96	\$67.85	\$62.75	\$58.37	50			
					2	PE7057-2	\$72.96	\$67.85	\$62.75	\$58.37				
					3	PE7057-3	\$72.96	\$67.85	\$62.75	\$58.37				
					6	PE7057-6	\$72.96	\$67.85	\$62.75	\$58.37				
					10	PE7057-10	\$72.96	\$67.85	\$62.75	\$58.37				
					BNC	4,000	1	PE7050-1	\$101.13	\$94.05		\$86.97	\$80.90	51
							2	PE7050-2	\$101.13	\$94.05		\$86.97	\$80.90	
							3	PE7050-3	\$101.13	\$94.05		\$86.97	\$80.90	
							6	PE7050-6	\$101.13	\$94.05		\$86.97	\$80.90	
10	PE7050-10	\$101.13	\$94.05	\$86.97			\$80.90							
20	PE7050-20	\$101.13	\$94.05	\$86.97			\$80.90							
30	PE7050-30	\$101.13	\$94.05	\$86.97	\$80.90									

Attenuators

See Our Website For Real-Time Stock Availability!



Free Freight Available via UPS Ground to USA & Canada



Real-Time Stock Levels & Pricing On Our WebSite



Toil-Free Technical Support (866) 727-8376



Same-Day Shipping, Even Custom Cable Assemblies

# Step Attenuators, Push Button

50 OHM



BNC

Max. Power	Connector	Max. Frequency (MHz.)	Construction Material	VSWR Max. (MHz)	Attenuation Range (dB)	Step Size (dB)	Model No	1-24	25-49	50-99	100+	ROW
1 WATT	BNC	750	Nickel Plated Brass	DC - 100: 1.10:1 100 - 500: 1.25:1 500 - 750: 1.40:1	0 - 45.5	0.5	PE7008-1	\$672.32	\$625.26	\$578.20	\$537.86	52
2 WATT	BNC	750	Nickel Plated Brass	DC - 100: 1.10:1 100 - 500: 1.25:1 500 - 750: 1.40:1	0 - 45.5	0.5	PE7008-2	\$686.76	\$638.69	\$590.61	\$549.41	
3 WATT	BNC	750	Nickel Plated Brass	DC - 100: 1.10:1 100 - 300: 1.20:1 300 - 500: 1.30:1	0 - 45.5	0.5	PE7008-3	\$672.32	\$625.26	\$578.20	\$537.86	
4 WATT	BNC	750	Nickel Plated Brass	DC - 100: 1.10:1 100 - 300: 1.20:1 300 - 500: 1.30:1	0 - 45.5	0.5	PE7008-4	\$672.32	\$625.26	\$578.20	\$537.86	
5 WATT	BNC	750	Nickel Plated Brass	1.40:1	0 - 45.5	0.5	PE7008-5	\$859.84	\$799.65	\$739.46	\$687.87	
6 WATT	BNC	750	Nickel Plated Brass	1.40:1	0 - 45.5	0.5	PE7008-6	\$859.84	\$799.65	\$739.46	\$687.87	

Attenuators

# Step Attenuators, Dial

50 OHM

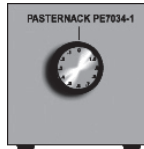

BNC

Max. Power	Connector	Max. Frequency (MHz.)	Construction Material	VSWR Max. (MHz)	Attenuation Range (dB)	Step Size (dB)	Model No	1-24	25-49	50-99	100+	ROW	
1 WATT	BNC	1,000	Aluminum	1.20:1	0 - 1	0.1	PE7034-1	\$321.47	\$298.97	\$276.46	\$257.18	53	
			Nickel Plated Brass	DC - 30: 1.10:1 30 - 500: 1.30:1 500 - 1,000: 1.50:1	0 - 81	0.1	PE7058-1	\$1,375.61	\$1,279.32	\$1,183.02	\$1,100.49	54	
			Aluminum	1.20:1	0 - 100	10	PE7034-2	\$393.41	\$365.87	\$338.33	\$314.73	55	
				1.30:1	0 - 1	0.1	PE7034-6	\$370.87	\$344.91	\$318.95	\$296.70		
		2,000	Aluminum	2,000	DC - 1,000: 1.20:1 1,000 - 2,000: 1.40:1	0 - 10	1	PE7034-3	\$311.89	\$290.06	\$268.23	\$249.51	56
					0 - 70	10	PE7034-4	\$421.79	\$392.26	\$362.74	\$337.43		
					DC - 1,000: 1.30:1 1,000 - 1,500: 1.50:1 1,500 - 2,000: 1.70:1	0 - 80	1	PE7033-2	\$688.33	\$640.15	\$591.96	\$550.66	
					DC - 1,000: 1.30:1 1,000 - 2,000: 1.50:1	0 - 100	10	PE7034-5	\$527.42	\$490.50	\$453.58	\$421.94	
			DC - 1,000: 1.30:1 1,000 - 1,500: 1.50:1 1,500 - 2,000: 1.70:1	0 - 110	1	PE7033	\$749.94	\$697.44	\$644.95	\$599.95	58		

See Our Website For Real-Time Stock Availability!



## Step Attenuators, Dial

75 OHM

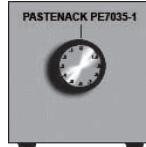

BNC

Max. Power	Connector	Max. Frequency (MHz.)	Construction Material	VSWR Max. (MHz)	Attenuation Range (dB)	Step Size (dB)	Model No	1-24	25-49	50-99	100+	ROW
1 WATT	BNC	500	Aluminum	1.30:1	0 - 1	0.1	PE7035-1	\$337.18	\$313.58	\$289.97	\$269.74	59
					0 - 10	1	PE7035-2	\$337.18	\$313.58	\$289.97	\$269.74	
					0 - 70	10	PE7035-3	\$337.18	\$313.58	\$289.97	\$269.74	
		1,000		DC - 500: 1.30:1 500 - 1,000: 1.40:1	0 - 1	0.1	PE7035-5	\$347.66	\$323.32	\$298.99	\$278.13	
				DC - 500: 1.30:1 500 - 1,000: 1.40:1	0 - 10	1	PE7035-4	\$347.66	\$323.32	\$298.99	\$278.13	

## Step Attenuators, Toggle

50 OHM

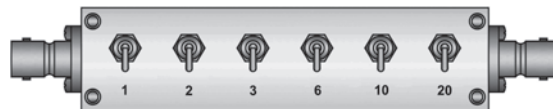

BNC

Max. Power	Connector	Max. Frequency (MHz.)	Construction Material	VSWR Max. (MHz)	Attenuation Range (dB)	Step Size (dB)	Model No	1-24	25-49	50-99	100+	ROW
1 WATT	BNC	500	Aluminum	1.50:1	0 - 42	1	PE7037-1	\$1,721.09	\$1,600.61	\$1,480.14	\$1,376.87	60
					0 - 82.5	0.5	PE7037-2	\$2,023.31	\$1,881.68	\$1,740.05	\$1,618.65	
					0 - 42	0.5	PE7036-1	\$672.32	\$625.26	\$578.20	\$537.86	
		1,000		0 - 82.5	0.5	PE7036-2	\$672.32	\$625.26	\$578.20	\$537.86	61	
				0 - 102	1	PE7036-3	\$681.24	\$633.55	\$585.87	\$544.99		

75 OHM



BNC

Max. Power	Connector	Max. Frequency (MHz.)	Construction Material	VSWR Max. (MHz)	Attenuation Range (dB)	Step Size (dB)	Model No	1-24	25-49	50-99	100+	ROW
1 WATT	BNC	1,000	Aluminum	1.40:1	0 - 42	1	PE7038-1	\$618.21	\$574.94	\$531.66	\$494.57	62
					0 - 82.5	0.5	PE7038-2	\$606.16	\$563.73	\$521.30	\$484.93	
2 WATT	BNC	1,000	Aluminum	1.40:1	0 - 102	1	PE7038-3	\$644.81	\$599.67	\$554.54	\$515.85	

Attenuators

See Our Website For Real-Time Stock Availability!



Free Freight Available  
via UPS Ground  
to USA & Canada



Real-Time Stock  
Levels & Pricing  
On Our WebSite



Toll-Free Technical  
Support  
(866) 727-8376



Same-Day Shipping,  
Even Custom  
Cable Assemblies

# Programmable Attenuators

## 50 OHM



SMA

Max. Power	Connector	Max. Frequency (MHz.)	Construction Material	VSWR Max. (MHz)	Attenuation Range (dB)	Step Size (dB)	Model No	1-24	25-49	50-99	100+	ROW
0.5 WATT	SMA	1,000	Aluminum	1.40:1	0 - 63	1	PE7011-6A	\$730.59	\$679.45	\$628.31	\$584.47	63

# DC Bias Attenuators

## 50 OHM



SMA

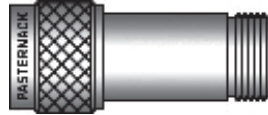

N

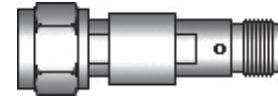

TNC

Max. Power	Connector	Frequency Range (MHz.)	Construction Material	VSWR Max. (MHz)	Max. V (V)	Max. I (Amp)	Attenuation (dB)	Model No	1-24	25-49	50-99	100+	ROW
2 WATT	SMA	500 - 2,000	Stainless Steel	1.35:1	100	2	6	PE7061-6	\$75.14	\$69.88	\$64.62	\$60.11	64
							10	PE7061-10	\$75.14	\$69.88	\$64.62	\$60.11	
							20	PE7061-20	\$76.76	\$71.39	\$66.01	\$61.41	
	N	500 - 2,000	Stainless Steel	1.35:1	100	2	6	PE7062-6	\$86.94	\$80.85	\$74.77	\$69.55	65
							10	PE7062-10	\$86.94	\$80.85	\$74.77	\$69.55	
							20	PE7062-20	\$91.25	\$84.86	\$78.48	\$73.00	
	TNC	500 - 2,000	Stainless Steel	1.35:1	100	2	6	PE7063-6	\$99.76	\$92.78	\$85.79	\$79.81	66
							10	PE7063-10	\$99.76	\$92.78	\$85.79	\$79.81	
							20	PE7063-20	\$102.95	\$95.74	\$88.54	\$82.36	

## 75 OHM



F

Max. Power	Connector	Frequency Range (MHz.)	Construction Material	VSWR Max. (MHz)	Max. V (V)	Max. I (Amp)	Attenuation (dB)	Model No	1-24	25-49	50-99	100+	ROW
2 WATT	F	500 - 2,000	Stainless Steel	1.45:1	100	2	6	PE7064-6	\$106.90	\$99.42	\$91.93	\$85.52	67
							10	PE7064-10	\$106.90	\$99.42	\$91.93	\$85.52	
	SMA	500 - 2,000	Stainless Steel	1.45:1	100	2	20	PE7064-20	\$106.90	\$99.42	\$91.93	\$85.52	

The 60 GHz frequency is an “unlicensed” band and does not require a transmitting license from the Federal Communications Commission (FCC).

Attenuators

See Our Website For Real-Time Stock Availability!

# Continuously Variable Attenuators

50 OHM

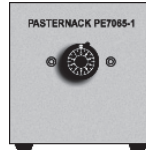

SMA

Max. Power	Connector	Freq. Range (MHz.)	Construction Material	VSWR Max.	Attenuation Range (dB)	Model No	1-24	25-49	50-99	100+	ROW
5 WATT	SMA	1,000 - 2,000	Aluminum	2.00:1	7	PE7065-1	\$459.23	\$427.08	\$394.94	\$367.38	68
					10	PE7065-2	\$459.23	\$427.08	\$394.94	\$367.38	
		2,000 - 4,000		1.80:1	20	PE7065-3	\$483.90	\$450.03	\$416.15	\$387.12	
					10	PE7065-4	\$463.08	\$430.66	\$398.25	\$370.46	
		4,000 - 8,000		1.50:1	20	PE7065-5	\$483.90	\$450.03	\$416.15	\$387.12	
					30	PE7065-6	\$546.78	\$508.51	\$470.23	\$437.42	
		8,000 - 12,400		1.70:1	10	PE7065-7	\$508.58	\$472.98	\$437.38	\$406.86	
					20	PE7065-8	\$561.98	\$522.64	\$483.30	\$449.58	
					30	PE7065-9	\$561.98	\$522.64	\$483.30	\$449.58	
					40	PE7065-10	\$561.98	\$522.64	\$483.30	\$449.58	
		12,400 - 18,000		1.50:1	10	PE7065-11	\$561.98	\$522.64	\$483.30	\$449.58	
					20	PE7065-12	\$561.98	\$522.64	\$483.30	\$449.58	
					30	PE7065-13	\$561.98	\$522.64	\$483.30	\$449.58	
					40	PE7065-14	\$587.71	\$546.57	\$505.43	\$470.17	

# TERMINATIONS

RF Load

50 OHM

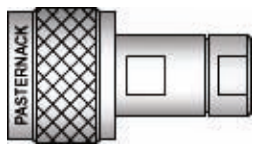

N Male

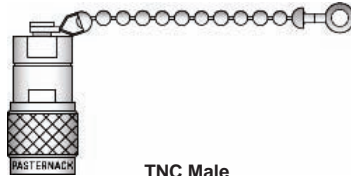

TNC Male



BNC Male

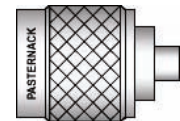

TNC Female

Max. Power	Connector	Max. Freq. (MHz.)	Construction Material	VSWR Max.	Chain	Model No	1-24	25-49	50-99	100+	ROW
0.5 WATT	SMA Male	12,400	Stainless Steel	1.17:1	No	PE6002	\$40.03	\$37.23	\$34.43	\$32.02	1
					Yes	PE6069	\$43.17	\$40.15	\$37.13	\$34.54	2
	SMA Female	40,000	1.20:1	No	PE6003	\$36.28	\$33.74	\$31.20	\$29.02	3	
					Yes	PE6070	\$42.25	\$39.29	\$36.34	\$33.80	4
	2.92mm Male	1,000	Brass	No	PE6085	\$307.94	\$286.38	\$264.83	\$246.35	5	
					Yes	PE6086	\$312.50	\$290.63	\$268.75	\$250.00	6
	2.92mm Female	1,000	Yes	No	PE6088	\$329.68	\$306.60	\$283.52	\$263.74	7	
					Yes	PE6001-50	\$18.09	\$16.82	\$15.56	\$14.47	8
	N Male	1,000	Brass	No	PE6062-50	\$21.48	\$19.98	\$18.47	\$17.18	9	
					Yes	PE6028-50	\$19.05	\$17.72	\$16.38	\$15.24	10
	N Female	1,000	Yes	No	PE6065-50	\$25.08	\$23.32	\$21.57	\$20.06	11	
					Yes	PE6011-50	\$17.88	\$16.63	\$15.38	\$14.30	12
	TNC Male	1,000	Yes	No	PE6063-50	\$23.86	\$22.19	\$20.52	\$19.09	13	
					Yes	PE6029-50	\$20.72	\$19.27	\$17.82	\$16.58	14
	TNC Female	1,000	Yes	No	PE6066-50	\$25.08	\$23.32	\$21.57	\$20.06	15	
					Yes	PE6146	\$67.54	\$62.81	\$58.08	\$54.03	16
	7/16 DIN Male	40,000	Stainless Steel	1.35:1	No	PE6049	\$21.48	\$19.98	\$18.47	\$17.18	17
					Yes	PE6050	\$21.48	\$19.98	\$18.47	\$17.18	18
	SMC Plug	1,000	Brass	No	PE6163	\$176.57	\$164.21	\$151.85	\$141.26	19	
					Yes	PE6162	\$176.57	\$164.21	\$151.85	\$141.26	20
	SMC Jack	1,000	No	No	PE6044	\$21.48	\$19.98	\$18.47	\$17.18	21	
					Yes	PE6045	\$27.51	\$25.58	\$23.66	\$22.01	22
	MINI SMP Male	1,000	Yes	No	PE6000-50	\$17.28	\$16.07	\$14.86	\$13.82	23	
					Yes	PE6061-50	\$20.32	\$18.90	\$17.48	\$16.26	24
	MINI SMP Female	1,000	No	No	PE6027-50	\$17.88	\$16.63	\$15.38	\$14.30	25	
					Yes	PE6064-50	\$23.86	\$22.19	\$20.52	\$19.09	26
	SMB Plug	1,000	Yes	No	PE6145	\$38.25	\$35.57	\$32.90	\$30.60	27	
					Yes	PE6147	\$41.80	\$38.87	\$35.95	\$33.44	28
SMB Jack	1,000	No	No	PE6145	\$38.25	\$35.57	\$32.90	\$30.60	27		
				Yes	PE6147	\$41.80	\$38.87	\$35.95	\$33.44	28	
BNC Male	1,000	Brass	No	PE6000-50	\$17.28	\$16.07	\$14.86	\$13.82	23		
				Yes	PE6061-50	\$20.32	\$18.90	\$17.48	\$16.26	24	
BNC Female	1,000	No	No	PE6027-50	\$17.88	\$16.63	\$15.38	\$14.30	25		
				Yes	PE6064-50	\$23.86	\$22.19	\$20.52	\$19.09	26	
C Male	1,000	Yes	No	PE6145	\$38.25	\$35.57	\$32.90	\$30.60	27		
				Yes	PE6147	\$41.80	\$38.87	\$35.95	\$33.44	28	

Terminations & Matching Pads

See Our Website For Real-Time Stock Availability!

Free Freight Available via UPS Ground to USA & Canada



Real-Time Stock Levels & Pricing On Our WebSite



Toll-Free Technical Support (866) 727-8376



Same-Day Shipping, Even Custom Cable Assemblies

# RF Load

## 50 OHM

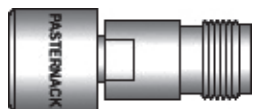

TNC Female

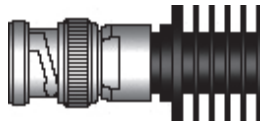

BNC Male

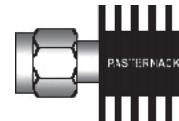

SMA Male

Max. Power	Connector	Max. Freq. (MHz.)	Construction Material	VSWR Max.	Chain	Model No	1-24	25-49	50-99	100+	Row				
1 WATT	SMA Male	1,000	Brass	1.05:1	No	PE6148	\$18.09	\$16.82	\$15.56	\$14.47	1				
		2,500		1.10:1	No	PE6149	\$21.61	\$20.10	\$18.58	\$17.29	2				
		4,000		1.10:1	No	PE6150	\$23.41	\$21.77	\$20.13	\$18.73	3				
		8,000	Stainless Steel	1.15:1	No	PE6151	\$26.80	\$24.92	\$23.05	\$21.44	4				
		18,000		1.20:1	No	PE6071	\$45.04	\$41.89	\$38.73	\$36.03	5				
		26,500		Yes	PE6072	\$53.00	\$49.29	\$45.58	\$42.40	6					
				1.25:1	No	PE6077	\$77.42	\$72.00	\$66.58	\$61.94	7				
	SMA Female	18,000	Stainless Steel	1.35:1	Yes	PE6078	\$78.68	\$73.17	\$67.66	\$62.94	8				
				1.20:1	No	PE6073	\$52.18	\$48.53	\$44.87	\$41.74	9				
				Yes	PE6074	\$64.09	\$59.60	\$55.12	\$51.27	10					
		26,500		No	PE6079	\$78.68	\$73.17	\$67.66	\$62.94	11					
		Yes		PE6080	\$86.13	\$80.10	\$74.07	\$68.90	12						
		40,000		1.25:1	No	PE6173	\$182.29	\$169.53	\$156.77	\$145.83	13				
	Yes	PE6174	\$192.43		\$178.96	\$165.49	\$153.94	14							
	No	PE6175	\$192.43		\$178.96	\$165.49	\$153.94	15							
	2.92mm Male	50,000	1.45:1	No	PE6178	\$455.99	\$424.07	\$392.15	\$364.79	16					
				Yes	PE6179	\$363.77	\$338.31	\$312.84	\$291.02	17					
2.92mm Female	12,400	Brass	1.30:1	No	PE6180	\$353.64	\$328.89	\$304.13	\$282.91	18					
2.4mm Male				No	PE6164	\$18.44	\$17.15	\$15.86	\$14.75	19					
2.4mm Female	10,000	1.25:1	No	PE6161	\$147.08	\$136.78	\$126.49	\$117.66	20						
QMA Male	18,000			No	PE6160	\$148.14	\$137.77	\$127.40	\$118.51	21					
SMP Male	18,000	Stainless Steel	1.20:1	No	PE6081	\$47.57	\$44.24	\$40.91	\$38.06	22					
SMP Female				Yes	PE6082	\$55.28	\$51.41	\$47.54	\$44.22	23					
2 WATT	SMA Male	18,000	Stainless Steel	No	PE6083	\$48.33	\$44.95	\$41.56	\$38.66	24					
				Yes	PE6084	\$58.87	\$54.75	\$50.63	\$47.10	25					
	SMA Female	40,000	1.25:1	No	PE6176	\$258.39	\$240.30	\$222.22	\$206.71	26					
				Yes	PE6177	\$268.52	\$249.72	\$230.93	\$214.82	27					
	N Male	1,000	Brass	1.05:1	No	PE6152	\$20.32	\$18.90	\$17.48	\$16.26	28				
					2,000	No	PE6153	\$22.60	\$21.02	\$19.44	\$18.08	29			
					4,000	No	PE6154	\$25.38	\$23.60	\$21.83	\$20.30	30			
					18,000	No	PE6009	\$43.22	\$40.19	\$37.17	\$34.58	31			
	Yes	PE6075	\$49.65	\$46.17		\$42.70	\$39.72	32							
	N Female	18,000	1.30:1	No	PE6032	\$56.80	\$52.82	\$48.85	\$45.44	33					
				Yes	PE6076	\$76.40	\$71.05	\$65.70	\$61.12	34					
	TNC Male	2,000	1.15:1	No	PE6157	\$20.52	\$19.08	\$17.65	\$16.42	35					
				4,000	No	PE6158	\$22.95	\$21.34	\$19.74	\$18.36	36				
	TNC Female	18,000	Stainless Steel	1.25:1	No	PE6089	\$98.54	\$91.64	\$84.74	\$78.83	37				
					Yes	PE6090	\$103.05	\$95.84	\$88.62	\$82.44	38				
					No	PE6091	\$91.05	\$84.68	\$78.30	\$72.84	39				
		Yes		PE6092	\$97.07	\$90.28	\$83.48	\$77.66	40						
BNC Male		1,000		Brass	1.10:1	No	PE6155	\$19.20	\$17.86	\$16.51	\$15.36	41			
						4,000	No	PE6156	\$20.32	\$18.90	\$17.48	\$16.26	42		
5 WATT	SMA Male	18,000	Stainless Steel	1.25:1	No	PE6095	\$93.73	\$87.17	\$80.61	\$74.98	43				
					No	PE6096	\$123.52	\$114.87	\$106.23	\$98.82	44				
	No				PE6097	\$89.53	\$83.26	\$77.00	\$71.62	45					
	No				PE6098	\$91.05	\$84.68	\$78.30	\$72.84	46					
	No				PE6099	\$115.67	\$107.57	\$99.48	\$92.54	47					
	No				PE6138	\$117.64	\$109.41	\$101.17	\$94.11	48					
	7/16 DIN Male				7,000	Brass	1.40:1	No	PE6100	\$117.64	\$109.41	\$101.17	\$94.11	49	
	7/16 DIN Female							No	PE6139	\$117.64	\$109.41	\$101.17	\$94.11	50	
	10 WATT				SMA Male	18,000	Aluminum Heatsink	1.25:1	No	PE6036	\$172.21	\$160.16	\$148.10	\$137.77	51
									No	PE6103	\$168.51	\$156.71	\$144.92	\$134.81	52
SMA Female		1.40:1	No	PE6035	\$196.48			\$182.73	\$168.97	\$157.18	53				
			No	PE6102	\$201.75			\$187.63	\$173.51	\$161.40	54				
N Male		1.25:1	No	PE6104	\$211.68			\$196.86	\$182.04	\$169.34	55				
N Female			No	PE6140	\$215.28			\$200.21	\$185.14	\$172.22	56				
TNC Male		7,000	1.40:1	No	PE6105			\$233.77	\$217.41	\$201.04	\$187.02	57			
TNC Female				No	PE6141			\$233.77	\$217.41	\$201.04	\$187.02	58			
7/16 DIN Male	4,000	1.25:1	No	PE6034	\$128.18	\$119.21	\$110.23	\$102.54	59						
7/16 DIN Female			No	PE6101	\$163.14	\$151.72	\$140.30	\$130.51	60						
25 WATT	SMA Female	18,000	Aluminum Heatsink	1.40:1	No	PE6038	\$347.31	\$323.00	\$298.69	\$277.85	61				
					No	PE6106	\$312.50	\$290.63	\$268.75	\$250.00	62				
	N Male			1.25:1	No	PE6037	\$412.06	\$383.22	\$354.37	\$329.65	63				
					No	PE6107	\$353.24	\$328.51	\$303.79	\$282.59	64				

Terminations & Matching Pads

See Our Website For Real-Time Stock Availability!

# RF Load

## 50 OHM

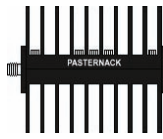

SMA Female



N Female



7/16 DIN Female

Max. Power	Connector	Max. Freq. (MHz.)	Construction Material	VSWR Max.	Chain	Model No	1-24	25-49	50-99	100+	ROW
50 WATT	SMA Female	18,000	Aluminum Heatsink	1.45:1	No	PE6040	\$436.38	\$405.83	\$375.29	\$349.10	1
	N Male	4,000		1.25:1	No	PE6167	\$376.39	\$350.04	\$323.70	\$301.11	2
	N Female	18,000		1.45:1	No	PE6039	\$429.39	\$399.33	\$369.28	\$343.51	3
	7/16 DIN Female	7,000		1.35:1	No	PE6112	\$441.70	\$410.78	\$379.86	\$353.36	4
100 WATT	SMA Male	4,000	Aluminum Heatsink	1.25:1	No	PE6166	\$376.39	\$350.04	\$323.70	\$301.11	5
	SMA Female	2,000		1.30:1	No	PE6043	\$694.67	\$646.04	\$597.42	\$555.74	6
	N Male	4,000		1.25:1	No	PE6168	\$672.22	\$625.16	\$578.11	\$537.78	7
	N Female	2,000			No	PE6042	\$675.82	\$628.51	\$581.21	\$540.66	8
	7/16 DIN Male	4,000			No	PE6169	\$403.29	\$375.06	\$346.83	\$322.63	9
	7/16 DIN Female	2,000		1.35:1	No	PE6137	\$714.83	\$664.79	\$614.75	\$571.86	10
	BNC Female			1.25:1	No	PE6041	\$649.63	\$604.16	\$558.68	\$519.70	11

## 75 OHM

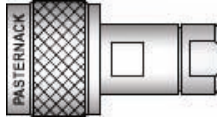

N Male

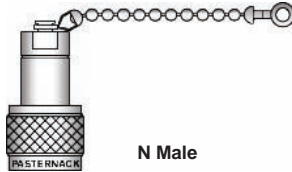

N Male



N Female

Max. Power	Connector	Max. Freq. (MHz.)	Construction Material	VSWR Max.	Chain	Model No	1-24	25-49	50-99	100+	ROW
0.25 WATT	BNC Male	3,000	Brass	1.25:1	No	PE6165	\$17.78	\$16.54	\$15.29	\$14.22	12
0.5 WATT	N Male	1,000	Brass	1.25:1	No	PE6047	\$21.48	\$19.98	\$18.47	\$17.18	13
					Yes	PE6067	\$27.51	\$25.58	\$23.66	\$22.01	14
	N Female				No	PE6048	\$28.02	\$26.06	\$24.10	\$22.42	15
					Yes	PE6068	\$31.06	\$28.89	\$26.71	\$24.85	16
	TNC Male				No	PE6011-75	\$17.88	\$16.63	\$15.38	\$14.30	17
	SMC Plug				Yes	PE6063-75	\$23.86	\$22.19	\$20.52	\$19.09	18
					No	PE6055	\$27.51	\$25.58	\$23.66	\$22.01	19
	SMC Jack				No	PE6056	\$34.60	\$32.18	\$29.76	\$27.68	20
	SMB Plug				No	PE6053	\$27.51	\$25.58	\$23.66	\$22.01	21
					No	PE6054	\$34.60	\$32.18	\$29.76	\$27.68	22
	SMB Jack				No	PE6159	\$25.08	\$23.32	\$21.57	\$20.06	23
	MINI SMB Male				No	PE6051	\$23.15	\$21.53	\$19.91	\$18.52	24
	BNC Male				Yes	PE6093	\$30.75	\$28.60	\$26.45	\$24.60	25
					No	PE6052	\$21.48	\$19.98	\$18.47	\$17.18	26
BNC Female	Yes	PE6094	\$27.51	\$25.58	\$23.66	\$22.01	27				

## 93 OHM

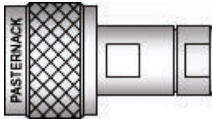

N Male

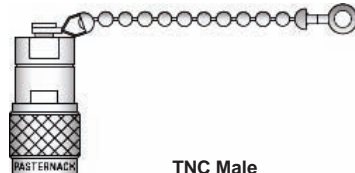

TNC Male

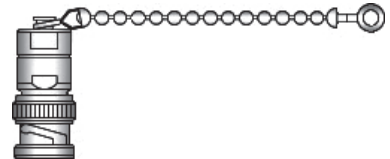

BNC Male

Max. Power	Connector	Max. Freq. (MHz.)	Construction Material	VSWR Max.	Chain	Model No	1-24	25-49	50-99	100+	ROW
0.5 WATT	N Male	1,000	Brass	1.25:1	No	PE6001-93	\$18.09	\$16.82	\$15.56	\$14.47	28
					Yes	PE6062-93	\$21.48	\$19.98	\$18.47	\$17.18	29
	TNC Male				No	PE6011-93	\$17.88	\$16.63	\$15.38	\$14.30	30
					Yes	PE6063-93	\$23.86	\$22.19	\$20.52	\$19.09	31
BNC Male	No	PE6000-93	\$17.28	\$16.07	\$14.86	\$13.82	32				

Terminations & Matching Pads

See Our Website For Real-Time Stock Availability!





## RF Load

**93 OHM**

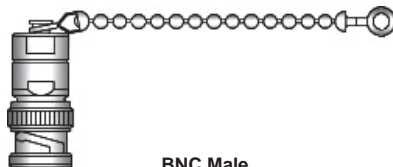

BNC Male

Max. Power	Connector	Max. Freq. (MHz.)	Construction Material	VSWR Max.	Chain	Model No	1-24	25-49	50-99	100+	ROW
0.5 WATT	BNC Male	1,000	Brass		Yes	PE6061-93	\$20.32	\$18.90	\$17.48	\$16.26	1

## Feed-Thru Load

**50 OHM**

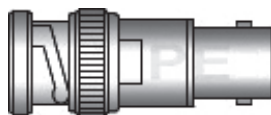

BNC Male



SMA Male



N Male

Max. Power	Connector	Max. Freq. (MHz.)	Construction Material	VSWR Max.	Chain	Model No	1-24	25-49	50-99	100+	ROW
1 WATT	TNC Male	1,000	Brass		No	PE6142-50	\$41.80	\$38.87	\$35.95	\$33.44	2
	BNC Male				No	PE6008-50	\$31.06	\$28.89	\$26.71	\$24.85	3
2 WATT	SMA Male	1,000	Stainless Steel		No	PE6026	\$65.41	\$60.83	\$56.25	\$52.33	4
	N Male		Brass		No	PE6033	\$76.40	\$71.05	\$65.70	\$61.12	5

**75 OHM**

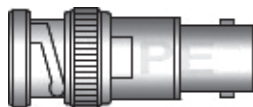

BNC Male

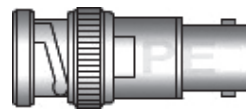

BNC Male

Max. Power	Connector	Max. Freq. (MHz.)	Construction Material	VSWR Max.	Chain	Model No	1-24	25-49	50-99	100+	ROW
1 WATT	TNC Male	1,000	Brass		No	PE6142-75	\$41.80	\$38.87	\$35.95	\$33.44	6
	BNC Male				No	PE6008-75	\$31.06	\$28.89	\$26.71	\$24.85	7

## MATCHING PADS

### Resistive Impedance Transformers



N Female

Model No	Connector B 50 Ω	Connector B 75 Ω	Max. Frequency (MHz.)	VSWR Max.	Attenuation Loss (dB)	Accuracy (dB)	1-24	25-49	50-99	100+	ROW
PE7027	N Male	N Female	500	1.20:1	5.7	± .5	\$78.63	\$73.13	\$67.62	\$62.90	8

Terminations & Matching Pads

See Our Website For Real-Time Stock Availability!

# Resistive Impedance Transformers



N Female

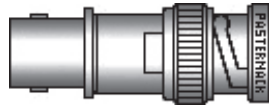

BNC Male

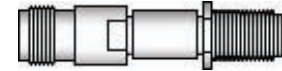

TNC Female

Model No	Connector B 50 Ω	Connector B 75 Ω	Max. Frequency (MHz.)	VSWR Max.	Attenuation Loss (dB)	Accuracy (dB)	1-24	25-49	50-99	100+	ROW
PE7028	N Female	N Male	1,000	1.20:1	5.7	± .5	\$78.63	\$73.13	\$67.62	\$62.90	1
PE7006	BNC Male	BNC Female	1,000	1.20:1	5.7	± .5	\$40.38	\$37.55	\$34.73	\$32.30	2
PE7007	BNC Female	BNC Male	1,000	1.20:1	5.7	± .5	\$40.38	\$37.55	\$34.73	\$32.30	3
PE7075	SMA Male	F Male	3,000	1.25:1	5.7	± .5	\$82.33	\$76.57	\$70.80	\$65.86	4
PE7076	SMA Male	F Female	3,000	1.25:1	5.7	± .5	\$80.96	\$75.29	\$69.63	\$64.77	5
PE7077	SMA Female	F Male	3,000	1.25:1	5.7	± .5	\$80.20	\$74.59	\$68.97	\$64.16	6
PE7078	SMA Female	F Female	3,000	1.25:1	5.7	± .5	\$80.96	\$75.29	\$69.63	\$64.77	7
PE7070	N Male	N Female	3,000	1.35:1	5.7	± .5	\$80.96	\$75.29	\$69.63	\$64.77	8
PE7072	N Male	F Male	3,000	1.25:1	5.7	± .5	\$82.33	\$76.57	\$70.80	\$65.86	9
PE7071	N Male	F Female	3,000	1.25:1	5.7	± .5	\$80.20	\$74.59	\$68.97	\$64.16	10
PE7083	N Female	N Male	3,000	1.35:1	5.7	± .5	\$86.23	\$80.19	\$74.16	\$68.98	11
PE7073	N Female	F Male	3,000	1.25:1	5.7	± .5	\$80.20	\$74.59	\$68.97	\$64.16	12
PE7074	N Female	F Female	3,000	1.25:1	5.7	± .5	\$80.96	\$75.29	\$69.63	\$64.77	13
PE7080	TNC Male	F Male	3,000	1.25:1	5.7	± .5	\$88.16	\$81.99	\$75.82	\$70.53	14
PE7079	TNC Male	F Female	3,000	1.25:1	5.7	± .5	\$88.16	\$81.99	\$75.82	\$70.53	15
PE7081	TNC Female	F Male	3,000	1.25:1	5.7	± .5	\$88.16	\$81.99	\$75.82	\$70.53	16
PE7082	TNC Female	F Female	3,000	1.25:1	5.7	± .5	\$88.16	\$81.99	\$75.82	\$70.53	17
PE7067	BNC Male	F Male	3,000	1.25:1	5.7	± .5	\$82.33	\$76.57	\$70.80	\$65.86	18
PE7066	BNC Male	F Female	3,000	1.25:1	5.7	± .5	\$80.96	\$75.29	\$69.63	\$64.77	19
PE7068	BNC Female	F Male	3,000	1.25:1	5.7	± .5	\$84.61	\$78.69	\$72.76	\$67.69	20
PE7069	BNC Female	F Female	3,000	1.25:1	5.7	± .5	\$82.33	\$76.57	\$70.80	\$65.86	21

See Our Website For Real-Time Stock Availability!

Couplers and Dividers

## COUPLERS

### Single Directional

#### SMA Connectors



Frequency Range (MHz.)	Coupling (dB)	Maximum Power	Directivity (dB)	Model No	1-24	25-49	50-99	100+	ROW
500 - 1,000	6	50 Watt	25	PE2200-6	\$280.99	\$261.32	\$241.65	\$224.79	22
	10			PE2200-10	\$280.99	\$261.32	\$241.65	\$224.79	
	20			PE2200-20	\$280.99	\$261.32	\$241.65	\$224.79	
	30			PE2200-30	\$280.99	\$261.32	\$241.65	\$224.79	
500 - 2,000	6	50 Watt	23	PE2208-6	\$370.87	\$344.91	\$318.95	\$296.70	23
	10			PE2208-10	\$370.87	\$344.91	\$318.95	\$296.70	
	20			PE2208-20	\$370.87	\$344.91	\$318.95	\$296.70	
600 - 4,000	10	50 Watt	18	PE2213-10	\$561.98	\$522.64	\$483.30	\$449.58	24
800 - 2,500	6	50 Watt	20	PE2238-6	\$322.63	\$300.05	\$277.46	\$258.10	25
	10			PE2238-10	\$322.63	\$300.05	\$277.46	\$258.10	
	20			PE2238-20	\$322.63	\$300.05	\$277.46	\$258.10	
	30			PE2238-30	\$322.63	\$300.05	\$277.46	\$258.10	



Free Freight Available  
via UPS Ground  
to USA & Canada



Real-Time Stock  
Levels & Pricing  
On Our WebSite



Toil-Free Technical  
Support  
(866) 727-8376



Same-Day Shipping,  
Even Custom  
Cable Assemblies

# Single Directional

## SMA Connectors

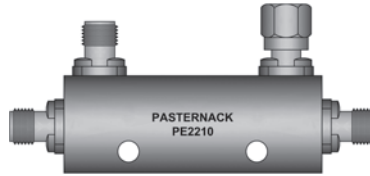

Frequency Range (MHz.)	Coupling (dB)	Maximum Power	Directivity (dB)	Model No	1-24	25-49	50-99	100+	ROW
1,000 - 2,000	6	50 Watt	25	PE2201-6	\$280.99	\$261.32	\$241.65	\$224.79	1
	10			PE2201-10	\$280.99	\$261.32	\$241.65	\$224.79	
	20			PE2201-20	\$280.99	\$261.32	\$241.65	\$224.79	
	30			PE2201-30	\$280.99	\$261.32	\$241.65	\$224.79	
1,000 - 4,000	6	50 Watt	23	PE2209-6	\$370.87	\$344.91	\$318.95	\$296.70	2
	10			PE2209-10	\$370.87	\$344.91	\$318.95	\$296.70	
	20			PE2209-20	\$382.01	\$355.27	\$328.53	\$305.61	
1,000 - 18,000	10	25 Watt	15	PE2214-10	\$1,348.85	\$1,254.43	\$1,160.01	\$1,079.08	3
	16			PE2214-16	\$1,348.85	\$1,254.43	\$1,160.01	\$1,079.08	
	20			PE2214-20	\$1,348.85	\$1,254.43	\$1,160.01	\$1,079.08	
2,000 - 4,000	6	50 Watt	22	PE2202-6	\$280.99	\$261.32	\$241.65	\$224.79	4
	10			PE2202-10	\$280.99	\$261.32	\$241.65	\$224.79	
	20			PE2202-20	\$280.99	\$261.32	\$241.65	\$224.79	
	30			PE2202-30	\$280.99	\$261.32	\$241.65	\$224.79	
2,000 - 8,000	6	50 Watt	20	PE2210-6	\$385.05	\$358.10	\$331.14	\$308.04	5
	10			PE2210-10	\$370.87	\$344.91	\$318.95	\$296.70	
	20			PE2210-20	\$370.87	\$344.91	\$318.95	\$296.70	
2,000 - 18,000	6	25 Watt	15	PE2215-6	\$1,348.85	\$1,254.43	\$1,160.01	\$1,079.08	6
	10			PE2215-10	\$1,348.85	\$1,254.43	\$1,160.01	\$1,079.08	
	16			PE2215-16	\$1,348.85	\$1,254.43	\$1,160.01	\$1,079.08	
	20			PE2215-20	\$1,348.85	\$1,254.43	\$1,160.01	\$1,079.08	
2,600 - 5,200	6	50 Watt	20	PE2203-6	\$280.99	\$261.32	\$241.65	\$224.79	7
	10			PE2203-10	\$280.99	\$261.32	\$241.65	\$224.79	
	20			PE2203-20	\$280.99	\$261.32	\$241.65	\$224.79	
	30			PE2203-30	\$280.99	\$261.32	\$241.65	\$224.79	
4,000 - 8,000	6	50 Watt	20	PE2204-6	\$293.86	\$273.29	\$252.72	\$235.09	8
	10			PE2204-10	\$280.99	\$261.32	\$241.65	\$224.79	
	20			PE2204-20	\$280.99	\$261.32	\$241.65	\$224.79	
	30			PE2204-30	\$280.99	\$261.32	\$241.65	\$224.79	
4,000 - 12,400	6	50 Watt	17	PE2211-6	\$370.87	\$344.91	\$318.95	\$296.70	9
	10			PE2211-10	\$370.87	\$344.91	\$318.95	\$296.70	
	20			PE2211-20	\$370.87	\$344.91	\$318.95	\$296.70	
4,000 - 18,000	6	50 Watt	15	PE2216-6	\$561.98	\$522.64	\$483.30	\$449.58	10
	10			PE2216-10	\$561.98	\$522.64	\$483.30	\$449.58	
	20			PE2216-20	\$561.98	\$522.64	\$483.30	\$449.58	
7,000 - 12,400	6	50 Watt	17	PE2205-6	\$349.59	\$325.12	\$300.65	\$279.67	11
	10			PE2205-10	\$349.59	\$325.12	\$300.65	\$279.67	
	20			PE2205-20	\$349.59	\$325.12	\$300.65	\$279.67	
	30			PE2205-30	\$349.59	\$325.12	\$300.65	\$279.67	
7,000 - 18,000	10	50 Watt	15	PE2212-10	\$392.91	\$365.41	\$337.90	\$314.33	12
	10		12	PE2206-10	\$349.59	\$325.12	\$300.65	\$279.67	
7,500 - 16,000	20	50 Watt	15	PE2206-20	\$349.59	\$325.12	\$300.65	\$279.67	13
	30			PE2206-30	\$349.59	\$325.12	\$300.65	\$279.67	
	30			PE2207-6	\$360.08	\$334.87	\$309.67	\$288.06	
12,400 - 18,000	10	50 Watt	15	PE2207-10	\$360.08	\$334.87	\$309.67	\$288.06	14
	20			PE2207-20	\$360.08	\$334.87	\$309.67	\$288.06	
	20			PE2207-20	\$360.08	\$334.87	\$309.67	\$288.06	
	30			PE2207-30	\$360.08	\$334.87	\$309.67	\$288.06	

## N Connectors



Frequency Range (MHz.)	Coupling (dB)	Maximum Power	Directivity (dB)	Model No	1-24	25-49	50-99	100+	ROW
800 - 2,500	6	70 Watt	20	PE2237-6	\$322.63	\$300.05	\$277.46	\$258.10	15
	10			PE2237-10	\$322.63	\$300.05	\$277.46	\$258.10	
	20			PE2237-20	\$322.63	\$300.05	\$277.46	\$258.10	
	30			PE2237-30	\$322.63	\$300.05	\$277.46	\$258.10	
1,000 - 2,000	30	600 Watt	5	PE2226-30	\$999.87	\$929.88	\$859.89	\$799.90	16

See Our Website For Real-Time Stock Availability!

Couplers and Dividers

# Single Directional

## N Connectors



Frequency Range (MHz.)	Coupling (dB)	Maximum Power	Directivity (dB)	Model No	1-24	25-49	50-99	100+	ROW
1,000 - 4,000	30	600 Watt	15	PE2228-30	\$1,396.99	\$1,299.20	\$1,201.41	\$1,117.59	1
1,000 - 8,000	30	50 Watt	15	PE2239-30	\$1,513.01	\$1,407.10	\$1,301.19	\$1,210.41	2
1,000 - 11,000	35	600 Watt	15	PE2236-35	\$1,910.93	\$1,777.16	\$1,643.40	\$1,528.74	3
1,500 - 4,500	30	600 Watt	18	PE2231-30	\$1,272.00	\$1,182.96	\$1,093.92	\$1,017.60	4
2,000 - 4,000	30	600 Watt	18	PE2227-30	\$1,123.04	\$1,044.43	\$965.81	\$898.43	5
2,000 - 8,000	30	600 Watt	16	PE2232-30	\$1,512.45	\$1,406.58	\$1,300.71	\$1,209.96	6
2,600 - 5,200	30	600 Watt	18	PE2229-30	\$946.62	\$880.36	\$814.09	\$757.30	7
4,000 - 8,000	30	600 Watt	18	PE2230-30	\$996.88	\$927.10	\$857.32	\$797.50	8
4,000 - 12,000	30	600 Watt	15	PE2235-30	\$1,272.00	\$1,182.96	\$1,093.92	\$1,017.60	9
5,000 - 11,000	30	600 Watt	15	PE2234-30	\$786.88	\$731.80	\$676.72	\$629.50	10
7,000 - 11,000	30	600 Watt	16	PE2233-30	\$946.62	\$880.36	\$814.09	\$757.30	11

# Dual Directional

## SMA Connectors

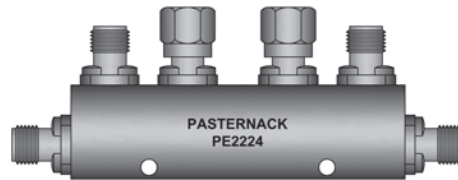

Frequency Range (MHz.)	Coupling (dB)	Maximum Power	Directivity (dB)	Model No	1-24	25-49	50-99	100+	ROW
500 - 1,000	10	10 Watt	22	PE2217-10	\$561.98	\$522.64	\$483.30	\$449.58	12
	20			PE2217-20	\$561.98	\$522.64	\$483.30	\$449.58	
	30			PE2217-30	\$561.98	\$522.64	\$483.30	\$449.58	
1,000 - 2,000	10	10 Watt	22	PE2218-10	\$561.98	\$522.64	\$483.30	\$449.58	13
	20			PE2218-20	\$561.98	\$522.64	\$483.30	\$449.58	
	30			PE2218-30	\$561.98	\$522.64	\$483.30	\$449.58	
2,000 - 4,000	10	10 Watt	20	PE2219-10	\$561.98	\$522.64	\$483.30	\$449.58	14
	20			PE2219-20	\$561.98	\$522.64	\$483.30	\$449.58	
	30			PE2219-30	\$561.98	\$522.64	\$483.30	\$449.58	
2,600 - 5,200	10	10 Watt	18	PE2220-10	\$561.98	\$522.64	\$483.30	\$449.58	14
	20			PE2220-20	\$561.98	\$522.64	\$483.30	\$449.58	
	30			PE2220-30	\$561.98	\$522.64	\$483.30	\$449.58	
4,000 - 8,000	10	10 Watt	18	PE2221-10	\$561.98	\$522.64	\$483.30	\$449.58	16
	20			PE2221-20	\$561.98	\$522.64	\$483.30	\$449.58	
	30			PE2221-30	\$561.98	\$522.64	\$483.30	\$449.58	
7,000 - 12,400	10	10 Watt	16	PE2222-10	\$561.98	\$522.64	\$483.30	\$449.58	17
	20			PE2222-20	\$561.98	\$522.64	\$483.30	\$449.58	
	30			PE2222-30	\$561.98	\$522.64	\$483.30	\$449.58	
8,000 - 16,000	10	10 Watt	15	PE2223-10	\$561.98	\$522.64	\$483.30	\$449.58	18
	20			PE2223-20	\$561.98	\$522.64	\$483.30	\$449.58	
	30			PE2223-30	\$561.98	\$522.64	\$483.30	\$449.58	
12,400 - 18,000	20	10 Watt	15	PE2224-20	\$561.98	\$522.64	\$483.30	\$449.58	19
	30			PE2224-30	\$561.98	\$522.64	\$483.30	\$449.58	

Couplers and Dividers

The C connector was invented by engineer Carl Concelman and is weatherproof.



# Hybrids

## SMA Connectors



Frequency Range (MHz.)	Coupling (dB)	Maximum Power	Directivity (dB)	Model No	1-24	25-49	50-99	100+	ROW
500 -1,000	3.1	50 Watt		PE2050	\$325.88	\$303.07	\$280.26	\$260.70	1
1,000 - 2,000	3.1	50 Watt		PE2051	\$341.38	\$317.48	\$293.59	\$273.10	2
2,000 - 4,000	3.1	50 Watt		PE2052	\$359.67	\$334.49	\$309.32	\$287.74	3
2,000 - 18,000	3.3	30 Watt		PE2058	\$408.66	\$380.05	\$351.45	\$326.93	4
2,600 - 5,200	3.1	50 Watt		PE2053	\$393.41	\$365.87	\$338.33	\$314.73	5
4,000 - 8,000	3.2	50 Watt		PE2054	\$393.41	\$365.87	\$338.33	\$314.73	6
4,000 - 12,400	3.3	20 Watt		PE2059	\$467.89	\$435.14	\$402.39	\$374.31	7
6,000 - 12,400	3.2	50 Watt		PE2055	\$427.06	\$397.17	\$367.27	\$341.65	8
7,000 - 18,000	3.5	20 Watt		PE2060	\$505.79	\$470.38	\$434.98	\$404.63	9
7,500 - 16,000	3.4	40 Watt		PE2056	\$427.06	\$397.17	\$367.27	\$341.65	10
12,000 - 18,000	3.4	40 Watt		PE2057	\$370.87	\$344.91	\$318.95	\$296.70	11

# POWER DIVIDERS

## 50 OHM

### Resistive



Ports	Freq. Range (MHz.)	Connector	Gender	Maximum Power	Model No	1-24	25-49	50-99	100+	ROW
2 WAY	0 - 6,000	SMA	Female	1 Watt	PE2069	\$268.88	\$250.06	\$231.24	\$215.10	12
	0 - 12,400	2.92mm			PE2067	\$337.18	\$313.58	\$289.97	\$269.74	13
		SMA			PE2063	\$303.43	\$282.19	\$260.95	\$242.74	14
	0 - 18,000	2.92mm			PE2068	\$359.67	\$334.49	\$309.32	\$287.74	15
		N			PE2064	\$393.41	\$365.87	\$338.33	\$314.73	16
	0 - 26,500	2.92mm			PE2066	\$393.41	\$365.87	\$338.33	\$314.73	17
					PE2065	\$561.98	\$522.64	\$483.30	\$449.58	18

### Reactive



Ports	Freq. Range (MHz.)	Connector	Gender	Maximum Power	Model No	1-24	25-49	50-99	100+	ROW
2 WAY	2 - 500	N	Female	1 Watt	PE2044	\$303.18	\$281.96	\$260.73	\$242.54	19
		BNC			PE2000	\$143.03	\$133.02	\$123.01	\$114.42	20
		PE2003			\$168.56	\$156.76	\$144.96	\$134.85	21	
	500 - 1,000	SMA		PE2008	\$280.99	\$261.32	\$241.65	\$224.79	22	
		N		PE2032	\$449.60	\$418.13	\$386.66	\$359.68	23	
	800 - 2,500	SMA		PE2074	\$268.83	\$250.01	\$231.19	\$215.06	24	
		N		PE2071	\$215.12	\$200.06	\$185.00	\$172.10	25	
	1,000 - 2,000	SMA		PE2011	\$249.32	\$231.87	\$214.42	\$199.46	26	
		N		PE2033	\$449.60	\$418.13	\$386.66	\$359.68	27	



# 50 OHM

Reactive



Ports	Freq. Range (MHz.)	Connector	Gender	Maximum Power	Model No	1-24	25-49	50-99	100+	ROW			
2 WAY	2,000 - 4,000	SMA	Female	10 Watt	PE2014	\$225.21	\$209.45	\$193.68	\$180.17	1			
		N			PE2040	\$720.10	\$669.69	\$619.29	\$576.08	2			
	2,000 - 8,000	SMA			PE2026	\$354.35	\$329.55	\$304.74	\$283.48	3			
					PE2028	\$449.60	\$418.13	\$386.66	\$359.68	4			
	2,000 - 18,000	SMA			PE2017	\$293.86	\$273.29	\$252.72	\$235.09	5			
					PE2035	\$505.79	\$470.38	\$434.98	\$404.63	6			
	2,000 - 8,000	N			PE2020	\$280.99	\$261.32	\$241.65	\$224.79	7			
					PE2036	\$505.79	\$470.38	\$434.98	\$404.63	8			
	7,000 - 12,400	SMA			PE2030	\$505.79	\$470.38	\$434.98	\$404.63	9			
					PE2023	\$307.38	\$285.86	\$264.35	\$245.90	10			
	8,000 - 12,400	N			PE2037	\$568.46	\$528.67	\$488.88	\$454.77	11			
8,000 - 18,000			SMA	PE2007	\$280.99	\$261.32	\$241.65	\$224.79	12				
	PE2075	\$376.39		\$350.04	\$323.70	\$301.11	13						
	PE2072	\$322.63		\$300.05	\$277.46	\$258.10	14						
3 WAY	2 - 200	BNC	Female	10 Watt	PE2045	\$487.75	\$453.61	\$419.47	\$390.20	15			
		N			PE2001	\$280.99	\$261.32	\$241.65	\$224.79	16			
	2 - 500	SMA			PE2047	\$276.38	\$257.03	\$237.69	\$221.10	17			
					BNC	PE2004	\$370.87	\$344.91	\$318.95	\$296.70	18		
	10 - 1,000	SMA			PE2009	\$370.87	\$344.91	\$318.95	\$296.70	19			
					N	PE2038	\$703.94	\$654.66	\$605.39	\$563.15	20		
	500 - 1,000	SMA			PE2076	\$537.81	\$500.16	\$462.52	\$430.25	21			
					N	PE2073	\$430.25	\$400.13	\$370.02	\$344.20	22		
	4 WAY	800 - 2,500			SMA	Female	10 Watt	PE2012	\$415.81	\$386.70	\$357.60	\$332.65	23
								N	PE2039	\$730.59	\$679.45	\$628.31	\$584.47
		1,000 - 2,000			SMA			PE2015	\$449.60	\$418.13	\$386.66	\$359.68	25
PE2031			\$467.18	\$434.48				\$401.77	\$373.74	26			
2,000 - 4,000		SMA	PE2029	\$867.54	\$806.81			\$746.08	\$694.03	27			
			N	PE2018	\$370.87			\$344.91	\$318.95	\$296.70	28		
2,000 - 8,000		SMA	PE2041	\$674.35	\$627.15			\$579.94	\$539.48	29			
			PE2021	\$370.87	\$344.91			\$318.95	\$296.70	30			
4,000 - 8,000		N	PE2042	\$618.21	\$574.94			\$531.66	\$494.57	31			
			PE2027	\$419.66	\$390.28			\$360.91	\$335.73	32			
7,000 - 12,400		SMA	PE2024	\$393.41	\$365.87			\$338.33	\$314.73	33			
	N		PE2043	\$674.35	\$627.15	\$579.94	\$539.48	34					
6 WAY	1 - 175	BNC	Female	1 Watt	PE2006	\$427.06	\$397.17	\$367.27	\$341.65	35			
8 WAY	2 - 500	BNC	Female	10 Watt	PE2046	\$597.49	\$555.67	\$513.84	\$477.99	36			
					PE2002	\$449.60	\$418.13	\$386.66	\$359.68	37			
					PE2034	\$505.79	\$470.38	\$434.98	\$404.63	38			
12 WAY	2 - 500	BNC	Female	1 Watt	PE2005	\$618.21	\$574.94	\$531.66	\$494.57	39			

See Our Website For Real-Time Stock Availability!

Couplers and Dividers

EHF or Extremely High Frequency has frequencies ranging from 30 to 300GHz.



Free Freight Available via UPS Ground to USA & Canada



Real-Time Stock Levels & Pricing On Our WebSite



Toll-Free Technical Support (866) 727-8376



Same-Day Shipping, Even Custom Cable Assemblies

# 75 OHM

## Reactive

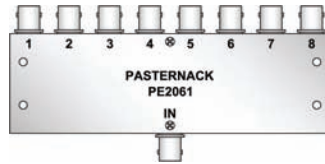

Ports	Freq. Range (MHz.)	Connector	Gender	Maximum Power	Model No	1-24	25-49	50-99	100+	R O W
2 WAY	2 - 500	BNC	Female	1 Watt	PE2048	\$293.86	\$273.29	\$252.72	\$235.09	1
	10 - 1,000	BNC	Female	1 Watt	PE2062	\$303.43	\$282.19	\$260.95	\$242.74	2
4 WAY	2 - 500	BNC	Female	1 Watt	PE2049	\$325.88	\$303.07	\$280.26	\$260.70	3
8 WAY	2 - 500	BNC	Female	1 Watt	PE2061	\$561.98	\$522.64	\$483.30	\$449.58	4

# MISC. RF. COMPONENTS

## CONNECTOR CAPS

### Caps



SMA

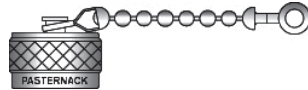

N



N

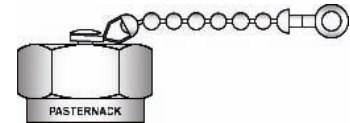

7/16 DIN

Connector	Gender	Compatible With	Chain	Model No	1-24	25-49	50-99	100+	R O W
SMA	Male	50 OHM	No	PE6024	\$7.14	\$6.64	\$6.14	\$5.71	5
			Yes	PE6019	\$8.16	\$7.59	\$7.02	\$6.53	6
	Female		No	PE6120	\$16.36	\$15.21	\$14.07	\$13.09	7
			Yes	PE6119	\$16.36	\$15.21	\$14.07	\$13.09	8
SSMA	Male	50 OHM	No	PE6020	\$8.36	\$7.77	\$7.19	\$6.69	9
N	Male	50 OHM	No	PE6017	\$5.47	\$5.09	\$4.70	\$4.38	10
			Yes	PE6016	\$5.17	\$4.81	\$4.45	\$4.14	11
	Female		No	PE6116	\$6.28	\$5.84	\$5.40	\$5.02	12
			Yes	PE6018	\$7.60	\$7.07	\$6.54	\$6.08	13
TNC	Male	50 OHM	No	PE6144	\$6.43	\$5.98	\$5.53	\$5.14	14
			Yes	PE6023	\$7.03	\$6.54	\$6.05	\$5.62	15
	Female		No	PE6143	\$8.56	\$7.96	\$7.36	\$6.85	16
			Yes	PE6021	\$8.51	\$7.91	\$7.32	\$6.81	17
7/16 DIN	Male	50 OHM	Yes	PE6057	\$32.37	\$30.10	\$27.84	\$25.90	18
	Female		Yes	PE6058	\$32.88	\$30.58	\$28.28	\$26.30	19
UHF	Male	50 OHM	No	PE6017-UHF	\$5.47	\$5.09	\$4.70	\$4.38	20
			Yes	PE6016-UHF	\$5.17	\$4.81	\$4.45	\$4.14	21
SMC	Plug	50 OHM	Yes	PE6123	\$11.70	\$10.88	\$10.06	\$9.36	22
		75 OHM	Yes	PE6126	\$25.43	\$23.65	\$21.87	\$20.34	23
		50 OHM	Yes	PE6124	\$11.70	\$10.88	\$10.06	\$9.36	24
SC	Male	50 OHM	Yes	PE6117	\$82.33	\$76.57	\$70.80	\$65.86	25
	Female		Yes	PE6118	\$70.68	\$65.73	\$60.78	\$56.54	26
HN	Male	50 OHM	No	PE6113	\$14.69	\$13.66	\$12.63	\$11.75	27
			Yes	PE6059	\$20.37	\$18.94	\$17.52	\$16.30	28
	Female		No	PE6115	\$19.96	\$18.56	\$17.17	\$15.97	29
			Yes	PE6114	\$21.13	\$19.65	\$18.17	\$16.90	30
SMB	Plug	50 OHM	Yes	PE6121	\$17.63	\$16.40	\$15.16	\$14.10	31
		75 OHM	Yes	PE6125	\$25.89	\$24.08	\$22.27	\$20.71	32
		50 OHM	Yes	PE6122	\$8.56	\$7.96	\$7.36	\$6.85	33

# Caps

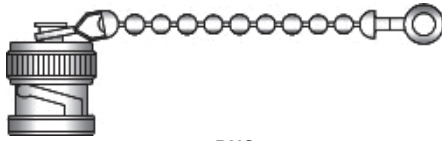

BNC



C

Connector	Gender	Compatible With	Chain	Model No	1-24	25-49	50-99	100+	ROW
BNC	Male	50 OHM	No	PE6014	\$3.50	\$3.26	\$3.01	\$2.80	1
			Yes	PE6013	\$6.03	\$5.61	\$5.19	\$4.82	2
	Female		No	PE6108	\$5.83	\$5.42	\$5.01	\$4.66	3
			Yes	PE6015	\$4.91	\$4.57	\$4.22	\$3.93	4
C	Male	50 OHM	No	PE6109	\$14.69	\$13.66	\$12.63	\$11.75	5
			Yes	PE6046	\$15.45	\$14.37	\$13.29	\$12.36	6
	Female		No	PE6111	\$18.75	\$17.44	\$16.13	\$15.00	7
	Female		Yes	PE6110	\$19.66	\$18.28	\$16.91	\$15.73	8

# Shorts

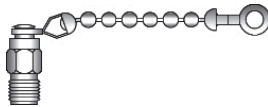

SMA



N



BNC

Connector	Gender	Compatible With	Chain	Model No	1-24	25-49	50-99	100+	ROW
SMA	Male	50 OHM	No	PE6006	\$15.81	\$14.70	\$13.60	\$12.65	9
			Yes	PE6131	\$18.49	\$17.20	\$15.90	\$14.79	10
	Female		No	PE6007	\$17.18	\$15.98	\$14.77	\$13.74	11
			Yes	PE6132	\$18.75	\$17.44	\$16.13	\$15.00	12
N	Male	50 OHM	No	PE6022	\$15.05	\$14.00	\$12.94	\$12.04	13
			Yes	PE6129	\$17.88	\$16.63	\$15.38	\$14.30	14
	Female		No	PE6031	\$16.16	\$15.03	\$13.90	\$12.93	15
			Yes	PE6130	\$19.96	\$18.56	\$17.17	\$15.97	16
TNC	Male	50 OHM	No	PE6133	\$15.05	\$14.00	\$12.94	\$12.04	17
			Yes	PE6134	\$18.75	\$17.44	\$16.13	\$15.00	18
	Female		No	PE6135	\$15.05	\$14.00	\$12.94	\$12.04	19
			Yes	PE6136	\$18.75	\$17.44	\$16.13	\$15.00	20
BNC	Male	50 OHM	No	PE6012	\$7.71	\$7.17	\$6.63	\$6.17	21
			Yes	PE6127	\$13.48	\$12.54	\$11.59	\$10.78	22
	Female		No	PE6030	\$10.39	\$9.66	\$8.94	\$8.31	23
			Yes	PE6128	\$14.49	\$13.48	\$12.46	\$11.59	24

# DC BLOCKS



SMA

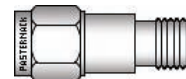

2.92mm

Impedance	Connector	Frequency Range (MHz.)	Type	Max. V (V)	Model No	1-24	25-49	50-99	100+	ROW
50 OHM	SMA	10 - 18,000	Inner	200	PE8210	\$94.54	\$87.92	\$81.30	\$75.63	25
				950	PE8250	\$95.55	\$88.86	\$82.17	\$76.44	26
			Outer	200	PE8211	\$162.08	\$150.73	\$139.39	\$129.66	27
				950	PE8212	\$186.95	\$173.86	\$160.78	\$149.56	28
	2.92mm	10 - 26,500	Inner	200	PE8222	\$213.30	\$198.37	\$183.44	\$170.64	29
				950	PE8223	\$231.29	\$215.10	\$198.91	\$185.03	30
			Outer	200	PE8224	\$320.66	\$298.21	\$275.77	\$256.53	31
				950	PE8224	\$320.66	\$298.21	\$275.77	\$256.53	31

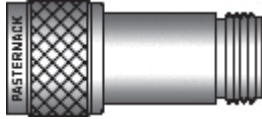

N

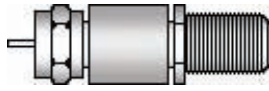

F



BNC

Impedance	Connector	Frequency Range (MHz.)	Type	Max. V (V)	Model No	1-24	25-49	50-99	100+	ROW		
50 OHM	2.92mm	10 - 40,000	Inner	200	PE8225	\$578.85	\$538.33	\$497.81	\$463.08	1		
			Outer		PE8226	\$870.73	\$809.78	\$748.83	\$696.58	2		
			Inner/Outer		PE8227	\$953.77	\$887.01	\$820.24	\$763.02	3		
	2.4mm	100 - 50,000	Inner	75	PE8237	\$1,177.45	\$1,095.03	\$1,012.61	\$941.96	4		
			Outer		PE8238	\$1,530.69	\$1,423.54	\$1,316.39	\$1,224.55	5		
			Inner/Outer		PE8239	\$1,530.69	\$1,423.54	\$1,316.39	\$1,224.55	6		
	N	10 - 18,000	Inner	200	PE8213	\$116.07	\$107.95	\$99.82	\$92.86	7		
					Outer	PE8251	\$133.15	\$123.83	\$114.51	\$106.52	8	
					Inner/Outer	PE8214	\$156.20	\$145.27	\$134.33	\$124.96	9	
			TNC	Inner	200	PE8215	\$210.51	\$195.77	\$181.04	\$168.41	10	
						Outer	PE8219	\$179.00	\$166.47	\$153.94	\$143.20	11
						Inner/Outer	PE8252	\$201.75	\$187.63	\$173.51	\$161.40	12
	BNC	10 - 4,000	Inner	200	PE8220	\$214.06	\$199.08	\$184.09	\$171.25	13		
					Outer	PE8221	\$275.87	\$256.56	\$237.25	\$220.70	14	
Inner/Outer			200	PE8216	\$149.01	\$138.58	\$128.15	\$119.21	15			
				PE8217	\$181.99	\$169.25	\$156.51	\$145.59	16			
75 OHM	N	100 - 4,000	Inner/Outer	200	PE8218	\$247.25	\$229.94	\$212.64	\$197.80	17		
					PE8234	\$201.75	\$187.63	\$173.51	\$161.40	18		
					PE8235	\$216.90	\$201.72	\$186.53	\$173.52	19		
	F	10 - 2,000	Inner/Outer	200	PE8236	\$285.45	\$265.47	\$245.49	\$228.36	20		
					PE8240	\$78.99	\$73.46	\$67.93	\$63.19	21		
					PE8241	\$139.48	\$129.72	\$119.95	\$111.58	22		
	BNC	100 - 4,000	Inner/Outer	200	PE8242	\$164.56	\$153.04	\$141.52	\$131.65	23		
					PE8231	\$206.31	\$191.87	\$177.43	\$165.05	24		
					PE8232	\$170.44	\$158.51	\$146.58	\$136.35	25		
			PE8233	\$273.14	\$254.02	\$234.90	\$218.51	26				

# BIAS TEES



SMA



2.92mm

Impedance	Frequency Range (MHz.)	Max. V (V)	Max. I (mA)	Connector	Bias Connector	Model No	1-24	25-49	50-99	100+	ROW
50 OHM	0.1 - 12,400	24	750	SMA	Solder Pin	PE1606	\$382.01	\$355.27	\$328.53	\$305.61	27
	0.1 - 18,000					PE1607	\$458.57	\$426.47	\$394.37	\$366.86	28
	0.1 - 26,500					PE1608	\$909.34	\$845.69	\$782.03	\$727.47	29
	0.1 - 40,000	25	250	2.92mm	SMA Female	PE1609	\$1,524.81	\$1,418.07	\$1,311.34	\$1,219.85	30
	0.1 - 50,000					PE1610	\$1,878.00	\$1,746.54	\$1,615.08	\$1,502.40	31
	10 - 2,500	100	2,500	SMA	Solder Pin	PE1611	\$235.44	\$218.96	\$202.48	\$188.35	32
	10 - 4,000			N		PE1612	\$231.49	\$215.29	\$199.08	\$185.19	33
	10 - 6,000			SMA		PE1613	\$301.71	\$280.59	\$259.47	\$241.37	34
				N		PE1614	\$294.31	\$273.71	\$253.11	\$235.45	35
	100 - 6,000			SMA		PE1615	\$263.66	\$245.20	\$226.75	\$210.93	36
				N		PE1616	\$294.31	\$273.71	\$253.11	\$235.45	37
	250 - 2,500	50	500	SMA	PE1604	\$219.68	\$204.30	\$188.92	\$175.74	38	
	500 - 10,000			PE1617	\$529.80	\$492.71	\$455.63	\$423.84	39		
				PE1618	\$582.80	\$542.00	\$501.21	\$466.24	40		
	1000 - 5,000	50	1,000	SMA	PE1605	\$353.24	\$328.51	\$303.79	\$282.59	41	
					PE1603	\$208.33	\$193.75	\$179.16	\$166.66	42	

# FILTERS

## SMA Connectors

### Bandpass Filters



Bandpass Filters



Bandpass Filters

Description	Bandpass Frequency (MHz)	Rejection (MHz)	Max. Insertion Loss (dB)	Model No	1-24	25-49	50-99	100+	ROW
ISM & RFID	902 - 928	± 100	1.5	PE8700	\$376.39	\$350.04	\$323.70	\$301.11	1
ISM, WiFi, Bluetooth, Zigbee	2,400 - 2,500	± 400	1	PE8701	\$376.39	\$350.04	\$323.70	\$301.11	2
ISM, WiFi	5,725 - 5,875	± 600	1	PE8702	\$376.39	\$350.04	\$323.70	\$301.11	3
GPS L1	1,565 - 1,585	± 100	1.5	PE8703	\$376.39	\$350.04	\$323.70	\$301.11	4
GPS L2	1,217 - 1,237	± 100	1.3	PE8704	\$430.25	\$400.13	\$370.02	\$344.20	5
GSM	824 - 849	± 100	1.5	PE8705	\$376.39	\$350.04	\$323.70	\$301.11	6
	869 - 894	50dB at ± 100		PE8706	\$376.39	\$350.04	\$323.70	\$301.11	7
PCS	1,850 - 1,910	50dB at ± 250	1.5	PE8707	\$376.39	\$350.04	\$323.70	\$301.11	8
	1,930 - 1,990			PE8708	\$376.39	\$350.04	\$323.70	\$301.11	9
UMTS	1,920 - 1,980	50 dB at ± 250	1.5	PE8709	\$376.39	\$350.04	\$323.70	\$301.11	10
UMTS/AWS	1,710 - 1,770	50 dB at ± 250	1.5	PE8710	\$376.39	\$350.04	\$323.70	\$301.11	11
	2,110 - 2,170			PE8711	\$376.39	\$350.04	\$323.70	\$301.11	12
WIMAX	2,500 - 2,700	50 dB at ± 900	1	PE8712	\$376.39	\$350.04	\$323.70	\$301.11	13
	3,300 - 3,700	50 dB at ± 1,900	0.75	PE8713	\$376.39	\$350.04	\$323.70	\$301.11	14
	4,900 - 5,900	50 dB at ± 5,000		PE8714	\$376.39	\$350.04	\$323.70	\$301.11	15

### Lowpass Filters



Lowpass Filters

Description	Bandpass Frequency (MHz)	Rejection (MHz)	Max. Insertion Loss (dB)	Model No	1-24	25-49	50-99	100+	ROW
-	DC - 30	60 dB at + 60	1	PE8723	\$253.33	\$235.60	\$217.86	\$202.66	16
	DC - 100	60 dB at + 200		PE8719	\$253.33	\$235.60	\$217.86	\$202.66	17
	DC - 225	60 dB at + 450		PE8722	\$253.33	\$235.60	\$217.86	\$202.66	18
	DC - 300	60 dB at + 600		PE8724	\$253.33	\$235.60	\$217.86	\$202.66	19
	DC - 400	60 dB at + 800		PE8726	\$253.33	\$235.60	\$217.86	\$202.66	20
	DC - 700	60 dB at + 1,400		PE8727	\$253.33	\$235.60	\$217.86	\$202.66	21
	DC - 1,000	60 dB at + 2,000		PE8720	\$253.33	\$235.60	\$217.86	\$202.66	22
	DC - 2,000	60 dB at + 4,000		PE8721	\$253.33	\$235.60	\$217.86	\$202.66	23
	DC - 3,000	60 dB at + 6,000		PE8725	\$253.33	\$235.60	\$217.86	\$202.66	24

### Highpass Filters



Highpass Filters

Description	Bandpass Frequency (MHz)	Rejection (MHz)	Max. Insertion Loss (dB)	Model No	1-24	25-49	50-99	100+	ROW
-	30 - 300	60 dB at - 15	1	PE8717	\$278.66	\$259.15	\$239.65	\$222.93	25
	100 - 750	60 dB at - 50		PE8716	\$278.66	\$259.15	\$239.65	\$222.93	26
	300 - 1,000	60 dB at - 150		PE8718	\$278.66	\$259.15	\$239.65	\$222.93	27
	1,000 - 2,500	60 dB at - 500		PE8715	\$278.66	\$259.15	\$239.65	\$222.93	28





# CIRCULATORS AND ISOLATORS

## Circulators

### SMA Connectors



SMA Connectors - Female

Frequency Range (MHz.)	Maximum Power	VSWR Max.	Isolation (dB Min.)	Model No	1-24	25-49	50-99	100+	ROW		
1,000 - 2,000	10 Watt	1.35:1	18	PE8400	\$611.27	\$568.48	\$525.69	\$489.02	1		
2,000 - 4,000		1.30:1		PE8401	\$407.09	\$378.59	\$350.10	\$325.67	2		
4,000 - 8,000		1.25:1	20	PE8402	\$242.18	\$225.23	\$208.27	\$193.74	3		
7,000 - 12,400				PE8403	\$210.21	\$195.50	\$180.78	\$168.17	4		
8,000 - 18,000				1.45:1	16	PE8404	\$246.23	\$228.99	\$211.76	\$196.98	5
11,000 - 18,000				20	PE8405	\$213.70	\$198.74	\$183.78	\$170.96	6	
18,000 - 26,500				1.40:1	17	PE8406	\$235.49	\$219.01	\$202.52	\$188.39	7

### N Connectors



N Connectors - Female

Frequency Range (MHz.)	Maximum Power	VSWR Max.	Isolation (dB Min.)	Model No	1-24	25-49	50-99	100+	ROW
1,000 - 2,000	10 Watt	1.35:1	18	PE8410	\$726.79	\$675.91	\$625.04	\$581.43	8
2,000 - 4,000		1.30:1		PE8411	\$557.72	\$518.68	\$479.64	\$446.18	9
4,000 - 8,000		1.25:1	20	PE8412	\$445.04	\$413.89	\$382.73	\$356.03	10
7,000 - 12,400				PE8413	\$422.55	\$392.97	\$363.39	\$338.04	11

## Isolators

### SMA Connectors



SMA Connectors - Female

Frequency Range (MHz.)	Maximum Power	VSWR Max.	Isolation (dB Min.)	Model No	1-24	25-49	50-99	100+	ROW		
1,000 - 2,000	20 Watt	1.35:1	18	PE8300	\$520.73	\$484.28	\$447.83	\$416.58	12		
2,000 - 4,000		1.30:1		PE8301	\$403.14	\$374.92	\$346.70	\$322.51	13		
4,000 - 8,000		1.45:1	16	PE8302	\$239.49	\$222.73	\$205.96	\$191.59	14		
7,000 - 12,400				PE8303	\$214.46	\$199.45	\$184.44	\$171.57	15		
8,000 - 18,000				20	PE8304	\$237.11	\$220.51	\$203.91	\$189.69	16	
11,000 - 18,000				1.25:1	20	PE8305	\$210.21	\$195.50	\$180.78	\$168.17	17
18,000 - 26,500				1.40:1	17	PE8306	\$235.49	\$219.01	\$202.52	\$188.39	18

HN connector is  
a high voltage N connector

# Isolators

## N Connectors

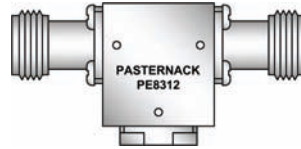

N Connectors - Female

Frequency Range (MHz.)	Maximum Power	VSWR Max.	Isolation (dB Min.)	Model No	1-24	25-49	50-99	100+	ROW
1,000 - 2,000	20 Watt	1.35:1	18	PE8310	\$726.79	\$675.91	\$625.04	\$581.43	1
2,000 - 4,000		1.30:1		PE8311	\$557.72	\$518.68	\$479.64	\$446.18	2
4,000 - 8,000		1.25:1	20	PE8312	\$445.04	\$413.89	\$382.73	\$356.03	3
7,000 - 12,400		PE8313	\$422.55	\$392.97	\$363.39	\$338.04	4		

# PHASE SHIFTERS AND TRIMMERS

## Phase Trimmers



SMA Adapter

Connector	Gender	Frequency Range (MHz.)	Deg. Phase Adjustment per GHz	Max. Insertion Loss (dB)	Model No	1-24	25-49	50-99	100+	ROW
SMA Adapter	Female	DC - 18,000	10	0.5	PE8200	\$217.09	\$201.89	\$186.70	\$173.67	5
SMA for RG405	Female	DC - 18,000	10	0.5	PE8202	\$192.83	\$179.33	\$165.83	\$154.26	6

## Phase Shifters



SMA

Connector	Gender	Frequency Range (MHz.)	Deg. Phase Adjustment per GHz	Max. Insertion Loss (dB)	Model No	1-24	25-49	50-99	100+	ROW
SMA	Female	DC - 2,000	60	0.5	PE8243	\$694.62	\$646.00	\$597.37	\$555.70	7
		DC - 4,000			PE8244	\$800.00	\$744.00	\$688.00	\$640.00	8
		DC - 8,000			PE8245	\$810.44	\$753.71	\$696.98	\$648.35	9
		DC - 12,000			PE8246	\$883.09	\$821.27	\$759.46	\$706.47	10
		DC - 18,000			PE8247	\$917.14	\$852.94	\$788.74	\$733.71	11
2.92 mm	Female	18,000 - 26,500	30	1.5	PE8253	\$971.35	\$903.36	\$835.36	\$777.08	12
		26,500 - 40,000	30	2.5	PE8254	\$1,761.42	\$1,638.12	\$1,514.82	\$1,409.14	13



# SURGE PROTECTORS

## In-Line Surge Protectors

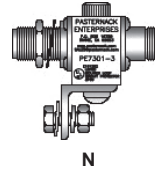
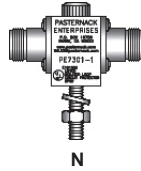

Impedance	Connector	Gender	Frequency Range (MHz.)	Mount Type	Maximum Power	Model No	1-24	25-49	50-99	100+	ROW	
50 OHM	N	Male To Female	DC - 1,000	None		PE7300-1	\$81.67	\$75.95	\$70.24	\$65.34	1	
						PE7300-2	\$81.67	\$75.95	\$70.24	\$65.34		
						PE7300-3	\$81.67	\$75.95	\$70.24	\$65.34		
		Female To Female	DC - 3,000	Bulkhead		200 Watt	PE7301-1	\$101.13	\$94.05	\$86.97	\$80.90	2
						2,000 Watt	PE7301-2	\$112.32	\$104.46	\$96.60	\$89.86	
						200 Watt	PE7301-3	\$134.52	\$125.10	\$115.69	\$107.62	
					2,000 Watt	PE7301-4	\$134.52	\$125.10	\$115.69	\$107.62		

## Manual Coax Switch with Surge Protectors

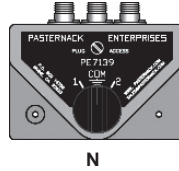

Impedance	Connector	Gender	Number of Output Ports	Frequency Range (MHz.)	Maximum Power	Model No	1-24	25-49	50-99	100+	ROW
50 OHM	N	Female	2	DC - 1,300	1,500 Watt	PE7139	\$162.08	\$150.73	\$139.39	\$129.66	3
			4	DC - 1,000		PE7140	\$188.37	\$175.18	\$162.00	\$150.70	4

## Replacement Cartridges



Cartridge For	Maximum Power	Model No	1-24	25-49	50-99	100+	ROW
PE7301	2,000 Watt	PE7301-2000CART	\$17.68	\$16.44	\$15.20	\$14.14	5
	200 Watt	PE7301-200CART	\$17.68	\$16.44	\$15.20	\$14.14	
PE7139	1,500 Watt	PE7139-CART	\$22.60	\$21.02	\$19.44	\$18.08	6

## Notes

# INDEX GUIDE TO AMPLIFIERS, MIXERS, MULTIPLIERS, DETECTORS, LIMITERS, NOISE SOURCES AND SWITCHES

## AMPLIFIERS, MIXERS AND FREQUENCY MULTIPLIERS.....212

### AMPLIFIERS.....212



Pasternack amplifiers are available in general purpose and low noise amplifier designs. Our general purpose amplifiers offer gains to 21 dB and output power up to 16 dBm at frequencies with broadband designs from 10MHz to 3 GHz. The Pasternack line of low noise amplifier (LNA) designs offer gain performance to 25 dB and noise figure levels as low as 2.5 dB with models operating as low as 50 MHz and as high as 18 GHz.

Broadband Amplifiers.....212 Low Noise Amplifiers.....212

### MIXERS.....212



Double Balanced Mixers are available with SMA female connectors with options that have RF operating frequencies ranging from 2 GHz to 18 GHz.

SMA Connectors.....212

### FREQUENCY MULTIPLIERS.....213



Frequency Doublers are available with SMA female connectors and input frequencies ranging from 1.5 GHz to 13 GHz.

SMA Connectors.....213

## DETECTORS / LIMITERS, NOISE SOURCES.....213

### DETECTORS.....213



Our line of connectorized Detectors include biased and zero bias Schottky Diode Detectors, as well as Log Detectors. Options for .01 to 26.5 GHz. detectors are available.

Biased Detectors.....214 Zero Bias Detectors.....213  
Log Detectors.....214

### LIMITERS.....214



Limiters provide attenuation at increased power levels, usually to protect a system from excessive input power levels. PIN-PIN and PIN-Schottky configurations are available from 0.5 to 18 GHz in octave and multi-octave designs.

PIN-PIN.....214 PIN-Schottky.....215

### NOISE SOURCES.....215



Pasternack octave and multi-octave band noise sources operate from 1 to 18 GHz with two design families offering general purpose and high output models. Our general purpose designs offer noise outputs (ENR) to 15.d dB, while our high output designs are capable of noise outputs (ENR) to 35 dB. In both the general purpose and high output designs, the output is a SMA Male connector and the DC Bias input is a BNC Female connector.

Medium Noise Source.....215 High Noise Source.....216

## SWITCHES.....216

### PIN SWITCHES.....217



Coaxial PIN switches with SMA female connectors are available in SPST, SPDT, SP3T, and SP4T versions operating from 10 MHz to 18 GHz.

### RELAY SWITCHES.....216



Relay switches in SPDT, SP4T, SP6T, SP10T, DPDT, and transfer switch configurations up to 18 GHz. Other switch options include latching, terminated, failsafe and normally open models.

Amplifiers, Mixers  
and Multipliers



# AMPLIFIERS

## Broadband Amplifiers

SMA Connectors



Frequency Range (MHz.)	Gain (dB Min.)	Output P1dB (dBm Min.)	Noise Figure (dB Max.)	Operating Voltage (VDC)	Model No	1-24	25-49	50-99	100+	ROW
20 - 2,500	19	15	6	9 to 15	PE1525	\$322.63	\$300.05	\$277.46	\$258.10	1
100 - 3,000	12	10	5.5		PE1514	\$337.18	\$313.58	\$289.97	\$269.74	2
	20	13	2.7		PE1513	\$337.18	\$313.58	\$289.97	\$269.74	3
	18	16	6		PE1516	\$337.18	\$313.58	\$289.97	\$269.74	4
	13		7		PE1515	\$337.18	\$313.58	\$289.97	\$269.74	5

## Low Noise Amplifiers

SMA Connectors



Frequency Range (MHz.)	Gain (dB Min.)	Output P1dB (dBm Min.)	Noise Figure (dB Max.)	Operating Voltage (VDC)	Model No	1-24	25-49	50-99	100+	ROW
50 - 1,000	21	12	3.5	12	PE1517	\$401.87	\$373.74	\$345.61	\$321.50	6
50 - 2,000					PE1518	\$393.41	\$365.87	\$338.33	\$314.73	7
1,000 - 4,000	25	15	2.5		PE1519	\$561.98	\$522.64	\$483.30	\$449.58	8
2,000 - 4,000					PE1520	\$520.94	\$484.47	\$448.01	\$416.75	9
2,000 - 6,000			3		PE1521	\$505.79	\$470.38	\$434.98	\$404.63	10
2,000 - 18,000	21	13	3.5	PE1524	\$804.66	\$748.33	\$692.01	\$643.73	11	
4,000 - 8,000	25	15	3	PE1522	\$520.94	\$484.47	\$448.01	\$416.75	12	
6,000 - 18,000	21	13	3.5	PE1523	\$753.95	\$701.17	\$648.40	\$603.16	13	

# MIXERS

SMA Connectors

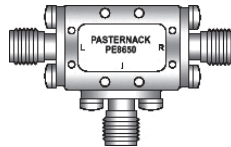

Mixer Type	Impedance	RF Range (MHz.)	IF Range (MHz.)	LO (dBm)	IIP3 (dBm)	Model No	1-24	25-49	50-99	100+	ROW
Double Balanced	50 OHM	2,000 - 8,000	0 - 1,500	10	14	PE8650	\$520.28	\$483.86	\$447.44	\$416.22	14
			100 - 4,000			PE8651	\$629.31	\$585.26	\$541.21	\$503.45	15

Continued on Next Page



## SMA Connectors

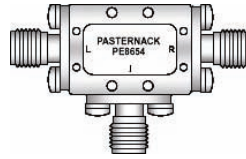

Mixer Type	Impedance	RF Range (MHz.)	IF Range (MHz.)	LO (dBm)	IIP3 (dBm)	Model No	1-24	25-49	50-99	100+	ROW
Double Balanced	50 OHM	2,000 - 18,000	0 - 600	10	13	PE8652	\$674.60	\$627.38	\$580.16	\$539.68	1
		5,000 - 18,000	0 - 4,000		14	PE8653	\$741.79	\$689.86	\$637.94	\$593.43	2
		6,000 - 18,000	1,500 - 8,000		PE8654	\$741.79	\$689.86	\$637.94	\$593.43	3	

## FREQUENCY MULTIPLIERS

### SMA Connectors

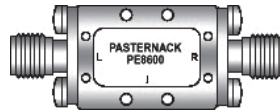

Type	Impedance	Input Range (MHz.)	Output Range (MHz.)	Conv. Loss (dB)	Fund. Isol. (dB)	Model No	1-24	25-49	50-99	100+	ROW
Doublers	50 OHM	1,500 - 5,000	3,000 - 10,000	8.5	25	PE8600	\$506.95	\$471.46	\$435.98	\$405.56	4
		2,000 - 6,000	4,000 - 12,000	11		PE8601	\$529.50	\$492.44	\$455.37	\$423.60	5
		4,000 - 9,000	8,000 - 18,000	10		PE8602	\$540.80	\$502.94	\$465.09	\$432.64	6
		9,000 - 13,000	18,000 - 26,000			PE8603	\$574.59	\$534.37	\$494.15	\$459.67	7

## DETECTORS

### Zero Bias Detectors



SMA



BNC

Impedance	Connector	Frequency Range (MHz.)	Polarity	Input Power (dB Max)	Slope (mV/mW)	TSS (dBm)	Video (pF)	Model No	1-24	25-49	50-99	100+	ROW
50 OHM	SMA	10 - 2,000	Negative	23	500	-52	470	PE8010	\$382.01	\$355.27	\$328.53	\$305.61	8
		10 - 4,000						PE8011	\$393.62	\$366.07	\$338.51	\$314.90	9
		10 - 12,400						PE8012	\$377.56	\$351.13	\$324.70	\$302.05	10
		10 - 18,500						PE8013	\$463.08	\$430.66	\$398.25	\$370.46	11
		10 - 26,500						PE8014	\$497.83	\$462.98	\$428.13	\$398.26	12
		2,000 - 4,000						PE8015	\$364.94	\$339.39	\$313.85	\$291.95	13
75 OHM	BNC	2,000 - 8,000	Positive	20	650	-40	1,000	PE8016	\$435.62	\$405.13	\$374.63	\$348.50	14
		0.1 - 1,000						PE8000-50	\$187.92	\$174.77	\$161.61	\$150.34	15
		0.1 - 1,000	Positive	20	700	-20	1,000	PE8000-75	\$168.92	\$157.10	\$145.27	\$135.14	16



Free Freight Available  
via UPS Ground  
to USA & Canada



Real-Time Stock  
Levels & Pricing  
On Our WebSite



Toll-Free Technical  
Support  
(866) 727-8376



Same-Day Shipping,  
Even Custom  
Cable Assemblies

# Biased Detectors

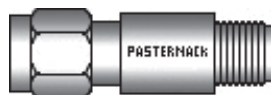

SMA

Impedance	Connector	Frequency Range (MHz.)	Polarity	Input Power (dB Max)	Slope (mV/mW)	TSS (dBm)	Video (pF)	Model No	1-24	25-49	50-99	100+	ROW		
50 OHM	SMA	500 - 1,000	Negative	23	1,800	-54	100	PE8001	\$353.24	\$328.51	\$303.79	\$282.59	1		
			Positive					PE8001-P	\$337.18	\$313.58	\$289.97	\$269.74	2		
		1,000 - 2,000	Negative					2,000	50	PE8002	\$364.94	\$339.39	\$313.85	\$291.95	3
			Positive							PE8002-P	\$348.42	\$324.03	\$299.64	\$278.74	4
		2,000 - 4,000	Negative					20	PE8003	\$412.06	\$383.22	\$354.37	\$329.65	5	
			Positive						PE8003-P	\$393.41	\$365.87	\$338.33	\$314.73	6	
		4,000 - 8,000	Negative		10	PE8004	\$412.06	\$383.22	\$354.37	\$329.65	7				
			Positive			PE8004-P	\$392.30	\$364.84	\$337.38	\$313.84	8				
		6,000 - 18,000	Negative		1,600	-52	10	PE8005	\$447.37	\$416.05	\$384.74	\$357.90	9		
			Positive					PE8005-P	\$427.06	\$397.17	\$367.27	\$341.65	10		
		8,000 - 12,000	Negative		1,800	10	PE8006	\$412.06	\$383.22	\$354.37	\$329.65	11			
			Positive				PE8006-P	\$393.41	\$365.87	\$338.33	\$314.73	12			
		8,000 - 16,000	Negative		1,600	10	PE8007	\$435.62	\$405.13	\$374.63	\$348.50	13			
			Positive				PE8007-P	\$415.81	\$386.70	\$357.60	\$332.65	14			
		8,000 - 18,000	Negative		1,600	10	PE8008	\$435.62	\$405.13	\$374.63	\$348.50	15			
			Positive				PE8008-P	\$415.81	\$386.70	\$357.60	\$332.65	16			
		18,000 - 26,000	Negative		1,500	5	PE8009	\$470.93	\$437.96	\$405.00	\$376.74	17			
			Positive				PE8009-P	\$449.60	\$418.13	\$386.66	\$359.68	18			

# Log Detectors



SMA

Impedance	Connector	Frequency Range (MHz.)	Polarity	Input Power (dB Max)	Slope (mV/mW)	TSS (dBm)	Video (pF)	Model No	1-24	25-49	50-99	100+	ROW
50 OHM	SMA	10 - 3,000	Positive	10	40			PE8040	\$391.74	\$364.32	\$336.90	\$313.39	19

# LIMITERS

## PIN - PIN

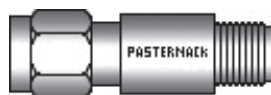

SMA

Connector	Frequency Range (MHz.)	Limiting Threshold Typ. (dBm)	Leakage @ 1W CW Input (dBm Max.)	Insertion Loss (dB Max.)	Model No	1-24	25-49	50-99	100+	ROW
SMA	500 - 1,000	9	19	0.4	PE8017	\$364.94	\$339.39	\$313.85	\$291.95	20
	500 - 2,000			0.5	PE8018	\$370.46	\$344.53	\$318.60	\$296.37	21
	1,000 - 2,000			0.4	PE8019	\$364.94	\$339.39	\$313.85	\$291.95	22
	2,000 - 4,000			0.8	PE8020	\$345.13	\$320.97	\$296.81	\$276.10	23
	2,000 - 8,000			1.2	PE8021	\$435.62	\$405.13	\$374.63	\$348.50	24
	2,000 - 18,000			2.5	PE8022	\$447.37	\$416.05	\$384.74	\$357.90	25
	4,000 - 8,000			1.2	PE8023	\$388.55	\$361.35	\$334.15	\$310.84	26

See Our Website For Real-Time Stock Availability!

Detectors/Limiters  
Noise Sources

# PIN - PIN



SMA

Connector	Frequency Range (MHz.)	Limiting Threshold Typ. (dBm)	Leakage @ 1W CW Input (dBm Max.)	Insertion Loss (dB Max.)	Model No	1-24	25-49	50-99	100+	ROW
SMA	6,000 - 18,000	9	16	2.2	PE8024	\$435.62	\$405.13	\$374.63	\$348.50	1
	7,000 - 12,000			1.5	PE8025	\$412.06	\$383.22	\$354.37	\$329.65	2
	8,000 - 16,000			2	PE8026	\$423.81	\$394.14	\$364.48	\$339.05	3
	11,000 - 18,000			2.2	PE8027	\$470.93	\$437.96	\$405.00	\$376.74	4

# PIN - Schottky



SMA

Connector	Frequency Range (MHz.)	Limiting Threshold Typ. (dBm)	Leakage @ 1W CW Input (dBm Max.)	Insertion Loss (dB Max.)	Model No	1-24	25-49	50-99	100+	ROW
SMA	500 - 1,000	9	14	0.5	PE8028	\$347.31	\$323.00	\$298.69	\$277.85	5
	500 - 2,000			0.6	PE8029	\$376.74	\$350.37	\$324.00	\$301.39	6
	1,000 - 2,000			PE8030	\$364.94	\$339.39	\$313.85	\$291.95	7	
	2,000 - 4,000			0.8	PE8031	\$382.01	\$355.27	\$328.53	\$305.61	8
	2,000 - 8,000			1.4	PE8032	\$364.94	\$339.39	\$313.85	\$291.95	9
	2,000 - 18,000			2.5	PE8033	\$447.37	\$416.05	\$384.74	\$357.90	10
	4,000 - 8,000			1.4	PE8034	\$376.74	\$350.37	\$324.00	\$301.39	11
	6,000 - 18,000			2.5	PE8035	\$447.37	\$416.05	\$384.74	\$357.90	12
	7,000 - 12,000			2	PE8036	\$435.62	\$405.13	\$374.63	\$348.50	13
	8,000 - 16,000			2.2	PE8037	\$435.62	\$405.13	\$374.63	\$348.50	14
	11,000 - 18,000			2.5	PE8038	\$470.93	\$437.96	\$405.00	\$376.74	15

# NOISE SOURCES

## Medium Noise Source



SMA Male  
BNC Female

RF Connector	Bias Connector	Frequency Range (MHz.)	Noise Output (ENR dB)	Model No	1-24	25-49	50-99	100+	ROW
SMA Male	BNC Female	1,000 - 2,000	15.5	PE8500	\$1,123.95	\$1,045.27	\$966.60	\$899.16	16
		2,000 - 4,000		PE8501	\$1,284.46	\$1,194.55	\$1,104.64	\$1,027.57	17
		4,000 - 8,000		PE8502	\$1,366.59	\$1,270.93	\$1,175.27	\$1,093.27	18
		8,000 - 12,000		PE8503	\$1,445.07	\$1,343.92	\$1,242.76	\$1,156.06	19
		12,000 - 18,000		PE8504	\$1,573.60	\$1,463.45	\$1,353.30	\$1,258.88	20



# High Noise Source



SMA Male  
SMA Female

RF Connector	Bias Connector	Frequency Range (MHz.)	Noise Output (ENR dB)	Model No	1-24	25-49	50-99	100+	ROW
SMA Male	SMA Female	1,000 - 2,000	30 - 35	PE8505	\$963.39	\$895.95	\$828.52	\$770.71	1
		2,000 - 4,000		PE8506	\$1,123.95	\$1,045.27	\$966.60	\$899.16	2
		4,000 - 8,000		PE8507	\$1,206.03	\$1,121.61	\$1,037.19	\$964.82	3
		8,000 - 12,000	PE8508	\$1,284.46	\$1,194.55	\$1,104.64	\$1,027.57	4	
		12,000 - 18,000	PE8509	\$1,412.95	\$1,314.04	\$1,215.14	\$1,130.36	5	

# SWITCHES

## Relay Switches

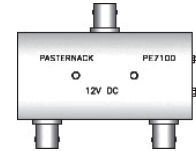
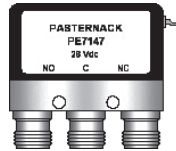

Switch Configuration	Connector	Frequency Range (MHz.)	Features	Model No	1-24	25-49	50-99	100+	ROW	
SPDT	SMA	18,000	F	PE7142	\$328.61	\$305.61	\$282.60	\$262.89	6	
			I, L, S	PE7141	\$308.85	\$287.23	\$265.61	\$247.08	7	
				PE7144	\$417.07	\$387.88	\$358.68	\$333.66	8	
				PE7143	\$794.68	\$739.05	\$683.42	\$635.74	9	
			I, P	PE7146	\$428.17	\$398.20	\$368.23	\$342.54	10	
	I, P	PE7145	\$353.24	\$328.51	\$303.79	\$282.59	11			
	N	1,000	4,000	F	PE7102	\$294.31	\$273.71	\$253.11	\$235.45	12
				PE7148	\$464.55	\$432.03	\$399.51	\$371.64	13	
		8,000	1,000	F	PE7147	\$428.17	\$398.20	\$368.23	\$342.54	14
				H, I, P	PE7149	\$2,248.11	\$2,090.74	\$1,933.37	\$1,798.49	15
PE7100		\$280.99	\$261.32	\$241.65	\$224.79	16				
SP4T	SMA	18,000	F, N	PE7158	\$653.68	\$607.92	\$562.16	\$522.94	17	
SP6T	SMA	18,000	F, N	PE7159	\$966.49	\$898.84	\$831.18	\$773.19	18	
SP10T	SMA	8,000	F, N	PE7160	\$2,478.89	\$2,305.37	\$2,131.85	\$1,983.11	19	
DPDT	SMA	18,000	F, T	PE7154	\$855.02	\$795.17	\$735.32	\$684.02	20	
			I, P	PE7155	\$786.83	\$731.75	\$676.67	\$629.46	21	
			I, P, T	PE7156	\$899.20	\$836.26	\$773.31	\$719.36	22	
			I, P, T, TTL	PE7157	\$955.44	\$888.56	\$821.68	\$764.35	23	
TRANSFER	SMA	18,000	F	PE7150	\$459.13	\$426.99	\$394.85	\$367.30	24	
			I, L, S	PE7151	\$707.44	\$657.92	\$608.40	\$565.95	25	
	N	4,000	I, P	PE7152	\$558.02	\$518.96	\$479.90	\$446.42	26	
			F	PE7153	\$577.23	\$536.82	\$496.42	\$461.78	27	
SPDT, 75 OHM	N	1,000	F	PE7103	\$280.99	\$261.32	\$241.65	\$224.79	28	
			BNC	PE7101	\$456.59	\$424.63	\$392.67	\$365.27	29	

MCX stands for "micro coaxial connector".  
They were invented in the 1980's and  
are similar to an SMB connector, but are 30% smaller.

# PIN Switches

## SMA

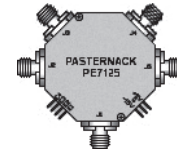
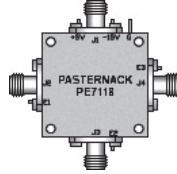
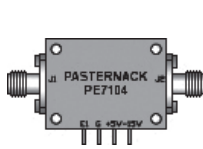

Switch Configuration	Frequency Range (MHz.)	Maximum Power	Speed (nsec Max.)	Model No	1-24	25-49	50-99	100+	ROW
SPST	10 - 1,000	1 Watt	250	PE7104	\$1,854.74	\$1,724.91	\$1,595.08	\$1,483.79	1
	1,000 - 2,000			PE7105	\$1,423.59	\$1,323.94	\$1,224.29	\$1,138.87	2
	1,000 - 18,000	0.5 Watt	100	PE7106	\$1,796.43	\$1,670.68	\$1,544.93	\$1,437.14	3
	2,000 - 4,000			PE7107	\$1,358.99	\$1,263.86	\$1,168.73	\$1,087.19	4
	4,000 - 8,000			PE7108	\$1,466.90	\$1,364.22	\$1,261.53	\$1,173.52	5
	8,000 - 12,000			PE7109	\$1,358.99	\$1,263.86	\$1,168.73	\$1,087.19	6
	12,000 - 18,000			PE7110	\$1,423.59	\$1,323.94	\$1,224.29	\$1,138.87	7
SPDT	10 - 1,000	1 Watt	250	PE7111	\$1,655.12	\$1,539.26	\$1,423.40	\$1,324.10	8
	1,000 - 2,000			PE7112	\$1,683.19	\$1,565.37	\$1,447.54	\$1,346.55	9
	1,000 - 18,000	0.5 Watt	100	PE7113	\$2,062.01	\$1,917.67	\$1,773.33	\$1,649.61	10
	2,000 - 4,000			PE7114	\$1,730.26	\$1,609.14	\$1,488.02	\$1,384.21	11
	4,000 - 8,000			PE7115	\$1,730.26	\$1,609.14	\$1,488.02	\$1,384.21	12
	8,000 - 12,000			PE7116	\$2,315.54	\$2,153.45	\$1,991.36	\$1,852.43	13
	12,000 - 18,000			PE7117	\$1,606.94	\$1,494.45	\$1,381.97	\$1,285.55	14
SP3T	10 - 1,000	1 Watt	250	PE7118	\$1,606.94	\$1,494.45	\$1,381.97	\$1,285.55	15
	1,000 - 2,000			PE7119	\$1,683.19	\$1,565.37	\$1,447.54	\$1,346.55	16
	1,000 - 18,000	0.5 Watt	100	PE7120	\$2,102.60	\$1,955.42	\$1,808.24	\$1,682.08	17
	2,000 - 4,000			PE7121	\$1,904.29	\$1,770.99	\$1,637.69	\$1,523.43	18
	4,000 - 8,000			PE7122	\$1,730.26	\$1,609.14	\$1,488.02	\$1,384.21	19
8,000 - 12,000	PE7123	\$1,812.44	\$1,685.57	\$1,558.70	\$1,449.95	20			
SP3T	12,000 - 18,000	0.5 Watt		PE7124	\$1,817.91	\$1,690.66	\$1,563.40	\$1,454.33	21
SP4T	10 - 1,000	1 Watt	250	PE7125	\$2,202.46	\$2,048.29	\$1,894.12	\$1,761.97	22
	1,000 - 2,000			PE7126	\$1,978.11	\$1,839.64	\$1,701.17	\$1,582.49	23
	1,000 - 18,000	0.5 Watt	100	PE7127	\$2,227.08	\$2,071.18	\$1,915.29	\$1,781.66	24
	2,000 - 4,000			PE7128	\$1,978.11	\$1,839.64	\$1,701.17	\$1,582.49	25
	4,000 - 8,000			PE7129	\$2,227.08	\$2,071.18	\$1,915.29	\$1,781.66	26
	8,000 - 12,000			PE7130	\$2,165.68	\$2,014.08	\$1,862.48	\$1,732.54	27
	12,000 - 18,000			PE7131	\$1,978.11	\$1,839.64	\$1,701.17	\$1,582.49	28
TRANSFER	10 - 1,000	2 Watt	100	PE7132	\$2,227.08	\$2,071.18	\$1,915.29	\$1,781.66	29
	1,000 - 2,000	1 Watt		PE7133	\$1,978.11	\$1,839.64	\$1,701.17	\$1,582.49	30
	1,000 - 18,000	0.5 Watt		PE7134	\$2,722.84	\$2,532.24	\$2,341.64	\$2,178.27	31
	2,000 - 4,000	1 Watt		PE7135	\$2,350.45	\$2,185.92	\$2,021.39	\$1,880.36	32
	4,000 - 8,000			PE7136	\$2,474.99	\$2,301.74	\$2,128.49	\$1,979.99	33
	8,000 - 12,000	0.5 Watt		PE7137	\$2,227.08	\$2,071.18	\$1,915.29	\$1,781.66	34
12,000 - 18,000	PE7138		\$2,202.46	\$2,048.29	\$1,894.12	\$1,761.97	35		

## Notes

See Our Website For Real-Time Stock Availability!

Switches



# INDEX GUIDE TO ANTENNA AND WAVEGUIDE PRODUCTS

## ANTENNAS.....219

### ANTENNA ACCESSORIES.....230

	<p>Pasternack provides an array of antenna accessories including NMO Antenna Mounts used for base station installs and land mobile radio applications. Multiple terminal connector options are available. Additional antenna accessories include magnetic mount and permanent mounts for land mobile radio applications.</p>
	<p>NMO Adapters.....230 NMO Mount, Magnetic.....230</p>

### DIRECTIONAL ANTENNAS.....223

	<p>Our line of Directional antennas includes in-ceiling Dome antennas, Fixed and Mobile GPS antennas, Panel antennas, and Yagi antennas. These antennas offer low, medium, and high gain options with corresponding variations in beam width, from broad beam/low gain to narrow beam/high gain antennas.</p>
	<p>Dome, In Ceiling.....223 GPS, Passive.....225</p>
	<p>Fixed.....224 Panel.....225</p>
	<p>GPS, Active.....225 Yagi.....227</p>

### OMNI DIRECTIONAL ANTENNAS.....219

	<p>Pasternack's offering of Omni-Directional antennas include low gain portable antennas and fixed, medium gain antennas with UV resistant radomes and rugged construction suitable for multiple applications including base stations. These antennas cover frequencies from 118 MHz through 5.8 GHz.</p>
	<p>Fixed.....219 Portable.....221</p>
	<p>Mobile.....220 Portable (Rubber Duck).....222</p>

### GAIN HORN ANTENNAS.....227

	<p>Pasternack's Standard Gain Horn antennas have frequencies ranging from 1.7 GHz to 40 GHz and gains of 10 dB, 15 dB, and 20 dB. These Gain Horn antennas can be purchased with or without waveguide to coax adapters. The range of interface types includes square WG flanges and Type N, SMA, and 2.9mm female connectors.</p>
	<p>WR-28.....229 WR-112.....228</p>
	<p>WR-34.....229 WR-137.....228</p>
	<p>WR-42.....229 WR-159.....228</p>
	<p>WR-51.....229 WR-187.....227</p>
	<p>WR-62.....229 WR-229.....227</p>
	<p>WR-75.....229 WR-284.....227</p>
	<p>WR-90.....228 WR-430.....227</p>
	<p>WR-102.....228</p>

### WAVEGUIDE TO COAX ADAPTERS.....231

#### GROOVED WAVEGUIDE FLANGES.....232

	<p>Grooved waveguide to coax adapters have CPR-XXXG flanges with an o-ring groove that will accept an o-ring seal. These adapters have right angle launch Type N connectors and cover frequencies from 1.7 GHz to 12.4 GHz.</p>
---	---

#### STANDARD WAVEGUIDE FLANGES.....231

	<p>Standard waveguide to coax adapters are available in right angle launch and end launch versions. These adapters are available in 15 different waveguide sizes, operating at frequencies from 1.7 GHz to 40 GHz. Connector options include Type N, 7mm, SMA and 2.92mm.</p>
---	---

### WAVEGUIDE TERMINATIONS.....232

#### HIGH POWER TERMINATIONS.....234

	<p>High Power Waveguide Terminations are available in 9 different waveguide interfaces, operating from 7 GHz to 40 GHz. Power ratings range from 75 Watts to 300 Watts.</p>
---	---



#### PRECISION TERMINATIONS.....232

	<p>Precision Terminations have improved VSWR where low reflections are required. These are low power terminations with average power ratings from 0.5 Watts to 2.0 Watts.</p>
--	---

#### MEDIUM POWER TERMINATIONS.....233

<p>Medium Power Terminations have average power ratings from 40 Watts to 100 Watts.</p>
---

#### WAVEGUIDE TERMINATIONS.....233

	<p>Standard Waveguide Terminations are available in 9 different models ranging in frequency from 7 GHz to 40 GHz. These general purpose waveguide terminations have average power ratings ranging from 0.5 watts to 2.0 Watts.</p>	
---	--	---

Antennas

# ANTENNAS

## Omni Directional Antennas

### Fixed



PE51027



PE51061



PE51065



PE51116

Freq. Range (MHz.)	Freq. Band	Gain	Description	Model No	1-24	25-49	50-99	100+	ROW
248-268	VHF	1.5 dBi	Vertical Omni Antenna, 790mm X 51.5mm dia., N Female, 248-268 MHz, 1.5 dBi	PE51116	\$180.67	\$168.02	\$155.38	\$144.54	1
902-928	900 ISM	4 dBi	Mini Magnetic Omni Directional Antenna, 285mm X 27mm Dia. 10 ft RG174, SMA Male, 902-928 MHz, 4 dBi	PE51027	\$25.79	\$23.98	\$22.18	\$20.63	2
			Outdoor Omni Directional Antenna, 610mm X 42mm Dia., N Female, 902-928 MHz, 4 dBi	PE51028	\$170.99	\$159.02	\$147.05	\$136.79	3
2,300	WIMAX	3 dBi	Mini Ground Independent Dipole Vertical, Fiberglass Radome, 104mm X 16.7 Dia, N Male, 2300 MHz, 3 dBi	PE51062	\$155.95	\$145.03	\$134.12	\$124.76	4
2,400-2,483	Wi-Fi, ISM	8 dBi	Omni Directional Extreme Weather Antenna with mounting Bracket, 20.2mm X 1.25mm Dia., N Female, 2400-2483 MHz, 8 dBi	PE51017	\$170.99	\$159.02	\$147.05	\$136.79	5
	2.4 GHz ISM, Wi Fi		Vertical Omni Antenna, Fiberglass Radome, 600mm X 25mm dia., N Female, 2400-2483 MHz, 8 dBi	PE51029	\$120.43	\$112.00	\$103.57	\$96.34	6
		10 dBi	Vertical Omni Antenna, 1000mm X 25mm dia., Fiberglass Radome, N Female, 2400-2483 MHz, 10 dBi	PE51030	\$131.17	\$121.99	\$112.81	\$104.94	7
	12 dBi	Vertical Omni Antenna, 1200mm X 25mm dia., Fiberglass Radome, N Female, 2400-2483 MHz, 12 dBi	PE51031	\$141.91	\$131.98	\$122.04	\$113.53	8	
2,400-2,500	Wi-Fi, ISM	8 dBi	Vertical Omni Antenna, 500mm X 19mm Dia, N Female, 2400-2500 MHz, 8 dBi	PE51061	\$146.27	\$136.03	\$125.79	\$117.02	9
2,400	Wi-Fi	3 dBi	Mini Dipole Vertical, Fiberglass Radome, 104mm X 16.7mm Dia, N Male, 2400 MHz, 3 dBi	PE51063	\$158.07	\$147.01	\$135.94	\$126.46	10
2,500	WIMAX	3 dBi	Mini Dipole Vertical, Fiberglass Radome, 104mm X 16.7mm Dia, N Male, 2500 MHz, 3 dBi	PE51064	\$158.07	\$147.01	\$135.94	\$126.46	11
3,400-3,600	3.5 GHz WiMax	7 dBi	Vertical Omni Antenna, 500mm X 25mm, Fiberglass Radome, N Female, 3400-3600 MHz, 7 dBi	PE51032	\$128.99	\$119.96	\$110.93	\$103.19	12
		9 dBi	Vertical Omni Antenna, 800mm X 25mm dia., Fiberglass Radome, N Female, 3400-3600 MHz, 9 dBi	PE51033	\$139.73	\$129.95	\$120.17	\$111.78	13
		11 dBi	Vertical Omni Antenna, 1000mm X 25mm dia., Fiberglass Radome, N Female, 3400-3600 MHz, 11 dBi	PE51034	\$150.58	\$140.04	\$129.50	\$120.46	14
3,500	WIMAX	3 dBi	Mini Dipole Vertical, Fiberglass Radome, 104mm X 16.7mm Dia., N Male, 3500 MHz, 3 dBi	PE51065	\$159.14	\$148.00	\$136.86	\$127.31	15
5,470-5,850	5.5 GHz WiMax	8 dBi	Vertical Omni Antenna, 380mm X 25mm dia., Fiberglass Radome, N Female, 5470-5850 MHz, 8 dBi	PE51035	\$134.41	\$125.00	\$115.59	\$107.53	16
		10 dBi	Vertical Omni Antenna, 580mm X 25mm dia., Fiberglass Radome, N Female, 5470-5850 MHz, 10 dBi	PE51036	\$150.58	\$140.04	\$129.50	\$120.46	17
		12 dBi	Vertical Omni Antenna, 750mm X 25mm dia., Fiberglass Radome, N Female, 5470-5850 MHz, 12 dBi	PE51037	\$166.69	\$155.02	\$143.35	\$133.35	18
		8 dBi	Vertical Omni Antenna, 380mm X 25mm dia., Fiberglass Radome, N Female, 5470-5850 MHz, 8 dBi	PE51038	\$134.41	\$125.00	\$115.59	\$107.53	19
		10 dBi	Vertical Omni Antenna, 580mm X 25mm dia., Fiberglass Radome, N Female, 5470-5850 MHz, 10 dBi	PE51039	\$150.58	\$140.04	\$129.50	\$120.46	20
		12 dBi	Vertical Omni Antenna, 750mm X 25mm dia., Fiberglass Radome, N Female, 5470-5850 MHz, 12 dBi	PE51040	\$166.69	\$155.02	\$143.35	\$133.35	21

See Our Website For Real-Time Stock Availability!

Antennas

Free Freight Available via UPS Ground to USA & Canada



Real-Time Stock Levels & Pricing On Our Website



Toil-Free Technical Support (866) 727-8376



Same-Day Shipping, Even Custom Cable Assemblies

# Omni Directional Antennas

## Mobile



Freq. Range (MHz.)	Freq. Band	Gain	Description	Model No	1-24	25-49	50-99	100+	ROW
40 - 47	VHF	0 dbi	Mobile Antenna, Heavy Duty Base, Loaded quarter wave, NMO MOUNT, 40 - 47 MHz, Unity	PE51000	\$44.08	\$40.99	\$37.91	\$35.26	1
118 - 940	VHF, UHF	0 dbi	Mobile Antenna, Field Tunable quarter wave, NMO Mount, 118 - 940 MHz, Unity	PE51001	\$11.75	\$10.93	\$10.11	\$9.40	2
132 - 174	VHF	2.4 db	Wideband Mobile Antenna, 20MHz BW @ 2:1 VSWR, NMO Mount, 132 - 174 MHz, 2.4dB	PE51002	\$54.82	\$50.98	\$47.15	\$43.86	3
			Mobile Base Loaded half wave Antenna, Field Tunable, No GP, NMO Mount, 132 - 174 MHz, 2.4dB	PE51004	\$39.72	\$36.94	\$34.16	\$31.78	4
132 - 512	VHF, UHF	0 dbi	Wideband Mobile Antenna, Field Tunable quarter wave, NMO Mount, 132 - 512 MHz, Unity	PE51003	\$39.72	\$36.94	\$34.16	\$31.78	5
380 - 520	UHF	2 db	Wideband Mobile Antenna, 80MHz BW @ 2:1 VSWR, No GP, NMO Mount, 380 - 520 MHz, 2.0dB	PE51005	\$52.69	\$49.00	\$45.31	\$42.15	6
406 - 512	UHF	2 db	Wideband Mobile Antenna, 106MHz BW @ 2:1 VSWR, No GP, NMO Mount, 406 - 512 MHz, 2.0dB	PE51006	\$65.61	\$61.02	\$56.42	\$52.49	7
440 - 480	UHF	4.5 db	Wideband Mobile Antenna, 40MHz BW @ 2:1 VSWR, No GP, NMO Mount, 440 - 480 MHz, 4.5dB	PE51007	\$58.01	\$53.95	\$49.89	\$46.41	8
474.5-479.5	UHF	5.5 dbi	Colinear Whip Antenna, UHF Male Connector, 474.5-479.5 MHz, 5.5 dBi	PE51060	\$98.95	\$92.02	\$85.10	\$79.16	9
806 - 896	UHF, 800 MHz Cellular	3 db	Mobile Antenna, five-eighths wave over quarter wave, tuned to 835 MHz, 806 - 896 MHz, 3dB	PE51008	\$25.79	\$23.98	\$22.18	\$20.63	10
806 - 960 & 1,710 - 1,990	PCS, iDEN, Cellular	3 dbi	PCS iDEN Cellular Low Profile Antenna, 806 - 960 MHz & 1710 - 1990 MHz, 3dBi	PE51013	\$63.43	\$58.99	\$54.55	\$50.74	11
824 - 960 & 1,850 - 1,990	PCS, Cellular	4 dbi	PCS Cellular Mobile Antenna, Dual Band Collinear, 824 - 896 MHz & 1850 - 1990 MHz, 2.2 dBi   4 dBi	PE51014	\$39.72	\$36.94	\$34.16	\$31.78	12
825 - 896	UHF, 800 MHz Cellular	5 db	Mobile Antenna, Dual half wave over quarter wave, tuned to 835 MHz, 825 - 896 MHz, 5dB	PE51009	\$38.71	\$36.00	\$33.29	\$30.97	13
870 - 950	ISM	5 db	Mobile Antenna, Dual half wave over quarter wave, tuned to 898 MHz, 870 - 950 MHz, 5dB	PE51010	\$38.71	\$36.00	\$33.29	\$30.97	14
880-965/ 1,710-2,170	Dual Band Cellular	3 dbi	Dual Band Magnetic Mount Antenna with 10 foot RG174 Coaxial Cable attached, 880-965 MHz   1710-2170 MHz, 3dBi	PE51113					15
			PE51113 terminated with SMA Female connector, 880-965 MHz   1710-2170 MHz, 3dBi	PE51113-1	\$31.46	\$29.26	\$27.06	\$25.17	16
			PE51113 terminated with N Female connector, 880-965 MHz   1710-2170 MHz, 3dBi	PE51113-2	\$31.46	\$29.26	\$27.06	\$25.17	17
			PE51113 terminated with TNC Male connector, 880-965 MHz   1710-2170 MHz, 3dBi	PE51113-3	\$31.46	\$29.26	\$27.06	\$25.17	18
			PE51113 terminated with SMA Male connector, 880-965 MHz   1710-2170 MHz, 3dBi	PE51113-4	\$31.46	\$29.26	\$27.06	\$25.17	19
2,400-2,500	Wi-Fi, ISM	3 dbi	No Ground Plane Low Profile Vertical Antenna, 2.4-2.5 GHz, 100 MHz, 3dBi	PE51136	\$63.43	\$58.99	\$54.55	\$50.74	20

**In 1973, Dr. Martin Cooper first demonstrated the hand-held mobile phone, which weighed 2.2 lbs.**

# Omni Directional Antennas

## Portable



PE51056



PE51088



PE51117



PE51089-4

Freq. Range (MHz.)	Freq. Band	Gain	Description	Model No	1-24	25-49	50-99	100+	ROW
890-960/ 1,710-1,880	Dual Band Cellular	3 dBi	Magnetic Mount Terminal Antenna with 16 foot RG174 U Coaxial Cable attached , 890-960 MHz   1710-1880 MHz, 3dBi	PE51089					1
			PE51089 terminated with SMA Male connector, 890-960 MHz   1710-1880 MHz, 3dBi	PE51089-1	\$27.11	\$25.21	\$23.31	\$21.69	2
			PE51089 terminated with SMA Female connector, 890-960 MHz   1710-1880 MHz, 3dBi	PE51089-2	\$27.11	\$25.21	\$23.31	\$21.69	3
			PE51089 terminated with N Female connector, 890-960 MHz   1710-1880 MHz, 3dBi	PE51089-3	\$27.11	\$25.21	\$23.31	\$21.69	4
			PE51089 terminated with TNC Male connector, 890-960 MHz   1710-1880 MHz, 3dBi	PE51089-4	\$27.11	\$25.21	\$23.31	\$21.69	5
			PE51089 Terminated with Reverse Polarity SMA Male Connector, 890-960 MHz   1710-1880 MHz, 3dBi	PE51089-5	\$39.72	\$36.94	\$34.16	\$31.78	6
900-960	GSM, ISM	0 dBi	Unity Gain, 1/4 Wave White Radome Antenna, 70mm SMA Male Right Angle, 900-960 MHz, Unity	PE51056	\$24.72	\$22.99	\$21.26	\$19.78	7
1,700-1,850	GSM	3.5 dBi	High Performance Broadband Colinear Vertical Antenna with Spring 12 inches, with Black Radome, N Male, 1700-1850 MHz, 3.5 dBi	PE51119	\$376.39	\$350.04	\$323.70	\$301.11	8
			High Performance Broadband Colinear Vertical Antenna with Spring 11.75 inches, with Black Radome, TNC Male, 1700-1850 MHz, 3.5 dBi	PE51120	\$376.39	\$350.04	\$323.70	\$301.11	9
1,700-2,500	UMTS, ISM, Wi-Fi	2 dBi	High Performance Broadband Colinear Vertical Antenna with Spring 10 inches, with Black Radome, N Male, 1700-2500 MHz, 2 dBi	PE51117	\$376.39	\$350.04	\$323.70	\$301.11	10
			High Performance Broadband Colinear Vertical Antenna with Spring 10 inches, with Black Radome, TNC Male, 1700-2500 MHz, 2 dBi	PE51118	\$337.68	\$314.04	\$290.40	\$270.14	11
1,900-2,500	ISM, Wi-Fi	3.5 dBi	High Performance Broadband Colinear Vertical Antenna with Spring 10 inches, with Black Radome, N Male, 1900-2500 MHz, 3.5 dBi	PE51121	\$376.39	\$350.04	\$323.70	\$301.11	12
			High Performance Broadband Colinear Vertical Antenna with Spring 10 inches, with Black Radome, TNC Male, 1900-2500 MHz, 3.5 dBi	PE51122	\$376.39	\$350.04	\$323.70	\$301.11	13
2,200-2,500	ISM, Wi-Fi	6 dBi	High Performance Broadband Colinear Vertical Antenna with Spring 18 inches, with Black Radome, N Male, 2200-2500 MHz, 6 dBi	PE51123	\$376.39	\$350.04	\$323.70	\$301.11	14
			High Performance Broadband Colinear Vertical Antenna with Spring 18 inches, with Black Radome, TNC Male, 2200-2500 MHz, 6 dBi	PE51124	\$380.04	\$353.44	\$326.83	\$304.03	15
2,400-2,500	Wi-Fi, ISM	3 dBi	Mini Vertical Omni Antenna, Fiberglass Radome, 116mm X 15mm N Male Fixed Right Angle	PE51133	\$145.16	\$135.00	\$124.84	\$116.13	16
2,400-2,500/ 4,900-5,825	Wi-Fi, ISM	2 to 3 dBi	Mini Omni Grey Radome, 90.7mm Dia X 14.5mm, Reverse Polarity TNC Male, 2400-2500 MHz   4900-5825 MHz, 2 & 3 dBi	PE51088	\$24.67	\$22.94	\$21.22	\$19.74	17
3,300-3,800	WIMAX	5 dBi	Magnetic Mount WiMax Antenna with 10 foot RG316 U Coaxial Cable Attached, 3300-3800 MHz, 5 dBi	PE51110					18
			PE51110 terminated with SMA Female, 3300-3800 MHz, 5 dBi	PE51110-1	\$32.48	\$30.21	\$27.93	\$25.98	19
			PE51110 terminated with N Female, 3300-3800 MHz, 5 dBi	PE51110-2	\$32.48	\$30.21	\$27.93	\$25.98	20
			PE51110 terminated with SMA Male, 3300-3800 MHz, 5 dBi	PE51110-3	\$32.48	\$30.21	\$27.93	\$25.98	21
			PE51110 terminated with TNC Male, 3300-3800 MHz, 5 dBi	PE51110-4	\$32.48	\$30.21	\$27.93	\$25.98	22
4,400-5,000	C-Band	6 dBi	High Performance Broadband Vertical Antenna with Spring 11 inches, TNC Male, 4400-5000 MHz, 6 dBi	PE51134	\$425.94	\$396.12	\$366.31	\$340.75	23
			4400-5500MHz, 6 dBi, Broadband High Performance (BHPV) Vertical Antenna W/Spring, 11 Inches, N Male	PE51135	\$425.94	\$396.12	\$366.31	\$340.75	24

See Our Website For Real-Time Stock Availability!

Antennas

Free Freight Available via UPS Ground to USA & Canada



Real-Time Stock Levels & Pricing On Our Website



Toil-Free Technical Support (866) 727-8376



Same-Day Shipping, Even Custom Cable Assemblies

# Omni Directional Antennas

## Portable



PE51125



PE51128

Freq. Range (MHz.)	Freq. Band	Gain	Description	Model No	1-24	25-49	50-99	100+	ROW
5,250-5,850	Wi-Fi, WIMAX	3.8 dBi	High Performance Broadband Colinear Vertical Antenna with Spring 11 inches, with Black Radome, N Male, 5250-5850 MHz, 3.8 dBi	PE51125	\$376.39	\$350.04	\$323.70	\$301.11	1
			High Performance Broadband Vertical Antenna with Spring 11 inches, with Black Radome, TNC Male, 5250-5850 MHz, 3.8 dBi	PE51126	\$376.39	\$350.04	\$323.70	\$301.11	2
		6 dBi	High Performance Broadband Vertical Antenna with Spring 11 inches, with Black Radome, N Male, 5250-5850 MHz, 6 dBi	PE51127	\$376.39	\$350.04	\$323.70	\$301.11	3
			High Performance Broadband Vertical Antenna with Spring 11 inches, with Black Radome, TNC Male, 5250-5850 MHz, 6 dBi	PE51128	\$376.39	\$350.04	\$323.70	\$301.11	4

## Portable (Rubber Duck)



PE51026



PE51055



PE51073



PE51081

Freq. Range (MHz.)	Freq. Band	Gain	Description	Model No	1-24	25-49	50-99	100+	ROW
900-960	900 ISM	3 dBi	Duck Whip Antenna, 196mm, N Male, 900-960 MHz, 3 dBi	PE51055	\$60.19	\$55.98	\$51.76	\$48.15	5
902-928	900 ISM	3 dBi	Rubber Duck Portable Antenna, 185mm, Reverse Polarity SMA Male, 902-928 MHz, 3 dBi	PE51026	\$25.79	\$23.98	\$22.18	\$20.63	6
2,300-2,700	ISM, Wi-Fi	2 dBi	Rubber Duck Antenna, 134mm, Reverse Polarity SMA Male, 2300-2700 MHz, 2 dBi	PE51074	\$20.42	\$18.99	\$17.56	\$16.34	7
			Rubber Duck Antenna, 2300-2700 MHz, 4.5 dBi, SMA Male Connector	PE51086	\$15.15	\$14.09	\$13.03	\$12.12	8
		4.5 dBi	Rubber Duck Antenna, 2300-2700 MHz, 4.5 dBi, Reverse Polarity SMA Male Connector	PE51090	\$15.15	\$14.09	\$13.03	\$12.12	9
2,400-2,483	Wi-Fi, ISM	2 dBi	Rubber Duck Portable Antenna, 114mm, SMA Male, 2400-2483 MHz, 2 dBi	PE51018	\$25.79	\$23.98	\$22.18	\$20.63	10
2,400-2,500	ISM, Wi-Fi	2 dBi	Mini Rubber Duck Antenna, 60mm, SSMB Jack, 2400-2500 MHz, 2 dBi	PE51073	\$21.99	\$20.45	\$18.91	\$17.59	11
		3 dBi	Rubber Duck Antenna, 138mm, Reverse Polarity SMA Male, 2400-2500 MHz, 3 dBi	PE51076	\$20.42	\$18.99	\$17.56	\$16.34	12
		2.2 dBi	Rubber Duck Antenna, 108mm, Reverse Polarity SMA Male, 2400-2500 MHz, 2.2 dBi	PE51077	\$24.67	\$22.94	\$21.22	\$19.74	13
		5.5 dBi	Rubber Duck, 198mm, Reverse Polarity SMA Male, 2400-2500 MHz, 5.5 dBi	PE51078	\$23.61	\$21.96	\$20.30	\$18.89	14
		7 dBi	Rubber Duck, 275mm, Reverse Polarity TNC Male, 2400-2500 MHz, 7 dBi	PE51079	\$23.71	\$22.05	\$20.39	\$18.97	15
2,400-2,480/ 4,900-5,300/ 5,725-5,850	ISM, Wi-Fi	2 dBi	Rubber Duck Tri Band Antenna, 195mm, Reverse Polarity SMA Male, 2400-2480 MHz   4900-5300 MHz   5725-5850 MHz, 2 dBi	PE51095	\$21.43	\$19.93	\$18.43	\$17.14	16
2,400-2,500/ 4,900-5,825	ISM, Wi-Fi	2 dBi	Rubber Duck Dual Band Antenna, 108mm, Reverse Polarity SMA Male, 2400-2500 MHz   4900-5825 MHz, 2 dBi	PE51080	\$17.12	\$15.92	\$14.72	\$13.70	17
		3 dBi	Rubber Duck Dual Band Antenna, 130mm, Reverse Polarity SMA Male, 2400-2500 MHz   4900-5825 MHz, 2   3 dBi	PE51081	\$12.87	\$11.97	\$11.07	\$10.30	18



# Omni Directional Antennas

## Portable (Rubber Duck)



PE51071



PE51072



PE51084

Freq. Range (MHz.)	Freq. Band	Gain	Description	Model No	1-24	25-49	50-99	100+	ROW
2,400-2,500/ 4,900-5,825	ISM, Wi-Fi	2 dBi	Rubber Duck Dual Band Antenna, 138mm, SMA Male, 2400-2500 MHz   4900-5825 MHz, 2 dBi	PE51082	\$12.87	\$11.97	\$11.07	\$10.30	1
			Rubber Duck Dual Band Antenna, 108mm, SMA Male, 2400-2500 MHz   4900-5825 MHz, 2 dBi	PE51083	\$12.87	\$11.97	\$11.07	\$10.30	2
		2.5 dBi	Rubber Duck Dual Band Antenna, 198mm, SMA Male, 2400-2500 MHz   4900-5825 MHz, 2.5 dBi	PE51087	\$15.05	\$14.00	\$12.94	\$12.04	3
2,400-2,483/ 5,150-5,850	Wi-Fi	7 dBi	Rubber Duck Dual Band Antenna, 220mm, Reverse Polarity TNC Male, 2400-2483 MHz   5150-5850 MHz, 7 dBi	PE51071	\$12.87	\$11.97	\$11.07	\$10.30	4
3,300-3,800	WIMAX	2 dBi	Rubber Duck Antenna, 102mm, SMA Male, 3300-3800 MHz, 2 dBi	PE51072	\$17.12	\$15.92	\$14.72	\$13.70	5
			Rubber Duck Antenna, 108mm, SMA Male, 3300-3800 MHz, 2 dBi	PE51084	\$20.42	\$18.99	\$17.56	\$16.34	6
3,400-3,800	WIMAX	5 dBi	Rubber Duck Antenna, 198mm, Reverse Polarity SMA Male, 3400-3800 MHz, 5 dBi	PE51085	\$19.25	\$17.90	\$16.56	\$15.40	7
5,725-5,850	Wi-Fi	5 dBi	Rubber Duck Antenna , 180mm, Reverse Polarity TNC Male Fixed Right Angle, 5100-5900 MHz, 5 dBi	PE51070	\$12.87	\$11.97	\$11.07	\$10.30	8

# Directional Antennas

## Dome, In Ceiling



PE51093



PE51106

Freq. Range (MHz.)	Freq. Band	Gain	Description	Model No	1-24	25-49	50-99	100+	ROW
700-2,500	GSM, ISM, Wi-Fi	3 dBi	Dome in Ceiling Mount Antenna, 167mm dia. X 80mm with 6.5 Inches RG58-P Coaxial Cable attached, 700-2500 MHz, 3 dBi	PE51106					9
			Dome in Ceiling Mount Antenna, 167mm dia. X 80mm; terminated with N Female connector, 700-2500 MHz, 3 dBi	PE51106-1	\$28.12	\$26.15	\$24.18	\$22.50	10
			Dome in Ceiling Mount Antenna, 167mm dia. X 80mm; terminated with SMA Male connector, 700-2500 MHz, 3 dBi	PE51106-2	\$28.12	\$26.15	\$24.18	\$22.50	11
			Dome in Ceiling Mount Antenna, 167mm dia. X 80mm; terminated with SMA Female connector, 700-2500 MHz, 3 dBi	PE51106-3	\$28.12	\$26.15	\$24.18	\$22.50	12
			Dome in Ceiling Mount Antenna, 167mm dia. X 80mm; terminated with TNC Male connector, 700-2500 MHz, 3 dBi	PE51106-4	\$28.12	\$26.15	\$24.18	\$22.50	13
800-960/ 1,710-2,500	GSM, ISM, Wi-Fi	3 dBi	Dome in Ceiling Dual Band Antenna, 184mm Dia. X 105mm, N Female, 800-960 MHz   1710-2500 MHz, 3 dBi	PE51093	\$36.53	\$33.97	\$31.42	\$29.22	14
800-3,000	GSM, UMTS, ISM, Wi-Fi	3 to 6.5 dBi	Omni Dome Antenna, 205mm Dia. X 96mm, N Female, 800-3000 MHz, 3-6.5 dBi	PE51057	\$154.88	\$144.04	\$133.20	\$123.90	15
			Dome in Ceiling Mount Antenna, 220mm sq. X 103mm, N Female, 800-3000 MHz, 3-6.5 dBi	PE51059	\$253.78	\$236.02	\$218.25	\$203.02	16

See Our Website For Real-Time Stock Availability!

Antennas



Free Freight Available  
via UPS Ground  
to USA & Canada



Real-Time Stock  
Levels & Pricing  
On Our WebSite



Toil-Free Technical  
Support  
(866) 727-8376



Same-Day Shipping,  
Even Custom  
Cable Assemblies

# Directional Antennas

## Dome, In Ceiling



PE51058



PE51098

Freq. Range (MHz.)	Freq. Band	Gain	Description	Model No	1-24	25-49	50-99	100+	ROW
800-3,000	GSM, Wi-Fi, ISM	6 to 9 dbi	Dome Directional Antenna, 205mm Dia. X 96mm, N Female, 800-3000 MHz, 6-9 dBi	PE51058	\$243.04	\$226.03	\$209.01	\$194.43	1
800-960/ 1,710-2,500	GSM, ISM, Wi-Fi	3 dbi	Omni Directional Dome in Ceiling Dual Band Antenna, 186mm Dia. X 80mm, N Female, 806-960 MHz   1710-2500 MHz, 3 dBi	PE51096	\$53.70	\$49.94	\$46.18	\$42.96	2
		2 to 5 dbi	Dome in Ceiling Mount Antenna, 170mm dia. X 90mm with 10 Inches RG58 Coaxial Cable attached, 1710-2500 MHz, 2-5 dBi	PE51098					
	PE51098 terminated with SMA Male connector, 1710-2500 MHz, 2-5 dBi		PE51098-1	\$54.16	\$50.37	\$46.58	\$43.33	4	
	PE51098 terminated with SMA Female connector, 1710-2500 MHz, 2-5 dBi		PE51098-2	\$54.16	\$50.37	\$46.58	\$43.33	5	
	PE51098 terminated with N Female connector, 1710-2500 MHz, 2-5 dBi		PE51098-3	\$54.16	\$50.37	\$46.58	\$43.33	6	
	PE51098 terminated with TNC Male connector, 1710-2500 MHz, 2-5 dBi		PE51098-4	\$54.16	\$50.37	\$46.58	\$43.33	7	
	824-960/ 1,710-2,500	GSM, ISM, Wi-Fi	3 dbi	Dome in Ceiling Dual Band Antenna, 170mm Dia. X 90mm, N Female, 824-960 MHz   1710-2500 MHz, 3 dBi	PE51097	\$51.63	\$48.02	\$44.40	\$41.30

## Fixed



PE51129



PE51130



PE51131

Freq. Range (MHz.)	Freq. Band	Gain	Description	Model No	1-24	25-49	50-99	100+	ROW
1,700-2,500	UMTS, ISM, Wi-Fi	9 dbi	High Performance Broadband Panel Antenna with Spring 6.2 X 4.2 inches, with Black Radome, SMA Female, 1700-2500 MHz, 9 dBi	PE51130	\$479.70	\$446.12	\$412.54	\$383.76	9
2,350-2,500	Wi-Fi, ISM	4.2 dbi	Mini Dome Antenna, White Radome, 960mm Dia. X 40.29mm, SMA Female, 2350-2500 MHz, 4.2 dBi	PE51131	\$144.09	\$134.00	\$123.92	\$115.27	10
			Mini Dome Antenna, Grey Radome, 960mm Dia. X 40.29mm, SMA Female, 2350-2500 MHz, 4.2 dBi	PE51132	\$144.09	\$134.00	\$123.92	\$115.27	11
4,400-6,400	WIMAX	9 dbi	High Performance Broadband Panel Antenna, with Black Radome 3.6 X 2.1 inches, SMA Female, 4400-6400 MHz, 9 dBi	PE51129	\$376.39	\$350.04	\$323.70	\$301.11	12

**Jagdish Chandra Bose, known by some as the inventor of  
“wireless telecommunications”,  
constructed one of the first horn antennas in 1897.**

# Directional Antennas

## GPS, Active



PE51067



PE51069

Freq. Range (MHz.)	Freq. Band	Gain	Description	Model No	1-24	25-49	50-99	100+	ROW
1,530-1,580/ 1,220-1,230	L2, L1	56 db	Dual Band Antenna, High Performance L1 & L2 GPS Active Antenna, 139X178mm Dia., N Female, L1: 1530-1580 MHz   L2: 1220-1230 MHz, 56 dB	PE51069	\$1,560.74	\$1,451.49	\$1,342.24	\$1,248.59	1
1,570-1,580	L2	32 dbi	GPS Commercial Active Antenna, 174X132X132mm, N Female, 1570-1580 MHz, 32 dB	PE51067	\$215.12	\$200.06	\$185.00	\$172.10	2
1575	L1	31 db	GPS Antenna, Magnetic Mount, with 15 foot RG174 U Coaxial Cable attached, L1: 1575 MHz, 31 dB	PE51016					3
			PE51016 terminated with SMA Male connector, L1: 1575 MHz, 31 dB	PE51016-1	\$129.09	\$120.05	\$111.02	\$103.27	4
			PE51016 terminated with SMA Female connector, L1: 1575 MHz, 31 dB	PE51016-2	\$129.09	\$120.05	\$111.02	\$103.27	5
			PE51016 terminated with FME Female connector, L1: 1575 MHz, 31 dB	PE51016-3	\$129.09	\$120.05	\$111.02	\$103.27	6
			PE51016 terminated with FME Male connector, L1: 1575 MHz, 31 dB	PE51016-4	\$129.09	\$120.05	\$111.02	\$103.27	7
			PE51016 terminated with MMCX Male connector, L1: 1575 MHz, 31 dB	PE51016-5	\$129.09	\$120.05	\$111.02	\$103.27	8
			PE51016 terminated with MCX Male connector, L1: 1575 MHz, 31 dB	PE51016-6	\$129.09	\$120.05	\$111.02	\$103.27	9
			PE51016 terminated with FAKRA Key Code C connector, L1: 1575 MHz, 31 dB	PE51016-7	\$148.20	\$137.83	\$127.45	\$118.56	10

## GPS, Passive



PE51066

Freq. Range (MHz.)	Freq. Band	Gain	Description	Model No	1-24	25-49	50-99	100+	ROW
1,530-1,580/ 1,220-1,230	L2, L1	6 dBic	Dual Band Antenna, High Performance L1 & L2 GPS Passive Antenna, 139X178mm Dia., N Female, L1: 1530-1580 MHz   L2: 1220-1230 MHz, 6 dBic	PE51068	\$720.66	\$670.21	\$619.77	\$576.53	11
1,572.92- 1,577.92	L2	3 dbi	GPS Passive Antenna, RG174 16 Foot, 43X33X14mm SMA Female, 1572.92-1577.92 MHz, 3 dB	PE51066	\$71.99	\$66.95	\$61.91	\$57.59	12

## Panel



PE51054

Freq. Range (MHz.)	Freq. Band	Gain	Description	Model No	1-24	25-49	50-99	100+	ROW
806-960/ 1,710-2,500	GSM, UMTS, ISM, Wi-Fi	7 dbi	Panel Antenna, Dual Band, 210mm X 180mm X 44mm, N Female, 806-960 MHz   1710-2500 MHz, 7 dBi	PE51054	\$84.91	\$78.97	\$73.02	\$67.93	13

See Our Website For Real-Time Stock Availability!

Antennas



Free Freight Available  
via UPS Ground  
to USA & Canada



Real-Time Stock  
Levels & Pricing  
On Our WebSite



Toll-Free Technical  
Support  
(866) 727-8376



Same-Day Shipping,  
Even Custom  
Cable Assemblies

# Directional Antennas

## Panel



PE51019



PE51025

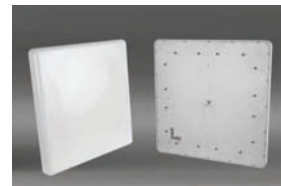

PE51049

Freq. Range (MHz.)	Freq. Band	Gain	Description	Model No	1-24	25-49	50-99	100+	ROW
902-928	900 ISM	9dbi	Outdoor ISM & RFID Vertical Polarization Antenna, 260mm X 260mm X 44mm, N Female, 902-928 MHz, 9 dBi	PE51023	\$172.06	\$160.02	\$147.97	\$137.65	1
		8.5 dbi	Outdoor ISM & RFID Antenna, RHCP, 260mm X 260mm X 44mm, N Female, 902-928 MHz, 8.5 dBi	PE51024	\$172.06	\$160.02	\$147.97	\$137.65	2
			Outdoor ISM & RFID Antenna, LHCP, 260mm X 260mm X 44mm, N Female, 902-928 MHz, 8.5 dBi	PE51025	\$172.06	\$160.02	\$147.97	\$137.65	3
		10.5 dbi	Panel Antenna, 306mm X 306mm X 25mm, N Female, 902-928 MHz, 10.5 dBi	PE51042	\$145.16	\$135.00	\$124.84	\$116.13	4
2,300-2,500	Wi-Fi, ISM	9 dbi	Directional Panel Outdoor Antenna, with 1 foot RG58 Coaxial Cable attached, 127.38mm X 137.16mm X 38.1mm, 2300-2500 MHz, 9 dBi	PE51019					5
			PE51019 terminated with SMA Male connector, 2300-2500 MHz, 9 dBi	PE51019-1	\$63.53	\$59.08	\$54.64	\$50.82	6
			PE51019 terminated with SMA Female connector, 2300-2500 MHz, 9 dBi	PE51019-2	\$63.53	\$59.08	\$54.64	\$50.82	7
			PE51019 terminated with N Male connector, 2300-2500 MHz, 9 dBi	PE51019-3	\$63.53	\$59.08	\$54.64	\$50.82	8
			PE51019 terminated with N Female connector, 2300-2500 MHz, 9 dBi	PE51019-4	\$63.53	\$59.08	\$54.64	\$50.82	9
2,400-2,483	2.4 GHz ISM, Wi Fi	14 dbi	Panel Dual Polarization Antenna, 216mm sq X 82mm, SMA Male, 2400-2483 MHz, 14 dBi	PE51041	\$155.95	\$145.03	\$134.12	\$124.76	10
2,400-2,500	2.4 GHz ISM, Wi Fi	19 dbi	Panel Antenna, 371mm sq. X 40mm, SMA Female, 2400-2500 MHz, 19 dBi	PE51049	\$177.43	\$165.01	\$152.59	\$141.94	11
2,500-2,700	2.4 GHz ISM, Wi Fi	14 dbi	Panel Antenna, 216mm X 216mm X 25mm, N Female, 2500-2700 MHz, 14 dBi	PE51043	\$150.58	\$140.04	\$129.50	\$120.46	12
3,400-3,600	3.5 GHz WiMax	16 dbi	Panel Antenna, 165mm X 165mm X 42mm, N Female, 3400-3600 MHz, 16 dBi	PE51046	\$155.95	\$145.03	\$134.12	\$124.76	13
		18 dbi	Panel Antenna, 268mm X 268mm X 22mm, N Female, 3400-3600 MHz, 18 dBi	PE51047	\$177.43	\$165.01	\$152.59	\$141.94	14
		20 dbi	Panel Antenna, 320mm X 320mm X 25mm, N Female, 3400-3600 MHz, 20 dBi	PE51048	\$198.96	\$185.03	\$171.11	\$159.17	15
5,150-5,850	5 GHz ISM, Wi Fi	23 dbi	Panel Antenna, 320mm X 320mm X 25mm, N Female, 5150-5850 MHz, 23 dBi	PE51044	\$150.58	\$140.04	\$129.50	\$120.46	16
		21 dbi	Panel Antenna, 268mm X 268mm X 25mm, N Female, 5150-5850 MHz, 21 dBi	PE51045	\$145.16	\$135.00	\$124.84	\$116.13	17
	WiMax	23 dbi	Panel Antenna, 306mm X306mm X 25mm, SMA Male, 5150-5850 MHz, 23 dBi	PE51053	\$147.28	\$136.97	\$126.66	\$117.82	18
5,725-5,850	5.7 GHz WiMax	19 dbi	Directional Panel Antenna, 190mm sq. X 30mm, ABS UV Radome, N Female, 5725-5850 MHz, 19 dBi	PE51050	\$193.54	\$179.99	\$166.44	\$154.83	19
		22 dbi	Directional Panel Antenna, 306mm sq. X 20mm, ABS UV Radome, N Female, 5725-5850 MHz, 22 dBi	PE51051	\$215.12	\$200.06	\$185.00	\$172.10	20
			Directional Panel Antenna, 306mm sq. X 20mm, ABS UV Radome, SMA Female, 5725-5850 MHz, 22 dBi	PE51052	\$238.73	\$222.02	\$205.31	\$190.98	21

Navigation satellites broadcast signals in various bands between 1.2 GHz and 1.6 GHz.

# Directional Antennas

## Yagi



PE51011

Freq. Range (MHz.)	Freq. Band	Gain	Description	Model No	1-24	25-49	50-99	100+	ROW
890 - 960	ISM	9 db	YAGI Antenna, 9 dB, Tuned to 930 MHz, N Female, 890 - 960 MHz, 9 dB	PE51011	\$109.64	\$101.97	\$94.29	\$87.71	1
		11 db	YAGI Antenna, 11 dB, Tuned to 930 MHz, N Female, 890 - 960 MHz, 11 dB	PE51012	\$173.17	\$161.05	\$148.93	\$138.54	2

# GAIN HORN ANTENNAS



PE9864/NF-20



PE9862/NF-10



PE9862-15

Freq. Range (MHz.)	Waveguide Size	Interface Type	Gain	Model No	1-24	25-49	50-99	100+	ROW
1,700 - 2,600	WR-430	N Female	10	PE9864/NF-10	\$2,133.71	\$1,984.35	\$1,834.99	\$1,706.97	3
			15	PE9864/NF-15	\$2,636.15	\$2,451.62	\$2,267.09	\$2,108.92	4
			20	PE9864/NF-20	\$3,912.20	\$3,638.35	\$3,364.49	\$3,129.76	5
		SMA Female	10	PE9864/SF-10	\$2,133.71	\$1,984.35	\$1,834.99	\$1,706.97	6
			15	PE9864/SF-15	\$2,636.15	\$2,451.62	\$2,267.09	\$2,108.92	7
			20	PE9864/SF-20	\$3,912.20	\$3,638.35	\$3,364.49	\$3,129.76	8
		Square Flange	10	PE9864-10	\$1,126.74	\$1,047.87	\$969.00	\$901.39	9
			15	PE9864-15	\$1,648.39	\$1,533.00	\$1,417.62	\$1,318.71	10
			20	PE9864-20	\$2,973.53	\$2,765.38	\$2,557.24	\$2,378.82	11
2,600 - 3,950	WR-284	N Female	10	PE9863/NF-10	\$1,587.33	\$1,476.22	\$1,365.10	\$1,269.86	12
			15	PE9863/NF-15	\$1,757.37	\$1,634.35	\$1,511.34	\$1,405.90	13
			20	PE9863/NF-20	\$2,210.92	\$2,056.16	\$1,901.39	\$1,768.74	14
		SMA Female	10	PE9863/SF-10	\$1,587.33	\$1,476.22	\$1,365.10	\$1,269.86	15
			15	PE9863/SF-15	\$1,757.37	\$1,634.35	\$1,511.34	\$1,405.90	16
			20	PE9863/SF-20	\$2,210.92	\$2,056.16	\$1,901.39	\$1,768.74	17
		Square Flange	10	PE9863-10	\$883.09	\$821.27	\$759.46	\$706.47	18
			15	PE9863-15	\$1,059.66	\$985.48	\$911.31	\$847.73	19
			20	PE9863-20	\$1,530.69	\$1,423.54	\$1,316.39	\$1,224.55	20
3,300 - 4,900	WR-229	N Female	10	PE9862/NF-10	\$1,218.80	\$1,133.48	\$1,048.17	\$975.04	21
			15	PE9862/NF-15	\$1,303.76	\$1,212.50	\$1,121.23	\$1,043.01	22
			20	PE9862/NF-20	\$1,615.66	\$1,502.56	\$1,389.47	\$1,292.53	23
		SMA Female	10	PE9862/SF-10	\$1,218.80	\$1,133.48	\$1,048.17	\$975.04	24
			15	PE9862/SF-15	\$1,303.76	\$1,212.50	\$1,121.23	\$1,043.01	25
			20	PE9862/SF-20	\$1,615.66	\$1,502.56	\$1,389.47	\$1,292.53	26
		Square Flange	10	PE9862-10	\$765.29	\$711.72	\$658.15	\$612.23	27
			15	PE9862-15	\$853.60	\$793.85	\$734.10	\$682.88	28
			20	PE9862-20	\$1,177.45	\$1,095.03	\$1,012.61	\$941.96	29
3,950 - 5,850	WR-187	N Female	10	PE9861/NF-10	\$1,303.81	\$1,212.54	\$1,121.28	\$1,043.05	30
			15	PE9861/NF-15	\$1,431.89	\$1,331.66	\$1,231.43	\$1,145.51	31

See Our Website For Real-Time Stock Availability!

Antennas





## Gain Horn Antennas (continued)



PE9860/SF-10



PE9859-15



PE9856/NF-10

Freq. Range (MHz.)	Waveguide Size	Interface Type	Gain	Model No	1-24	25-49	50-99	100+	ROW
3,950 - 5,850	WR-187	N Female	20	PE9861/NF-20	\$1,464.78	\$1,362.25	\$1,259.71	\$1,171.82	1
			10	PE9861/SF-10	\$1,303.81	\$1,212.54	\$1,121.28	\$1,043.05	2
		SMA Female	15	PE9861/SF-15	\$1,431.89	\$1,331.66	\$1,231.43	\$1,145.51	3
			20	PE9861/SF-20	\$1,464.78	\$1,362.25	\$1,259.71	\$1,171.82	4
		Square Flange	10	PE9861-10	\$706.42	\$656.97	\$607.52	\$565.14	5
			15	PE9861-15	\$839.42	\$780.66	\$721.90	\$671.54	6
			20	PE9861-20	\$873.52	\$812.37	\$751.23	\$698.82	7
4,900 - 7,050	WR-159	N Female	10	PE9860/NF-10	\$1,159.27	\$1,078.12	\$996.97	\$927.42	8
			15	PE9860/NF-15	\$1,215.96	\$1,130.84	\$1,045.73	\$972.77	9
			20	PE9860/NF-20	\$1,272.65	\$1,183.56	\$1,094.48	\$1,018.12	10
		SMA Female	10	PE9860/SF-10	\$1,159.27	\$1,078.12	\$996.97	\$927.42	11
			15	PE9860/SF-15	\$1,215.96	\$1,130.84	\$1,045.73	\$972.77	12
			20	PE9860/SF-20	\$1,272.65	\$1,183.56	\$1,094.48	\$1,018.12	13
		Square Flange	10	PE9860-10	\$678.91	\$631.39	\$583.86	\$543.13	14
			15	PE9860-15	\$729.93	\$678.83	\$627.74	\$583.94	15
			20	PE9860-20	\$788.80	\$733.58	\$678.37	\$631.04	16
			20	PE9860-20	\$788.80	\$733.58	\$678.37	\$631.04	16
5,850 - 8,200	WR-137	N Female	10	PE9859/NF-10	\$997.70	\$927.86	\$858.02	\$798.16	17
			15	PE9859/NF-15	\$1,036.91	\$964.33	\$891.74	\$829.53	18
			20	PE9859/NF-20	\$1,077.09	\$1,001.69	\$926.30	\$861.67	19
		SMA Female	10	PE9859/SF-10	\$997.70	\$927.86	\$858.02	\$798.16	20
			15	PE9859/SF-15	\$1,036.91	\$964.33	\$891.74	\$829.53	21
			20	PE9859/SF-20	\$1,077.09	\$1,001.69	\$926.30	\$861.67	22
		Square Flange	10	PE9859-10	\$623.99	\$580.31	\$536.63	\$499.19	23
			15	PE9859-15	\$664.72	\$618.19	\$571.66	\$531.78	24
			20	PE9859-20	\$706.42	\$656.97	\$607.52	\$565.14	25
			20	PE9859-20	\$706.42	\$656.97	\$607.52	\$565.14	25
7,000 - 11,000	WR-102	N Female	10	PE9857/NF-10	\$941.00	\$875.13	\$809.26	\$752.80	26
			15	PE9857/NF-15	\$986.35	\$917.31	\$848.26	\$789.08	27
			20	PE9857/NF-20	\$1,020.34	\$948.92	\$877.49	\$816.27	28
		SMA Female	10	PE9857/SF-10	\$941.00	\$875.13	\$809.26	\$752.80	29
			15	PE9857/SF-15	\$986.35	\$917.31	\$848.26	\$789.08	30
			20	PE9857/SF-20	\$1,020.34	\$948.92	\$877.49	\$816.27	31
		Square Flange	10	PE9857-10	\$623.99	\$580.31	\$536.63	\$499.19	32
			15	PE9857-15	\$671.11	\$624.13	\$577.15	\$536.89	33
			20	PE9857-20	\$706.42	\$656.97	\$607.52	\$565.14	34
			20	PE9857-20	\$706.42	\$656.97	\$607.52	\$565.14	34
7,050 - 10,000	WR-112	N Female	10	PE9858/NF-10	\$884.31	\$822.41	\$760.51	\$707.45	35
			15	PE9858/NF-15	\$929.70	\$864.62	\$799.54	\$743.76	36
			20	PE9858/NF-20	\$963.75	\$896.29	\$828.83	\$771.00	37
		SMA Female	10	PE9858/SF-10	\$884.31	\$822.41	\$760.51	\$707.45	38
			15	PE9858/SF-15	\$929.70	\$864.62	\$799.54	\$743.76	39
			20	PE9858/SF-20	\$963.75	\$896.29	\$828.83	\$771.00	40
		Square Flange	10	PE9858-10	\$623.99	\$580.31	\$536.63	\$499.19	41
			15	PE9858-15	\$671.11	\$624.13	\$577.15	\$536.89	42
			20	PE9858-20	\$706.42	\$656.97	\$607.52	\$565.14	43
			20	PE9858-20	\$706.42	\$656.97	\$607.52	\$565.14	43
8,200 - 12,400	WR-90	N Female	10	PE9856/NF-10	\$850.31	\$790.79	\$731.27	\$680.25	44
			15	PE9856/NF-15	\$884.26	\$822.36	\$760.46	\$707.41	45
			20	PE9856/NF-20	\$918.30	\$854.02	\$789.74	\$734.64	46
		SMA Female	10	PE9856/SF-10	\$850.31	\$790.79	\$731.27	\$680.25	47
			15	PE9856/SF-15	\$884.26	\$822.36	\$760.46	\$707.41	48
			15	PE9856/SF-15	\$884.26	\$822.36	\$760.46	\$707.41	48

# Gain Horn Antennas (continued)

See Our Website For Real-Time Stock Availability!



PE9856-20



PE9854/NF-15



PE9852/2F-15

Freq. Range (MHz.)	Waveguide Size	Interface Type	Gain	Model No	1-24	25-49	50-99	100+	ROW
8,200 - 12,400	WR-90	SMA Female	20	PE9856/SF-20	\$918.30	\$854.02	\$789.74	\$734.64	1
		Square Flange	10	PE9856-10	\$588.68	\$547.47	\$506.26	\$470.94	2
			15	PE9856-15	\$623.99	\$580.31	\$536.63	\$499.19	3
			20	PE9856-20	\$648.31	\$602.93	\$557.55	\$518.65	4
10,000 - 15,000	WR-75	N Female	10	PE9855/NF-10	\$847.22	\$787.91	\$728.61	\$677.78	5
			15	PE9855/NF-15	\$881.27	\$819.58	\$757.89	\$705.02	6
			20	PE9855/NF-20	\$915.31	\$851.24	\$787.17	\$732.25	7
		SMA Female	10	PE9855/SF-10	\$847.22	\$787.91	\$728.61	\$677.78	8
			15	PE9855/SF-15	\$881.27	\$819.58	\$757.89	\$705.02	9
			20	PE9855/SF-20	\$915.31	\$851.24	\$787.17	\$732.25	10
		Square Flange	10	PE9855-10	\$588.68	\$547.47	\$506.26	\$470.94	11
			15	PE9855-15	\$623.99	\$580.31	\$536.63	\$499.19	12
			20	PE9855-20	\$659.35	\$613.20	\$567.04	\$527.48	13
			10	PE9854/NF-10	\$860.04	\$799.84	\$739.63	\$688.03	14
12,400 - 18,000	WR-62	N Female	15	PE9854/NF-15	\$894.09	\$831.50	\$768.92	\$715.27	15
			20	PE9854/NF-20	\$928.08	\$863.11	\$798.15	\$742.46	16
			10	PE9854/SF-10	\$860.04	\$799.84	\$739.63	\$688.03	17
		SMA Female	15	PE9854/SF-15	\$894.09	\$831.50	\$768.92	\$715.27	18
			20	PE9854/SF-20	\$928.08	\$863.11	\$798.15	\$742.46	19
			10	PE9854-10	\$588.68	\$547.47	\$506.26	\$470.94	20
		Square Flange	15	PE9854-15	\$613.55	\$570.60	\$527.65	\$490.84	21
			20	PE9854-20	\$648.31	\$602.93	\$557.55	\$518.65	22
			10	PE9853/SF-10	\$1,088.99	\$1,012.76	\$936.53	\$871.19	23
			15	PE9853/SF-15	\$1,134.34	\$1,054.94	\$975.53	\$907.47	24
15,000 - 22,000	WR-51	SMA Female	20	PE9853/SF-20	\$1,168.33	\$1,086.55	\$1,004.76	\$934.66	25
			10	PE9853-10	\$623.99	\$580.31	\$536.63	\$499.19	26
			15	PE9853-15	\$671.11	\$624.13	\$577.15	\$536.89	27
		Square Flange	20	PE9853-20	\$706.42	\$656.97	\$607.52	\$565.14	28
			10	PE9852/2F-10	\$1,053.33	\$979.60	\$905.86	\$842.66	29
			15	PE9852/2F-15	\$1,098.67	\$1,021.76	\$944.86	\$878.94	30
18,000 - 26,500	WR-42	2.92 mm Female	20	PE9852/2F-20	\$1,132.72	\$1,053.43	\$974.14	\$906.18	31
			10	PE9852-10	\$623.99	\$580.31	\$536.63	\$499.19	32
			15	PE9852-15	\$671.11	\$624.13	\$577.15	\$536.89	33
		Square Flange	20	PE9852-20	\$726.13	\$675.30	\$624.47	\$580.90	34
			10	PE9851/2F-10	\$1,251.88	\$1,164.25	\$1,076.62	\$1,001.50	35
			15	PE9851/2F-15	\$1,297.28	\$1,206.47	\$1,115.66	\$1,037.82	36
22,000 - 33,000	WR-34	2.92 mm Female	20	PE9851/2F-20	\$1,331.32	\$1,238.13	\$1,144.94	\$1,065.06	37
			10	PE9851-10	\$623.99	\$580.31	\$536.63	\$499.19	38
			15	PE9851-15	\$671.11	\$624.13	\$577.15	\$536.89	39
		Square Flange	20	PE9851-20	\$706.42	\$656.97	\$607.52	\$565.14	40
			10	PE9850/2F-10	\$1,251.02	\$1,163.45	\$1,075.88	\$1,000.82	41
			15	PE9850/2F-15	\$1,296.37	\$1,205.62	\$1,114.88	\$1,037.10	42
26,500 - 40,000	WR-28	2.92 mm Female	20	PE9850/2F-20	\$1,330.31	\$1,237.19	\$1,144.07	\$1,064.25	43
			10	PE9850-10	\$623.99	\$580.31	\$536.63	\$499.19	44
			15	PE9850-15	\$671.11	\$624.13	\$577.15	\$536.89	45
		Square Flange	20	PE9850-20	\$706.42	\$656.97	\$607.52	\$565.14	46

Antennas

# Antenna Accessories

## NMO Adapter



PE51021

Freq. Range (MHz.)	Freq. Band	Description	Model No	1-24	25-49	50-99	100+	ROW
0 - 1,000	UHF	NMO Mount; No Cable Or Connector; DC - 1000 MHz	PE51021	\$8.97	\$8.34	\$7.71	\$7.18	1
0 - 5,800	Wi-Fi, ISM	NMO Crimp Mount; For Antennas Over 1 GHz; SMA Connector; DC - 5800 MHz	PE51020	\$31.16	\$28.98	\$26.80	\$24.93	2

## NMO Mount, Magnetic



PE51022-1



PE51022-10



PE51022-13



PE51022-9

Freq. Range (MHz.)	Freq. Band	Description	Model No	1-24	25-49	50-99	100+	ROW
0 - 2,400	Wi-Fi, ISM	NMO Magnetic Mount; With 12 Foot RG58 Coaxial Cable ; DC - 2400 MHz	PE51022					3
		NMO Magnetic Mount; DC - 2400 MHz; With 12 Foot RG58 Coaxial Cable; SMA Male	PE51022-1	\$44.43	\$41.32	\$38.21	\$35.54	4
		NMO Magnetic Mount; DC - 2400 MHz; With 12 Foot RG58 Coaxial Cable; Mini-UHF Male	PE51022-10	\$44.43	\$41.32	\$38.21	\$35.54	5
		NMO Magnetic Mount; DC - 2400 MHz; With 12 Foot RG58 Coaxial Cable; Mini-UHF Female	PE51022-11	\$44.43	\$41.32	\$38.21	\$35.54	6
		NMO Magnetic Mount; DC - 2400 MHz; With 12 Foot RG58 Coaxial Cable; Rev. Polarity SMA Male	PE51022-12	\$44.84	\$41.70	\$38.56	\$35.87	7
		NMO Magnetic Mount; DC - 2400 MHz; With 12 Foot RG58 Coaxial Cable; PI-259 UHF Connector	PE51022-13	\$44.84	\$41.70	\$38.56	\$35.87	8
		NMO Magnetic Mount; DC - 2400 MHz; With 12 Foot RG58 Coaxial Cable; Rev. Polarity TNC Male	PE51022-14	\$59.25	\$55.10	\$50.96	\$47.40	9
		NMO Magnetic Mount; DC - 2400 MHz; With 12 Foot RG58 Coaxial Cable; SMA Female	PE51022-2	\$44.43	\$41.32	\$38.21	\$35.54	10
		NMO Magnetic Mount; DC - 2400 MHz; With 12 Foot RG58 Coaxial Cable; N Male	PE51022-3	\$44.43	\$41.32	\$38.21	\$35.54	11
		NMO Magnetic Mount; DC - 2400 MHz; With 12 Foot RG58 Coaxial Cable; N Female	PE51022-4	\$44.43	\$41.32	\$38.21	\$35.54	12
		NMO Magnetic Mount; DC - 2400 MHz; With 12 Foot RG58 Coaxial Cable; FME Female	PE51022-5	\$44.43	\$41.32	\$38.21	\$35.54	13
		NMO Magnetic Mount; DC - 2400 MHz; With 12 Foot RG58 Coaxial Cable; BNC Male	PE51022-6	\$44.43	\$41.32	\$38.21	\$35.54	14
		NMO Magnetic Mount; DC - 2400 MHz; With 12 Foot RG58 Coaxial Cable; BNC Female	PE51022-7	\$44.43	\$41.32	\$38.21	\$35.54	15
		NMO Magnetic Mount; DC - 2400 MHz; With 12 Foot RG58 Coaxial Cable; TNC Male	PE51022-8	\$44.43	\$41.32	\$38.21	\$35.54	16
	NMO Magnetic Mount; DC - 2400 MHz; With 12 Foot RG58 Coaxial Cable; TNC Female	PE51022-9	\$44.43	\$41.32	\$38.21	\$35.54	17	

See Our Website For Real-Time Stock Availability!

Antennas

ROHS & REACH COMPLIANT. CUSTOM-LENGTH CABLE ASSEMBLIES MAY BE ORDERED ON OUR WEBSITE.

# WAVEGUIDE TO COAX ADAPTERS

## Standard Waveguide Flanges

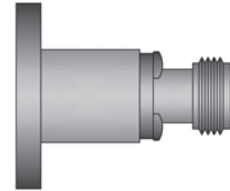

N Female



SMA Male

Frequency Range (MHz.)	Waveguide Size	Connector	Gender	End Launch	Model No	1-24	25-49	50-99	100+	ROW	
1,700 - 2,600	WR-430	SMA	Female		PE9835	\$1,089.04	\$1,012.81	\$936.57	\$871.23	1	
		N		PE9825	\$1,040.96	\$968.09	\$895.23	\$832.77	2		
2,600 - 3,950	WR-284	SMA	Female		PE9834	\$765.29	\$711.72	\$658.15	\$612.23	3	
		N		PE9824	\$647.55	\$602.22	\$556.89	\$518.04	4		
3,300 - 4,900	WR-229	SMA	Female		PE9833	\$500.32	\$465.30	\$430.28	\$400.26	5	
		N		PE9823	\$470.93	\$437.96	\$405.00	\$376.74	6		
3,950 - 5,850	WR-187	SMA	Female		PE9832	\$647.55	\$602.22	\$556.89	\$518.04	7	
		N		PE9822	\$470.93	\$437.96	\$405.00	\$376.74	8		
4,900 - 7,050	WR-159	SMA	Female		PE9831	\$523.88	\$487.21	\$450.54	\$419.10	9	
		N		PE9821	\$569.17	\$529.33	\$489.49	\$455.34	10		
5,850 - 8,200	WR-137	SMA	Female		PE9830	\$405.17	\$376.81	\$348.45	\$324.14	11	
		N		PE9818	\$319.34	\$296.99	\$274.63	\$255.47	12		
7,000 - 11,000	WR-102	SMA	Female		PE9805	\$353.24	\$328.51	\$303.79	\$282.59	13	
				X	PE9849	\$459.13	\$426.99	\$394.85	\$367.30	14	
		N	Female		PE9802	\$353.24	\$328.51	\$303.79	\$282.59	16	
				X	PE9869	\$518.05	\$481.79	\$445.52	\$414.44	17	
		7mm	Sexless		PE9808	\$412.06	\$383.22	\$354.37	\$329.65	18	
				PE9816	\$619.73	\$576.35	\$532.97	\$495.78	19		
7,050 - 10,000	WR-112	SMA	Female		PE9829	\$289.45	\$269.19	\$248.93	\$231.56	20	
				X	PE9865	\$459.13	\$426.99	\$394.85	\$367.30	21	
		N			PE9820	\$280.58	\$260.94	\$241.30	\$224.46	22	
				X	PE9870	\$553.36	\$514.62	\$475.89	\$442.69	23	
		SMA		Female		PE9804	\$286.56	\$266.50	\$246.44	\$229.25	24
					X	PE9848	\$429.64	\$399.57	\$369.49	\$343.71	25
8,200 - 12,400	WR-90	SMA	Male		PE9810	\$329.68	\$306.60	\$283.52	\$263.74	26	
				X	PE9801	\$289.40	\$269.14	\$248.88	\$231.52	27	
		N	Female		PE9868	\$518.05	\$481.79	\$445.52	\$414.44	28	
				X	PE9807	\$353.24	\$328.51	\$303.79	\$282.59	29	
		7mm	Sexless		PE9815	\$619.73	\$576.35	\$532.97	\$495.78	30	
				PE9819	\$286.31	\$266.27	\$246.23	\$229.05	31		
10,000 - 15,000	WR-75	SMA	Female		PE9847	\$478.02	\$444.56	\$411.10	\$382.42	32	
				X	PE9817	\$365.35	\$339.78	\$314.20	\$292.28	33	
		N			PE9867	\$518.05	\$481.79	\$445.52	\$414.44	34	
				X	PE9803	\$296.44	\$275.69	\$254.94	\$237.15	35	
12,400 - 18,000	WR-62	SMA	Female		PE9846	\$493.22	\$458.69	\$424.17	\$394.58	36	
				X	PE9809	\$300.65	\$279.60	\$258.56	\$240.52	37	
		N	Female		PE9800	\$304.65	\$283.32	\$262.00	\$243.72	38	
				X	PE9866	\$541.86	\$503.93	\$466.00	\$433.49	39	
		7mm	Sexless		PE9806	\$354.91	\$330.07	\$305.22	\$283.93	40	
				PE9814	\$619.73	\$576.35	\$532.97	\$495.78	41		
15,000 - 22,000	WR-51	SMA	Female		PE9828	\$498.39	\$463.50	\$428.62	\$398.71	42	
				X	PE9845	\$606.36	\$563.91	\$521.47	\$485.09	43	
				PE9812	\$461.96	\$429.62	\$397.29	\$369.57	44		
18,000 - 26,500	WR-42	SMA	Female		PE9844	\$730.54	\$679.40	\$628.26	\$584.43	45	
		X		PE9813	\$470.93	\$437.96	\$405.00	\$376.74	46		
22,000 - 33,000	WR-34	2.92mm	Female		PE9827	\$676.07	\$628.75	\$581.42	\$540.86	47	
26,500 - 40,000	WR-28	2.92mm	Female		PE9826	\$663.81	\$617.34	\$570.88	\$531.05	48	

See Our Website For Real-Time Stock Availability!

Waveguides



Free Freight Available via UPS Ground to USA & Canada



Real-Time Stock Levels & Pricing On Our WebSite



Toll-Free Technical Support (866) 727-8376



Same-Day Shipping, Even Custom Cable Assemblies

## Grooved Waveguide Flanges

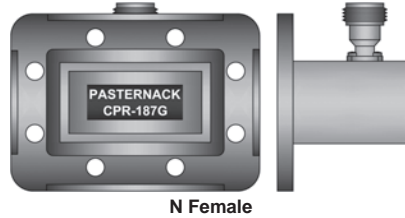

N Female

Frequency Range (MHz.)	Waveguide Size	Connector	Gender	End Launch	Model No	1-24	25-49	50-99	100+	ROW
1,700 - 2,600	CPR-430G	N	Female		PE9843	\$1,177.45	\$1,095.03	\$1,012.61	\$941.96	1
2,600 - 3,950	CPR-284G	N	Female		PE9842	\$765.29	\$711.72	\$658.15	\$612.23	2
3,300 - 4,900	CPR-229G	N	Female		PE9841	\$721.11	\$670.63	\$620.15	\$576.89	3
3,950 - 5,850	CPR-187G	N	Female		PE9840	\$685.55	\$637.56	\$589.57	\$548.44	4
4,900 - 7,050	CPR-159G	N	Female		PE9839	\$588.68	\$547.47	\$506.26	\$470.94	5
5,850 - 8,200	CPR-137G	N	Female		PE9838	\$471.89	\$438.86	\$405.83	\$377.51	6
7,050 - 10,000	CPR-112G	N	Female		PE9837	\$451.53	\$419.92	\$388.32	\$361.22	7
8,200 - 12,400	CPR-90G	N	Female		PE9836	\$382.01	\$355.27	\$328.53	\$305.61	8

## WAVEGUIDE TERMINATIONS

### Precision Terminations

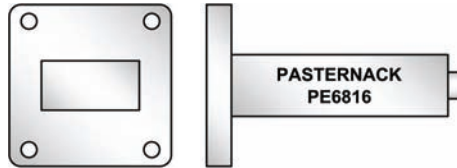

Frequency Range (MHz.)	Waveguide Size	Average Power (Watts Max.)	VSWR (Max.)	Model No	1-24	25-49	50-99	100+	ROW
7,000-11,000	WR-102	2	1.05:1	PE6816	\$588.68	\$547.47	\$506.26	\$470.94	9
7,050-10,000	WR-112			PE6817	\$588.68	\$547.47	\$506.26	\$470.94	10
8,200-12,400	WR-90			PE6815	\$588.68	\$547.47	\$506.26	\$470.94	11
10,000-15,000	WR-75	1.5		PE6814	\$588.68	\$547.47	\$506.26	\$470.94	12
12,400-18,000	WR-62			PE6813	\$622.52	\$578.94	\$535.37	\$498.02	13
15,000-22,000	WR-51	1		PE6812	\$635.90	\$591.39	\$546.87	\$508.72	14
18,000-26,500	WR-42	0.5		PE6811	\$622.52	\$578.94	\$535.37	\$498.02	15
22,000-33,000	WR-34			PE6810	\$622.52	\$578.94	\$535.37	\$498.02	16
26,500-40,000	WR-28			PE6809	\$622.52	\$578.94	\$535.37	\$498.02	17

**In 1893, J.J. Thomson first proposed a structure for guiding electromagnetic waves, later to be called a "waveguide".**



# Waveguide Terminations

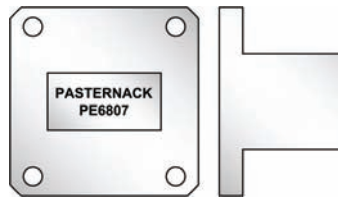

Frequency Range (MHz.)	Waveguide Size	Average Power (Watts Max.)	VSWR (Max.)	Model No	1-24	25-49	50-99	100+	ROW
7,000-11,000	WR-102	2	1.20:1	PE6807	\$353.24	\$328.51	\$303.79	\$282.59	1
7,050-10,000	WR-112			PE6808	\$353.24	\$328.51	\$303.79	\$282.59	2
8,200-12,400	WR-90			PE6806	\$353.24	\$328.51	\$303.79	\$282.59	3
10,000-15,000	WR-75			PE6805	\$353.24	\$328.51	\$303.79	\$282.59	4
12,400-18,000	WR-62	1.5	1.25:1	PE6804	\$294.31	\$273.71	\$253.11	\$235.45	5
15,000-22,000	WR-51	1		PE6803	\$294.31	\$273.71	\$253.11	\$235.45	6
18,000-26,500	WR-42	0.5		PE6802	\$294.31	\$273.71	\$253.11	\$235.45	7
22,000-33,000	WR-34		PE6801	\$200.23	\$186.21	\$172.20	\$160.18	8	
26,500-40,000	WR-28		1.30:1	PE6800	\$200.53	\$186.49	\$172.46	\$160.42	9

# Medium Power Terminations



Frequency Range (MHz.)	Waveguide Size	Average Power (Watts Max.)	VSWR (Max.)	Model No	1-24	25-49	50-99	100+	ROW
7,000-11,000	WR-102	100	1.07:1	PE6825	\$824.22	\$766.52	\$708.83	\$659.38	10
7,050-10,000	WR-112			PE6826	\$824.22	\$766.52	\$708.83	\$659.38	11
8,200-12,400	WR-90	90		PE6824	\$824.22	\$766.52	\$708.83	\$659.38	12
10,000-15,000	WR-75	75		PE6823	\$824.22	\$766.52	\$708.83	\$659.38	13
12,400-18,000	WR-62	60		PE6822	\$706.42	\$656.97	\$607.52	\$565.14	14
15,000-22,000	WR-51	55		PE6821	\$706.42	\$656.97	\$607.52	\$565.14	15
18,000-26,500	WR-42	50		PE6820	\$706.42	\$656.97	\$607.52	\$565.14	16
22,000-33,000	WR-34	40		PE6819	\$706.42	\$656.97	\$607.52	\$565.14	17
26,500-40,000	WR-28			PE6818	\$706.42	\$656.97	\$607.52	\$565.14	18

The microwave "L band" ranges between 1 to 2 GHz, while the "D band" ranges between 110 to 170 GHz.

See Our Website For Real-Time Stock Availability!

Waveguides



# INDEX GUIDE TO FIBER OPTIC PRODUCTS

For the complete selection of our Fiber Optic components and assemblies, please visit the Fiber Optic sections on our website at [www.pasternack.com](http://www.pasternack.com)

## FIBER OPTIC CATEGORIES

### F/O MODE CONDITIONING CABLE ASSEMBLIES



Mode conditioning cable assemblies are mainly used in Gigabit Ethernet (1000 BaseLX) applications where there is a requirement for interconnection of both single mode fiber channels and multimode fiber channels.

### F/O ADAPTERS



Pasternack offers ST, FC & SC, Single Mode, Multimode, Simplex & Duplex Adapters.

### F/O CABLE ASSEMBLIES

Single Mode UPC 8.3/125,  
Single Mode APC 8.3/125,  
Multimode 62.5/125 & 10GB  
Multimode 50/125



### F/O LOOPBACKS

Fiber Optic Loopbacks are designed to provide a return path for a fiber optic signal and is typically used for fiber optic testing applications or network restorations.



### OPTICAL AUDIO CABLE ASSEMBLIES



Optical Audio Cable and digital optical patch cables are used to transmit S/PDIF digital audio information in optical form (red light).

### F/O ATTENUATORS

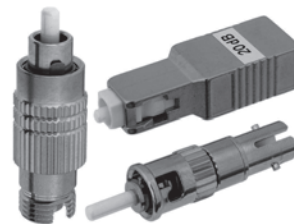

Pasternack Single Mode Fixed Fiber Optic Attenuators offer low return loss, high mode stability and a variety of attenuation values: 5, 10, 15, 20, 25 and 30 dB.

### NOTES:

These Fiber Optic categories are a representation of what you will find on our website. To view our entire Fiber Optic offering, please visit [www.pasternack.com](http://www.pasternack.com).

If you have additional questions regarding our Fiber Optic products, please contact our Technical Service department directly at 1-866-727-8376 or [techsupport@pasternack.com](mailto:techsupport@pasternack.com)



Free Freight Available  
via UPS Ground  
to USA & Canada



Real-Time Stock  
Levels & Pricing  
On Our WebSite



Toll-Free Technical  
Support  
(866) 727-8376



Same-Day Shipping,  
Even Custom  
Cable Assemblies

# INDEX GUIDE TO TOOLS

## INTERCONNECT MISCELLANEOUS.....237

### EMI-RFI GASKET FOR SMA CONNECTORS.....237



Square EMI Gaskets for use with 4 Hole Flange connectors. EMI / RFI Ring Gaskets for use with Field Replaceable Panel Mount connectors.

### HERMETIC SEAL SOLDER CONTACTS.....237



Solder-In Hermetic Feedthru's are available in a range of pin diameters and pin lengths.

### FIELD REPLACEABLE TAB CONTACTS.....237

Tab contacts for use with field replaceable connectors are available in 0.020" and 0.036" pin diameters. The tabs on these contacts are 0.005 inches thick x 0.020 inches wide.



### NOTES:

## TOOLS.....238

### CABLE CUTTER.....238



This heavy duty tool is designed specifically for cutting coaxial cable by hand.

### HARDWARE MISCELLANEOUS.....238



An assortment of screws and nuts are available for use with Pasternack connectors.

### CRIMP TOOL DIES.....240

Pasternack offers Crimp Tool Dies that work with our Crimp Tools allowing a single tool to be used for several crimp sizes.



### INSERTION / EXTRACTION TOOL.....239

Our BNC insertion tool assists in the mating and demating of BNC connectors in tight spaces.



### CRIMP TOOLS.....239



Coaxial Crimp Tools are available for a wide range of coax connectors. These Crimp Tools come in fixed hex sizes or accept interchangeable Hex Dies. There is also a Crimp Tool Kit available.

### TORQUE WRENCHES.....239



Torque Wrenches for popular connector designs set to common torque values. Preset values range from 3 to 14 in-lbs. Hex heads available from 1/4" to 13/16".

# INTERCONNECT MISCELLANEOUS

## Field Replaceable Tab Contacts

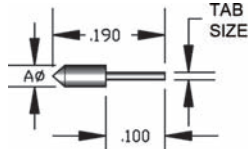

Contact Diameter (A) (in.)	Tab Size (in.)	Model No	1-24 PACKS*	25-49 PACKS*	50-99 PACKS*	100+ PACKS*	ROW
0.020	0.005 x 0.020	PE1002-1	\$2.89	\$2.69	\$2.49	\$2.31	1
0.036	0.005 x 0.020	PE1002-2	\$2.89	\$2.69	\$2.49	\$2.31	2

\* SOLD IN PACKS OF 5 PCS.

## Hermetic Seal Solder Contacts

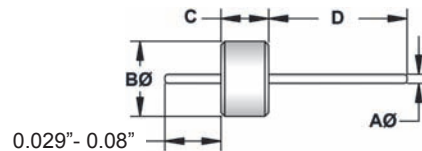

Pin Diameter (A) (in.)	Body Diameter (B) (in.)	Body Length (C) (in.)	Pin Length (D) (in.)	Model No	1-24 PACKS*	25-49 PACKS*	50-99 PACKS*	100+ PACKS*	ROW
0.009	0.068	0.055	0.031	PE1001-7	\$3.90	\$3.63	\$3.35	\$3.12	3
0.012	0.076	0.055	0.041	PE1001-6	\$3.80	\$3.53	\$3.27	\$3.04	4
	0.100	0.063	0.180	PE1001-1	\$3.14	\$2.92	\$2.70	\$2.51	5
0.015	0.100	0.063	0.180	PE1001-2	\$3.39	\$3.15	\$2.92	\$2.71	6
0.018	0.112	0.063	0.180	PE1001-3	\$3.14	\$2.92	\$2.70	\$2.51	7
			0.070	PE1001-4	\$3.45	\$3.21	\$2.97	\$2.76	8
0.020	0.158	0.069	0.229	PE1001-5	\$3.39	\$3.15	\$2.92	\$2.71	9

\* SOLD IN PACKS OF 5 PCS.

## EMI-RFI Ring Gasket For SMA Connectors



Outer Diameter (in.)	Inner Diameter (in.)	Thickness (in.)	Model No	1-24 PACKS*	25-49 PACKS*	50-99 PACKS*	100+ PACKS*	ROW
0.180	0.150	0.038	PE1003-1	\$2.89	\$2.69	\$2.49	\$2.31	10

\* SOLD IN PACKS OF 5 PCS.

In 1973, Mario Cardullo patented the first true device of modern RFID.

See Our Website For Real-Time Stock Availability!

Tools



Free Freight Available  
via UPS Ground  
to USA & Canada



Real-Time Stock  
Levels & Pricing  
On Our WebSite



Toll-Free Technical  
Support  
(866) 727-8376



Same-Day Shipping,  
Even Custom  
Cable Assemblies



# EMI-RFI Flat Gasket For SMA 4 Hole Flange Connectors



Thickness (in.)	Model No	1-24*	25-49*	50-99*	100+*	ROW
0.020	PE1003-2	\$11.04	\$10.27	\$9.49	\$8.83	1

\* SOLD INDIVIDUALLY

## TOOLS

### Hardware Miscellaneous

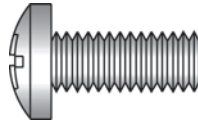

Type	Thread Size (in.)	Screw Head Type	Body Length (in.)	Hex Size (in.)	Construction Material	Model No	1-24 PACKS*	25-49 PACKS*	ROW
SCREWS	3-56	Phillips	0.250	0.187	Stainless Steel	PE1004-1	\$23.51	\$21.86	2
			0.375			PE1004-2	\$23.51	\$21.86	
			0.500			PE1004-3	\$23.51	\$21.86	
	4-40		0.250			PE1005-1	\$23.51	\$21.86	3
			0.375			PE1005-2	\$23.51	\$21.86	
			0.500			PE1005-3	\$23.51	\$21.86	
			0.250		PE1006-1	\$23.51	\$21.86	4	
			0.375		PE1006-2	\$23.51	\$21.86		
			0.500		PE1006-3	\$23.51	\$21.86		
NUTS	3-56	0.187	0.250	Stainless Steel	PE1007	\$14.69	\$13.66	5	
	4-40			Zinc Plated	PE1008	\$14.69	\$13.66	6	
				Zinc Plated	PE1009	\$13.43	\$12.49	7	

\* SOLD IN PACKS OF 100 PCS.

### Cable Cutter



Type	Coax/Wire Type	Model No	1-24	25-49	50-99	100+	ROW
Cable Cutter	Coax	PE5200	\$69.41	\$64.55	\$59.69	\$55.53	8

## Insertion/Extraction Tool



Type	Connector Type	Model No	1-24	25-49	50-99	100+	ROW
Insertion/Extraction Tool	BNC	PE5014	\$42.96	\$39.95	\$36.95	\$34.37	1

## Torque Wrenches



Type	Bit Hex Size (in.)	Preset Torque (in.-lbs.)	Model No	1-24	25-49	50-99	100+	ROW
SMC	1/4	3	PE5011-2	\$235.44	\$218.96	\$202.48	\$188.35	2
SSMA	1/4	8	PE5011-5	\$235.44	\$218.96	\$202.48	\$188.35	3
SMA/2.92mm/3.5mm	5/16	8	PE5011-1	\$166.08	\$154.45	\$142.83	\$132.86	4
TNC	5/8	14	PE5011-4	\$235.44	\$218.96	\$202.48	\$188.35	5
7 mm	3/4	14	PE5011-3	\$262.80	\$244.40	\$226.01	\$210.24	6
N	20mm	14	PE5011-7	\$224.75	\$209.02	\$193.29	\$179.80	7
N/SC	13/16	14	PE5011-6	\$255.60	\$237.71	\$219.82	\$204.48	8

## Crimp Tools

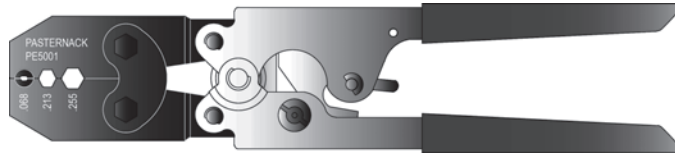

Type	Hex Size (in.)	Compatible Dies	Cable Type	Model No	1-24	25-49	50-99	100+	ROW
Crimp Tools	0.068, 0.100, 0.128, 0.178		RG174, RG179, RG180, RG187, RG188, RG195, RG316	PE5006	\$125.46	\$116.68	\$107.90	\$100.37	9
	0.068, 0.213, 0.255		RG55, RG58, RG59, RG62, RG142, RG223 RG400	PE5001	\$110.41	\$102.68	\$94.95	\$88.33	10
	0.100, 0.429		RG9, RG11, RG87A, RG149, RG165, RG213, RG214, RG216, RG225, RG393	PE5007	\$119.74	\$111.36	\$102.98	\$95.79	11
Crimp Tool Kit	0.042, 0.068, 0.080, 0.100, 0.128, 0.151, 0.178, 0.213, 0.255, 0.324, 0.429		RG5, RG6, RG8, RG9, RG11, RG21, RG55, RG58, RG59, RG62, RG87A, RG140, RG141, RG142, RG143, RG165, RG174, RG179, RG180, RG187, RG188, RG195, RG210, RG212, RG213, RG214, RG216, RG222, RG223, RG225, RG303, RG304, RG316, RG393, RG400	PE5004-KIT	\$283.47	\$263.63	\$243.78	\$226.78	12

## Crimp Tools



Type	Hex Size (in.)	Compatible Dies	Cable Type	Model No	1-24	25-49	50-99	100+	ROW
Crimp Tool, Scissor style, No Die		PE5010-1, PE5010-2, PE5010-3, PE5010-4, PE5010-5 and PE5010-6		PE5008	\$117.69	\$109.45	\$101.21	\$94.15	1
Crimp Tool, Straight Style, No Die		PE5010-1, PE5010-2, PE5010-3, PE5010-4, PE5010-5 and PE5010-6		PE5009	\$147.18	\$136.88	\$126.57	\$117.74	2
Crimp Tool for Compression Connectors			RG6, RG11, RG59	PE5012	\$112.58	\$104.70	\$96.82	\$90.06	3

## Crimp Tool Dies

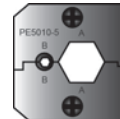
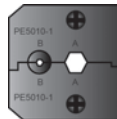
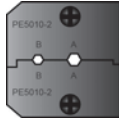

Type	Hex Size (in.)	Compatible Crimp Tools	Cable Type	Model No	1-24	25-49	50-99	100+	ROW
Dies, Crimp Tool	0.128, 0.100	PE5008 and PE5009	RG174, RG178, RG179, RG188, RG196, RG316	PE5010-2	\$93.02	\$86.51	\$80.00	\$74.42	4
	0.213, 0.068		RG58, RG142, RG223, RG400	PE5010-1	\$93.02	\$86.51	\$80.00	\$74.42	5
	0.255, 0.068		RG8X, RG59, RG62, PE-C240	PE5010-3	\$93.02	\$86.51	\$80.00	\$74.42	6
	0.429, 0.100		RG8, RG213, RG214, PE-B400, PE-B405, PE-C400	PE5010-5	\$93.02	\$86.51	\$80.00	\$74.42	7

## Notes

---



---



---



---

# INDEX GUIDE TO APPENDIX

<b>APPENDIX.....</b>	<b>242</b>
<i>BINDING TERMS.....</i>	<i>250</i>
<i>CONNECTOR IDENTIFIER.....</i>	<i>242</i>
<i>GLOSSARY OF RF TERMS.....</i>	<i>251</i>
<i>MAILING LIST CHANGES.....</i>	<i>249</i>
<i>MOUNTING HOLES.....</i>	<i>246</i>
<i>PASTERNAK REACH PROGRAM.....</i>	<i>247</i>
<i>PASTERNAK RoHS PROGRAM.....</i>	<i>248</i>
<i>PE PART # INDEX.....</i>	<i>253</i>

# CONNECTOR IDENTIFIER

SPECIFICATIONS SHOWN ARE INTENDED FOR IDENTIFICATION PURPOSES ONLY

<b>1.0/2.3 SLIDE ON</b>	<b>PLUG</b>		<b>1.0/2.3 SNAP ON</b>	<b>PLUG</b>		<b>1.6/5.6</b>	<b>PLUG</b>	
	<b>JACK</b>			<b>JACK</b>			<b>JACK</b>	
<b>1.85 mm**</b>	<b>MALE</b>		<b>2.4 mm**</b>	<b>MALE</b>		<b>2.92 mm*</b>	<b>MALE</b>	
	<b>FEMALE</b>			<b>FEMALE</b>			<b>FEMALE</b>	
<b>3.5 mm*</b>	<b>MALE</b>		<b>7 mm</b>		<b>7/16</b>	<b>PLUG</b>		
	<b>FEMALE</b>					<b>JACK</b>		
<b>3/4-20 TWINAX</b>	<b>MALE</b>		<b>10-32</b>	<b>MALE</b>		<b>BANANA</b>	<b>PLUG</b>	
	<b>FEMALE</b>			<b>FEMALE</b>			<b>JACK</b>	
<b>BNC</b>	<b>MALE</b>		<b>REVERSE POLARITY BNC</b>	<b>MALE</b>		<b>75 OHM BNC</b>	<b>MALE</b>	
	<b>FEMALE</b>			<b>FEMALE</b>			<b>FEMALE</b>	

\*SMA, 2.92mm, & 3.5mm CONNECTORS WILL MATE MECHANICALLY & ELECTRICALLY TO EACH OTHER.











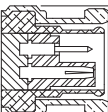
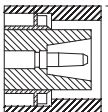
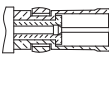
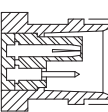
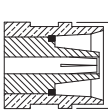
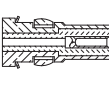
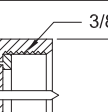
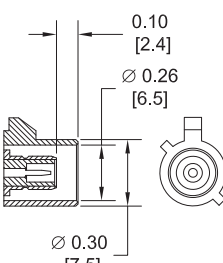
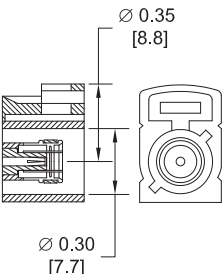
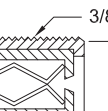

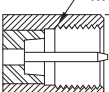









\*\*1.85mm & 2.4mm CONNECTORS WILL MATE MECHANICALLY & ELECTRICALLY TO EACH OTHER.

ROHS & REACH COMPLIANT. CUSTOM-LENGTH CABLE ASSEMBLIES MAY BE ORDERED ON OUR WEBSITE.

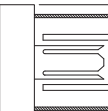
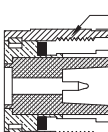
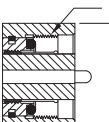

# CONNECTOR IDENTIFIER

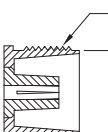
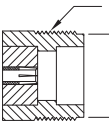
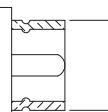
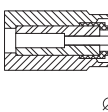
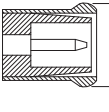
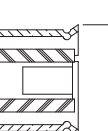

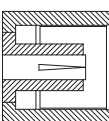

SPECIFICATIONS SHOWN ARE INTENDED FOR IDENTIFICATION PURPOSES ONLY

<b>BNC TWINAX</b>	<b>PLUG</b>	 Ø 0.57" [14.5mm]	<b>C</b>	<b>MALE</b>	 Ø 0.75" [19.1mm]	<b>D SUBMINIATURE</b>	<b>PLUG</b>	 Ø 0.19" [4.8mm]		
	<b>JACK</b>	 Ø 0.44" [11.1mm]		<b>FEMALE</b>	 Ø 0.60" [15.2mm]		<b>RECEPTACLE</b>	 Ø 0.15" [3.9mm]		
<b>F</b>	<b>MALE</b>	 3/8-32 7/16 HEX	<b>FAKRA</b>	<b>PLUG</b>	 0.10 [2.4] Ø 0.26 [6.5] Ø 0.30 [7.5]	<b>FAKRA</b>	<b>JACK</b>	 Ø 0.35 [8.8] Ø 0.30 [7.7]		
	<b>FEMALE</b>	 3/8-32 Ø 0.34 [8.5]		<b>COMPLETE KEY CODE INFO</b>	<b>PLUG</b>		 Ø 0.37 [9.5]	<b>PLUG</b>	 M8 X P.75 Ø 0.37 [9.5]	
<b>FAKRA</b>	<b>CODE</b>	<b>JACK</b>	<b>PLUG</b>	<b>COLOR</b>	<b>APPLICATION</b>	<b>CODE</b>	<b>JACK</b>	<b>PLUG</b>	<b>COLOR</b>	<b>APPLICATION</b>
	<b>A</b>			BLACK	RADIO WITH PHANTOM SUPPLY	<b>H</b>			VIOLET	GPS: TELEMATICS AND NAVIGATION
	<b>B</b>			WHITE	RADIO WITHOUT PHANTOM SUPPLY	<b>I</b>			BEIGE	BLUETOOTH
	<b>C</b>			BLUE	GPS: TELEMATICS OR NAVIGATION	<b>K</b>			CURRY	RADIO WITH I.F. OUTPUT (ANTENNA DIVERSITY)
<b>D</b>			BORDEAUX	GSM: CELLULAR PHONE	<b>Z</b>			WATER BLUE	NEUTRAL CODING	
<b>GR874</b>	<b>MALE</b>	 Ø 0.81 [20.6]	<b>HN</b>	<b>MALE</b>	 3/4-20 Ø 0.90 [22.9]	<b>LC</b>	<b>MALE</b>	 1-1/4-18 1-1/2 HEX		
	<b>FEMALE</b>	 Ø 0.67 [17.1]		<b>FEMALE</b>	 3/4-20 Ø 0.67 [17.1]		<b>FEMALE</b>	 1-1/4-18 Ø 1.17 [29.6]		
<b>UMCX</b>	<b>PLUG</b>	 Ø 0.08 [2.0]	<b>MC-CARD</b>	<b>PLUG</b>	 Ø 0.087 [2.2]	<b>MCX</b>	<b>PLUG</b>	 Ø 0.15 [3.7]		
	<b>JACK</b>	 Ø 0.10 [2.5]		<b>JACK</b>	 Ø 0.20 [5.0]		<b>JACK</b>	 Ø 0.20 [5.0]		



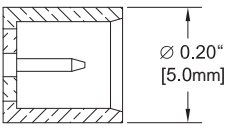
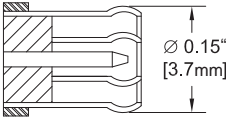
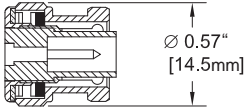
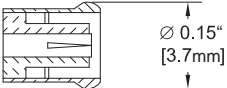
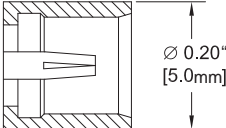

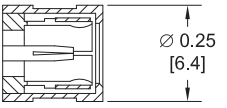
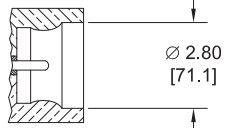
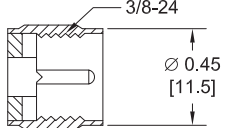
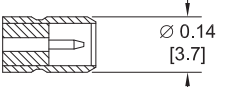
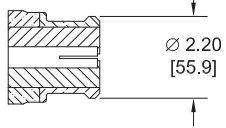
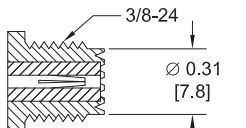
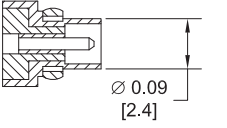
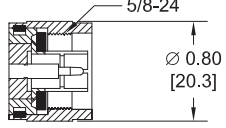
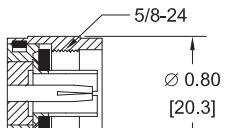
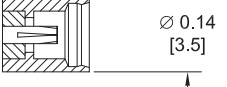
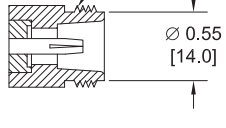
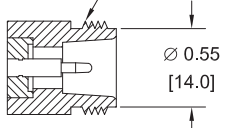
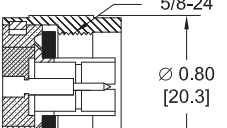
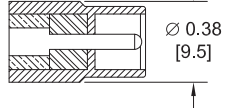
# CONNECTOR IDENTIFIER

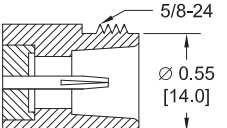
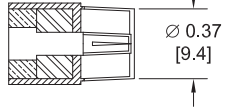
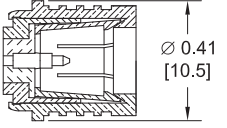
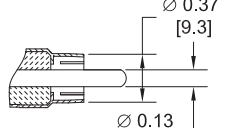
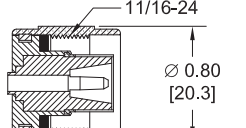
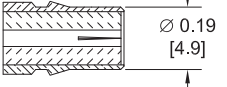
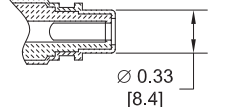
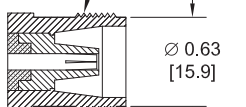
SPECIFICATIONS SHOWN ARE INTENDED FOR IDENTIFICATION PURPOSES ONLY

<b>REVERSE POLARITY MCX</b>	<b>PLUG</b>	 Ø 0.20" [5.0mm]	<b>75 OHM MCX</b>	<b>PLUG</b>	 Ø 0.15" [3.7mm]	<b>MHV</b>	<b>MALE</b>	 Ø 0.57" [14.5mm]
	<b>JACK</b>	 Ø 0.15" [3.7mm]		<b>JACK</b>	 Ø 0.20" [5.0mm]		<b>FEMALE</b>	 Ø 0.44" [11.1mm]
<b>MINI 75 OHM SMB</b>	<b>PLUG</b>	 Ø 0.25 [6.4]	<b>MINI SMP</b>	<b>MALE</b>	 Ø 2.80 [71.1]	<b>MINI-UHF</b>	<b>MALE</b>	 3/8-24 Ø 0.45 [11.5]
	<b>JACK</b>	 Ø 0.14 [3.7]		<b>FEMALE</b>	 Ø 2.20 [55.9]		<b>FEMALE</b>	 3/8-24 Ø 0.31 [7.8]
<b>MMCX</b>	<b>PLUG</b>	 Ø 0.09 [2.4]	<b>N</b>	<b>MALE</b>	 5/8-24 Ø 0.80 [20.3]	<b>REVERSE POLARITY N</b>	<b>MALE</b>	 5/8-24 Ø 0.80 [20.3]
	<b>JACK</b>	 Ø 0.14 [3.5]		<b>FEMALE</b>	 5/8-24 Ø 0.55 [14.0]		<b>FEMALE</b>	 5/8-24 Ø 0.55 [14.0]
<b>75 OHM N</b>	<b>MALE</b>	 5/8-24 Ø 0.80 [20.3]	<b>PAL</b>	<b>PLUG</b>	 Ø 0.38 [9.5]	<b>POSITIVE SNAP</b>		 Ø 0.39 [9.9]
	<b>FEMALE</b>	 5/8-24 Ø 0.55 [14.0]		<b>JACK</b>	 Ø 0.37 [9.4]			
<b>OMA</b>	<b>MALE</b>	 Ø 0.41 [10.5]	<b>RCA</b>	<b>PLUG</b>	 Ø 0.37 [9.3] Ø 0.13 [3.2]	<b>SC</b>	<b>MALE</b>	 11/16-24 Ø 0.80 [20.3]
	<b>FEMALE</b>	 Ø 0.19 [4.9]		<b>JACK</b>	 Ø 0.33 [8.4]		<b>FEMALE</b>	 11/16-24 Ø 0.63 [15.9]

# CONNECTOR IDENTIFIER

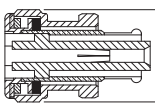
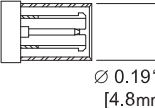
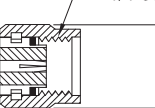
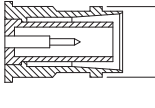
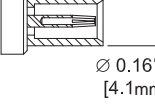
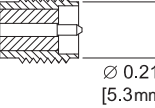
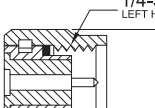
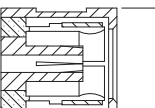
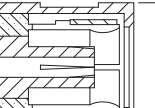
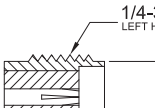
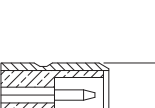
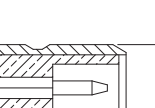
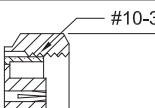
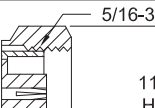
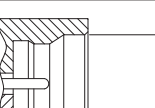
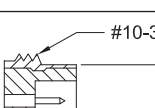
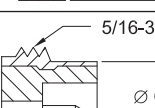
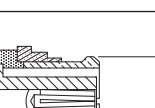
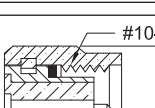
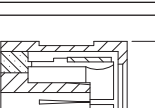
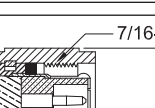
SPECIFICATIONS SHOWN ARE INTENDED FOR IDENTIFICATION PURPOSES ONLY

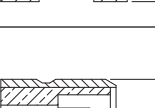
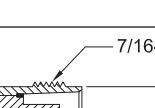
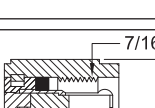
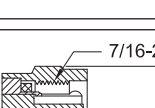
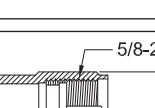
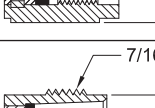
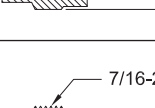
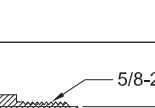
<b>SHV</b>	<b>PLUG</b>	 Ø 0.57" [14.5mm]	<b>SMA*</b>	<b>MALE</b>	 Ø 0.19" [4.8mm]	<b>REVERSE POLARITY SMA</b>	<b>MALE</b>	 1/4-36 5/16 HEX
	<b>JACK</b>	 Ø 0.44" [11.1mm]		<b>FEMALE</b>	 Ø 0.16" [4.1mm]		<b>FEMALE</b>	 1/4-36 Ø 0.21" [5.3mm]
<b>SMA REVERSE THREAD</b>	<b>MALE</b>	 1/4-36 LEFT HAND THREAD 5/16 HEX	<b>SMB</b>	<b>PLUG</b>	 Ø 0.25 [6.4]	<b>75 OHM SMB</b>	<b>PLUG</b>	 Ø 0.37 [9.2]
	<b>FEMALE</b>	 1/4-36 LEFT HAND THREAD Ø 0.21 [5.3]		<b>JACK</b>	 Ø 0.14 [3.7]		<b>JACK</b>	 Ø 0.24 [6.2]
<b>SMC</b>	<b>PLUG</b>	 #10-32 1/4 HEX	<b>75 OHM SMC</b>	<b>PLUG</b>	 5/16-32 11/32 HEX	<b>SMP</b>	<b>MALE</b>	 Ø 3.68 [93.5]
	<b>JACK</b>	 #10-32 Ø 0.14 [3.7]		<b>JACK</b>	 5/16-32 Ø 0.24 [6.2]		<b>FEMALE</b>	 Ø 3.34 [84.8]
<b>SSMA</b>	<b>MALE</b>	 #10-36 1/4 HEX	<b>SSMB</b>	<b>PLUG</b>	 Ø 0.18 [4.7]	<b>TNC</b>	<b>MALE</b>	 7/16-28 Ø 0.59 [15.0]
	<b>FEMALE</b>	 #10-36 Ø 0.16 [4.1]		<b>JACK</b>	 Ø 0.10 [2.6]		<b>FEMALE</b>	 7/16-28 Ø 0.38 [9.6]
<b>75 OHM TNC</b>	<b>MALE</b>	 7/16-28 Ø 0.59 [15.0]	<b>REVERSE POLARITY TNC</b>	<b>MALE</b>	 7/16-28 Ø 0.59 [15.0]	<b>UHF</b>	<b>MALE</b>	 5/8-24 Ø 0.70 [17.8]
	<b>FEMALE</b>	 7/16-28 Ø 0.38 [9.6]		<b>FEMALE</b>	 7/16-28 Ø 0.38 [9.6]		<b>FEMALE</b>	 5/8-24 Ø 0.55 [14.0]

\*SMA, 2.92mm & 3.5mm CONNECTORS WILL MATE MECHANICALLY & ELECTRICALLY TO EACH OTHER.



Free Freight Available  
via UPS Ground  
to USA & Canada



Real-Time Stock  
Levels & Pricing  
On Our WebSite



Toil-Free Technical  
Support  
(866) 727-8376



Same-Day Shipping,  
Even Custom  
Cable Assemblies

# MOUNTING HOLES

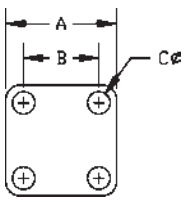

CODE	A	B	C
A01	.500	.340	.102
A02	.687	.500	.109
A03	.687	.500	#3-56 TAP
A04	.687	.500	.125
A05	1.000	.718	.125
A06	.750	.531	.140
A07	.750	.531	.125
A08	1.190	.906	.125
A09	.687	.500	#4-40 TAP
A10	.687	.500	.136
A11	1.250	.975	.147
A12	2.000	1.440	.257
A13	1.000	.718	.141
A14	1.000	.718	.144
A15	.687	.500	.104
A16	.750	.531	.136
A17	.375	.232	.067
A18	.625	.437	.094
A19	1.000	.718	#6-32 TAP
A20	.500	.340	#2-56 TAP
A21	1.250	.975	.142
A22	.375	.232	.093

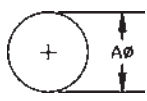

CODE	A
F01	.250
F02	.500
F03	.630
F04	1.200
F05	.380
F06	.450
F07	.200
F08	.362
F09	.220
F10	.317
F11	4.83mm
F12	.390

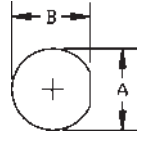

CODE	A	B
B01	.195	.177
B02	.250	.235
B03	.330	.295
B04	.380	.350
B05	.440	.410
B06	.512	.480
B07	.760	.720
B08	.565	.537
B09	.314	.296
B10	.140	.126
B11	.695	.655
B12	.625	.575
B13	.405	.361
B14	.277	.252
B15	.630	.596
B16	.317	.285
B17	.284	.268

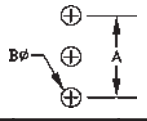

CODE	A	B
J01	.200	.046

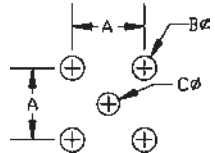

CODE	A	B	C
D01	.200	.067	.062
D02	.200	.067	.046
D03	.100	.031	.031
D04	.200	.052	.052
D05	.260	.067	.043
D06	.200	.052	.047
D07	.200	.055	.043
D08	.200	.067	.035
D09	.200	.055	.028
D10	.200	.055	.035
D11	.320	.091	.031
D12	.400	.062	.062
D13	.320	.091	.091
D14	.340	.091	.043
D15	.164	.067	.091
D16	.500	.126	.440
D17	.380	.083	.043

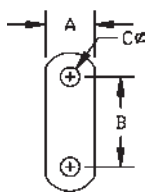

CODE	A	B	C
C01	.223	.481	.102
C02	.260	.481	.102
C03	.192	.328	.067
C04	.640	1.000	.125
C05	.275	.481	.102
C06	.230	.354	.067
C07	.188	.328	.093

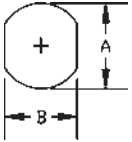

CODE	A	B
G01	.640	.546
G02	.380	.340
G03	.765	.712
G04	.362	.323
G05	.236	.197
G06	.217	.177
G07	.380	.310
G08	1.161	1.000

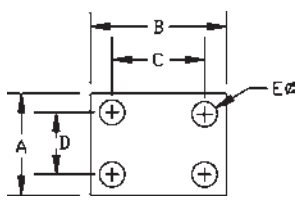

CODE	A	B	C	D	E
E01	.375	.500	.340	.222	.093

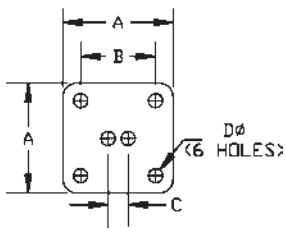

CODE	A	B	C	D
H01	.687	.500	.125	.045

# PASTERNAK ENTERPRISES -- REACH PRODUCT COMPLIANCE PROGRAM

## What is REACH Compliance?

Regulation (EC) No. 1907/2006 of the European Parliament and of the Council of 18 December 2006 is commonly referred to as REACH (Registration, Evaluation, Authorization, and Restriction of Chemicals). The REACH regulation became effective on June 1, 2007 to streamline and improve the former legislative framework for chemicals available in the European Union (EU) and European Economic Area (EEA) countries.

The objective of REACH is to improve protection of human health and the protection of the environment from the exposure to chemicals. REACH compliance is mandatory for products manufactured in, or imported into the European Union (EU).

As outlined by the REACH regulation, any organization manufacturing, importing, using or placing a substance, mixture, article or product on the EU market will be responsible for ensuring that the component substances are in compliance with REACH regulations.

## Determining REACH Compliance of Pasternack Products:

Pasternack Enterprises does not currently either manufacture or import any chemical substances into the EU on their own or in articles (products) in quantities of 1 ton or more per year. In addition, products imported by Pasternack Enterprises' customers do not contain chemical substances intended to be released during the normal and reasonably foreseeable conditions of the product's use as defined by the REACH regulation and existing guidance.

However, under REACH, there is an obligation to ensure that articles do not contain <0.1% by weight of Substances of Very High Concern (SVHCs). SVHCs are substances that may cause cancer or other serious health or environmental effects and thus face restriction or outright bans, and are listed in a regularly-updated 'Candidate list'. The current Candidate list can be downloaded from the European Chemicals Agency (ECHA) website:

[http://echa.europa.eu/chem\\_data/authorisation\\_process/candidate\\_list\\_table\\_en.asp](http://echa.europa.eu/chem_data/authorisation_process/candidate_list_table_en.asp)



For each part that has been found to comply with the REACH SVHC reporting requirements, we show an indication of compliance adjacent to the part number using this symbol:

All products displaying this symbol on our website are assured to contain no SVHCs as defined by the Candidate List displayed on the Pasternack REACH certificate. When you locate the product you need on our website, please click on the "Product ID or Part Number". You will see the "REACH symbol" for the specific part. Click on this symbol to view the Certificate of REACH Compliance (printable if needed) for the specific product as well as the applicable ECHA SVHC Candidate list Date.

## Pasternack Enterprises - REACH Product Compliance Program:

At Pasternack Enterprises, we recognize our responsibility as a worldwide supplier of RF, Microwave and Fiber Optic Products subject to the REACH regulations. We have completed a comprehensive effort internally and with our supply chain to determine the REACH compliance of our products. You will find our Reach Symbol adjacent to all products on our website that have been determined by Pasternack and our supply chain to contain less than 0.1% by weight of the REACH substances. You will also see the applicable ECHA SVHC Candidate List Date. "Please refer to our website at [www.Pasternack.com](http://www.Pasternack.com).

The Pasternack Enterprises REACH Product Compliance Program is implemented in accordance with Regulation No. 1907/2006 of the European Parliament and the Council of 18 December 2006. Pasternack has implemented a REACH compliance program to address this legislation. Pasternack Enterprises does not currently either manufacture or import any chemical substances into the EU on their own or in articles (products) in quantities of 1 ton or more per year. In addition, products imported by Pasternack Enterprises' customers do not contain chemical substances intended to be released during the normal and reasonably foreseeable conditions of the product's use as defined by the REACH regulation and existing guidance. Thus, Pasternack Enterprises does not currently have a direct REACH obligation to pre-register substances. Pasternack's REACH Product Compliance is determined by a certification from our supply chain. A Pasternack product is deemed to be REACH compliant when it does not contain Substances of Very High Concern (SVHCs) beyond the specified concentration limits of less than 0.1% by weight as outlined in REACH 1907/2006/EU regulation.

## Need More Information?

If you have questions regarding REACH Product Certification on Pasternack's products, please contact the Pasternack REACH Compliance Team via email at [REACH@Pasternack.com](mailto:REACH@Pasternack.com) or by calling Toll-Free within North America at 1-866-PASTERNAK (1-866-727-8376). International customers, please call +1-949-261-1920.



# PASTERNAK ENTERPRISES RoHS COMPLIANCE PROGRAM

Lead-free solder is now available for all cable assemblies upon request or online at [www.Pasternack.com](http://www.Pasternack.com).

## What is RoHS Compliance?

The European Union set forth the RoHS (Restriction of Hazardous Substances) Directive to establish environmental guidelines and legislation to reduce the presence of six (6) materials deemed hazardous to the environment. To comply, products entering the EU must not have a homogeneous presence of these materials above the following levels by weight percentage:

- Lead (Pb) < 0.1%
- Mercury (Hg) < 0.1%
- Cadmium (Cd) < 0.01%
- Hexavalent Chromium (CrVI) < 0.1%
- Polybrominated Biphenyls (PBB) < 0.1%
- Polybrominated Diphenyl Esters (PBDE) < 0.1%

At Pasternack, we recognize our responsibility as a supplier of coax connectors, cable assemblies, and components used within electronic-based systems and products that are targeted for RoHS compliance. We are fully committed to offering RoHS compliance on the majority of our products. We have completed a comprehensive evaluation and analysis program both internally and with our suppliers to establish and publish RoHS compliant statements for our products on our website.

## Determining Pasternack RoHS Compliance

To determine if the product in our catalog is RoHS Compliant, please first refer to our website at [www.Pasternack.com](http://www.Pasternack.com). For each part, we show an indicator of compliance using this symbol:



All products displaying this symbol on our website have been certified as RoHS Compliant. Click on this symbol to view the Certificate of RoHS Compliance for this product.

We recognize that you may have specific questions regarding RoHS certification on Pasternack's components and products. We will be happy to process all such requests as quickly as possible. Please direct any such requests to Pasternack Enterprises Technical Support via email at [TechSupport@Pasternack.com](mailto:TechSupport@Pasternack.com) or by calling Toll-Free within North America at 1-866-PASTERNAK (866-727-8376). International customers, please use +1-949-261-1920.

## Methods Determining RoHS Compliance

RoHS Compliance is determined by a combination of supplier certification and engineering design verification. In most cases, Pasternack's products were determined to be RoHS Compliant. In many cases, the Compliance was through a stated Exemption to the RoHS Directive. As a supplier of coaxial connectors, adapters, and RF components, Pasternack uses materials such as Brass and Stainless Steel which contain lead as a percentage of weight above the 0.1% threshold, but are allowed through the Exemptions as of the October 21<sup>st</sup>, 2005 RoHS Directive amendment. Pasternack uses these Exemptions to the RoHS Directive where applicable.

## What are the Exemptions?

*RoHS Directive text as of the Oct 21<sup>st</sup>, 2005 amendment is underlined, and how it applies to Pasternack products is indicated below each Exemption.*

### ANNEX to ROHS DIRECTIVE 2002/95/EC

**"Applications of lead, mercury, cadmium, hexavalent chromium, polybrominated biphenyls (PBB) or polybrominated diphenyl ethers (PBDE) which are exempted from the requirements of Article 4(1)":**

5. Lead in glass of cathode ray tubes, electronic components and fluorescent tubes.  
Some Pasternack products use resistive and/or dielectric inks that contain lead in a glass phase and fall under this exemption 5.
6. Lead as an alloying element in steel containing up to 0.35% lead by weight, aluminum containing up to 0.4% lead by weight and as a copper alloy containing up to 4% lead by weight.  
Most Pasternack products use metal alloys that contain lead below the maximum concentration values specified under this exemption 6. Specifically: aluminum alloys, brass, stainless steel, beryllium copper and phosphor bronze.
7. Lead in solders for servers, storage and storage array systems, network infrastructure equipment for switching, signaling, transmission as well as network management for telecommunications.

All Pasternack coaxial cable assemblies are made using solder containing lead (unless lead-free solder is specified), and may be used in network infrastructure equipment and therefore would fall under this exemption 7. This exemption is application specific, however, and we therefore leave it up to our customer to determine whether this exemption applies to their application.

**Pasternack has loaded new part numbers for cable assemblies using lead-free solder on our website, using the format PE3xxxxLF-yy, where "xxxx" identifies the part using the existing corresponding item number, and "yy" identifies the length in inches. For example, PE3067LF-24 is the same as PE3067-24 (BNC Male to BNC Male, RG58C/U), except it uses lead-free solder to be fully ROHS Compliant.**

# MAILING LIST CHANGES

If you receive more than one catalog with the same name and address, please notify Pasternack and pass the catalog along to a friend. Also, if you do not require multiple copies to the same company address, contact a sales representative to verify and modify your mailing information. A forms-based communications method to add, delete or modify mailing information is available at [www.pasternack.com](http://www.pasternack.com). By clicking "Contact Us", and then clicking "Remove Name from Mailing List", you may complete the form to request a change to your mailing preferences. In addition, by clicking "Catalog", and then clicking "Request a Printed Catalog", you may add your contact information to our mailing list. Please note service opt-in and opt-out options located on the forms. Alternatively, you may mail, email, telephone or fax Pasternack your request.

## PLACING YOUR ORDER

► **By Telephone: 866-PASTERNAK (866-727-8376)**  
US & Canada, or 949-261-1920

Our friendly sales representatives are ready to serve you from 5:00am to 5:30pm Pacific Standard Time (PST), Monday through Friday. For the most efficient service, please have ready a list of quantities and part numbers and, if paying by credit card, your MasterCard, VISA, American Express or Discover card. Note: Calls may be recorded or monitored for quality and training purposes.

► **By Fax: 949-261-7451**

Our fax lines can be accessed 7 days a week, 24 hours a day. Orders received after 4:00pm PST will be promptly processed and shipped the next business day. Please include your daytime phone number and/or email address in case we have any questions about your order.

► **By Internet: [www.Pasternack.com](http://www.Pasternack.com)**  
or Email: [sales@pasternack.com](mailto:sales@pasternack.com)

Order online 7 days a week, 24 hours a day using our online ordering system. Just search for the items you want and add them to your shopping cart. Internet orders entered after 4:00 pm PST will be promptly processed and shipped the next business day.

► **By Mail: Simply Mail Your Order To:**  
Pasternack Enterprises, Inc.  
17802 Fitch  
PO Box 16759  
Irvine, CA 92623-6759 USA

International customers, please see "International Orders" below for additional information.

### Terms and Conditions of Sale:

The following from Pasternack's Binding Terms and Conditions of Sale are provided for your convenience. A complete documentation of the Binding Terms and Conditions of Sale may be found in the back of the catalog, or on Pasternack's website at <http://www.pasternack.com/TermsOfSale.aspx>. Any questions or clarifications may be answered by contacting Customer Service at (+1) 949-261-1920 or by any of the methods listed above.

### Minimum Order:

A minimum order of \$50.00 is required. There is no minimum line item required.

### Handling Charge:

A \$10.00 handling charge applies to all orders less than \$100.00. This fee will be waived on orders of \$100.00 or more.

### Ground Freight is Free:

On UPS Ground orders, there is no charge for shipping for USA & Canada orders of \$100.00 or greater. Otherwise, shipping or freight charges and insurance will be paid by the customer. All sales are made FOB Point (as defined by the INCOTERMS 2000) in Irvine, CA USA. Shipping or freight charges from Pasternack's Irvine, CA factory are prepaid and added to the invoice or billed collect.

### Same-Day Shipment:

Same-day shipment will apply to orders received Monday through Friday, prior to 4:00pm PST.

- All UPS air and surface options
- All FedEx air options (with an approved account number)
- Most other shipping options, including DHL (with an approved account number) and USPS

### Counter-to-Counter Shipping:

For your urgent order requiring our fastest shipping method, we will place your order on the next available flight from Santa Ana-Orange County John Wayne International Airport (Airport code: SNA) to the destination you specify. Please call for details.

### Payment Terms:

Pasternack offers a number of convenient payment methods:

For United States customers, we offer check, money order, MasterCard, VISA, American Express, Discover, and C.O.D. as well as open account credit to qualified institutions and businesses. Payment must be made in US Dollars.

For Canadian customers, we offer all of the above payment options except C.O.D.  
For International customers, see International Orders.

### Open Account Credit:

Net 30 Days terms are available to businesses, schools and agencies subject to credit approval. Approval can begin by submitting a completed Credit Application, which can be found online at: [www.Pasternack.com/CreditApplication.aspx](http://www.Pasternack.com/CreditApplication.aspx)

### EFT/Wire Transfers:

Please contact us for details. We will inform you of the total amount which will include shipping charges and any applicable wire transfer fees. Orders will not be accepted until funds have been received in full.

### WELLS FARGO BANK

420 Montgomery St.  
San Francisco, CA 94104 USA  
Account Number: 4270 0000 0000 0000 1  
Routing Number: 121000248  
SWIFT Number: WFBUS6S

### International Orders:

In addition to the United States and its territories, Pasternack accepts international orders. All orders of international origin are exported from the US in accordance with the Export Administration Regulations. Diversion contrary to US Law is prohibited. Please see Pasternack's Binding Terms and Conditions of Sale for full details.

Pasternack has international distributors for the following countries:

**Asia-Pacific:** Australia, China PRC, India, Indonesia, Japan, Korea, Malaysia, New Zealand, Singapore, Taiwan, Thailand

**Europe:** Czech Republic, Denmark, Finland, France, Germany, Ireland, Italy, Norway, Slovakia, Sweden, Switzerland, Turkey, United Kingdom

**Middle East:** Israel

To access their complete contact information, please see our International Distributors section in this catalog.

### International Shipping Charges:

Shipping or freight charges and insurance will be paid by the customer. All sales are made FOB Point (as defined by the INCOTERMS 2000) in Irvine, CA USA. We ship orders by UPS, FedEx (with an approved account number), or DHL (with approved account number) with delivery in 2 to 3 days to most locations worldwide.

### International Taxes and Duties:

Customer is responsible for duties and taxes.



Real-Time Stock Levels & Pricing On Our WebSite



Toll-Free Technical Support (866) 727-8376



Same-Day Shipping, Even Custom Cable Assemblies

# BINDING TERMS AND CONDITIONS OF SALE

The following are the terms and conditions ("Terms and Conditions") for the sale of products ("Products") by Pasternack Enterprises, Inc. ("Pasternack") to Pasternack's customers ("Customers"). Please read this agreement carefully. Any different or additional terms set forth in customer's purchase order or similar communication are objected to and shall not be binding on the company unless a separate agreement has been signed by an authorized officer of the company. By placing an order for products from the company, or by accepting delivery of the products described on the applicable packing slip, bill of lading and/or invoice received with the products, you agree to be bound by and accept these terms and conditions of sale.

## 1. ACCEPTANCE AND CANCELLATION OF ORDERS

All orders are subject to acceptance by Pasternack in writing by a duly authorized agent of Pasternack; any written acknowledgement of receipt of an order shall not, in and of itself, constitute such acceptance. Orders accepted and processed by Pasternack may not be cancelled by Customer except as covered by the Limited Warranty, all sales are final. Cable Assemblies and Non-Standard Products are also Non-Cancelable/Non-Refundable ("NC/NR"). Non-Standard Parts are defined as Products which are special orders, custom orders, orders for non-standard products, products not customarily in stock or orders for value-added products. In the event of cancellation or other withdrawal of an order for any reason and without limiting any other remedy which Pasternack may have as a result of such cancellation or other withdrawal, reasonable cancellation or restocking charges, which shall include all expenses then incurred and commitments made by Pasternack, shall be paid by Customer to Pasternack. Customer requests to reschedule are subject to acceptance by Pasternack in its sole discretion. Orders may not be rescheduled after the order has been submitted by Pasternack to the shipment carrier.

## 2. PRICES

Orders are billed at the prices (in US dollars) in effect at the time of shipment. Prices will be as specified by Pasternack and will be applicable for the period specified in Pasternack's quote. If no period is specified, quoted prices will be applicable for thirty (30) days. The catalog reflects the latest pricing information available at the time of printing. Prices shown in the catalog are subject to change without notice. Prices are subject to change in the event of a change in Pasternack's costs or other circumstances beyond Pasternack's reasonable control. Prices are exclusive of taxes, impositions and other charges, including: sales, use, excise, value added and similar taxes or charges imposed by any government authority, international shipping charges, forwarding agent's and broker's fees, bank fees, consular fees, document fees and import duties.

## 3. TERMS OF PAYMENT

All payments must be in US Dollars, or will be converted to US Dollars using the available exchange rate at the time of purchase.

Credit cards accepted are MasterCard, VISA, Discover, and American Express credit cards, purchase cards and major bank debit cards. Payment via net thirty (30) days is available to businesses, schools and agencies or as otherwise specified by Pasternack subject to approved credit.

### For International Orders

Credit cards accepted are MasterCard, VISA, and American Express. Payment via open credit account with Net thirty (30) days can be established for companies having three U.S. references. Prepaid Wire Transfer: You can wire the funds to our bank. We will contact you with the total amount which will include shipping charges and a \$40 wire transfer fee. Orders will not be accepted until funds have been received in full and Purchase Order (PO) has been received. Customer is responsible for duties and taxes.

## 4. SALES TAX

Only California residents need to remit sales tax. Pasternack does not remit sales tax to states other than California. Any sales tax due that is not collected by Pasternack is the responsibility of the customer.

## 5. TOLERANCES

All coaxial cable assemblies displayed in the Pasternack catalog and website have a standard cable length tolerance of  $\pm 1.5\%$  or  $\frac{3}{8}$  inches (0.375"), whichever is greater. Cable Assemblies in excess of this tolerance factor are eligible for repair and / or replacement under the terms of the Pasternack Limited Warranty.

## 6. DELIVERY AND TITLE

Shipping or freight charges and insurance will be paid by the customer. All sales are made FCA Shipping Point (as defined by the INCOTERMS 2000) in Irvine, CA USA. Shipping or freight charges from Pasternack's Irvine, CA facility are prepaid and added to the invoice, or billed collect. Subject to Pasternack's right of stoppage in transit, delivery of the Products to the carrier will constitute delivery to Customer and title and risk of loss will pass to Customer. Pasternack will make reasonable efforts to initiate shipment and schedule delivery as close as possible to Customer's requested delivery date(s). Customer acknowledges that delivery dates provided by Pasternack are estimates only and that Pasternack will not be liable for failure to deliver on such dates. Selection of the carrier and delivery route will be made by Pasternack unless specifically designated by Customer. Pasternack reserves the right to make deliveries in installments. Delay in delivery of one installment will not entitle Customer to cancel any other installment(s). Delivery of any installment of Products within thirty (30) days after the date requested will constitute a timely delivery. Delivery of a quantity which varies from the quantity specified shall not relieve Customer of the obligation to accept delivery and pay for the Products delivered.

## 7. PASTERNAK'S LIMITED WARRANTY

All products are covered by a LIMITED WARRANTY for a period of ninety (90) days from the date of shipment when purchased from Pasternack Enterprises, Inc. Customer must notify Pasternack within 90 days from date of shipment of any defective product. An approved Return Materials Authorization (RMA) number must first be obtained from Pasternack prior to the return of any merchandise to Pasternack for inspection under warranty. Shipping charges for all materials returned under this Limited Warranty are to be prepaid by the Customer. This warranty is limited to the original purchaser. Pasternack's liability arising out of any sale of products to Customer is expressly limited to either (1) Credit for the purchase price paid by Customer for such products (without interest), or (2) Repair and/or replacement of such products, found to be defective after inspection by Pasternack, and such remedies shall be exclusive and in lieu of all others. This warranty is in lieu of any and all other warranties, whether oral, written, expressed, implied or statutory. Further, no warranty will apply if the Product has been subject to misuse, neglect, accident or modification, or has been soldered or altered in any way.

All returns must be shipped to:  
Pasternack Enterprises, Inc.  
17802 Fitch  
Irvine, CA 92614 USA

## 8. LIMITATION OF LIABILITIES

In no event shall Pasternack be liable for any special, incidental or consequential damages of any nature including, but not limited to, damages resulting from loss of profit or revenue, recall costs, claims for service interruptions or failure to supply downtime, testing, installations or removal costs, costs of substitute products, property damage, personal injury, death or legal expenses. Customer's recovery from Pasternack for any claim shall not exceed the purchase price paid by Customer for the goods, irrespective of the nature of the claim, whether in warrant, contract or otherwise. CUSTOMER SHALL INDEMNIFY, DEFEND AND HOLD PASTERNAK HARMLESS FROM ANY CLAIMS brought by any party regarding products supplied by Pasternack and incorporated into the customer's product.

## 9. STATEMENTS AND ADVICE

If statements or advice, technical or otherwise, are offered or given to Customer, such statements or advice will be deemed to be given as an accommodation to Customer and without charge and Pasternack shall have no responsibility or liability for the content or use of such statements or advice.

## 10. EXPORT CONTROL

Products purchased or received under these Terms and Conditions are subject to export control laws, restrictions, regulations and orders of the United States. Customer agrees to comply with all applicable export laws, restrictions and regulations of the United States or foreign agencies or authorities, and shall not export, or transfer for the purpose of re-export, any product to any prohibited or embargoed country, including but not limited to The Balkans, Belarus, Burma, Cote d'Ivoire, Cuba, the Democratic Republic of the Congo, Iran, Iraq, North Korea, Sudan, Syria, and Zimbabwe, or to any denied, blocked, or designated person or entity as mentioned in any such United States or foreign law or regulation. Customer represents and warrants that it is not on the Denied Persons, Specially Designated Nationals or Debarred Persons List (as identified by the U.S. Treasury Office of Foreign Asset Control (OFAC) and by the U.S. Department of Commerce, Bureau of Industry and Security (BIS)), or any other United States or other government list of prohibited persons; and otherwise prohibited by United States or other law from purchasing the products or services hereunder. Customer shall be solely responsible to obtain any license to export, re-export or import as may be required.

## 11. GENERAL

The Terms and Conditions may not be modified or cancelled without Pasternack's written agreement. Accordingly goods furnished and services rendered by Pasternack are sold only on the terms and conditions stated herein. The Terms and Conditions will be governed by and construed in accordance with the laws of the State of California and the applicable laws of the United States of America. If Customer chooses to access the Pasternack Web Site from outside the United States, Customer does so on their own initiative and is responsible for compliance with all applicable local laws.

## 12. INTELLECTUAL PROPERTY

The drawings, text, product depictions, logos, content, product descriptions, and organization and taxonomy of this catalog and of the described content within this catalog are proprietary to Pasternack and protected by intellectual property laws, including but not limited to United States Copyright law and United States Trademark law. Pasternack owns copyrights in these referenced works as well as the selection, arrangement, coordination and structure of the arranged content and works within this catalog. Use of this catalog does not give you any right to modify, reproduce, transmit, publish, publicly display, adapt, or create derivative works or in any way exploit any of the materials and content of this catalog.

# GLOSSARY OF RF TERMS

---

**Absorption:** The loss of power resulting from conversion of power into heat.

**Albaloy:** A "tri-metal" plating finish comprised primarily of copper, tin and zinc which provides good electrical performance. It also provides excellent passive intermodulation (PIM) performance comparable to silver.

**Attenuation:** Attenuation, measured in decibels (dB), is the reduction in signal power that occurs when a signal travels over long distances.

**Bandwidth:** The difference between the upper and lower frequencies in a continuous set of frequencies.

**Circulator:** A passive, three-port device used to control the direction of signal flow in an RF circuit.

**Coaxial Cable:** A cable with an inner conductor surrounded by a flexible and tubular insulating layer, then surrounded by a tubular conducting shield.

**Coaxial Connector:** Typically used with coaxial cables, these connectors are designed to maintain shielding and minimize the change in transmission line impedance at the connection. A RF connector is an electrical connector designed to work at radio frequencies.

**Contact:** The part of an interconnect that interfaces between the connector and the lead or coaxial center conductor on the device being connected.

**DC block:** A capacitor that allows you to separate Direct Current (DC) voltages along a transmission line.

**Decibel (dB):** A decibel is a logarithmic unit expressing the ratio of two powers. It is ten times the logarithm to base 10 of the ratio of two powers.

**Dielectric:** In a coaxial cable, the dielectric is the insulation between the inner and outer conductor. Dielectric influences the electrical properties such as impedance and velocity.

**Diode:** An electronic device with low resistance that allows current to flow in only one direction.

**DWV:** Acronym for Dielectric Withstanding Voltage. DWV is the minimum voltage requirement of a connector's insulating material to ensure high voltage surges will not cause dielectric failure.

**Ferrule (Coaxial):** A short tube used to make solderless connections to a coaxial cable (as in crimping)

**Ferrule (FO):** A component of a fiber optic connection that aligns and holds a fiber in place.

**Fiber Optics:** The transmission of radiant energy (or light) through an optical wave guide, generally made of glass or plastic.

**Flange:** A projection with holes extending a connector or waveguide that permits mounting the connector or waveguide to a panel, or to another mating half.

**Frequency:** Is a signal of AC alternating current (AC) that swings from a high peak to a negative point. Each swing from crest to trough of the wave is called a cycle. Frequency is the number of cycles per second that is measured in Hz (Hertz), where 1 Hz = 1 CPS (Cycles per second)

**Gain:** The ratio of power output to the power input of the amplifier in dB.

**GHz:** Frequency measurement that equals a billion cycles per second. For example, 7 GHz = 7 billion cycles per second.

**Impedance:** A measurement of resistance calibrated in "Ohms" which varies with frequency.

**Insertion Loss:** In a transmission system, it is the change in load power due to the insertion of a particular device.

**Jacket:** On a coaxial cable, it is a non-metallic, outer protective cover applied over an insulated wire or cable.

**Land Mobile Radio:** Also referred to as LMR, is a wireless communications system intended for terrestrial use, typically by users in vehicles or on foot.

**MHz:** Frequency measurement that equals a million cycles per second. For example, 3 MHz = 3 million cycles per second.

**Microwave:** A wavelength on the electromagnetic spectrum lying between the infrared and the radio frequency range. Microwaves extend from 1 GHz to 300 GHz.



Free Freight Available  
via UPS Ground  
to USA & Canada



Real-Time Stock  
Levels & Pricing  
On Our WebSite



Toll-Free Technical  
Support  
(866) 727-8376



Same-Day Shipping,  
Even Custom  
Cable Assemblies



# GLOSSARY OF RF TERMS

---

**MIL:** Abbreviation for "Military" (as in Military Standards.)

**Mixer:** Provides frequency translation from the input signal to the output signal. It is a nonlinear electrical circuit that creates new frequencies from two signals applied to it.

**Noise:** Random electrical signals, generated by circuit components or by environmental disturbances.

**Passive Intermodulation (PIM):** Simply put, Passive Intermodulation (PIM) is interference of a signal. PIM is a nonlinear response that occurs when two or more signals are present in a passive device such as a cable, connector, coupler. PIM is typically caused by dissimilar metals or dirty/loose interconnects.

**Phase Shift:** The change in time experience by voltage or current after passing through a circuit or cable. Phase shift is a delay in time that is commonly expressed in degrees or picoseconds when it relates to connectors or cable assemblies.

**Polarization:** Describes how a material responds to an applied electric field as well as the way the material changes the electric field.

**Propagation:** Moving or Transmitting energy along a path.

**Pulse:** A rapid change in signal level over a relatively short period of time.

**Receiver:** A device that detects a signal and converts it into an electrical form that is usable by other electronic devices.

**Return Loss:** Expressed in dB, it is a measure of the amount of reflected power on a transmission line when it is terminated or connected to any passive or active device.

**RF Leakage:** The amount of signal frequency which radiates (leaks) from the RF connector or cable.

**RG/U:** Symbol for cables that are made to Government Specification. The "R" stands for Radio Frequency, the "G" means Government, the corresponding number specifies the government approval, and the "U" means it is a universal specification.

**Rubber Duck Antenna:** An electrically short, omnidirectional antenna used on wireless devices such as GPS receivers. These antennas typically have a flexible plastic shield.

**Semi-Rigid:** A cable with rigid outer conductor that contains a flexible inner conductor and dielectric that form a coaxial transmission line.

**Shielding:** The metal sleeve surrounding the conductors in a wire circuit or cable to prevent interference or leakage.

**Surface Mount Device:** Abbreviated as SMD, it is an active or passive device designed to be soldered to the surface of a printed circuit board.

**Temperature:** Refers to the minimum and maximum temperatures that a given component can operate at while still meeting all specifications unless otherwise noted.

**Termination:** Also known as a Load, terminations are used at the end of a transmission line and are designed to absorb RF power with very little reflection, effectively terminating the line.

**Torque:** Recommended mating torque for industry standard connectors: SMA = 7 to 10 in-lbs; Type-N = 12 to 15 in-lbs; TNC = 12 to 15 in-lbs; 7/16 DIN = 220 to 300 in-lbs.

**Twinax Cable:** Similar to coax cable, but has two inner conductors instead of one. Typically used for very-short-range applications.

**Twinax Connector:** Two-Pole symmetrical connectors that maintain a balanced transmission line. Twinax connectors are ideal for applications using shielded twin-wire cables with different impedances in the range of 75 to 95 Ohms.

**VSWR:** Abbreviation for Voltage Standing Wave Ratio. VSWR is an efficiency measurement of how radio frequency is transmitted from a power source through a transmission line, into a termination (or load).

**Waveguide:** Used at microwave frequencies, waveguides are metallic transmission lines typically used to interconnect transmitters and receivers with antennas.

**Yagi:** A directional, shortwave radio antenna consisting of a horizontal conductor with several insulated dipoles parallel to and in the plane of the conductor.



# PART NUMBER INDEX

Note: C/R stands for the Column and/or Row location of the specific product on a given page.

Model No.	Page	C/R	Model No.	Page	C/R	Model No.	Page	C/R	Model No.	Page	C/R	Model No.	Page	C/R
PE1001	237	3	PE2058	202	4	PE3052	67	12	PE3218	51	1	PE3364	67	14
PE1002	237	1	PE2059	202	7	PE3054	66	5	PE3221	Web		PE3365	68	18
PE1003	237	10	PE2060	202	9	PE3056	32	27	PE3223	36	25	PE3366	67	10
PE1004	238	2	PE2061	204	4	PE3057	55	25	PE3224	Web		PE3367	38	10
PE1005	238	3	PE2062	204	2	PE3058	36	28	PE3226	Web		PE3368	Web	
PE1006	238	4	PE2063	202	14	PE3061	51	22	PE3227	49	9	PE3369	30	10
PE1007	238	5	PE2064	202	16	PE3062	46	27	PE3230	Web		PE3370	67	4
PE1008	238	6	PE2065	202	18	PE3067	64	14	PE3231	56	1	PE3371	66	14
PE1009	238	7	PE2066	202	17	PE3071	48	4	PE3232	48	22	PE3373	67	2
PE1513	212	3	PE2067	202	13	PE3074	53	18	PE3233	Web		PE3375	66	9
PE1514	212	2	PE2068	202	15	PE3075	65	14	PE3234	37	5	PE3376	70	2
PE1515	212	5	PE2069	202	12	PE3076	Web		PE3236	63	2	PE3377	30	19
PE1516	212	4	PE2070	Web		PE3078	32	24	PE3238	57	17	PE3378	Web	
PE1517	212	6	PE2071	202	25	PE3079	66	16	PE3240	57	14	PE3380	35	5
PE1518	212	7	PE2072	203	14	PE3080	Web		PE3242	62	24	PE3381	Web	
PE1519	212	8	PE2073	203	22	PE3081	64	16	PE3244	57	13	PE3382	Web	
PE1520	212	9	PE2074	202	24	PE3082	65	23	PE3245	30	15	PE3384	Web	
PE1521	212	10	PE2075	203	13	PE3083	58	9	PE3246	51	23	PE3385	30	11
PE1522	212	12	PE2076	203	21	PE3085	68	20	PE3248	51	24	PE3387	31	9
PE1523	212	13	PE2200	199	22	PE3087	65	8	PE3250	51	28	PE3388	Web	
PE1524	212	11	PE2201	200	1	PE3088	Web		PE3252	51	19	PE3389	67	7
PE1525	212	1	PE2202	200	4	PE3089	Web		PE3253	Web		PE3393	Web	
PE1603	206	42	PE2203	200	7	PE3093	Web		PE3254	51	30	PE3394	52	22
PE1604	206	38	PE2204	200	8	PE3094	Web		PE3255	48	8	PE3395	Web	
PE1605	206	41	PE2205	200	11	PE3095	58	11	PE3256	52	2	PE3396	69	29
PE1606	206	27	PE2206	200	13	PE3097	51	26	PE3258	56	4	PE3398	69	31
PE1607	206	28	PE2207	200	14	PE3098	68	9	PE3259	Web		PE3400	Web	
PE1608	206	29	PE2208	199	23	PE3100	71	4	PE3261	51	29	PE3402	53	12
PE1609	206	30	PE2209	200	2	PE3102	33	5	PE3263	56	5	PE3404	69	32
PE1610	206	31	PE2210	200	5	PE3103	66	30	PE3264	64	12	PE3405	Web	
PE1611	206	32	PE2211	200	9	PE3104	Web		PE3265	Web		PE3407	49	34
PE1612	206	33	PE2212	200	12	PE3108	Web		PE3268	49	27	PE3408	Web	
PE1613	206	34	PE2213	199	24	PE3109	36	2	PE3269	Web		PE3409	Web	
PE1614	206	35	PE2214	200	3	PE3112	Web		PE3271	Web		PE3411	Web	
PE1615	206	36	PE2215	200	6	PE3113	65	25	PE3272	49	23	PE3412	49	28
PE1616	206	37	PE2216	200	10	PE3116	66	3	PE3273	Web		PE3413	66	31
PE1617	206	39	PE2217	201	12	PE3117	69	8	PE3275	Web		PE3414	53	2
PE1618	206	40	PE2218	201	13	PE3120	69	21	PE3278	Web		PE3416	58	3
PE2000	202	20	PE2219	201	14	PE3121	30	18	PE3279	47	8	PE3417	35	7
PE2001	203	16	PE2220	201	14	PE3122	Web		PE3280	51	8	PE3418	52	19
PE2002	203	37	PE2221	201	16	PE3130	62	5	PE3282	51	6	PE3420	32	2
PE2003	202	21	PE2222	201	17	PE3133	Web		PE3285	51	7	PE3421	52	26
PE2004	203	18	PE2223	201	18	PE3134	63	6	PE3288	51	9	PE3422	37	3
PE2005	203	39	PE2224	201	19	PE3137	Web		PE3290	60	12	PE3423	66	29
PE2006	203	35	PE2226	200	16	PE3138	31	1	PE3291	36	37	PE3424	Web	
PE2007	203	12	PE2227	201	5	PE3139	Web		PE3293	Web		PE3425	52	24
PE2008	202	22	PE2228	201	1	PE3141	34	24	PE3295	60	11	PE3427	Web	
PE2009	203	19	PE2229	201	7	PE3143	48	1	PE3297	60	12	PE3428	34	27
PE2011	202	26	PE2230	201	8	PE3145	64	9	PE3299	60	19	PE3429	32	7
PE2012	203	23	PE2231	201	4	PE3147	Web		PE3301	61	1	PE3430	53	13
PE2014	203	1	PE2232	201	6	PE3149	35	20	PE3302	37	7	PE3431	66	23
PE2015	203	25	PE2233	201	11	PE3152	35	21	PE3304	60	18	PE3434	52	25
PE2017	203	5	PE2234	201	10	PE3154	38	13	PE3306	61	2	PE3435	53	1
PE2018	203	28	PE2235	201	9	PE3156	35	18	PE3307	69	25	PE3436	66	22
PE2020	203	7	PE2236	201	3	PE3157	63	7	PE3309	60	15	PE3437	57	19
PE2021	203	30	PE2237	200	15	PE3158	64	8	PE3311	60	16	PE3440	Web	
PE2023	203	10	PE2238	199	25	PE3159	55	22	PE3314	60	14	PE3441	46	20
PE2024	203	33	PE2239	201	2	PE3160	33	6	PE3316	60	17	PE3442	66	24
PE2026	203	3	PE300	15	1	PE3163	65	10	PE3318	37	11	PE3443	33	8
PE2027	203	32	PE301	15	2	PE3164	73	16	PE3319	31	25	PE3444	Web	
PE2028	203	4	PE302	15	3	PE3166	61	11	PE3320	49	1	PE3445	65	20
PE2029	203	27	PE303	15	4	PE3168	48	5	PE3321	37	1	PE3446	66	25
PE2030	203	9	PE304	15	5	PE3170	Web		PE3323	36	33	PE3447	47	1
PE2031	203	26	PE306	15	7	PE3171	33	2	PE3325	65	28	PE3448	37	14
PE2032	202	23	PE308	15	9	PE3172	40	7	PE3327	Web		PE3450	Web	
PE2033	202	27	PE309	15	10	PE3174	38	20	PE3330	65	26	PE3451	Web	
PE2034	203	38	PE310-KIT	7	21	PE3176	38	18	PE3332	66	1	PE3454	66	28
PE2035	203	6	PE311	15	11	PE3178	38	15	PE3333	Web		PE3455	46	22
PE2036	203	8	PE312	15	12	PE3179	Web		PE3334	Web		PE3457	69	16
PE2037	203	11	PE315	16	1	PE3181	40	8	PE3338	69	12	PE3458	67	8
PE2038	203	20	PE317	16	2	PE3182	64	10	PE3340	58	14	PE3459	32	13
PE2039	203	24	PE319	17	1	PE3183	Web		PE3341	69	28	PE3460	65	24
PE2040	203	2	PE321	17	2	PE3184	33	24	PE3343	69	20	PE3462	65	18
PE2041	203	29	PE3000	67	16	PE3185	Web		PE3344	32	9	PE3466	53	15
PE2042	203	31	PE3003	32	10	PE3187	40	13	PE3345	37	29	PE3468	34	1
PE2043	203	34	PE3005	73	10	PE3188	33	11	PE3346	67	25	PE3470	65	4
PE2044	202	19	PE3010	Web		PE3189	Web		PE3347	34	26	PE3472	47	17
PE2045	203	15	PE3013	37	28	PE3190	Web		PE3348	Web		PE3476	51	27
PE2046	203	36	PE3015	55	17	PE3192	Web		PE3349	62	25	PE3477	51	20
PE2047	203	17	PE3020	65	22	PE3193	38	1	PE3351	67	3	PE3479	41	7
PE2048	204	1	PE3023	Web		PE3194	Web		PE3352	32	4	PE3480	73	8
PE2049	204	3	PE3025	66	33	PE3199	Web		PE3353	30	13	PE3481	31	4
PE2050	202	1	PE3034	49	2	PE3200	Web		PE3354	66	20	PE3483	32	15
PE2051	202	2	PE3038	58	10	PE3205	55	4	PE3355	65	27	PE3485	48	32
PE2052	202	3	PE3041	71	3	PE3207	50	23	PE3357	58	13	PE3487	47	3
PE2053	202	5	PE3042	51	21	PE3210	39	12	PE3358	66	2	PE3488	49	13
PE2054	202	6	PE3044	67	1	PE3211	64	7	PE3359	41	19	PE3490	Web	
PE2055	202	8	PE3047	66	10	PE3214	Web		PE3360	66	8	PE3492	31	14
PE2056	202	10	PE3050	35	22	PE3216	Web		PE3361	30	16	PE3494	33	23
PE2057	202	11	PE3051	33	26	PE3217	49	5	PE3362	Web		PE3495	64	17

Appendix

# PART NUMBER INDEX

Note: C/R stands for the Column and/or Row location of the specific product on a given page.

Model No.	Page	C/R	Model No.	Page	C/R	Model No.	Page	C/R	Model No.	Page	C/R	Model No.	Page	C/R
PE3496	46	26	PE3642	42	23	PE3819	35	11	PE3992	69	9	PE33430	73	1
PE3497	54	1	PE3644	50	6	PE3820	35	12	PE3993	Web		PE33432	73	2
PE3498	54	7	PE3646	35	8	PE3821	32	18	PE3995	Web		PE33434	73	3
PE3499	46	19	PE3649	66	21	PE3822	32	19	PE3996	48	21	PE33436	Web	
PE3500	30	22	PE3650	48	23	PE3823	33	15	PE3997	46	28	PE33437	72	12
PE3501	67	24	PE3651	33	9	PE3824	33	16	PE3999	64	15	PE33438	55	28
PE3502	73	15	PE3652	50	4	PE3825	34	7	PE33001	37	18	PE33439	Web	
PE3504	52	21	PE3653	47	6	PE3826	34	8	PE33003	31	13	PE33440	67	18
PE3505	67	15	PE3654	36	34	PE3827	47	23	PE33009	68	1	PE33441	72	13
PE3508	66	4	PE3655	34	20	PE3828	37	20	PE33011	Web		PE33442	67	20
PE3510	32	5	PE3656	31	8	PE3829	Web		PE33013	53	3	PE33443	72	14
PE3511	34	25	PE3657	37	15	PE3830	49	14	PE33014	Web		PE33444	Web	
PE3512	32	1	PE3658	41	18	PE3832	33	1	PE33018	Web		PE33445	Web	
PE3513	32	8	PE3660	57	15	PE3835	33	28	PE33021	49	35	PE33446	73	11
PE3514	34	21	PE3661	50	3	PE3836	35	25	PE33047	35	34	PE33447	Web	
PE3515	34	28	PE3662	36	35	PE3842	67	6	PE33053	Web		PE33448	Web	
PE3516	68	10	PE3664	38	14	PE3843	69	4	PE33068	69	1	PE33449	73	12
PE3517	Web		PE3665	50	8	PE3845	55	20	PE33071	46	10	PE33450	73	4
PE3518	69	17	PE3666	50	11	PE3849	57	18	PE33073	Web		PE33451	73	6
PE3519	37	4	PE3667	48	24	PE3850	Web		PE33084	Web		PE33452	73	5
PE3520	36	12	PE3669	36	29	PE3852	58	8	PE33098	Web		PE33454	Web	
PE3521	35	44	PE3671	63	1	PE3853	61	6	PE33117	38	4	PE33455	Web	
PE3522	Web		PE3672	62	26	PE3854	66	27	PE33120	35	32	PE33456	73	7
PE3524	Web		PE3673	46	8	PE3857	Web		PE33121	62	16	PE33457	Web	
PE3525	Web		PE3674	66	12	PE3858	35	6	PE33122	Web		PE33458	Web	
PE3528	69	24	PE3675	Web		PE3864	33	3	PE33123	65	16	PE33476	62	18
PE3530	63	4	PE3678	65	21	PE3865	32	3	PE33130	65	2	PE33479	Web	
PE3531	34	3	PE3679	Web		PE3867	31	5	PE33143	61	18	PE33481	37	32
PE3534	Web		PE3681	Web		PE3871	Web		PE33144	Web		PE33482	Web	
PE3535	38	19	PE3684	Web		PE3874	52	1	PE33154	56	16	PE33491	Web	
PE3538	65	1	PE3686	49	6	PE3876	34	23	PE33158	36	5	PE33502	36	24
PE3539	42	2	PE3689	65	29	PE3882	49	25	PE33165	61	7	PE33516	Web	
PE3542	Web		PE3693	49	21	PE3883	56	13	PE33168	49	29	PE33518	36	15
PE3543	56	3	PE3694	68	14	PE3885	41	13	PE33175	61	16	PE33519	41	16
PE3544	52	23	PE3696	41	10	PE3886	42	17	PE33176	36	16	PE33521	41	20
PE3545	Web		PE3697	32	29	PE3887	37	19	PE33178	49	38	PE33523	41	14
PE3548	40	10	PE3698	49	20	PE3895	Web		PE33179	72	15	PE33525	46	25
PE3551	54	2	PE3699	47	30	PE3898	55	27	PE33185	53	6	PE33527	46	24
PE3553	33	27	PE3704	30	21	PE3899	30	11	PE33188	72	4	PE33528	49	41
PE3557	66	26	PE3705	65	15	PE3901	Web		PE33189	Web		PE33530	Web	
PE3561	39	14	PE3706	32	28	PE3902	56	14	PE33191	36	19	PE33532	49	40
PE3562	41		PE3713	35	2	PE3903	Web		PE33196	72	9	PE33534	49	7
PE3568	36	36	PE3714	48	20	PE3904	Web		PE33197	72	1	PE33535	54	9
PE3570	46	18	PE3715	32	26	PE3906	65	7	PE33231	19	4	PE33536	Web	
PE3571	Web		PE3721	61	9	PE3908	40	9	PE33232	19	9	PE33537	58	4
PE3572	30	9	PE3722	40	12	PE3911	37	2	PE33233	21	3	PE33539	58	6
PE3573	30	20	PE3726	48	2	PE3914	68	11	PE33236	46	29	PE33541	Web	
PE3574	30	14	PE3733	42	20	PE3915	61	12	PE33247	71	6	PE33543	49	4
PE3577	68	16	PE3735	68	13	PE3916	62	11	PE33254	35	33	PE33545	49	37
PE3578	Web		PE3736	Web		PE3917	62	17	PE33257	42	18	PE33546	67	27
PE3580	55	24	PE3739	30	27	PE3918	57	7	PE33258	41	12	PE33547	35	31
PE3581	69	26	PE3743	Web		PE3919	57	10	PE33261	62	19	PE33548	Web	
PE3582	65	11	PE3745	41	11	PE3920	47	24	PE33267	55	21	PE33550	Web	
PE3583	64	13	PE3746	63	3	PE3921	Web		PE33269	47	2	PE33552	67	17
PE3584	65	9	PE3747	53	4	PE3922	Web		PE33270	71	5	PE33554	67	22
PE3587	61	8	PE3749	65	6	PE3924	33	30	PE33288	47	4	PE33555	38	2
PE3588	61	10	PE3750	51	25	PE3925	Web		PE33293	Web		PE33556	56	20
PE3589	62	13	PE3755	40	11	PE3929	Web		PE33304	58	7	PE33557	68	2
PE3590	62	15	PE3756	42	19	PE3930	73	9	PE33316	69	15	PE33559	Web	
PE3591	62	3	PE3758	35	40	PE3931	36	1	PE33321	48	9	PE33561	68	3
PE3592	61	17	PE3759	35	19	PE3932	36	11	PE33330	70	3	PE33563	68	4
PE3593	Web		PE3764	Web		PE3935	67	9	PE33349	Web		PE33565	68	5
PE3594	62	21	PE3765	57	8	PE3940	Web		PE33350	62	12	PE33567	68	6
PE3595	56	15	PE3769	38	9	PE3944	39	13	PE33352	57	4	PE33574	65	3
PE3596	56	17	PE3775	34	22	PE3949	66	13	PE33356	Web		PE33580	57	3
PE3597	57	9	PE3776	Web		PE3950	68	19	PE33361	38	16	PE33583	Web	
PE3598	Web		PE3777	66	11	PE3953	Web		PE33363	57	1	PE33586	70	4
PE3600	56	22	PE3778	30	17	PE3954	Web		PE33370	58	12	PE33600	42	22
PE3601	56	23	PE3779	32	6	PE3956	33	22	PE33377	47	15	PE33605	69	30
PE3602	Web		PE3780	42	16	PE3957	37	6	PE33382	36	4	PE33615	50	2
PE3604	67	13	PE3781	49	24	PE3958	32	16	PE33383	54	8	PE33641	56	12
PE3605	69	18	PE3782	47	22	PE3959	33	25	PE33391	Web		PE33643	57	6
PE3606	66	15	PE3790	21	1	PE3960	58	5	PE33396	Web		PE33644	Web	
PE3607	47	5	PE3792	66	19	PE3961	34	2	PE33399	72	3	PE33645	Web	
PE3608	53	7	PE3794	Web		PE3962	48	10	PE33401	72	5	PE33646	70	5
PE3611	32	25	PE3796	55	19	PE3963	47	18	PE33403	72	6	PE33647	Web	
PE3612	69	22	PE3797	48	3	PE3965	Web		PE33405	72	7	PE33649	Web	
PE3613	42	1	PE3799	33	33	PE3966	48	39	PE33407	72	8	PE33650	61	4
PE3614	37	8	PE3800	35	24	PE3967	33	32	PE33409	Web		PE33652	61	5
PE3615	41	8	PE3803	55	29	PE3971	Web		PE33412	72	10	PE33654	62	9
PE3616	69	23	PE3806	Web		PE3973	33	29	PE33414	72	11	PE33656	62	10
PE3617	48	27	PE3807	64	11	PE3977	48	26	PE33416	Web		PE33657	40	15
PE3618	69	27	PE3808	56	18	PE3979	48	36	PE33417	Web		PE33658	Web	
PE3623	55	16	PE3809	39	16	PE3982	50	10	PE33419	Web		PE33660	Web	
PE3626	42	3	PE3810	40	14	PE3983	Web		PE33420	Web		PE33662	Web	
PE3627	66	17	PE3811	42	21	PE3986	Web		PE33421	72	16	PE33664	Web	
PE3629	47	7	PE3814	30	26	PE3987	35	1	PE33423	Web		PE33666	61	15
PE3634	Web		PE3815	69	2	PE3988	Web		PE33425	Web		PE33668	Web	
PE3635	55	18	PE3816	67	5	PE3989	50	9	PE33426	Web		PE33669	Web	
PE3641	57	16	PE3818	31	15	PE3991	50	7	PE33428	Web		PE33670	61	19

# PART NUMBER INDEX

Note: C/R stands for the Column and/or Row location of the specific product on a given page.

Model No.	Page	C/R	Model No.	Page	C/R	Model No.	Page	C/R	Model No.	Page	C/R	Model No.	Page	C/R
PE33672	61	20	PE34178	38	5	PE34281	48	25	PE34462	57	11	PE34680	49	32
PE33673	38	17	PE34179	35	23	PE34282	53	14	PE34463	62	14	PE34681	71	7
PE33674	62	1	PE34180	31	11	PE34283	Web		PE34464	Web		PE34683	71	8
PE33675	62	22	PE34181	Web		PE34284	Web		PE34465	62	8	PE34685	Web	
PE33676	62	2	PE34182	31	12	PE34285	Web		PE34466	Web		PE34686	44	5
PE33680	62	6	PE34183	Web		PE34286	19	1	PE34467	62	20	PE34687	71	9
PE33682	Web		PE34184	31	10	PE34287	48	34	PE34469	Web		PE34689	71	10
PE33686	Web		PE34185	Web		PE34289	48	35	PE34470	Web		PE34690	Web	
PE33688	Web		PE34186	31	2	PE34291	Web		PE34471	Web		PE34692	Web	
PE33690	57	5	PE34188	31	3	PE34292	35	37	PE34472	Web		PE34693	Web	
PE33692	Web		PE34191	31	6	PE34293	Web		PE34473	Web		PE34694	71	11
PE33700	Web		PE34192	35	27	PE34296	Web		PE34474	Web		PE34696	Web	
PE33701	54	6	PE34193	31	7	PE34297	Web		PE34475	Web		PE34701	71	12
PE33704	61	13	PE34194	Web		PE34299	35	28	PE34476	Web		PE34703	71	13
PE33706	69	5	PE34195	32	17	PE34300	Web		PE34477	Web		PE34705	71	14
PE33720	Web		PE34196	49	10	PE34305	Web		PE34478	Web		PE34709	36	8
PE33728	Web		PE34197	Web		PE34307	Web		PE34479	Web		PE34716	Web	
PE33749	Web		PE34198	49	8	PE34309	Web		PE34480	Web		PE34721	56	19
PE33753	Web		PE34199	Web		PE34311	35	30	PE34481	Web		PE34727	44	8
PE33759	Web		PE34200	Web		PE34313	35	29	PE34482	Web		PE34729	Web	
PE33762	46	9	PE34201	49	3	PE34315	Web		PE34483	Web		PE34731	Web	
PE33778	Web		PE34202	32	14	PE34316	53	5	PE34484	Web		PE34733	45	8
PE33789	36	13	PE34203	48	6	PE34317	Web		PE34485	61	21	PE34735	45	10
PE33799	54	14	PE34204	Web		PE34319	Web		PE34486	Web		PE34737	45	9
PE33825	Web		PE34205	Web		PE34321	Web		PE34487	62	7	PE34739	Web	
PE33837	Web		PE34206	Web		PE34323	44	12	PE34488	Web		PE34741	45	15
PE33844	38	8	PE34207	48	7	PE34327	34	11	PE34489	62	4	PE34743	45	14
PE33864	36	9	PE34208	35	9	PE34351	Web		PE34490	Web		PE34745	45	12
PE33867	Web		PE34209	Web		PE34357	51	3	PE34491	Web		PE34747	45	16
PE33889	Web		PE34210	Web		PE34359	51	4	PE34492	56	21	PE34749	45	13
PE33896	Web		PE34211	Web		PE34360	Web		PE34493	61	22	PE34764	40	17
PE33927	Web		PE34212	Web		PE34361	44	9	PE34494	Web		PE34770	Web	
PE33928	38	27	PE34213	35	10	PE34374	40	2	PE34495	61	23	PE34777	40	5
PE33929	38	3	PE34214	Web		PE34388	65	5	PE34496	Web		PE34801	50	15
PE33938	58	15	PE34215	Web		PE34396	39	9	PE34497	Web		PE34833	35	35
PE33948	38	23	PE34216	Web		PE34397	39	8	PE34498	Web		PE34834	35	43
PE33964	35	36	PE34217	Web		PE34398	34	12	PE34499	Web		PE34835	35	41
PE33969	54	5	PE34218	49	36	PE34405	35	39	PE34500	Web		PE34836	35	42
PE33974	49	19	PE34219	Web		PE34406	38	28	PE34501	Web		PE34853	39	6
PE33977	49	33	PE34220	Web		PE34407	Web		PE34502	Web		PE34854	39	7
PE33984	Web		PE34221	Web		PE34408	Web		PE34503	57	2	PE34856	56	6
PE33989	42	4	PE34222	Web		PE34409	Web		PE34504	Web		PE34858	Web	
PE33996	38	7	PE34223	Web		PE34410	Web		PE34505	Web		PE34860	Web	
PE34008	42	5	PE34224	Web		PE34411	68	22	PE34506	54	3	PE34862	56	8
PE34023	Web		PE34225	Web		PE34412	Web		PE34507	Web		PE34864	Web	
PE34035	65	17	PE34226	33	10	PE34413	Web		PE34508	Web		PE34866	Web	
PE34061	35	26	PE34227	49	39	PE34414	38	29	PE34509	Web		PE34879	59	12
PE34069	40	1	PE34228	Web		PE34415	Web		PE34510	Web		PE34881	60	5
PE34070	36	10	PE34229	Web		PE34416	Web		PE34511	Web		PE34882	Web	
PE34071	36	14	PE34230	33	12	PE34417	Web		PE34512	Web		PE34883	60	6
PE34078	57	12	PE34231	49	22	PE34418	Web		PE34518	Web		PE34885	60	2
PE34098	Web		PE34233	33	7	PE34419	68	21	PE34520	Web		PE34887	40	3
PE34116	34	9	PE34234	Web		PE34420	Web		PE34532	Web		PE34889	60	7
PE34122	40	4	PE34235	33	13	PE34421	69	10	PE34534	67	26	PE34891	60	3
PE34134	Web		PE34236	49	26	PE34422	Web		PE34536	67	23	PE34893	Web	
PE34135	Web		PE34237	33	14	PE34423	Web		PE34538	Web		PE34895	60	8
PE34138	47	21	PE34238	Web		PE34424	69	13	PE34554	50	16	PE34917	35	38
PE34140	Web		PE34240	60	4	PE34425	68	17	PE34570	Web		PE34957	Web	
PE34141	Web		PE34241	Web		PE34427	68	12	PE34572	45	4	PE34966	Web	
PE34142	47	20	PE34243	Web		PE34428	69	3	PE34573	50	17	PE35021	Web	
PE34143	Web		PE34244	Web		PE34429	Web		PE34574	Web		PE35028	21	6
PE34144	Web		PE34245	33	34	PE34430	69	6	PE34575	Web		PE35064	36	18
PE34146	Web		PE34246	38	21	PE34431	Web		PE34576	Web		PE35100	53	10
PE34148	Web		PE34247	Web		PE34432	69	11	PE34577	Web		PE35108	36	17
PE34149	47	16	PE34248	Web		PE34433	68	15	PE34578	Web		PE35109	42	6
PE34150	49	12	PE34249	33	35	PE34434	Web		PE34579	Web		PE35110	36	21
PE34151	Web		PE34250	Web		PE34435	Web		PE34580	Web		PE35112	36	20
PE34152	Web		PE34252	34	4	PE34436	58	16	PE34581	Web		PE35114	Web	
PE34153	Web		PE34253	38	22	PE34437	69	19	PE34582	Web		PE35116	36	22
PE34154	Web		PE34254	34	5	PE34438	Web		PE34583	Web		PE35118	36	23
PE34155	Web		PE34255	Web		PE34439	Web		PE34584	Web		PE35121	Web	
PE34156	Web		PE34256	34	6	PE34440	Web		PE34585	Web		PE35148	Web	
PE34157	Web		PE34257	Web		PE34441	Web		PE34586	Web		PE35154	Web	
PE34158	Web		PE34259	Web		PE34442	Web		PE34587	55	26	PE35207	44	16
PE34159	Web		PE34261	Web		PE34443	Web		PE34588	Web		PE35208	Web	
PE34160	Web		PE34263	37	13	PE34445	58	1	PE34589	55	30	PE35209	44	17
PE34161	Web		PE34265	37	16	PE34447	58	2	PE34590	Web		PE35210	Web	
PE34162	Web		PE34266	Web		PE34448	Web		PE34591	Web		PE35211	44	18
PE34163	38	6	PE34268	37	12	PE34449	Web		PE34592	Web		PE35212	34	13
PE34164	65	19	PE34269	61	14	PE34450	Web		PE34593	67	19	PE35213	Web	
PE34166	Web		PE34270	37	17	PE34451	Web		PE34595	Web		PE35214	44	14
PE34168	Web		PE34271	53	17	PE34452	40	16	PE34597	67	21	PE35215	Web	
PE34169	37	27	PE34272	50	5	PE34453	Web		PE34598	60	1	PE35216	44	15
PE34170	Web		PE34273	Web		PE34454	39	18	PE34599	Web		PE35217	Web	
PE34171	37	30	PE34274	Web		PE34455	40	6	PE34600	Web		PE35218	Web	
PE34173	Web		PE34275	Web		PE34456	39	17	PE34602	Web		PE35219	Web	
PE34174	37	31	PE34276	Web		PE34458	39	15	PE34604	Web		PE35220	Web	
PE34175	Web		PE34277	Web		PE34459	Web		PE34614	34	10	PE35221	44	10
PE34176	Web		PE34279	53	16	PE34460	Web		PE34626	50	20	PE35222	Web	
PE34177	Web		PE34280	Web		PE34461	Web		PE34666	Web		PE35223	Web	

Appendix

# PART NUMBER INDEX

Note: C/R stands for the Column and/or Row location of the specific product on a given page.

Model No.	Page	C/R	Model No.	Page	C/R	Model No.	Page	C/R	Model No.	Page	C/R	Model No.	Page	C/R
PE35224	Web		PE35672	Web		PE36168	39	24	PE37844	68	7	PE38322	60	9
PE35225	Web		PE35711	Web		PE36169	Web		PE37845	68	8	PE38343	70	13
PE35226	Web		PE35729	Web		PE36170	51	2	PE37846	Web		PE38344	66	18
PE35227	44	11	PE35784	30	24	PE36171	Web		PE37847	Web		PE38407	Web	
PE35228	53	27	PE35785	50	12	PE36172	Web		PE37848	Web		PE38433	Web	
PE35229	54	17	PE35789	Web		PE36173	Web		PE37849	Web		PE38436	51	5
PE35230	53	28	PE35799	Web		PE36174	Web		PE37850	52	5	PE38446	Web	
PE35231	Web		PE35874	Web		PE36178	Web		PE37851	52	9	PE38447	58	22
PE35232	Web		PE35886	53	11	PE36181	Web		PE37859	Web		PE38448	58	21
PE35233	Web		PE35900	55	3	PE36200	Web		PE37885	Web		PE38449	Web	
PE35234	Web		PE35952	19	10	PE36201	Web		PE37900	Web		PE38450	51	11
PE35235	Web		PE35953	Web		PE36219	65	13	PE37908	30	23	PE38451	51	12
PE35236	53	29	PE35954	19	5	PE36228	36	7	PE37940	47	9	PE38452	51	10
PE35237	Web		PE35955	Web		PE36273	46	23	PE37941	47	10	PE38453	51	13
PE35238	53	30	PE35956	21	7	PE36283	Web		PE37942	47	12	PE38454	Web	
PE35239	Web		PE35957	Web		PE36344	Web		PE37943	47	14	PE38455	52	6
PE35240	Web		PE35958	21	4	PE36345	Web		PE37944	48	11	PE38456	Web	
PE35241	Web		PE35959	Web		PE36362	Web		PE37945	48	12	PE38457	Web	
PE35242	Web		PE35962	Web		PE36417	33	31	PE37946	48	13	PE38485	Web	
PE35243	Web		PE35963	Web		PE36455	Web		PE37947	48	14	PE38486	Web	
PE35244	Web		PE35964	Web		PE36475	32	11	PE37948	48	28	PE38487	Web	
PE35245	50	18	PE35965	Web		PE36507	Web		PE37949	48	29	PE38488	Web	
PE35246	39	10	PE35981	37	9	PE36519	46	7	PE37950	48	30	PE38489	51	14
PE35247	50	19	PE35991	Web		PE36520	57	21	PE37951	48	31	PE38490	51	17
PE35249	50	21	PE35997	53	9	PE36521	46	6	PE37952	55	5	PE38491	51	15
PE35256	Web		PE36058	38	24	PE36522	57	22	PE37953	Web		PE38492	51	16
PE35269	52	4	PE36065	52	3	PE36523	Web		PE37954	55	6	PE38493	Web	
PE35283	Web		PE36066	65	12	PE36524	57	23	PE37955	55	7	PE38494	52	8
PE35284	50	22	PE36067	Web		PE36525	Web		PE37956	Web		PE38495	Web	
PE35347	35	3	PE36068	Web		PE36526	57	24	PE37957	Web		PE38496	52	7
PE35348	69	33	PE36072	44	13	PE36527	Web		PE37958	Web		PE38502	59	7
PE35349	Web		PE36108	41	6	PE36528	Web		PE37959	Web		PE38506	66	32
PE35350	69	36	PE36109	Web		PE36529	Web		PE37960	Web		PE38574	Web	
PE35351	Web		PE36110	Web		PE36530	Web		PE37961	Web		PE38584	Web	
PE35352	69	34	PE36111	Web		PE36531	Web		PE37962	55	13	PE38624	32	12
PE35353	Web		PE36112	Web		PE36532	Web		PE37963	55	14	PE38628	30	25
PE35354	Web		PE36113	Web		PE36533	Web		PE37968	47	19	PE38632	55	23
PE35355	Web		PE36114	Web		PE36534	Web		PE37969	48	33	PE38638	33	4
PE35356	69	35	PE36115	Web		PE36535	Web		PE37970	48	15	PE38642	38	25
PE35357	Web		PE36116	Web		PE36536	Web		PE37971	55	8	PE38645	37	10
PE35358	69	37	PE36117	Web		PE36537	Web		PE37972	55	15	PE38670	Web	
PE35359	Web		PE36118	Web		PE36538	57	25	PE37973	55	12	PE38672	49	11
PE35360	Web		PE36119	Web		PE36539	Web		PE37980	50	14	PE38674	56	2
PE35361	Web		PE36120	Web		PE36540	57	26	PE37995	Web		PE38679	Web	
PE35362	69	38	PE36121	Web		PE36541	Web		PE38004	Web		PE38699	49	31
PE35363	Web		PE36122	Web		PE36542	57	27	PE38004/BK	71	15	PE38700	41	9
PE35364	Web		PE36123	Web		PE36555	53	8	PE38004/BL	71	15	PE38719	Web	
PE35365	Web		PE36124	Web		PE36569	Web		PE38004/GR	71	15	PE38746A	64	6
PE35366	Web		PE36125	Web		PE36570	Web		PE38004/RD	71	15	PE38746B	64	6
PE35367	Web		PE36126	Web		PE36571	Web		PE38004/WH	71	15	PE38746C	64	6
PE35368	Web		PE36127	71	2	PE36572	Web		PE38004/YW	71	15	PE38746D	64	6
PE35369	Web		PE36128	Web		PE36573	Web		PE38052	43	5	PE38746H	64	6
PE35370	70	1	PE36129	Web		PE36574	Web		PE38059	Web		PE38746I	64	6
PE35371	Web		PE36130	Web		PE36589	46	21	PE38093	43	1	PE38746K	64	6
PE35373	Web		PE36131	Web		PE36634	47	11	PE38116	39	22	PE38746Z	64	6
PE35375	Web		PE36132	70	7	PE36657	55	11	PE38135/BK	71	16	PE38747A	63	10
PE35384	69	7	PE36134	55	2	PE36661	41	15	PE38135/BL	71	16	PE38747B	63	10
PE35404	36	3	PE36135	70	8	PE36674	23	3	PE38135/GR	71	16	PE38747C	63	10
PE35418	19	2	PE36136	Web		PE36676	23	5	PE38135/RD	71	16	PE38747D	63	10
PE35419	19	6	PE36137	70	11	PE36678	23	6	PE38135/WH	71	16	PE38747H	63	10
PE35420	21	2	PE36138	Web		PE36689	Web		PE38135/YW	71	16	PE38747I	63	10
PE35421	19	8	PE36139	70	12	PE36690	Web		PE38139	Web		PE38747K	63	10
PE35422	19	7	PE36140	Web		PE36738	60	10	PE38141	Web		PE38747Z	63	10
PE35423	19	11	PE36141	70	9	PE36779	Web		PE38157	Web		PE38748A	63	13
PE35424	21	5	PE36142	Web		PE36799	60	13	PE38161	58	19	PE38748B	63	13
PE35430	36	27	PE36143	70	10	PE36848	38	26	PE38184	36	6	PE38748C	63	13
PE35463	Web		PE36144	Web		PE36910	49	30	PE38194	Web		PE38748D	63	13
PE35475	19	3	PE36145	70	14	PE36958	50	13	PE38204	Web		PE38748H	63	13
PE35508	Web		PE36146	58	25	PE36963	Web		PE38231	Web		PE38748I	63	13
PE35522	47	13	PE36147	Web		PE37099	61	3	PE38240	Web		PE38748K	63	13
PE35527	Web		PE36148	58	23	PE37120	39	11	PE38249	Web		PE38748Z	63	13
PE35571	Web		PE36149	70	15	PE37137	Web		PE38270	58	18	PE38749A	64	3
PE35575	44	4	PE36150	58	26	PE37163	70	6	PE38271	58	17	PE38749B	64	3
PE35580	66	6	PE36151	70	16	PE37250	63	5	PE38272	58	20	PE38749C	64	3
PE35591	23	1	PE36152	58	24	PE37357	Web		PE38273	39	20	PE38749D	64	3
PE35606	23	2	PE36153	70	17	PE37401	Web		PE38274	39	21	PE38749H	64	3
PE35611	23	4	PE36154	59	1	PE37450	Web		PE38275	39	19	PE38749I	64	3
PE35635	54	13	PE36155	71	1	PE37478	Web		PE38276	43	4	PE38749K	64	3
PE35639	46	1	PE36156	58	27	PE37536	62	23	PE38277	43	3	PE38749Z	64	3
PE35652	45	22	PE36157	Web		PE37563	Web		PE38278	43	6	PE38750A	64	4
PE35654	46	3	PE36158	59	2	PE37580	Web		PE38295	59	3	PE38750B	64	4
PE35656	Web		PE36159	Web		PE37594	Web		PE38296	59	11	PE38750C	64	4
PE35658	46	2	PE36160	58	28	PE37600	Web		PE38297	43	14	PE38750D	64	4
PE35660	45	19	PE36161	Web		PE37640	67	11	PE38298	59	4	PE38750H	64	4
PE35662	Web		PE36162	39	25	PE37782	Web		PE38299	44	1	PE38750I	64	4
PE35664	45	18	PE36163	Web		PE37808	72	2	PE38300	45	1	PE38750K	64	4
PE35666	36	26	PE36164	39	23	PE37840	42	7	PE38301	45	2	PE38750Z	64	4
PE35668	Web		PE36165	Web		PE37841	43	13	PE38302	59	9	PE38751A	63	8
PE35670	Web		PE36166	39	26	PE37842	56	7	PE38303	55	1	PE38751B	63	8
PE35671	52	20	PE36167	Web		PE37843	56	9	PE38304	54	10	PE38751C	63	8

# PART NUMBER INDEX

Note: C/R stands for the Column and/or Row location of the specific product on a given page.

Model No.	Page	C/R	Model No.	Page	C/R	Model No.	Page	C/R	Model No.	Page	C/R	Model No.	Page	C/R
PE38751D	63	8	PE39199Z	41	3	PE39422	25	22	PE300010	Web		PE4047	98	11
PE38751H	63	8	PE39229	69	14	PE39423	24		PE300011	Web		PE4048	94	27
PE38751I	63	8	PE39255	54	4	PE39424	25	8	PE300012	Web		PE4049	121	36
PE38751K	63	8	PE39342A	41	2	PE39425	25	4	PE300013	Web		PE4051	104	15
PE38751Z	63	8	PE39342B	41	2	PE39426	25	12	PE300014	Web		PE4052	113	1
PE38752A	63	11	PE39342C	41	2	PE39427	25	16	PE300015	Web		PE4053	119	48
PE38752B	63	11	PE39342D	41	2	PE39428	25	20	PE300016	Web		PE4054	98	35
PE38752C	63	11	PE39342H	41	2	PE39429	24		PE300017	Web		PE4055	122	1
PE38752D	63	11	PE39342I	41	2	PE39430	25	5	PE300018	Web		PE4056	120	32
PE38752H	63	11	PE39342K	41	2	PE39431	25	1	PE300019	Web		PE4057	120	17
PE38752I	63	11	PE39342Z	41	2	PE39432	25	9	PE300020	Web		PE4058	120	16
PE38752K	63	11	PE39343A	41	1	PE39433	25	13	PE300021	Web		PE4059	96	16
PE38752Z	63	11	PE39343B	41	1	PE39434	25	17	PE300022	Web		PE4060	96	51
PE38753A	64	1	PE39343C	41	1	PE39435	25	23	PE300023	Web		PE4061	96	12
PE38753B	64	1	PE39343D	41	1	PE39436	25	21	PE300024	Web		PE4062	95	19
PE38753C	64	1	PE39343H	41	1	PE39437	24		PE300025	Web		PE4063	100	23
PE38753D	64	1	PE39343I	41	1	PE39438	25	7	PE300026	Web		PE4064	100	29
PE38753H	64	1	PE39343K	41	1	PE39439	25	3	PE300027	Web		PE4065	100	22
PE38753I	64	1	PE39343Z	41	1	PE39440	25	11	PE300028	Web		PE4066	99	19
PE38753K	64	1	PE39344A	43	9	PE39441	25	15	PE300029	Web		PE4067	98	21
PE38753Z	64	1	PE39344B	43	9	PE39442	25	19	PE300030	Web		PE4068	99	5
PE38754A	64	5	PE39344C	43	9	PE39443	26	2	PE300031	Web		PE4069	102	23
PE38754B	64	5	PE39344D	43	9	PE39444	27	6	PE300032	Web		PE4070	120	7
PE38754C	64	5	PE39344H	43	9	PE39445	27	2	PE300033	Web		PE4071	98	10
PE38754D	64	5	PE39344I	43	9	PE39446	27	10	PE300034	Web		PE4072	96	14
PE38754H	64	5	PE39344K	43	9	PE39447	27	14	PE300035	Web		PE4073	102	24
PE38754I	64	5	PE39344Z	43	9	PE39448	27	18	PE300107	Web		PE4074	104	9
PE38754K	64	5	PE39345A	43	7	PE39449	27	24	PE300109	Web		PE4075	123	5
PE38754Z	64	5	PE39345B	43	7	PE39450	27	22	PE300111	Web		PE4076	123	9
PE38755A	63	9	PE39345C	43	7	PE39451	26	4	PE300121	Web		PE4077	121	35
PE38755B	63	9	PE39345D	43	7	PE39452	27	8	PE300131	Web		PE4078	120	30
PE38755C	63	9	PE39345H	43	7	PE39453	27	4	PE300133	Web		PE4079	120	6
PE38755D	63	9	PE39345I	43	7	PE39454	27	12	PE300200	Web		PE4080	112	20
PE38755H	63	9	PE39345K	43	7	PE39455	27	16	PE300300	Web		PE4081	95	21
PE38755I	63	9	PE39345Z	43	7	PE39456	27	20	PE300408	Web		PE4082	121	32
PE38755K	63	9	PE39346A	43	8	PE39457	26	1	PE300418	Web		PE4083	83	54
PE38755Z	63	9	PE39346B	43	8	PE39458	27	5	PE300420	Web		PE4084	119	28
PE38756A	63	12	PE39346C	43	8	PE39459	27	1	PE300432	Web		PE4085	83	16
PE38756B	63	12	PE39346D	43	8	PE39460	27	9	PE300509	Web		PE4088	98	20
PE38756C	63	12	PE39346H	43	8	PE39461	27	13	PE300511	Web		PE4089	135	5
PE38756D	63	12	PE39346I	43	8	PE39462	27	17	PE300521	Web		PE4091	121	37
PE38756H	63	12	PE39346K	43	8	PE39463	27	23	PE300531	Web		PE4092	120	1
PE38756I	63	12	PE39346Z	43	8	PE39464	27	21	PE300533	Web		PE4093	123	4
PE38756K	63	12	PE39347A	41	5	PE39465	26	3	PE4000	87	27	PE4094	104	22
PE38756Z	63	12	PE39347B	41	5	PE39466	27	7	PE4001	87	12	PE4095	104	27
PE38757A	64	2	PE39347C	41	5	PE39467	27	3	PE4002	83	43	PE4096	113	8
PE38757B	64	2	PE39347D	41	5	PE39468	27	11	PE4003	83	5	PE4097	113	13
PE38757C	64	2	PE39347H	41	5	PE39469	27	15	PE4004	87	17	PE4098	123	10
PE38757D	64	2	PE39347I	41	5	PE39470	27	19	PE4005	83	29	PE4099	87	20
PE38757H	64	2	PE39347K	41	5	PE39471	28	2	PE4006	95	11	PE4100	124	9
PE38757I	64	2	PE39347Z	41	5	PE39472	29	6	PE4007	83	33	PE4101	87	5
PE38757K	64	2	PE39348A	41	4	PE39473	29	2	PE4008	83	11	PE4102	120	2
PE38757Z	64	2	PE39348B	41	4	PE39474	29	10	PE4009	83	40	PE4104	134	8
PE38804	Web		PE39348C	41	4	PE39475	29	14	PE4010	122	2	PE4105	134	10
PE38813	51	18	PE39348D	41	4	PE39476	29	18	PE4011	122	5	PE4106	120	20
PE38830	Web		PE39348H	41	4	PE39477	29	24	PE4012	103	5	PE4107	105	3
PE38857	56	10	PE39348I	41	4	PE39478	29	22	PE4013	97	25	PE4108	83	45
PE38858	56	11	PE39348K	41	4	PE39479	28	4	PE4014	121	34	PE4109	119	30
PE38881	39	27	PE39348Z	41	4	PE39480	29	8	PE4015	121	33	PE4110	131	18
PE38889	59	8	PE39349A	43	12	PE39481	29	4	PE4016	119	15	PE4112	83	28
PE38890	59	6	PE39349B	43	12	PE39482	29	12	PE4017	114	11	PE4113	96	32
PE38920	35	4	PE39349C	43	12	PE39483	29	16	PE4018	119	16	PE4114	96	37
PE38930	59	10	PE39349D	43	12	PE39484	29	20	PE4019	114	12	PE4115	84	21
PE38934	Web		PE39349H	43	12	PE39485	28	1	PE4020	102	28	PE4116	84	22
PE38997	Web		PE39349I	43	12	PE39486	29	5	PE4021	103	2	PE4117	86	33
PE39035	57	20	PE39349K	43	12	PE39487	29	1	PE4022	103	1	PE4118	86	34
PE39078	59	5	PE39349Z	43	12	PE39488	29	9	PE4023	119	31	PE4119	84	44
PE39082	50	1	PE39350A	43	10	PE39489	29	13	PE4024	119	32	PE4120	84	43
PE39087	30	8	PE39350B	43	10	PE39490	29	17	PE4025	83	55	PE4121	85	4
PE39108	66	7	PE39350C	43	10	PE39491	29	23	PE4026	83	18	PE4122	85	5
PE39120	Web		PE39350D	43	10	PE39492	29	21	PE4027	83	22	PE4123	87	38
PE39138	Web		PE39350H	43	10	PE39493	28	3	PE4028	83	47	PE4124	86	28
PE39143	Web		PE39350I	43	10	PE39494	29	7	PE4029	83	48	PE4125	86	26
PE39148	Web		PE39350K	43	10	PE39495	29	3	PE4030	84	14	PE4126	86	27
PE39185	Web		PE39350Z	43	10	PE39496	29	11	PE4031	84	15	PE4127	86	25
PE39197A	40	18	PE39351A	43	11	PE39497	29	15	PE4032	84	36	PE4128	87	14
PE39197B	40	18	PE39351B	43	11	PE39498	29	19	PE4033	84	37	PE4129	95	12
PE39197C	40	18	PE39351C	43	11	PE39564	Web		PE4034	85	1	PE4130	96	5
PE39197D	40	18	PE39351D	43	11	PE39802	55	9	PE4035	85	2	PE4131	97	14
PE39197H	40	18	PE39351H	43	11	PE39803	55	10	PE4036	83	30	PE4132	95	23
PE39197I	40	18	PE39351I	43	11	PE300000	Web		PE4037	83	32	PE4133	95	5
PE39197K	40	18	PE39351K	43	11	PE300001	Web		PE4038	84	1	PE4134	95	54
PE39197Z	40	18	PE39351Z	43	11	PE300002	Web		PE4039	84	2	PE4135	95	43
PE39199A	41	3	PE39415	24		PE300003	Web		PE4040	84	24	PE4136	95	42
PE39199B	41	3	PE39416	25	6	PE300004	Web		PE4041	84	25	PE4137	97	17
PE39199C	41	3	PE39417	25	2	PE300005	Web		PE4042	94	30	PE4138	96	4
PE39199D	41	3	PE39418	25	10	PE300006	Web		PE4043	119	11	PE4139	97	15
PE39199H	41	3	PE39419	25	14	PE300007	Web		PE4044	119	19	PE4140	95	26
PE39199I	41	3	PE39420	25	18	PE300008	Web		PE4045	104	8	PE4141	96	50
PE39199K	41	3	PE39421	25	24	PE300009	Web		PE4046	112	19	PE4142	98	17

Appendix



# PART NUMBER INDEX

Note: C/R stands for the Column and/or Row location of the specific product on a given page.

Model No.	Page	C/R	Model No.	Page	C/R	Model No.	Page	C/R	Model No.	Page	C/R	Model No.	Page	C/R
PE4143	98	16	PE4234	135	6	PE4324	135	12	PE4414	84	7	PE4504	126	5
PE4144	99	1	PE4235	135	8	PE4325	84	6	PE4415	84	11	PE4505	126	6
PE4145	98	42	PE4236	135	7	PE4326	84	9	PE4416	84	4	PE4506	126	7
PE4146	98	34	PE4237	135	9	PE4327	83	42	PE4417	84	16	PE4507	125	30
PE4147	99	18	PE4238	135	11	PE4328	97	23	PE4418	84	19	PE4508	125	26
PE4148	99	17	PE4239	124	15	PE4329	94	28	PE4419	84	32	PE4509	125	29
PE4149	99	12	PE4240	125	17	PE4330	96	15	PE4420	84	30	PE4510	125	25
PE4150	99	11	PE4241	125	21	PE4331	95	22	PE4421	84	35	PE4511	125	28
PE4151	99	8	PE4242	124	28	PE4332	83	21	PE4422	84	28	PE4512	125	24
PE4152	99	15	PE4243	124	26	PE4333	124	7	PE4423	84	45	PE4513	125	27
PE4153	99	10	PE4244	124	34	PE4334	114	13	PE4424	84	34	PE4514	126	4
PE4154	98	22	PE4245	113	27	PE4335	114	14	PE4425	84	26	PE4515	126	3
PE4155	99	4	PE4246	105	8	PE4336	114	15	PE4426	84	38	PE4516	126	2
PE4156	98	9	PE4247	119	8	PE4337	114	16	PE4427	84	29	PE4517	124	21
PE4157	130	13	PE4248	130	11	PE4338	114	17	PE4428	84	48	PE4518	124	19
PE4158	127	2	PE4249	127	1	PE4339	114	18	PE4429	94	24	PE4519	106	24
PE4159	113	2	PE4250	112	25	PE4340	115	1	PE4430	94	26	PE4520	106	22
PE4160	104	16	PE4251	131	1	PE4341	115	2	PE4431	95	4	PE4521	103	8
PE4161	131	3	PE4252	127	6	PE4342	103	7	PE4432	94	29	PE4522	113	3
PE4162	127	7	PE4253	131	7	PE4343	124	4	PE4433	95	20	PE4523	112	21
PE4163	131	8	PE4254	127	10	PE4344	94	16	PE4434	95	10	PE4524	89	5
PE4164	127	11	PE4255	131	12	PE4345	119	43	PE4435	95	51	PE4525	88	14
PE4165	131	13	PE4256	127	15	PE4346	134	9	PE4436	95	53	PE4526	88	15
PE4166	127	16	PE4257	130	17	PE4347	134	11	PE4437	96	11	PE4527	87	30
PE4167	113	22	PE4258	127	5	PE4348	119	3	PE4438	95	50	PE4528	87	8
PE4168	131	20	PE4259	127	4	PE4349	124	2	PE4439	96	3	PE4529	87	4
PE4169	127	22	PE4260	113	6	PE4350	123	3	PE4440	96	28	PE4530	87	10
PE4170	113	21	PE4261	113	7	PE4351	119	14	PE4441	96	34	PE4531	86	24
PE4171	105	2	PE4262	104	20	PE4352	119	1	PE4442	96	25	PE4532	87	9
PE4172	131	19	PE4263	104	21	PE4353	84	47	PE4443	96	33	PE4533	87	19
PE4173	127	21	PE4264	131	6	PE4354	86	23	PE4444	97	24	PE4534	86	30
PE4174	114	7	PE4265	131	5	PE4355	97	22	PE4445	124	22	PE4535	86	31
PE4175	105	14	PE4266	127	9	PE4356	112	23	PE4446	98	7	PE4536	87	3
PE4176	128	1	PE4267	127	8	PE4357	104	12	PE4447	98	8	PE4537	87	28
PE4177	114	8	PE4268	113	11	PE4358	113	5	PE4448	98	19	PE4538	87	25
PE4178	105	17	PE4269	113	12	PE4359	104	19	PE4449	98	13	PE4539	87	21
PE4179	131	24	PE4270	104	25	PE4360	113	10	PE4450	98	31	PE4540	87	31
PE4180	128	2	PE4271	104	26	PE4361	104	24	PE4451	98	29	PE4541	86	29
PE4181	123	20	PE4272	131	11	PE4362	113	17	PE4452	98	36	PE4542	88	21
PE4182	107	21	PE4273	131	10	PE4363	104	31	PE4453	98	30	PE4543	88	22
PE4183	108	6	PE4274	127	14	PE4364	113	14	PE4454	98	32	PE4544	86	22
PE4184	93	9	PE4275	127	13	PE4365	104	28	PE4455	98	28	PE4545	89	6
PE4186	87	23	PE4276	113	18	PE4366	113	26	PE4456	98	33	PE4546	87	22
PE4187	84	33	PE4277	113	19	PE4367	105	7	PE4457	98	41	PE4547	84	49
PE4188	84	46	PE4278	104	32	PE4368	131	22	PE4458	98	39	PE4548	85	3
PE4189	87	2	PE4279	104	33	PE4369	127	24	PE4459	98	40	PE4549	87	7
PE4190	86	32	PE4280	131	16	PE4370	87	15	PE4460	99	6	PE4550	94	17
PE4191	95	52	PE4281	131	15	PE4371	96	29	PE4461	99	2	PE4551	111	5
PE4192	107	14	PE4282	127	19	PE4372	96	1	PE4462	98	38	PE4552	111	4
PE4193	123	33	PE4283	127	18	PE4373	123	19	PE4463	99	3	PE4553	111	10
PE4194	124	3	PE4284	113	23	PE4374	125	11	PE4464	99	16	PE4554	111	11
PE4195	119	42	PE4285	105	4	PE4375	124	20	PE4465	99	9	PE4555	112	13
PE4196	84	50	PE4286	131	21	PE4376	95	25	PE4466	99	7	PE4556	112	15
PE4197	84	51	PE4287	127	23	PE4377	119	33	PE4467	99	14	PE4557	104	17
PE4198	107	22	PE4288	113	20	PE4378	119	13	PE4468	100	27	PE4558	104	10
PE4199	93	10	PE4289	105	1	PE4379	119	20	PE4469	100	25	PE4559	112	9
PE4200	112	24	PE4290	131	17	PE4380	119	25	PE4470	100	21	PE4560	112	2
PE4201	104	13	PE4291	127	20	PE4381	119	17	PE4471	100	28	PE4561	112	1
PE4202	104	14	PE4292	131	23	PE4382	119	18	PE4472	130	15	PE4562	111	16
PE4203	130	18	PE4293	127	25	PE4383	119	24	PE4473	107	15	PE4563	107	5
PE4204	120	11	PE4294	83	10	PE4384	119	29	PE4474	107	16	PE4564	107	6
PE4205	120	12	PE4295	102	21	PE4385	119	5	PE4475	107	19	PE4565	107	8
PE4206	119	26	PE4296	83	38	PE4386	119	21	PE4476	107	20	PE4566	101	22
PE4207	119	27	PE4297	96	38	PE4387	119	46	PE4477	107	18	PE4567	101	20
PE4208	120	22	PE4298	119	41	PE4388	119	45	PE4478	107	17	PE4568	101	9
PE4209	120	24	PE4299	123	8	PE4389	120	14	PE4479	107	23	PE4569	101	8
PE4210	119	9	PE4300	87	11	PE4390	120	4	PE4480	108	3	PE4570	101	6
PE4211	121	31	PE4301	135	4	PE4391	120	28	PE4481	108	5	PE4571	101	7
PE4212	120	15	PE4302	98	6	PE4392	120	18	PE4482	95	34	PE4572	102	17
PE4213	83	31	PE4303	98	18	PE4393	119	40	PE4483	95	35	PE4573	102	19
PE4214	83	19	PE4304	99	13	PE4394	122	4	PE4484	95	37	PE4574	102	18
PE4215	83	8	PE4305	100	24	PE4395	122	3	PE4485	95	36	PE4575	101	39
PE4216	87	24	PE4306	100	26	PE4396	119	39	PE4486	97	27	PE4576	83	14
PE4217	87	26	PE4307	119	44	PE4397	120	9	PE4487	97	26	PE4577	83	13
PE4218	87	29	PE4308	120	8	PE4398	83	6	PE4488	97	16	PE4578	83	7
PE4219	87	6	PE4309	120	23	PE4399	83	20	PE4489	97	10	PE4579	83	46
PE4220	87	36	PE4310	120	31	PE4400	83	15	PE4490	97	11	PE4580	83	39
PE4221	95	17	PE4311	123	35	PE4401	83	2	PE4491	97	13	PE4581	84	41
PE4222	95	27	PE4312	123	34	PE4402	83	23	PE4492	97	21	PE4582	83	35
PE4223	96	36	PE4313	123	32	PE4403	83	17	PE4493	123	2	PE4583	83	12
PE4224	95	18	PE4314	123	31	PE4404	83	26	PE4494	123	7	PE4584	83	34
PE4225	123	21	PE4315	124	13	PE4405	83	41	PE4495	123	36	PE4585	84	12
PE4226	123	13	PE4316	124	8	PE4406	83	56	PE4496	124	1	PE4586	84	23
PE4227	123	14	PE4317	122	6	PE4407	83	44	PE4497	124	5	PE4587	112	22
PE4228	123	37	PE4318	121	38	PE4408	83	37	PE4498	124	6	PE4588	104	11
PE4229	108	4	PE4319	120	27	PE4409	83	49	PE4499	124	16	PE4589	113	4
PE4230	108	2	PE4320	119	47	PE4410	83	52	PE4500	124	17	PE4590	104	18
PE4231	106	20	PE4321	120	13	PE4411	84	13	PE4501	124	18	PE4591	132	30
PE4232	106	19	PE4322	107	4	PE4412	84	10	PE4502	126	1	PE4592	132	26
PE4233	119	2	PE4323	107	7	PE4413	84	8	PE4503	126	8	PE4593	132	29

# PART NUMBER INDEX

Note: C/R stands for the Column and/or Row location of the specific product on a given page.

Model No.	Page	C/R	Model No.	Page	C/R	Model No.	Page	C/R	Model No.	Page	C/R	Model No.	Page	C/R
PE4600	132	25	PE4690	99	48	PE4780	85	28	PE4871	88	3	PE4964	125	5
PE4601	132	28	PE4691	100	5	PE4781	85	25	PE4872	89	11	PE4965	125	7
PE4602	132	22	PE4692	100	3	PE4782	85	33	PE4873	89	7	PE4966	125	9
PE4603	132	27	PE4693	100	4	PE4783	85	24	PE4874	89	8	PE4967	125	12
PE4604	132	20	PE4694	100	18	PE4784	85	26	PE4875	89	12	PE4968	125	10
PE4605	133	8	PE4695	100	13	PE4785	85	22	PE4876	111	8	PE4969	125	13
PE4606	133	7	PE4696	100	11	PE4786	85	31	PE4877	111	14	PE4970	125	14
PE4607	133	6	PE4697	100	19	PE4787	85	27	PE4878	111	3	PE4971	125	20
PE4608	133	4	PE4698	100	12	PE4788	85	23	PE4879	111	9	PE4972	125	18
PE4609	133	5	PE4699	100	17	PE4789	85	32	PE4880	111	6	PE4973	125	19
PE4610	133	3	PE4700	100	10	PE4790	85	29	PE4881	111	7	PE4974	119	34
PE4611	133	15	PE4701	100	16	PE4791	85	30	PE4882	111	12	PE4975	98	23
PE4612	133	14	PE4702	100	14	PE4792	85	42	PE4883	111	13	PE4976	106	21
PE4613	133	13	PE4703	100	15	PE4793	85	39	PE4884	111	17	PE4977	106	23
PE4614	133	11	PE4704	100	31	PE4794	85	47	PE4885	111	15	PE4978	107	2
PE4615	133	12	PE4705	100	34	PE4795	85	38	PE4886	111	20	PE4979	107	1
PE4616	133	10	PE4706	100	32	PE4796	85	40	PE4887	111	19	PE4980	107	3
PE4617	134	1	PE4707	100	33	PE4797	85	36	PE4888	111	18	PE4981	90	34
PE4618	134	4	PE4708	100	30	PE4798	85	45	PE4889	112	12	PE4982	90	35
PE4619	133	30	PE4709	123	12	PE4799	85	37	PE4890	112	14	PE4983	91	1
PE4620	133	29	PE4710	123	11	PE4800	118	12	PE4891	112	4	PE4984	91	2
PE4621	133	31	PE4711	120	44	PE4801	118	9	PE4892	112	11	PE4985	91	3
PE4622	133	35	PE4712	120	34	PE4802	118	10	PE4893	112	10	PE4986	91	4
PE4623	133	26	PE4713	120	35	PE4803	118	11	PE4894	112	3	PE4987	91	5
PE4624	133	32	PE4714	120	45	PE4804	118	20	PE4895	112	5	PE4988	91	6
PE4625	133	28	PE4715	120	38	PE4805	118	17	PE4896	110	8	PE4989	91	7
PE4626	133	34	PE4716	120	36	PE4806	118	18	PE4897	110	9	PE4990	91	10
PE4627	133	27	PE4717	120	46	PE4807	118	19	PE4898	110	13	PE4992	91	11
PE4628	134	5	PE4718	120	37	PE4808	117	11	PE4899	110	14	PE4993	132	1
PE4629	133	33	PE4719	120	42	PE4809	117	8	PE4900	110	16	PE4994	132	2
PE4630	134	2	PE4720	120	33	PE4810	117	9	PE4901	110	17	PE4995	132	4
PE4631	134	3	PE4721	120	43	PE4811	117	10	PE4902	110	18	PE4996	132	5
PE4632	120	29	PE4722	120	40	PE4812	117	19	PE4903	111	2	PE4997	132	11
PE4633	132	16	PE4723	120	47	PE4813	117	16	PE4904	111	1	PE4998	132	12
PE4634	132	17	PE4724	120	41	PE4814	117	17	PE4905	110	23	PE44000	90	22
PE4635	133	24	PE4725	120	48	PE4815	117	18	PE4906	127	17	PE44001	90	24
PE4636	133	23	PE4726	120	39	PE4816	118	25	PE4907	83	27	PE44002	90	26
PE4637	133	22	PE4727	121	6	PE4817	118	22	PE4908	119	35	PE44003	90	28
PE4638	133	20	PE4728	121	8	PE4818	118	23	PE4909	98	24	PE44004	90	30
PE4639	133	21	PE4729	121	3	PE4819	118	24	PE4910	88	23	PE44005	90	7
PE4640	133	19	PE4730	121	2	PE4820	118	33	PE4911	88	26	PE44006	90	9
PE4641	133	17	PE4731	121	7	PE4821	118	30	PE4912	88	13	PE44007	90	10
PE4642	133	18	PE4732	121	4	PE4822	118	31	PE4913	88	12	PE44008	90	13
PE4643	119	12	PE4733	121	1	PE4823	118	32	PE4914	84	31	PE44009	90	14
PE4644	103	18	PE4734	121	5	PE4824	117	24	PE4915	120	25	PE44010	90	21
PE4645	96	10	PE4735	121	17	PE4825	117	21	PE4916	120	26	PE44011	90	23
PE4646	96	13	PE4736	121	19	PE4826	117	22	PE4917	83	25	PE44012	90	25
PE4647	94	25	PE4737	121	12	PE4827	117	23	PE4918	83	24	PE44013	90	27
PE4648	98	25	PE4738	121	10	PE4828	118	7	PE4919	83	51	PE44014	90	29
PE4649	98	26	PE4739	121	11	PE4829	118	4	PE4920	83	50	PE44015	90	31
PE4650	119	36	PE4740	121	18	PE4830	118	5	PE4921	84	18	PE44016	90	32
PE4651	119	37	PE4741	121	15	PE4831	118	6	PE4922	84	17	PE44017	90	33
PE4652	96	18	PE4742	121	9	PE4832	118	37	PE4923	84	40	PE44018	90	6
PE4653	96	19	PE4743	121	16	PE4833	118	35	PE4924	84	39	PE44019	90	8
PE4654	96	40	PE4744	121	13	PE4834	118	38	PE4925	131	14	PE44020	90	11
PE4655	96	41	PE4745	121	14	PE4835	118	36	PE4926	113	9	PE44021	90	12
PE4656	125	23	PE4746	121	29	PE4837	118	13	PE4927	104	23	PE44022	90	15
PE4657	123	6	PE4747	121	23	PE4838	118	21	PE4928	131	9	PE44023	90	16
PE4658	127	3	PE4748	121	21	PE4839	118	15	PE4929	127	12	PE44024	90	17
PE4659	99	33	PE4749	121	28	PE4840	118	16	PE4930	84	20	PE44025	90	18
PE4660	99	23	PE4750	121	22	PE4841	118	14	PE4931	84	42	PE44026	90	19
PE4661	99	24	PE4751	121	26	PE4842	117	12	PE4932	83	53	PE44027	90	20
PE4662	99	34	PE4752	121	20	PE4843	117	20	PE4933	123	1	PE44028	90	1
PE4663	99	27	PE4753	121	27	PE4844	117	14	PE4934	95	24	PE44029	90	2
PE4664	99	25	PE4754	121	24	PE4845	117	15	PE4935	95	39	PE44030	90	3
PE4665	99	35	PE4755	121	25	PE4846	117	13	PE4936	95	44	PE44031	90	4
PE4666	99	26	PE4756	122	14	PE4847	118	26	PE4937	95	45	PE44032	90	5
PE4667	99	31	PE4757	122	10	PE4848	118	34	PE4938	95	38	PE44033	118	29
PE4668	99	22	PE4758	122	9	PE4849	118	28	PE4939	95	28	PE44034	118	27
PE4669	99	32	PE4759	122	12	PE4850	85	41	PE4940	96	26	PE44035	117	25
PE4670	99	29	PE4760	122	15	PE4851	85	46	PE4941	96	27	PE44036	118	8
PE4671	99	36	PE4761	122	7	PE4852	85	43	PE4942	96	31	PE44037	118	2
PE4672	99	30	PE4762	122	8	PE4853	85	44	PE4943	96	30	PE44038	118	3
PE4673	99	37	PE4763	122	13	PE4854	85	54	PE4944	96	20	PE44039	118	1
PE4674	99	28	PE4764	122	11	PE4855	85	51	PE4945	96	17	PE44040	119	22
PE4675	99	42	PE4765	121	30	PE4856	86	5	PE4946	96	39	PE44041	119	7
PE4676	99	44	PE4766	85	16	PE4857	85	50	PE4949	124	31	PE44042	119	23
PE4677	99	40	PE4767	85	12	PE4858	85	52	PE4950	124	25	PE44043	95	6
PE4678	99	39	PE4768	85	21	PE4859	85	48	PE4951	124	23	PE44044	94	19
PE4679	99	45	PE4769	85	11	PE4860	86	3	PE4952	124	29	PE44045	95	7
PE4680	99	43	PE4770	85	13	PE4861	85	53	PE4953	124	24	PE44046	95	8
PE4681	99	38	PE4771	85	8	PE4862	85	49	PE4954	124	27	PE44047	104	30
PE4682	99	41	PE4772	85	19	PE4863	86	4	PE4955	124	30	PE44048	113	16
PE4683	100	6	PE4773	85	14	PE4864	86	1	PE4957	124	35	PE44049	124	11
PE4684	100	8	PE4774	85	9	PE4865	86	2	PE4958	124	33	PE44050	102	26
PE4685	100	2	PE4775	85	20	PE4866	88	6	PE4959	124	32	PE44051	102	22
PE4686	99	49	PE4776	85	15	PE4867	88	5	PE4960	125	2	PE44052	102	27
PE4687	100	1	PE4777	85	10	PE4868	88	4	PE4961	125	3	PE44053	102	25
PE4688	100	9	PE4778	85	17	PE4869	89	9	PE4962	125	4	PE44054	102	20
PE4689	100	7	PE4779	85	18	PE4870	89	10	PE4963	125	1	PE44055	102	31



# PART NUMBER INDEX

Note: C/R stands for the Column and/or Row location of the specific product on a given page.

Model No.	Page	C/R	Model No.	Page	C/R	Model No.	Page	C/R	Model No.	Page	C/R	Model No.	Page	C/R
PE44056	102	32	PE44149	104	7	PE44257	117	1	PE44348	109	26	PE44449	107	11
PE44057	102	30	PE44161	126	16	PE44258	117	3	PE44349	95	9	PE44450	107	12
PE44058	102	29	PE44162	126	12	PE44259	117	2	PE44350	96	2	PE44451	107	13
PE44059	103	4	PE44163	126	15	PE44260	116	27	PE44351	106	1	PE44452	128	5
PE44060	103	3	PE44164	126	11	PE44261	116	26	PE44352	106	2	PE44453	110	12
PE44061	98	14	PE44165	126	14	PE44262	129	5	PE44353	106	3	PE44454	94	22
PE44062	98	5	PE44166	126	10	PE44263	129	6	PE44354	106	4	PE44455	114	19
PE44063	98	12	PE44167	126	13	PE44264	129	7	PE44355	106	5	PE44456	110	11
PE44064	98	15	PE44168	126	9	PE44265	129	8	PE44356	106	6	PE44457	110	15
PE44065	96	42	PE44169	126	20	PE44266	129	9	PE44357	106	15	PE44458	110	20
PE44066	96	43	PE44170	126	19	PE44267	129	10	PE44358	106	16	PE44459	110	19
PE44068	96	45	PE44171	126	18	PE44268	129	11	PE44359	106	17	PE44460	83	9
PE44069	96	44	PE44172	126	17	PE44269	129	12	PE44360	106	18	PE44470	97	1
PE44070	96	49	PE44173	126	24	PE44270	129	13	PE44361	106	7	PE44471	97	5
PE44071	96	46	PE44174	126	23	PE44271	129	14	PE44362	106	8	PE44472	97	2
PE44072	96	47	PE44175	126	22	PE44272	109	19	PE44363	106	9	PE44473	97	4
PE44073	96	48	PE44176	126	21	PE44273	109	18	PE44364	106	10	PE44474	97	3
PE44074	97	29	PE44177	126	25	PE44274	109	21	PE44365	106	11	PE44475	97	9
PE44075	97	28	PE44178	126	28	PE44275	109	22	PE44366	106	12	PE44476	97	8
PE44076	97	30	PE44180	126	26	PE44276	101	19	PE44367	106	13	PE44477	97	7
PE44077	97	20	PE44181	126	27	PE44277	101	21	PE44368	106	14	PE44478	97	6
PE44078	97	18	PE44182	86	9	PE44278	101	13	PE44369	111	21	PE44480	109	25
PE44079	97	19	PE44183	86	8	PE44279	101	14	PE44370	111	22	PE44481	109	24
PE44080	124	12	PE44184	86	6	PE44280	101	30	PE44371	111	23	PE44482	109	23
PE44081	103	11	PE44185	86	7	PE44281	101	31	PE44372	111	24	PE44483	109	17
PE44082	103	10	PE44186	86	13	PE44282	101	29	PE44373	111	25	PE44484	7	22
PE44083	103	14	PE44187	86	12	PE44283	102	8	PE44374	111	26	PE44485	7	23
PE44084	103	13	PE44188	86	10	PE44284	101	38	PE44375	112	16	PE44486	7	24
PE44085	103	12	PE44189	86	11	PE44285	102	9	PE44376	112	18	PE44487	7	25
PE44086	103	16	PE44190	86	17	PE44286	101	41	PE44377	112	17	PE44488	7	26
PE44087	103	15	PE44191	86	16	PE44287	101	40	PE44378	93	13	PE44489	110	6
PE44088	103	9	PE44192	86	14	PE44288	102	7	PE44379	93	3	PE44490	110	5
PE44089	103	17	PE44193	86	15	PE44289	102	1	PE44380	93	14	PE44491	110	1
PE44090	103	6	PE44194	86	21	PE44290	102	2	PE44381	93	4	PE44492	110	2
PE44091	103	19	PE44195	86	20	PE44291	102	16	PE44382	93	11	PE44493	110	3
PE44092	103	20	PE44196	86	18	PE44292	102	15	PE44383	93	8	PE44494	110	4
PE44093	124	10	PE44197	86	19	PE44293	98	4	PE44384	93	18	PE44495	108	11
PE44094	113	15	PE44198	88	7	PE44294	119	6	PE44385	93	22	PE44496	108	10
PE44095	104	29	PE44199	88	8	PE44295	104	2	PE44386	93	23	PE44497	108	17
PE44096	125	16	PE44200	88	9	PE44296	104	3	PE44387	93	27	PE44498	108	16
PE44097	125	15	PE44201	89	14	PE44297	104	1	PE44388	93	31	PE44499	108	22
PE44098	125	8	PE44202	89	13	PE44298	130	1	PE44389	93	32	PE44500	108	21
PE44099	125	6	PE44203	83	4	PE44299	130	2	PE44390	93	36	PE44501	108	8
PE44100	123	17	PE44204	88	18	PE44300	130	3	PE44391	94	14	PE44502	108	7
PE44102	123	15	PE44205	88	20	PE44301	130	4	PE44392	94	8	PE44503	108	9
PE44103	123	16	PE44206	88	16	PE44302	130	8	PE44393	94	7	PE44504	108	13
PE44104	123	18	PE44207	88	17	PE44303	130	9	PE44394	94	12	PE44505	108	12
PE44105	123	26	PE44208	88	19	PE44304	130	10	PE44395	94	10	PE44506	108	14
PE44106	123	28	PE44209	88	11	PE44305	130	7	PE44396	97	32	PE44507	108	19
PE44107	123	24	PE44210	88	10	PE44306	130	5	PE44397	98	1	PE44508	108	18
PE44108	123	22	PE44211	89	1	PE44307	130	6	PE44398	98	2	PE44509	108	20
PE44109	123	27	PE44212	89	4	PE44308	117	6	PE44401	93	19	PE44510	108	23
PE44110	123	23	PE44213	89	2	PE44309	117	4	PE44402	93	20	PE44511	108	25
PE44111	123	25	PE44214	89	3	PE44310	117	5	PE44403	93	28	PE44512	108	24
PE44112	123	30	PE44215	92	2	PE44311	117	7	PE44404	93	29	PE44513	108	26
PE44113	123	29	PE44216	92	3	PE44312	128	10	PE44405	93	37	PE44515	108	15
PE44114	135	10	PE44217	92	10	PE44313	128	4	PE44406	93	38	PE44520	94	18
PE44115	136	1	PE44218	92	12	PE44314	128	14	PE44416	93	2	PE44521	94	20
PE44116	136	2	PE44219	92	14	PE44315	128	9	PE44417	93	5	PE44522	94	21
PE44117	125	22	PE44220	92	6	PE44316	128	7	PE44418	93	12	PE44523	94	23
PE44118	124	14	PE44221	92	8	PE44317	128	8	PE44419	93	15	PE44524	95	30
PE44119	114	5	PE44222	92	13	PE44318	128	13	PE44420	93	16	PE44525	95	31
PE44120	105	13	PE44223	92	5	PE44319	128	6	PE44421	93	17	PE44526	95	32
PE44121	114	6	PE44224	92	7	PE44320	128	15	PE44422	93	21	PE44527	95	33
PE44122	105	15	PE44225	92	9	PE44321	128	18	PE44423	93	24	PE44528	96	21
PE44123	114	9	PE44226	92	11	PE44322	128	16	PE44424	93	25	PE44529	96	22
PE44124	105	18	PE44227	91	8	PE44323	128	19	PE44425	93	26	PE44530	96	23
PE44125	132	13	PE44228	91	9	PE44324	128	20	PE44426	93	30	PE44531	96	24
PE44126	114	10	PE44229	91	17	PE44325	128	22	PE44427	93	33	PE44532	95	46
PE44127	105	16	PE44230	91	18	PE44326	128	21	PE44428	93	34	PE44533	95	47
PE44128	132	14	PE44231	91	16	PE44327	128	24	PE44429	93	35	PE44534	95	48
PE44129	114	4	PE44232	91	14	PE44329	128	26	PE44430	94	13	PE44535	95	49
PE44130	105	12	PE44233	91	15	PE44330	128	25	PE44431	94	5	PE44536	101	2
PE44131	132	10	PE44234	91	13	PE44331	129	1	PE44432	94	6	PE44537	101	3
PE44132	114	1	PE44235	88	24	PE44332	129	3	PE44433	94	9	PE44538	101	4
PE44133	105	9	PE44236	87	37	PE44333	129	2	PE44434	94	11	PE44539	101	5
PE44134	132	9	PE44237	87	35	PE44334	129	4	PE44435	94	15	PE44540	101	23
PE44135	114	3	PE44238	87	34	PE44335	92	15	PE44436	94	1	PE44541	101	24
PE44136	105	11	PE44239	87	33	PE44336	92	16	PE44437	94	2	PE44542	101	25
PE44137	114	2	PE44240	88	2	PE44337	93	1	PE44438	94	3	PE44543	101	26
PE44138	105	10	PE44241	88	1	PE44338	92	17	PE44439	94	4	PE44544	101	34
PE44139	113	24	PE44242	116	19	PE44339	92	18	PE44440	93	6	PE44545	101	35
PE44140	105	5	PE44243	116	18	PE44340	87	18	PE44441	93	7	PE44546	101	36
PE44141	132	8	PE44244	116	17	PE44341	87	16	PE44442	130	16	PE44547	101	37
PE44142	113	25	PE44247	116	22	PE44342	88	25	PE44443	130	12	PE44548	102	10
PE44143	105	6	PE44248	116	21	PE44343	87	13	PE44444	130	14	PE44549	102	11
PE44145	135	3	PE44249	116	20	PE44344	87	1	PE44445	131	2	PE44550	102	12
PE44146	104	5	PE44254	116	23	PE44345	92	1	PE44446	131	4	PE44551	102	13
PE44147	104	6	PE44255	116	24	PE44346	92	4	PE44447	107	10	PE44552	95	13
PE44148	104	4	PE44256	116	25	PE44347	91	12	PE44448	107	9	PE44553	95	16

# PART NUMBER INDEX

Note: C/R stands for the Column and/or Row location of the specific product on a given page.

Model No.	Page	C/R	Model No.	Page	C/R	Model No.	Page	C/R	Model No.	Page	C/R	Model No.	Page	C/R
PE44554	95	40	PE44647H	115	7	PE5510	6	3	PE51086	222	8	PE6061	195	24
PE44555	96	6	PE44647I	115	8	PE5511	6	4	PE51087	223	3	PE6062	195	9
PE44556	96	9	PE44647K	115	9	PE5512	6	5	PE51088	221	17	PE6063	195	13
PE44557	101	15	PE44647Z	115	10	PE5513	6	6	PE51089	221	1	PE6064	195	26
PE44558	101	18	PE44648A	115	19	PE5514	6	7	PE51090	222	9	PE6065	195	11
PE44559	101	27	PE44648B	115	20	PE5515	6	8	PE51093	223	14	PE6066	195	15
PE44560	102	3	PE44648C	115	21	PE51000	220	1	PE51095	222	16	PE6067	197	14
PE44561	102	6	PE44648D	115	22	PE51001	220	2	PE51096	224	2	PE6068	197	16
PE44562	95	14	PE44648H	115	23	PE51002	220	3	PE51097	224	8	PE6069	195	2
PE44563	95	15	PE44648I	115	24	PE51003	220	5	PE51098	224	3	PE6070	195	4
PE44564	95	41	PE44648K	115	25	PE51004	220	4	PE51106	223	9	PE6071	196	5
PE44565	96	7	PE44648Z	115	26	PE51005	220	6	PE51110	221	18	PE6072	196	6
PE44566	96	8	PE44649A	115	27	PE51006	220	7	PE51113	220	15	PE6073	196	9
PE44567	101	16	PE44649B	115	28	PE51007	220	8	PE51116	219	1	PE6074	196	10
PE44568	101	17	PE44649C	115	29	PE51008	220	10	PE51117	221	10	PE6075	196	32
PE44569	101	28	PE44649D	115	30	PE51009	220	13	PE51118	221	11	PE6076	196	34
PE44570	102	4	PE44649H	115	31	PE51010	220	14	PE51119	221	8	PE6077	196	7
PE44571	102	5	PE44649I	115	32	PE51011	227	1	PE51120	221	9	PE6078	196	8
PE44572	128	12	PE44649K	115	33	PE51012	227	2	PE51121	221	12	PE6079	196	11
PE44573	128	11	PE44649Z	115	34	PE51013	220	11	PE51122	221	13	PE6080	196	12
PE44574	134	15	PE44650A	116	9	PE51014	220	12	PE51123	221	14	PE6081	196	22
PE44575	134	16	PE44650B	116	10	PE51016	225	3	PE51124	221	15	PE6082	196	23
PE44576	134	14	PE44650C	116	11	PE51017	219	5	PE51125	222	1	PE6083	196	24
PE44577	133	2	PE44650D	116	12	PE51018	222	10	PE51126	222	2	PE6084	196	25
PE44578	133	1	PE44650H	116	13	PE51019	226	5	PE51127	222	3	PE6085	195	5
PE44579	128	17	PE44650I	116	14	PE51020	230	2	PE51128	222	4	PE6086	195	6
PE44580	135	1	PE44650K	116	15	PE51021	230	1	PE51129	224	12	PE6088	195	7
PE44581	133	9	PE44650Z	116	16	PE51022	230	3	PE51130	224	9	PE6089	196	37
PE44582	128	3	PE44651A	116	1	PE51023	226	1	PE51131	224	10	PE6090	196	38
PE44583	134	12	PE44651B	116	2	PE51024	226	2	PE51132	224	11	PE6091	196	39
PE44584	132	15	PE44651C	116	3	PE51025	226	3	PE51133	221	16	PE6092	196	40
PE44585	128	23	PE44651D	116	4	PE51026	222	6	PE51134	221	23	PE6093	197	25
PE44586	135	2	PE44651H	116	5	PE51027	219	2	PE51135	221	24	PE6094	197	27
PE44587	133	16	PE44651I	116	6	PE51028	219	3	PE51136	220	20	PE6095	196	43
PE44588	132	3	PE44651K	116	7	PE51029	219	6	PE6000	195	23	PE6096	196	44
PE44589	132	6	PE44651Z	116	8	PE51030	219	7	PE6001	195	8	PE6097	196	45
PE44590	132	7	PE44652	133	25	PE51031	219	8	PE6002	195	1	PE6098	196	46
PE44592	108	1	PE44653	97	12	PE51032	219	12	PE6003	195	3	PE6099	196	47
PE44593	87	32	PE44654	100	20	PE51033	219	13	PE6006	205	9	PE6100	196	49
PE44594	110	7	PE44655	109	20	PE51034	219	14	PE6007	205	11	PE6101	196	60
PE44595	109	4	PE44656	102	14	PE51035	219	16	PE6008	198	3	PE6102	196	54
PE44596	109	3	PE44657	84	27	PE51036	219	17	PE6009	196	31	PE6103	196	52
PE44597	109	1	PE44658	120	21	PE51037	219	18	PE6011	195	12	PE6104	196	55
PE44598	109	2	PE44659	101	1	PE51038	219	19	PE6012	205	21	PE6105	196	57
PE44599	109	5	PE44660	112	7	PE51039	219	20	PE6013	205	2	PE6106	196	62
PE44600	109	9	PE44661	112	6	PE51040	219	21	PE6014	205	1	PE6107	196	64
PE44601	109	8	PE44662	110	22	PE51041	226	10	PE6015	205	4	PE6108	205	3
PE44602	109	6	PE44663	110	21	PE51042	226	4	PE6016	204	11	PE6109	205	5
PE44603	109	7	PE44664	85	6	PE51043	226	12	PE6017	204	10	PE6110	205	8
PE44604	109	10	PE44665	85	34	PE51044	226	16	PE6018	204	13	PE6111	205	7
PE44605	109	14	PE44666	85	7	PE51045	226	17	PE6019	204	6	PE6112	197	4
PE44606	109	13	PE44667	85	35	PE51046	226	13	PE6020	204	9	PE6113	204	27
PE44607	109	11	PE44668	83	3	PE51047	226	14	PE6021	204	17	PE6114	204	30
PE44608	109	12	PE44669	84	5	PE51048	226	15	PE6022	205	13	PE6115	204	29
PE44609	109	15	PE44670	99	20	PE51049	226	11	PE6023	204	15	PE6116	204	12
PE44610	109	16	PE44671	99	46	PE51050	226	19	PE6024	204	5	PE6117	204	25
PE44613	112	8	PE44672	99	21	PE51051	226	20	PE6026	198	4	PE6118	204	26
PE44615	97	31	PE44673	99	47	PE51052	226	21	PE6027	195	25	PE6119	204	8
PE44616	122	16	PE44674	120	10	PE51053	226	18	PE6028	195	10	PE6120	204	7
PE44618	122	17	PE44675	95	29	PE51054	225	13	PE6029	195	14	PE6121	204	31
PE44619	134	6	PE44676	120	3	PE51055	222	5	PE6030	205	23	PE6122	204	33
PE44620	134	7	PE44686	119	10	PE51056	221	7	PE6031	205	15	PE6123	204	22
PE44622	134	13	PE44687	120	19	PE51057	223	15	PE6032	196	33	PE6124	204	24
PE44625	132	18	PE44688	120	5	PE51058	224	1	PE6033	198	5	PE6125	204	32
PE44629	132	21	PE44726	95	1	PE51059	223	16	PE6034	196	59	PE6126	204	23
PE44630	132	19	PE44727	95	55	PE51060	220	9	PE6035	196	53	PE6127	205	22
PE44631	132	23	PE44728	101	10	PE51061	219	9	PE6036	196	51	PE6128	205	24
PE44632	132	24	PE44729	95	3	PE51062	219	4	PE6037	196	63	PE6129	205	14
PE44633	96	35	PE44731	95	57	PE51063	219	10	PE6038	196	61	PE6130	205	16
PE44634	98	3	PE44732	101	12	PE51064	219	11	PE6039	197	3	PE6131	205	10
PE44635	98	27	PE44734	101	33	PE51065	219	15	PE6040	197	1	PE6132	205	12
PE44636	98	37	PE44735	95	2	PE51066	225	12	PE6041	197	11	PE6133	205	17
PE44637	83	1	PE44737	95	56	PE51067	225	2	PE6042	197	8	PE6134	205	18
PE44638	83	36	PE44738	101	11	PE51068	225	11	PE6043	197	6	PE6135	205	19
PE44639	84	3	PE44740	101	32	PE51069	225	1	PE6044	195	21	PE6136	205	20
PE44640	119	4	PE5001	239	10	PE51070	223	8	PE6045	195	22	PE6137	197	10
PE44641	119	38	PE5004	239	12	PE51071	223	4	PE6046	205	6	PE6138	196	48
PE44645	110	10	PE5006	239	9	PE51072	223	5	PE6047	197	13	PE6139	196	50
PE44646A	115	11	PE5007	239	11	PE51073	222	11	PE6048	197	15	PE6140	196	56
PE44646B	115	12	PE5008	240	1	PE51074	222	7	PE6049	195	17	PE6141	196	58
PE44646C	115	13	PE5009	240	2	PE51076	222	12	PE6050	195	18	PE6142	198	2
PE44646D	115	14	PE5010	240	4	PE51077	222	13	PE6051	197	24	PE6143	204	16
PE44646H	115	15	PE5011	239	2	PE51078	222	14	PE6052	197	26	PE6144	204	14
PE44646I	115	16	PE5012	240	3	PE51079	222	15	PE6053	197	21	PE6145	195	27
PE44646K	115	17	PE5014	239	1	PE51080	222	17	PE6054	197	22	PE6146	195	16
PE44646Z	115	18	PE5200	238	8	PE51081	222	18	PE6055	197	19	PE6147	195	28
PE44647A	115	3	PE5500	6	9	PE51082	223	1	PE6056	197	20	PE6148	196	1
PE44647B	115	4	PE5500-KIT	6	1	PE51083	223	2	PE6057	204	18	PE6149	196	2
PE44647C	115	5	PE5501	6	13	PE51084	223	6	PE6058	204	19	PE6150	196	3
PE44647D	115	6	PE5501-KIT	6	2	PE51085	223	7	PE6059	204	28	PE6151	196	4

# PART NUMBER INDEX

Note: C/R stands for the Column and/or Row location of the specific product on a given page.

Model No.	Page	C/R	Model No.	Page	C/R	Model No.	Page	C/R	Model No.	Page	C/R	Model No.	Page	C/R
PE6152	196	28	PE7029	191	47	PE7132	217	29	PE8225	206	1	PE8724	207	19
PE6153	196	29	PE7030	188	18	PE7133	217	30	PE8226	206	2	PE8725	207	24
PE6154	196	30	PE7031	191	45	PE7134	217	31	PE8227	206	3	PE8726	207	20
PE6155	196	41	PE7032	191	46	PE7135	217	32	PE8231	206	24	PE8727	207	21
PE6156	196	42	PE7033	192	56	PE7136	217	33	PE8232	206	25	PE9000	172	C1
PE6157	196	35	PE7034	192	53	PE7137	217	34	PE8233	206	26	PE9001	172	D3
PE6158	196	36	PE7035	193	59	PE7138	217	35	PE8234	206	18	PE9002	161	A6
PE6159	197	23	PE7036	193	61	PE7139	210	3	PE8235	206	19	PE9003	172	C4
PE6160	196	21	PE7037	193	60	PE7140	210	4	PE8236	206	20	PE9004	165	D6
PE6161	196	20	PE7038	193	62	PE7141	216	7	PE8237	206	4	PE9005	162	A1
PE6162	195	20	PE7039	188	21	PE7142	216	6	PE8238	206	5	PE9006	158	D3
PE6163	195	19	PE7040	189	25	PE7143	216	9	PE8239	206	6	PE9007	157	C6
PE6164	196	19	PE7041	189	32	PE7144	216	8	PE8240	206	21	PE9008	173	C5
PE6165	197	12	PE7042	190	36	PE7145	216	11	PE8241	206	22	PE9009	173	D4
PE6166	197	5	PE7043	190	40	PE7146	216	10	PE8242	206	23	PE9011	173	A5
PE6167	197	2	PE7044	191	49	PE7147	216	14	PE8243	209	7	PE9013	173	A6
PE6168	197	7	PE7045	186	10	PE7148	216	13	PE8244	209	8	PE9063	148	D3
PE6169	197	9	PE7046	185	1	PE7149	216	15	PE8245	209	9	PE9064	160	A3
PE6173	196	13	PE7047	187	15	PE7150	216	24	PE8246	209	10	PE9065	166	D2
PE6174	196	14	PE7048	189	28	PE7151	216	25	PE8247	209	11	PE9066	166	A3
PE6175	196	15	PE7049	188	20	PE7152	216	26	PE8250	205	26	PE9067	147	D1
PE6176	196	26	PE7050	191	51	PE7153	216	27	PE8251	206	8	PE9068	146	A5
PE6177	196	27	PE7051	188	17	PE7154	216	20	PE8252	206	12	PE9069	146	D1
PE6178	196	16	PE7052	188	24	PE7155	216	21	PE8253	209	12	PE9070	146	C6
PE6179	196	17	PE7053	189	30	PE7156	216	22	PE8254	209	13	PE9071	147	A1
PE6180	196	18	PE7054	190	35	PE7157	216	23	PE8300	208	12	PE9072	152	C5
PE6800	233	9	PE7055	190	39	PE7158	216	17	PE8301	208	13	PE9073	152	C6
PE6801	233	8	PE7056	190	43	PE7159	216	18	PE8302	208	14	PE9074	152	A6
PE6802	233	7	PE7057	191	50	PE7160	216	19	PE8303	208	15	PE9075	153	A1
PE6803	233	6	PE7058	192	54	PE7161	185	2	PE8304	208	16	PE9076	149	A5
PE6804	233	5	PE7061	194	64	PE7162	186	9	PE8305	208	17	PE9077	149	B6
PE6805	233	4	PE7062	194	65	PE7300	210	1	PE8306	208	18	PE9078	149	C5
PE6806	233	3	PE7063	194	66	PE7301	210	2	PE8310	209	1	PE9079	149	D6
PE6807	233	1	PE7064	194	67	PE8000	213	15	PE8311	209	2	PE9080	148	A5
PE6808	233	2	PE7065	195	68	PE8001	214	1	PE8312	209	3	PE9081	149	B1
PE6809	232	17	PE7066	199	19	PE8002	214	3	PE8313	209	4	PE9082	148	B6
PE6810	232	16	PE7067	199	18	PE8003	214	5	PE8400	208	1	PE9083	149	A3
PE6811	232	15	PE7068	199	20	PE8004	214	7	PE8401	208	2	PE9084	172	C2
PE6812	232	14	PE7069	199	21	PE8005	214	9	PE8402	208	3	PE9085	172	B2
PE6813	232	13	PE7070	199	8	PE8006	214	11	PE8403	208	4	PE9086	158	C2
PE6814	232	12	PE7071	199	10	PE8007	214	13	PE8404	208	5	PE9087	172	C6
PE6815	232	11	PE7072	199	9	PE8008	214	15	PE8405	208	6	PE9088	164	B4
PE6816	232	9	PE7073	199	12	PE8009	214	17	PE8406	208	7	PE9089	159	D3
PE6817	232	10	PE7074	199	13	PE8010	213	8	PE8410	208	8	PE9090	159	A3
PE6818	233	18	PE7075	199	4	PE8011	213	9	PE8411	208	9	PE9091	162	B6
PE6819	233	17	PE7076	199	5	PE8012	213	10	PE8412	208	10	PE9093	172	D2
PE6820	233	16	PE7077	199	6	PE8013	213	11	PE8413	208	11	PE9094	165	D4
PE6821	233	15	PE7078	199	7	PE8014	213	12	PE8500	215	16	PE9095	165	B5
PE6822	233	14	PE7079	199	15	PE8015	213	13	PE8501	215	17	PE9096	165	B4
PE6823	233	13	PE7080	199	14	PE8016	213	14	PE8502	215	18	PE9097	164	A5
PE6824	233	12	PE7081	199	16	PE8017	214	20	PE8503	215	19	PE9098	164	D4
PE6825	233	10	PE7082	199	17	PE8018	214	21	PE8504	215	20	PE9099	163	A2
PE6826	233	11	PE7083	199	11	PE8019	214	22	PE8505	216	1	PE9100	163	B1
PE6827	234	9	PE7085	191	46	PE8020	214	23	PE8506	216	2	PE9101	158	B6
PE6828	234	8	PE7087	187	12	PE8021	214	24	PE8507	216	3	PE9102	158	D5
PE6829	234	7	PE7088	185	3	PE8022	214	25	PE8508	216	4	PE9103	146	D3
PE6830	234	6	PE7089	185	4	PE8023	214	26	PE8509	216	5	PE9104	149	A4
PE6831	234	5	PE7090	187	14	PE8024	215	1	PE8600	213	4	PE9105	148	C6
PE6832	234	4	PE7100	216	16	PE8025	215	2	PE8601	213	5	PE9106	172	C3
PE6833	234	3	PE7101	216	29	PE8026	215	3	PE8602	213	6	PE9107	166	A1
PE6834	234	1	PE7102	216	12	PE8027	215	4	PE8603	213	7	PE9108	167	B5
PE6835	234	2	PE7103	216	28	PE8028	215	5	PE8650	212	14	PE9109	172	B6
PE7000	186	7	PE7104	217	1	PE8029	215	6	PE8651	212	15	PE9110	164	A4
PE7001	186	8	PE7105	217	2	PE8030	215	7	PE8652	213	1	PE9111	160	B2
PE7002	185	5	PE7106	217	3	PE8031	215	8	PE8653	213	2	PE9112	160	C2
PE7003	185	6	PE7107	217	4	PE8032	215	9	PE8654	213	3	PE9113	160	A2
PE7004	187	16	PE7108	217	5	PE8033	215	10	PE8700	207	1	PE9114	165	A5
PE7005	186	11	PE7109	217	6	PE8034	215	11	PE8701	207	2	PE9115	167	D1
PE7006	199	2	PE7110	217	7	PE8035	215	12	PE8702	207	3	PE9116	171	D2
PE7007	199	3	PE7111	217	8	PE8036	215	13	PE8703	207	4	PE9117	167	A1
PE7008	192	52	PE7112	217	9	PE8037	215	14	PE8704	207	5	PE9118	171	B2
PE7009	191	48	PE7113	217	10	PE8038	215	15	PE8705	207	6	PE9119	167	B1
PE7010	189	27	PE7114	217	11	PE8040	214	19	PE8706	207	7	PE9120	171	C2
PE7011	194	63	PE7115	217	12	PE8200	209	5	PE8707	207	8	PE9121	167	A2
PE7013	188	22	PE7116	217	13	PE8202	209	6	PE8708	207	9	PE9122	171	A3
PE7014	188	23	PE7117	217	14	PE8210	205	25	PE8709	207	10	PE9123	162	B1
PE7015	189	29	PE7118	217	15	PE8211	205	27	PE8710	207	11	PE9124	162	B3
PE7016	189	26	PE7119	217	16	PE8212	205	28	PE8711	207	12	PE9125	160	D6
PE7017	190	34	PE7120	217	17	PE8213	206	7	PE8712	207	13	PE9126	169	C3
PE7018	189	33	PE7121	217	18	PE8214	206	9	PE8713	207	14	PE9127	161	B5
PE7019	190	38	PE7122	217	19	PE8215	206	10	PE8714	207	15	PE9128	158	A4
PE7020	190	37	PE7123	217	20	PE8216	206	15	PE8715	207	28	PE9129	169	D3
PE7021	190	42	PE7124	217	21	PE8217	206	16	PE8716	207	26	PE9130	159	C2
PE7022	190	41	PE7125	217	22	PE8218	206	17	PE8717	207	25	PE9131	159	D4
PE7023	188	19	PE7126	217	23	PE8219	206	11	PE8718	207	27	PE9132	171	B5
PE7024	187	13	PE7127	217	24	PE8220	206	13	PE8719	207	17	PE9135	171	C4
PE7025	189	31	PE7128	217	25	PE8221	206	14	PE8720	207	22	PE9136	171	C5
PE7026	190	44	PE7129	217	26	PE8222	205	29	PE8721	207	23	PE9137	171	D4
PE7027	198	8	PE7130	217	27	PE8223	205	30	PE8722	207	18	PE9138	167	D4
PE7028	199	1	PE7131	217	28	PE8224	205	31	PE8723	207	16	PE9139	167	B4



# PART NUMBER INDEX

Note: C/R stands for the Column and/or Row location of the specific product on a given page.

Model No.	Page	C/R	Model No.	Page	C/R	Model No.	Page	C/R	Model No.	Page	C/R	Model No.	Page	C/R
PE9140	167	A5	PE9241	171	A5	PE9334	157	C2	PE9424	153	D2	PE9515	158	B2
PE9141	167	C4	PE9242	167	C2	PE9335	174	C2	PE9425	153	C2	PE9516	170	B5
PE9142	152	B3	PE9243	171	C3	PE9336	174	B4	PE9426	158	A1	PE9517	170	C4
PE9143	152	C3	PE9244	177	B1	PE9337	174	A4	PE9427	157	A6	PE9518	170	A5
PE9144	152	D2	PE9245	178	B1	PE9338	174	D3	PE9428	158	D2	PE9519	170	D4
PE9145	152	A3	PE9246	147	D3	PE9339	174	A3	PE9429	158	C3	PE9520	171	D1
PE9146	151	A2	PE9247	147	B3	PE9340	174	B2	PE9430	148	D6	PE9521	164	D3
PE9147	151	B2	PE9248	178	A1	PE9341	166	D4	PE9431	148	C4	PE9522	170	A3
PE9148	151	C1	PE9249	174	C4	PE9342	166	C4	PE9432	149	B2	PE9523	170	D2
PE9149	151	D1	PE9250	157	B5	PE9343	166	C2	PE9433	148	B5	PE9524	170	A6
PE9150	173	C2	PE9251	150	A1	PE9344	165	A6	PE9434	149	D2	PE9525	170	D3
PE9151	173	D2	PE9252	149	B3	PE9345	163	B6	PE9435	149	D3	PE9526	170	B4
PE9152	173	B2	PE9253	151	A3	PE9346	163	C6	PE9436	154	A5	PE9527	170	C3
PE9153	173	A3	PE9254	151	C2	PE9347	166	B2	PE9437	154	C5	PE9528	170	A4
PE9154	163	B2	PE9255	151	B3	PE9348	165	D5	PE9438	154	A6	PE9529	172	A5
PE9155	162	D4	PE9256	151	D2	PE9349	162	B4	PE9439	149	D4	PE9530	172	D4
PE9158	173	C4	PE9257	162	B5	PE9350	162	C4	PE9440	149	A6	PE9531	163	B4
PE9159	177	A2	PE9258	162	C5	PE9351	157	C3	PE9441	149	B5	PE9532	163	A4
PE9160	177	C2	PE9259	153	D3	PE9352	157	A4	PE9442	149	C6	PE9533	147	C5
PE9163	177	A6	PE9260	153	A4	PE9353	157	D3	PE9443	162	D6	PE9534	147	B5
PE9164	177	B3	PE9261	162	B2	PE9354	157	B4	PE9444	163	D1	PE9535	159	B6
PE9165	166	C1	PE9262	146	C4	PE9355	157	C4	PE9445	162	A6	PE9536	172	A6
PE9166	177	D2	PE9263	159	A4	PE9356	157	D4	PE9446	159	B2	PE9537	172	D6
PE9167	166	D1	PE9264	169	A4	PE9357	157	D1	PE9447	159	C3	PE9538	162	A3
PE9168	177	B6	PE9265	174	D2	PE9358	157	A2	PE9448	159	D2	PE9539	162	A4
PE9169	173	B5	PE9266	174	A1	PE9359	158	A5	PE9449	159	B4	PE9540	162	C2
PE9171	173	B4	PE9267	174	B1	PE9360	161	B1	PE9450	159	C4	PE9541	158	B5
PE9172	172	B3	PE9268	174	C1	PE9361	178	A5	PE9451	155	C6	PE9542	164	A3
PE9173	158	D4	PE9269	172	A2	PE9362	178	B5	PE9452	155	D6	PE9543	164	D2
PE9174	172	A4	PE9270	163	C1	PE9363	178	C5	PE9453	156	A1	PE9544	164	C3
PE9175	173	D5	PE9271	177	D6	PE9364	178	D4	PE9454	155	D1	PE9545	164	B3
PE9178	159	D6	PE9272	176	C6	PE9365	178	B6	PE9455	155	C1	PE9546	146	A4
PE9179	160	B1	PE9273	146	A2	PE9366	178	D5	PE9456	155	A2	PE9547	158	D1
PE9180	160	D1	PE9274	147	B2	PE9367	178	A6	PE9457	155	B1	PE9548	158	D6
PE9181	168	A6	PE9275	149	A2	PE9368	176	D3	PE9458	156	D3	PE9549	158	C6
PE9182	147	C3	PE9276	150	B1	PE9369	176	C3	PE9459	156	A4	PE9550	159	B3
PE9183	160	B3	PE9277	160	B5	PE9370	176	B3	PE9460	155	B5	PE9551	149	D1
PE9184	147	C1	PE9278	161	C6	PE9371	176	A4	PE9461	155	C5	PE9552	159	B5
PE9185	153	B1	PE9279	179	A5	PE9372	163	A6	PE9462	161	D3	PE9553	161	C1
PE9186	174	D5	PE9280	179	C4	PE9373	179	A1	PE9463	161	C3	PE9554	160	C6
PE9187	148	C3	PE9281	167	B3	PE9374	179	B1	PE9464	161	B3	PE9555	164	D6
PE9188	148	A4	PE9282	167	D3	PE9375	179	D4	PE9465	161	A3	PE9556	165	C2
PE9189	157	A3	PE9283	167	A4	PE9376	179	D3	PE9466	171	C1	PE9557	165	B2
PE9191	157	C5	PE9284	167	C3	PE9377	179	A4	PE9467	171	A1	PE9558	165	A3
PE9192	157	D2	PE9285	179	B3	PE9378	179	B4	PE9468	171	B1	PE9559	165	B3
PE9193	169	A2	PE9286	179	A3	PE9379	147	A3	PE9469	170	D6	PE9560	162	C6
PE9194	161	A1	PE9287	163	C2	PE9380	146	D6	PE9470	152	B2	PE9561	163	A1
PE9195	163	A3	PE9288	163	D2	PE9381	146	B5	PE9471	152	A2	PE9562	164	C5
PE9196	160	A5	PE9289	163	C3	PE9382	158	C4	PE9472	152	D1	PE9563	164	A2
PE9198	157	D6	PE9290	163	B3	PE9383	158	B4	PE9473	152	C1	PE9564	164	D5
PE9199	178	D6	PE9291	163	D5	PE9384	149	D5	PE9474	170	B6	PE9565	161	C5
PE9200	168	B4	PE9292	160	C5	PE9385	160	D2	PE9475	152	A1	PE9566	162	C1
PE9201	165	C6	PE9293	174	B5	PE9386	169	A5	PE9476	151	C6	PE9567	169	B3
PE9204	173	A1	PE9294	174	B6	PE9387	169	B5	PE9477	152	B1	PE9568	168	A4
PE9205	169	C1	PE9295	162	D3	PE9388	161	B6	PE9478	151	D6	PE9569	168	A5
PE9206	162	A2	PE9296	169	C4	PE9389	162	A5	PE9479	170	D5	PE9570	160	D4
PE9207	174	A6	PE9297	172	D5	PE9390	158	C5	PE9480	170	C2	PE9571	168	C4
PE9208	174	C5	PE9298	160	B6	PE9391	175	B2	PE9481	158	A6	PE9572	168	C2
PE9209	165	C4	PE9299	160	D5	PE9392	171	D6	PE9482	159	A5	PE9573	168	B3
PE9210	168	D6	PE9300	174	A5	PE9393	171	B6	PE9483	164	B5	PE9574	169	B3
PE9211	174	D1	PE9301	174	D6	PE9394	172	A1	PE9484	172	B4	PE9575	169	D2
PE9212	169	D4	PE9302	171	A4	PE9395	171	C6	PE9485	147	D2	PE9576	169	B1
PE9213	157	A5	PE9303	167	C1	PE9396	175	B6	PE9486	149	C2	PE9577	169	A1
PE9214	151	D3	PE9304	167	D2	PE9397	175	D6	PE9487	148	C5	PE9578	169	C2
PE9215	151	C3	PE9305	167	B2	PE9398	168	B5	PE9488	148	D5	PE9579	169	B4
PE9216	161	A2	PE9306	175	D2	PE9399	148	B4	PE9489	161	A5	PE9580	169	D1
PE9217	161	D1	PE9307	175	C2	PE9400	150	A6	PE9490	161	D6	PE9581	152	C2
PE9218	164	C2	PE9308	175	A2	PE9401	152	D3	PE9491	161	D5	PE9582	176	C1
PE9219	164	B2	PE9309	171	D3	PE9402	152	A4	PE9492	162	D1	PE9583	176	A2
PE9220	169	A6	PE9310	171	B3	PE9403	168	B2	PE9493	152	B5	PE9584	176	B1
PE9221	169	D5	PE9311	158	C1	PE9404	168	A3	PE9494	152	B6	PE9585	176	D1
PE9222	173	C6	PE9312	147	A2	PE9405	168	D2	PE9495	152	D5	PE9586	175	A5
PE9223	173	B6	PE9313	161	B4	PE9406	172	C5	PE9496	152	D6	PE9587	175	C5
PE9224	179	C1	PE9314	161	A4	PE9407	153	C1	PE9497	148	A6	PE9588	175	D4
PE9225	168	C3	PE9315	161	D4	PE9408	149	C3	PE9498	149	A1	PE9589	175	B5
PE9226	164	D1	PE9316	161	C4	PE9409	165	C1	PE9499	148	D4	PE9590	147	A4
PE9227	176	D6	PE9317	160	A4	PE9410	165	A1	PE9500	158	B3	PE9591	147	B4
PE9228	177	A1	PE9318	160	D3	PE9411	150	A5	PE9501	156	A3	PE9592	147	D4
PE9229	173	C3	PE9319	160	C4	PE9412	150	C5	PE9502	156	C3	PE9593	147	A5
PE9230	173	B3	PE9320	160	B4	PE9413	168	B6	PE9503	156	B3	PE9594	147	C4
PE9231	173	A4	PE9321	154	D3	PE9414	165	A2	PE9504	156	D2	PE9595	158	A2
PE9232	173	D3	PE9322	154	B3	PE9415	150	B6	PE9505	146	B1	PE9596	150	D2
PE9233	173	C1	PE9323	154	A4	PE9416	175	A3	PE9506	146	D2	PE9597	150	C2
PE9234	173	B1	PE9324	154	C3	PE9417	175	B3	PE9507	146	C5	PE9598	150	A3
PE9235	173	A2	PE9325	154	C4	PE9418	146	C2	PE9508	146	A6	PE9599	150	B3
PE9236	173	D1	PE9326	154	B4	PE9419	168	C5	PE9509	165	C3	PE9600	150	D1
PE9237	160	A6	PE9327	151	A4	PE9420	172	A3	PE9510	165	D3	PE9601	150	C1
PE9238	162	D2	PE9330	153	B4	PE9421	166	B1	PE9511	151	C4	PE9602	150	A2
PE9239	162	C3	PE9331	153	C5	PE9422	153	B3	PE9512	151	A5	PE9603	150	B2
PE9240	171	D5	PE9332	153	D4	PE9423	153	C3	PE9513	151	D4	PE9604	150	D3

# PART NUMBER INDEX

Note: C/R stands for the Column and/or Row location of the specific product on a given page.

Model No.	Page	C/R	Model No.	Page	C/R	Model No.	Page	C/R	Model No.	Page	C/R	Model No.	Page	C/R
PE9605	150	C3	PE9695	146	D5	PE9787	161	B2	PE9863/SF	227	15	PE-B159/RD	181	5
PE9606	150	B4	PE9696	166	B5	PE9788	161	D2	PE9864	227	9	PE-B159/WH	181	6
PE9607	150	A4	PE9697	166	D5	PE9789	161	C2	PE9864/NF	227	3	PE-B159/YW	181	7
PE9608	178	A3	PE9698	166	A6	PE9800	231	38	PE9864/SF	227	6	PE-B305	181	8
PE9609	178	C2	PE9699	163	D6	PE9801	231	27	PE9865	231	21	PE-B400	181	19
PE9610	178	D2	PE9700	164	A1	PE9802	231	16	PE9866	231	39	PE-B405	181	20
PE9611	178	B3	PE9701	165	B6	PE9803	231	35	PE9867	231	34	PE-C100	181	21
PE9612	176	B2	PE9702	150	C6	PE9804	231	24	PE9868	231	28	PE-C195	181	22
PE9613	176	D2	PE9703	151	A1	PE9805	231	13	PE9869	231	17	PE-C200	181	23
PE9614	176	C2	PE9704	160	C3	PE9806	231	40	PE9870	231	23	PE-C240	181	24
PE9615	176	A3	PE9705	166	C3	PE9807	231	29	PE9900	76		PE-C300	181	25
PE9616	178	C3	PE9706	166	D3	PE9808	231	18	PE9901	76		PE-C400	181	26
PE9617	178	D3	PE9707	150	D6	PE9809	231	37	PE9902	76		PE-C500	181	27
PE9618	178	A4	PE9708	151	B1	PE9810	231	26	PE9903	76		PE-C600	181	28
PE9619	178	B4	PE9709	166	A4	PE9811	231	15	PE9904	76		PE-P047	181	29
PE9620	147	B1	PE9710	166	B4	PE9812	231	44	PE9905	76		PE-P047LL	182	1
PE9621	146	B4	PE9711	166	B6	PE9813	231	46	PE9906	76		PE-P086	182	2
PE9622	176	D4	PE9712	166	C6	PE9814	231	41	PE9907	76		PE-P086LL	182	3
PE9623	176	C4	PE9713	164	B1	PE9815	231	30	PE9908	76		PE-P141	182	4
PE9624	176	A5	PE9714	164	C1	PE9816	231	19	PE9909	76		PE-P141LL	182	5
PE9625	176	B5	PE9715	156	D4	PE9817	231	33	PE9910	76		PE-P195	182	6
PE9626	175	D3	PE9716	156	C4	PE9818	231	12	PE9911	76		PE-S330	183	23
PE9627	175	A4	PE9717	156	A5	PE9819	231	31	PE9912	76		PE-SR047AL	183	9
PE9628	175	B4	PE9718	156	C6	PE9820	231	22	PE9913	76		PE-SR047FL	183	10
PE9629	175	C4	PE9719	156	D6	PE9821	231	10	PE9914	76		PE-SR401AL	183	11
PE9630	176	A6	PE9720	157	A1	PE9822	231	8	PE9915	76		PE-SR401FL	183	12
PE9631	176	D5	PE9721	157	B1	PE9823	231	6	PE9916	76		PE-SR402-75	183	13
PE9632	177	B4	PE9722	147	C6	PE9824	231	4	PE9917	76		PE-SR402AL	183	14
PE9633	177	A4	PE9723	147	D6	PE9825	231	2	PE9918	163	D3	PE-SR402FL	183	15
PE9634	177	D4	PE9724	148	A1	PE9826	231	48	PE9930	73	13	PE-SR402FLJ	183	16
PE9635	177	C4	PE9725	148	B1	PE9827	231	47	PE9931-B	73	17	PE-SR405AL	183	17
PE9636	163	B5	PE9726	148	A3	PE9828	231	42	PE9931-R	73	18	PE-SR405FL	183	18
PE9637	163	D4	PE9727	148	C2	PE9829	231	20	PE9932-B	74	5	PE-SR405FLJ	183	19
PE9638	163	A5	PE9728	148	D2	PE9830	231	11	PE9932-R	74	6	RG108A/U	183	24
PE9639	163	C5	PE9729	148	B3	PE9831	231	9	PE9933-B	74	1	RG11A/U	181	9
PE9640	156	B1	PE9730	159	C5	PE9832	231	7	PE9933-R	74	2	RG122/U	182	7
PE9641	146	D4	PE9731	159	D5	PE9833	231	5	PE9934-B	75	1	RG141A/U	182	8
PE9642	146	B2	PE9732	149	B4	PE9834	231	3	PE9934-R	75	2	RG142B/U	182	9
PE9643	147	C2	PE9733	149	C4	PE9835	231	1	PE9935-B	74	7	RG174A/U	182	10
PE9644	154	D5	PE9734	177	C3	PE9836	232	8	PE9935-R	74	8	RG178B/U	182	11
PE9645	154	B5	PE9735	178	A2	PE9837	232	7	PE9936-B	74	3	RG179B/U	181	10
PE9646	154	D6	PE9736	178	D1	PE9838	232	6	PE9936-R	74	4	RG180B/U	182	12
PE9647	154	B6	PE9737	175	A6	PE9839	232	5	PE9950	76		RG187A/U	181	11
PE9648	154	C6	PE9738	175	D5	PE9840	232	4	PE9951	76		RG188A/U	182	14
PE9649	154	B1	PE9739	175	C6	PE9841	232	3	PE9952	76		RG188-DS	182	13
PE9650	154	D1	PE9740	176	A1	PE9842	232	2	PE9953	76		RG196A/U	182	15
PE9651	154	C1	PE9741	177	C5	PE9843	232	1	PE9954	76		RG213/U	182	16
PE9652	154	A2	PE9742	177	A5	PE9844	231	45	PE9955	76		RG214/U	182	17
PE9653	148	C1	PE9743	177	B5	PE9845	231	43	PE9956	76		RG216/U	181	12
PE9654	148	D1	PE9744	177	D5	PE9846	231	36	PE9957	76		RG217/U	182	18
PE9655	148	A2	PE9745	154	C2	PE9847	231	32	PE9958	76		RG218/U	182	19
PE9656	148	B2	PE9746	154	B2	PE9848	231	25	PE9959	76		RG219/U	182	20
PE9657	153	B6	PE9747	154	D2	PE9849	231	14	PE9960	76		RG223/U	182	21
PE9658	153	C6	PE9748	154	A3	PE9850	229	44	PE9961	76		RG225/U	182	22
PE9659	153	D6	PE9749	174	C3	PE9850/2F	229	41	PE9962	76		RG302/U	181	13
PE9660	154	A1	PE9750	168	B1	PE9851	229	38	PE9963	76		RG303/U	182	23
PE9661	155	B4	PE9751	167	C6	PE9851/2F	229	35	PE9964	76		RG316/U	182	25
PE9662	155	C4	PE9752	168	C1	PE9852	229	32	PE9965	76		RG316-DS	182	24
PE9663	155	D4	PE9753	167	D6	PE9852/2F	229	29	PE9966	76		RG393/U	182	26
PE9664	155	A5	PE9754	168	D1	PE9853	229	26	PE9967	76		RG400/U	182	27
PE9665	155	D2	PE9755	168	A1	PE9853/SF	229	23	PE91001	153	A2	RG401/U	183	20
PE9666	155	C2	PE9756	167	D5	PE9854	229	20	PE91002	153	B2	RG402/U	183	21
PE9667	155	B2	PE9757	167	A6	PE9854/NF	229	14	PE91003	153	D1	RG405/U	183	22
PE9668	155	A3	PE9758	172	D1	PE9854/SF	229	17	PE91004	169	C6	RG55B/U	182	28
PE9669	146	C1	PE9759	177	B2	PE9855	229	11	PE91005	151	A6	RG58C/U	182	30
PE9670	146	B6	PE9760	177	D1	PE9855/NF	229	5	PE91006	151	B6	RG58-P	182	29
PE9671	146	C3	PE9761	177	A3	PE9855/SF	229	8	PE91007	151	D5	RG59B/U	181	15
PE9672	156	D1	PE9762	156	D5	PE9856	229	2	PE91028	164	C6	RG59-P	181	14
PE9673	156	B2	PE9763	156	C5	PE9856/NF	228	44	PE91029	165	B1	RG59-WHITE	181	16
PE9674	156	A2	PE9764	156	A6	PE9856/SF	228	47	PE91030	159	A6	RG62A/U	183	1
PE9675	156	C2	PE9765	156	B6	PE9857	228	32	PE91031	160	A1	RG6A/U	181	18
PE9676	153	A6	PE9766	155	C3	PE9857/NF	228	26	PE91032	159	C6	RG6-CATV	181	17
PE9677	153	B5	PE9767	155	B3	PE9857/SF	228	29	PE91033	160	C1	RG71B/U	183	2
PE9678	153	D5	PE9768	155	D3	PE9858	228	41	PE91034	157	B6	RG8A/U	183	3
PE9679	153	C4	PE9769	155	A4	PE9858/NF	228	35	PE91035	158	A3	RG8X	183	4
PE9680	175	B1	PE9770	159	D1	PE9858/SF	228	38	PE91036	150	B5			
PE9681	175	C1	PE9771	159	C1	PE9859	228	23	PE91038	165	D1			
PE9682	147	D5	PE9772	159	A1	PE9859/NF	228	17	PE91039	164	B6			
PE9683	147	A6	PE9773	159	B1	PE9859/SF	228	20	PE91040	158	B1			
PE9684	149	C1	PE9774	146	B3	PE9860	228	14	PE91041	150	D4			
PE9685	157	B2	PE9775	170	A1	PE9860/NF	228	8	PE91042	150	D5			
PE9686	169	D6	PE9776	170	B1	PE9860/SF	228	11	PE91043	150	C4			
PE9687	179	B2	PE9777	170	C1	PE9861	228	5	PE-020SR	183	5			
PE9688	179	A2	PE9778	151	B5	PE9861/NF	227	30	PE-034SR	183	6			
PE9689	179	C2	PE9779	151	C5	PE9861/SF	228	2	PE-047SR	183	7			
PE9690	152	C4	PE9780	170	A2	PE9862	227	27	PE-118SR	183	8			
PE9691	152	D4	PE9781	155	D5	PE9862/NF	227	21	PE-B150	181	1			
PE9692	152	B4	PE9782	155	A6	PE9862/SF	227	24	PE-B159/BK	181	2			
PE9693	152	A5	PE9783	164	C4	PE9863	227	18	PE-B159/BL	181	3			
PE9694	146	A3	PE9786	151	B4	PE9863/NF	227	12	PE-B159/GR	181	4			